



**COMMUNICATION & WORKS DEPARTMENT
GOVERNMENT OF KHYBER PAKHTUNKHWA**

TECHNICAL SPECIFICATIONS FOR WORKMANSHIP

2020

MARKET RATE SYSTEM (MRS)

Contents

CHAPTER – 1	CARRIAGE OF MATERIAL	2
1.1	Mode of Transport	2
1.2	Safe Delivery	2
1.3	Stacking	2
1.4	Carts, Animal Driven Transport, Boat or Steamer Transport	2
1.5	Mode of Carriage	2
1.6	Lead	2
1.7	Measurement	3
1.8	Rate	3

CHAPTER – 1 CARRIAGE OF MATERIAL

1.1 Mode of Transport

Unless otherwise specified or directed in writing by the Engineer In charge, carriage of all materials between stations connected by rail shall be done only by the railway goods train and all rules and regulations in force in the Railway Department in this regard, shall hold good. Other means of transport shall be allowed only when: -

1. The goods train is not available within the stipulated period. In this case a certificate shall have to be recorded by the Engineer in-charge.
2. The railway track is not in order for a certain reason and is expected to take a considerable time before it is put in order.
3. The material to be transported is perishable, and the goods train takes a considerably longer time than the road transport, and thus does not ensure a safe transportation.
4. Any other unforeseen calamity, which in the opinion of the Engineer in-charge is so pressing as to make carriage by road essential.

1.2 Safe Delivery

Whatsoever may be the mode of transport (except goods train) the agency undertaking the carriage of material shall be responsible for its safe loading, unloading, delivery to the specified site within the specified time and stacking, unless it is damaged as a result of a calamity beyond the control of that agency.

1.3 Stacking

The material carted shall be properly stacked at the specified site to the satisfaction of the Engineer in-charge or his authorized subordinate.

1.4 Carts, Animal Driven Transport, Boat or Steamer Transport

When carts, animal driven or mechanical means of transports are engaged for carriage on a daily wage basis, the quantity of material to be conveyed, the distance to be travelled and the number of trips to be made, shall be fixed by the Engineer in-charge or his authorized subordinate.

1.5 Mode of Carriage

Depending upon the feasibility and economy, the Contractor shall propose the mode of carriage viz. whether by mechanical or animal transport and shall be as approved by the Engineer-in- Charge in accordance with corresponding CSR item as provided in Contract Agreement. Contractor should follow the respective items of MRS too differentiate between Kacha road, pacca road, hilly area and plain area.

1.6 Lead

All distances shall be measured over the shortest practical route and not necessarily the route actually taken. Route other than shortest practical route may be considered in cases of unavoidable circumstances and as approved by Engineer-in-Charge along with reasons in writing. Carriage by animal and mechanical transport shall be reckoned in one km unit. Distances of 0.25 km or more shall be taken as 0.50 km and distance of less than 0.25 km shall be ignored.

Carriage by mechanical transport shall be reckoned in one km unit. Distances of 0.5 km or more shall be taken as 1 km and distance of less than 0.5 km shall be ignored. However, when the total lead is less than 0.5 km, it will not be ignored but paid for separately in successive stages of 30 meters subject to the condition that the rate worked on this basis does not exceed the rate for initial lead of 1 km by mechanical.

1.7 Measurement

Carriage shall be contracted for by weight or by volume at a mileage, kilometer or chainage rate or a fixed rate between specified places. In the former case the distance shall be measured by the nearest practicable route, and the miles kilometers and chains measured shall be statute miles kilometers/chains.

1.8 Rate

5. The unit rate shall include loading of material within one chain, carriage to a specified site, unloading and stacking, as per above specifications, within a distance of one chain from the site of unloading.
6. If the lead for loading, unloading and stacking exceeds one chain the payment for additional carriage shall be made whole of the distance and not starting from the second chain.
7. In case of works where item rates include the handling of material up to a certain distance, any extra carriage involved beyond this distance shall be payable at the rate prescribed for the subsequent chain, as case may be.
8. No additional payment shall be made to the contractor for carriage like demurrage, wharf age and toll tax.

Contents

CHAPTER – 2	LOADING, UNLOADING & STACKING	2
2.1	Loading	2
2.2	Unloading	2
2.3	Stacking and Storage of Materials	2
2.3.1	Cement	2
2.3.2	Bricks	3
2.3.3	Blocks	3
2.3.4	Floor, Wall and Roof Tiles	3
2.3.5	Aggregates	4
2.3.6	Steel	4
2.3.7	Aluminium Sections	4
2.3.8	Doors, Windows and Ventilators	4
2.3.9	Roofing Sheets	5
2.3.10	Gypsum Boards, Plywood, Fiberboard, Particle Board, Block Board	5
2.3.11	Glass Sheets	5
2.3.12	Cast Iron, Galvanized Iron and Non -Asbestos Fiber Cement Pipes and Fittings	5
2.3.13	Unplasticized PVC Pipes	6
2.3.14	Bitumen, Road Tar, Asphalt, Etc.	6
2.3.15	Water	6
2.3.16	Oil Paints	6
2.3.17	Sanitary Appliances	6
2.3.18	Other Materials	7
2.4	Measurement	7
2.5	Rate & Payments	7

CHAPTER – 2 LOADING, UNLOADING & STACKING

2.1 Loading

Loading includes mechanical or manual labor for shifting, carrying and lifting of constructional and non-constructional material of all kind, from a place where stacked dumped or scattered in a specified area, to railway wagons or road vehicles and stacking in / on it in the available space to an allowable load carriage capacity, without causing any damage to the items in question to the entire satisfaction of the Engineer in Charge.

OR

Loading of constructional and non-constructional material of all kind on the back of the transporting animals or into the carts driven by animals, from a place where such material is stacked, dumped or scattered in a specified area to another specified destination alone, or in combination to reloading it, to railway wagons or road vehicles and stacking in or on it in the available space to an allowable load carriage capacity, to the entire satisfaction of the Engineer in Charge.

2.2 Unloading

Unloading includes mechanical or manual labor for lifting and carrying of constructional and non-constructional material of all kind, from a place where stacked or dumped in a specified railway wagons or road vehicles and stacking (rate exclusive) in/on it in the available space to an allowable load carriage capacity, to the entire satisfaction of the Engineer in Charge.

OR

Unloading of constructional and non-constructional material of all kind from the back of the transporting animals or from the carts driven by animals, to a place where such material would need to be stacked (rate exclusive) or dumped (rate exclusive), to the entire satisfaction of the Engineer in Charge.

2.3 Stacking and Storage of Materials

Stacking includes the preparation of dunnage under a secured shade to be made for the purpose or at an identified place where shade and dunnage has been made for the purpose, away from the place of loading within a specified distance, with the help of mechanical or manual labor and placing / dumping the material in position, to the entire satisfaction of the Engineer in Charge.

2.3.1 Cement

- Cement shall be stored at the work site in a building or a shed which is dry, leakproof and as moisture proof as possible. The building or shed for storage should have minimum number of windows and close-fitting doors and these should be kept closed as far as possible. Cement shall be stored and stacked in bags and shall be kept free from the possibility of any dampness or moisture coming in contact with them. Cement bags shall be stacked off the floor on wooden planks in such a way as to keep about 150 mm to 200 mm clear above the floor. The floor may comprise of lean cement concrete or two layers of dry bricks laid on well consolidated earth. A space of 600 mm minimum shall be left all around between the exterior walls and the stacks. In the stacks the cement bags shall be kept close together to reduce circulation of air as much as possible. Bowing to pressure on the bottom layer of bags sometimes

'warehouse pack' is developed in these bags. This can be removed easily by rolling the bags when the cement is taken out for use. limbed bags, if any should be removed and disposed off.

- The height of stack shall not be more than 10 bags to prevent the possibility of lumping up under pressure. The width of the stack shall be not more than four bags length or 3 meters. In stacks more than 8 bags high, the cement bags shall be arranged alternately length-wise and cross-wise so as to tie the stacks together and minimize the danger of topping over. Cement bags shall be stacked in a manner to facilitate their removal and use in the order in which they are received; a label showing date of receipt of cement shall be put on each stack to know the age of cement.
- Extra safety shall be exercised in coastal areas, or when it is expected to store for an unusually long period, the stack shall be completely enclosed by a water proofing membrane such as polyethylene, which shall close on the top of the stack. Care shall be taken to see that the waterproofing membrane is not damaged any time during use.

2.3.2 Bricks

- Bricks shall be stacked in regular tiers as and when they are unloaded to minimize breakage and defacement. These shall not be dumped at site.
- Bricks stacks shall be placed close to the site of work so that least effort is required to unload and transport the bricks again by loading on pallets or in barrows. Building bricks shall be loaded or unloaded a pair at a time unless palletized. Unloading of building bricks or handling in any other way likely to damage the corners or edges or other parts of bricks shall not be permitted.
- Bricks shall be stacked on dry firm ground. For proper inspection of quality and ease in counting the stacks shall be 50 bricks long, 10 bricks high and not more than 4 bricks in width, the bricks being placed on edge, two at a time along the width of the stack. Clear distance between adjacent stacks shall not be less than 0.8 m. Bricks of each truck load shall be put in one stack.

2.3.3 Blocks

- Blocks shall be unloaded one at a time and stacked in regular tiers to minimize breakage and defacement. These shall not be dumped at site. The height of the stack shall not be more than 1.2 m. The length of the stack shall not be more than 3.0 m, as far as possible and the width shall be of two or three blocks.
- Normally blocks cured for 28 days only should be received at site. In case blocks cured for less than 28 days are received, these shall be stacked separately. All blocks should be water cured for 10 to 14 days and air cured for another 15 days; thus, no blocks with less than 28 days curing shall be used in building construction. The date of manufacture of the blocks shall be suitably marked on the stacks of blocks manufactured at factory or site.

2.3.4 Floor, Wall and Roof Tiles

- Floor and wall roof tiles of different types, such as, cement concrete tiles (plain, coloured and terrazzo), ceramic tiles (glazed and unglazed) and Porcelain tiles shall be stacked on regular platform as far as possible under cover in proper layers and in tiers and they shall not be dumped in heaps. In the stack, the tiles shall be so placed that the mould surface of one face that of another. Height of the stack shall not be more than one meter. During unloading, these shall be handled carefully so as to avoid breakage.
- Tiles of different quality, size and thickness shall be stacked separately to facilitate easy removal for use in work. Ceramic tiles and clay roof tiles are generally supplied

in cartons which shall be handled with care. It is preferable to transport these at the site on platform trolleys.

2.3.5 Aggregates

Aggregates shall be stored at site on a hard dry and level patch of ground. If such a surface is not available, a platform of old corrugated iron sheets, or a floor of bricks, or a thin layer of lean concrete shall be made so as to prevent contamination with clay, dust, vegetable and other foreign matter. Stacks of fine and coarse aggregates shall be kept in separate stock piles at sufficient distance from each other to prevent the material at the edges of the piles from getting intermixed. On a large job, it is desirable to construct dividing walls to give each type of aggregates its own compartment. Fine aggregates shall be stacked in a place where loss due to the effect of wind is minimum.

2.3.6 Steel

- For each classification of steel, separate areas shall be earmarked. It is desirable that ends of bars and sections of each class be painted in distinct separate colours. Steel reinforcement shall ordinarily be stored in such a way as to avoid distortion and to prevent deterioration and corrosion. It is desirable to coat reinforcement with cement wash before stacking to prevent scaling and rusting. Bars of different classification, sizes and lengths shall be stored separately to facilitate issues in such sizes and lengths so as to minimize wastage in cutting from standard lengths. In case of long storage, reinforcement bars shall be stacked above ground level by at least 150 mm. Moreover, in coastal areas or in case of long storage a coat of cement wash shall be given to prevent scaling and rusting.
- Structural steel of different classification, sizes and lengths shall be stored separately. It shall be stored above ground level by at least 150 mm upon platforms, suitable supports to avoid distortion of sections. In coastal areas or in case of long storage suitable protective coating of primer paint shall be given to prevent scaling and rusting.

2.3.7 Aluminum Sections

Aluminum sections of different classification, sizes and lengths shall be stored separately, on a level platform under cover. The Aluminum sections shall not be pulled or pushed from the stack nor shall be slide over each other, to protect the anodizing layer.

2.3.8 Doors, Windows and Ventilators

- While unloading, shifting handling and stacking timber material, metal and plastic door and window frames and shutters, care shall be taken that the material is not dragged one over the other as it may cause damage to the surface of the material. The material should be lifted and carried preferably flat avoiding damage of corners or sides. Metal and plastic doors, windows and ventilators shall be stacked upright (on their sills) on level ground preferably on wooden battens and shall not come in contact with dirt and ashes.
- Metal and plastic frames of doors, windows and ventilators shall be stacked upside down. These shall not be allowed to stand for long in this manner before being fixed so as to avoid the door frames getting out of shape and hinges being strained and shutters drooping.
- During the period of storage all metal doors, windows and ventilators shall be protected from loose cement and mortar by suitable covering such as tarpaulin. The tarpaulin shall be hung loosely on temporary framing to permit circulation of air to prevent condensation.

- All timber-based frames and shutters shall be stored in a dry and clean covered space away from any infestation and dampness. The storage shall preferably be in well ventilated dry rooms. The frames shall be stacked one over the other in vertical stacks with cross battens at regular distances to keep the stack vertical and straight. These cross battens should be of uniform thickness and placed vertically one above the other. The door shutters shall be stacked in the form of clean vertical stacks over the other and at least 80 mm above ground on pallets or suitable beams or rafters. The top of the stack shall be covered by a protecting cover and weighted down by means of scantlings or other suitable weights. The shutter stack shall rest on hard and level ground.
- If any timber-based frame or shutter becomes wet during transit, it shall be kept separate from the undamaged material. The wet material may be dried by stacking in shade with battens in between adjacent boards with free access of dry air generally. Separate stacks shall be built up for each size and type of material. When materials of different sizes and types are to be stacked in one stack due to shortage of space, the bigger size shall be stacked in the lower portion of the stacks. Suitable pallets or separating battens shall be kept in between the two types of material.

2.3.9 Roofing Sheets

Plastic sheets and Fiber glass sheets shall be stacked under a shed to a height of not more than 0.5 m on a firm and level ground with timber or other packing beneath them.

2.3.10 Gypsum Boards, Plywood, Fiberboard, Particle Board, Block Board

These boards shall be stored flat in a covered clean and dry place. Different sizes and types of each of these boards shall be stacked separately. The board shall be stacked on a flat platform on which a wooden frame shall be constructed with 50 mm x 25 mm battens in such a way that it will give support to all four edges and corners of the boards with intermediate battens placed at suitable intervals to avoid warping. Boards shall be stacked in a solid block in a clear vertical alignment. The top sheet of each stack shall be suitably weighed down to prevent warping wherever necessary. The boards shall be unloaded and stacked with utmost care avoiding damage to the corners and surface. In case of decorative plywood and decorative boards, the surfaces of which are likely to get damaged by dragging one sheet over another it is advisable that these are lifted as far as possible in pairs facing each other.

2.3.11 Glass Sheets

- It is important that all glass sheets whether stored in crates or not shall be kept dry. Suitable covered storage space shall be provided for the safe storage of the glass sheets. In removing glass sheets from crates, great care shall be taken to avoid damages. The glass sheets shall be lifted and stored on its long edges against a vertical wall or other support with the first sheet so placed that its bottom edge is 25 mm from the vertical support. The stacks shall be of not more than 25 panes and shall be supported at two points by fillets of wood at 300 mm from each end. The whole stack shall be as close and as upright as possible.
- The glass sheets of different sizes, thickness and type shall be stacked separately. The distance between any two stacks shall be of the order of 400 mm.

2.3.12 Cast Iron, Galvanized Iron and Non -Asbestos Fiber Cement Pipes and Fittings

- The pipes shall be unloaded where they are required when the trenches are ready to receive them. Storage shall be done on firm, level and clear ground and wedges shall be provided at the bottom layer to keep the stack stable.

- The stack shall be in pyramid shape or the pipes length-wise and cross-wise in alternate layers. The pyramid stack is advisable in smaller diameter pipes for conserving space in storing them.
- The height of the stack shall not exceed 1.5 m. Each stack shall contain only pipes of same class and size, with consignment or batch number marked on it with particulars of suppliers wherever possible.
- Cast iron detachable joints and fittings shall be stacked under cover separately from the asbestos cement pipes and fittings.

2.3.13 Un-plasticized PVC Pipes

- The pipe should be given adequate support at all times. Pipes should be stored on a reasonably flat surface free from stones and sharp projections so that the pipe is supported throughout its length. In storage, pipe racks should be avoided. Pipe should not be stacked in large piles, especially under warm temperature conditions as the bottom pipes may distort, thus giving rise to difficulty in jointing. Socket and spigot pipes should be stacked in layers with sockets placed at alternate ends of the stacks to avoid lopsided stacks.
- It is recommended not to store pipe inside another pipe. Pipe should not be stored in a stressed or bent condition or near the sources of heat. Pipes should not be stacked more than 1.5 m high. Pipes of different sizes and classes should be stacked separately.
- The ends of pipe should be protected from abrasion particularly those specially prepared for jointing either spigot or socket solvent welded joints or shouldered for use with couplings.
- In Dry and Hot conditions, pipes should be stored in shade. In very cold weather, the impact strength of PVC is reduced making it brittle and more care in handling shall be exercised in wintry condition. If due to unsatisfactory storage or handling a pipe becomes kinked, the damaged portion should be cut out completely. Kinking is likely to occur only on very thin walled pipes.

2.3.14 Bitumen, Road Tar, Asphalt, Etc.

All types of bitumen, road tar, asphalt, etc., in drums or containers shall be stacked vertically on their bottoms in up to 3 tiers. Leaky drums shall be segregated. Empty drums shall be stored in pyramidal stacks neatly in rows.

2.3.15 Water

Wherever water is to be stored for construction purposes this shall be done in proper storage tanks to prevent any organic impurities getting mixed up with it.

2.3.16 Oil Paints

All containers of paints, thinners and allied materials shall preferably be stored in a separate room on floors with sand cushions. The room shall be well-ventilated and free from excessive heat, sparks of flame and direct rays of sun. The containers of paint shall be kept covered or properly fitted with lid and shall not be kept open except while using. The containers of paints have expiry date marked by the manufacturers, which should be highlighted so as to facilitate use of paint within due period.

2.3.17 Sanitary Appliances

All sanitary appliances shall be carefully stored under cover to prevent damage. When accepting and storing appliances, advance planning shall be made regarding the sequence of removal from the store to the assembly positions. Supporting brackets shall be so stored as to be readily accessible for use with the appliances.

2.3.18 Other Materials

Small articles like nails, screws, nuts and bolts, door and window fittings, polishing stones, protective clothing, spare parts of machinery, linings, packing, water supply and sanitary fittings, electrical fittings, insulation board, etc., shall be kept in suitable and properly protected store rooms. Valuable small material such as, copper pipes and fittings shall be kept under lock and key.

2.4 Measurement

Measurement shall be taken in units mentioned in the respective BOQ.

2.5 Rate & Payments

Rate shall be calculated as per BOQ, of the actual work done; and payment shall be made against the actual weight, volume, or numbers of material loaded / unloaded or stacked by the contractor / supplier and duly verified and approved by the Engineer in Charge. Deduction shall be charged from the contractor / supplier of the cost of the material if any willful damage has been caused to the material in question by the contractor / supplier or their laborer during loading / unloading or stacking processes. No payment of loading, unloading and stacking will be allowed for any material damaged in the process of load, unload and stacking.

Contents

CHAPTER – 3	EARTHWORK.....	4
3.1	GENERAL.....	5
3.1.1	GLOSSARY.....	5
3.1.2	CLASSIFICATION OF SOIL.....	10
3.1.3	AUTHORIZED OUTLINES.....	12
3.1.4	SITE CLEARANCE.....	12
3.1.5	DATUM.....	12
3.1.6	SETTING OUT.....	12
3.1.7	PROFILE.....	13
3.2	EXCAVATIONS.....	14
3.2.1	TYPES OF EXCAVATION.....	14
3.2.2	EXCAVATION IN FOUNDATIONS.....	16
3.2.3	SHORING FOR FOUNDATION.....	16
3.2.4	EXCAVATED MATERIAL.....	17
3.2.5	FILLING AROUND FOUNDATIONS, FOOTINGS, PIPES ETC.....	19
3.2.6	DEALING WITH BAD SOIL ETC.....	19
3.2.7	TOLERANCES.....	19
3.2.8	TRENCHING/ OPEN CUT EXCAVATION.....	19
3.2.9	MEASUREMENTS.....	25
3.2.9	PAYMENTS.....	25
3.3	EMBANKMENTS.....	26
3.3.1	GENERAL DESCRIPTION.....	26
3.3.2	CONSTRUCTION OF EMBANKMENT.....	27
3.3.3	COMPACTION OF EMBANKMENT.....	28
3.3.4	PRECAUTIONARY MEASURES.....	30
3.3.5	FAILURE OF EARTHEN EMBANKMENT:.....	33
3.3.6	EMBANKMENTS SPECIFICATION.....	34
3.3.7	MEASUREMENTS.....	38
3.3.8	PAYMENTS.....	38
3.4	EARTHWORK FOR REPAIRS.....	39
3.4.1	REPAIRS TO BANK (HOLES AND RAVINES).....	39
3.4.2	SILT CLEARANCE.....	40
3.4.3	MEASUREMENT.....	40
3.4.4	RATE AND PAYMENT.....	40
3.5	EARTHWORK FOR RIVER EMBANKMENTS.....	41
3.5.1	PREPARATION OF SURFACE.....	41
3.5.2	BORROW-PITS.....	41
3.5.3	KEY TRENCH AND SAND CORE.....	41
3.5.4	MEASUREMENT.....	42
3.5.5	RATE AND PAYMENT.....	42
3.6	EARTHWORK ON CANALS.....	43
3.6.1	ACTUAL EXCAVATION.....	43
3.6.2	CONSTRUCTION OF BANKS.....	43
3.6.3	BORROW-PITS.....	43

3.6.4 MEASUREMENT & PAYMENT	44
3.7 CLEARING & GRUBBING FOR ROADS, BUILDING, CANAL ETC.....	45
3.7.1 CONSTRUCTION REQUIREMENTS	45
3.7.2 MEASUREMENT	46
3.7.3 PAYMENTS	47
3.8 REMOVAL OF TREES	48
3.8.1 CONSTRUCTION REQUIREMENTS	48
3.8.2 GENERAL REQUIREMENTS	48
3.8.3 MEASUREMENTS	48
3.8.4 PAYMENTS	48
3.9 EARTHWORK FOR ROADS	49
3.9.1 GENERAL TREATISE OF EARTH/ROAD EXCAVATION AND BACKFILLING.....	49
3.9.2 REMOVAL OF EXISTING PAVEMENTS	52
3.9.3 SCARIFICATION OF EXISTING ROAD / BREAKING OF ROAD PAVEMENT LAYERS	53
3.9.4 ROADWAY AND BORROW EXCAVATION FOR EMBANKMENTS.....	54
3.9.5 EXCAVATION OF UN SUITABLE / SURPLUS MATERIAL	58
3.9.6 STRUCTURAL EXCAVATION AND BACKFILL	60
3.9.7 FORMATION OF EMBANKMENTS.....	66
3.9.8 DEMARCATION OF ROAD ALIGNMENT – SPECIFICATIONS	72
3.10 EARTH FILLING	74
3.10.1 MATERIAL REQUIREMENTS	74
3.10.2 CONSTRUCTION REQUIREMENTS.....	74
3.10.3 MEASUREMENT	76
3.10.4 RATE.....	76
3.11 TERMITE CONTROL	77
3.11.1 PRE-CONSTRUCTION TREATMENT.....	77
3.11.2 MEASUREMENT	77
3.11.3 RATE.....	77
3.11.4 ANTI-TERMITE TREATMENT OF EXISTING BUILDINGS	78
3.12 EARTHWORK BY MECHANICAL MEANS.....	80
3.12.1 EXCAVATORS	80
3.12.2 TRACTOR BASED EQUIPMENT	81
3.12.3 TRANSPORTING EQUIPMENT	81
3.13 EXCAVATION AND GRADING OF ROCKS.....	83
3.13.1 EXCAVATION METHODS.....	83
3.14 HORIZONTAL DIRECTIONAL DRILLING / HDD (TRENCHLESS EXCAVATION).....	86
3.14.1 DESCRIPTION.....	86
3.14.2 APPLICATIONS.....	86
3.14.3 CONSTRUCTION REQUIREMENT	86
3.14.4 MEASUREMENT AND PAYMENT.....	89
3.15 HORTICULTURE.....	90
3.15.1 GENERAL REQUIREMENTS	90
3.15.2 SOIL	91
3.15.3 GRASS PLANTATION (LAWNS).....	92
3.15.4 IRRIGATION WATER	96
3.15.5 LAWN MAINTENANCE DURING PLANT ESTABLISHMENT PERIOD	97
3.15.6 FINAL ACCEPTANCE	97
3.15.7 DECORATIVE BOULDERS.....	97

3.15.8 TREE GUARDS	97
3.15.9 MEASUREMENT AND PAYMENT	98

CHAPTER – 3**EARTHWORK****References:**

Sr.#	Standard Name	Description
ASTM		
1.	ASTM D-4318	Standard Test Methods for Liquid Limit, Plastic Limit, and Plasticity Index of Soils.
AASHTO		
2.	AASHTO T-180 (D)	Standard Method of Test for Moisture–Density Relations of Soils Using a 4.54-kg (10-lb) Rammer and a 457-mm (18-in.) Drop
3.	AASHTO M-145	Standard Specification for Classification of Soils and Soil–Aggregate Mixtures for Highway Construction Purposes.
4.	AASHTO T-191	Standard Method of Test for Density of Soil In-Place by the Sand-Cone Method.
BS		
5.	BS 1377	Methods of test for soils for civil engineering purposes. Chemical and electro-chemical testing.

3.1 General

Earthwork covers any or all works involved in cutting or digging in spoil or soil of various classifications; dressing the excavated pit to the specific grades and dimensions; sorting, transporting and re handling of excavated material; stacking, filling or refilling, compacting and dressing the top and side slopes of the resultant's embankment or spoil bank to the required grades and dimensions, along with all other related operations.

3.1.1 Glossary

Accretion of levels	The rise in the level of the bed of river channel at any site. It is the converse of degradation or retrogression of levels.
Afflux	The rise above the natural surface of water caused by an obstruction in the water way.
Apron	A floor or lining of stone, concrete, etc. to protect a surface from erosion and withstand hydraulic pressure.
Avulsion	The breaking through by a river across the narrow neck of a horse-shoe bend, or the entire change in the course of a river when it breaks through one of its banks in deltaic region.
Back Water (Curve)	The longitudinal profile of the water surface in an open channel where the depth of flow has been increased by an obstruction, an increase in channel roughness, a decrease in channel width, or a flattening of the bed slope.
Bar	A deposit of river borne material at the mouth of a river or b river at the off take of an induction canal.
Bed Load	The detritus (silt, sand, etc.) rolled along the bed of a stream.
Berm	A horizontal ledge on embankment given for the purpose of thickening and increasing "cover" in the rear lower part of a bund
Blow-Out (or sand boil)	An underground leak occurring through a sand stratum under the base or seat of a bund, breaking out through the ground surface on the rear of the bund in the form of a bubbling spring and carrying with it a volume of sand.
Borrow-pits	Pits excavated for obtaining earth required for making embankments.
Breach	A break or gap in the continuity of embankment line through which the river water floods the country on the rear of the bund line. In sindhi it is called gharo or khand. In the USA it is called a 'crevasse'.
Caving	Erosion of a river bank or bund by the undermining action of water, which causes the super incumbent earth to collapse.
Cover	The minimum thickness or height of earth required anywhere over a specified level or line measured vertically or horizontally,

as the case may be. The cover over hydraulic gradient line or saturation line is measured vertically.

Clay	According to the definition of the International Society of Soil Science, all particles of soil less than 0.002 mm in diameter are classified as clay. These soils usually contain about 55% clay, 40% silt (0.002 to 0.02mm) and 5% sand (0.02mm and above)
Creep	The movement of water under or around a structure built on permeable foundation (Also see piping)
Crest	a. The top of the embankment or weir or the highest floor of a regular or sluice at the point of control. It is also called 'crown'. b. The peak of a flood.
Crown	The top of an embankment or bund (also see Crest)
Curtain-Wall	A well provided at the downstream and / or upstream extremity of a sluice or regular to prevent the undermining of the sub-soil by score, piping, or floatation.
Cusec	The unit of discharge used in irrigation practice and meaning a rate of flow of one cubic foot per second.
Cut Off	a. The difference between the water levels upstream and downstream of a regular or an obstruction. b. A channel excavated artificially or formed naturally by avulsion reducing the length of a course of stream or river. c. An anti-creep walls in a sluice or regulator.
Debris or Detritus	Any material, such as floating trash, suspended sediment or bed land, moved by flowing stream.
Delta	The alluvial tract formed by the deposit in the sea of the sediment carried by the river.
Diaphragm wall or core wall	A wall of brick masonry in a section of the bund (especially in very bad and treacherous) to reduce percolation and avoid leaks or to gain sufficient time to close these leaks. (Also See Sand core)
Drop down (Curve)	A form of the surface curve of a river or stream which is convex upward. It is caused by increase in velocity and slope, consequent upon a drop in the water level, or drawdown, such as near or at the entrance to a river "cut-off" or below a flume in a channel. (See Back Water Curve)
Dowel	Short projection extending over a canal bank on its either edge constructed primarily to prevent cutting up of the bank slopes caused by rain. It provides additional safety so far as free board is concerned and also ensures greater safety for wheeled traffic in driving. The usual measurement of the dowel is top width 1.25 feet, height about 1.25 feet and side slope 1 ½:1 with bottom as 5 feet.

Erosion Line	A line ranged at right angles to the general alignment from the toe of the bund to the eroding edge of the pucca bank of the river.
Erosion Ordinate	The measure of the erosion of the line, i.e. the distance from the toe of the bund to the edge of the eroding pucca bank of the river, generally ranged at right angles to the normal alignment of the bund.
Embankment	The earth work above natural ground by deposition of specified materials.
Free Board	The distance between the designed full supply level and the top of the embankment or masonry work left to allow for wave action, floating debris, or any other condition or emergency, without overtopping the bank of the channel or side of the structure. In the case of dams, it is the distance from the top of the dam to the water surface in the reservoir during maximum flood conditions.
Floatation	The undermining caused by the residual force of water, flowing through the subsoil, which acts in the direction of the flow and is proportional to the pressure gradient at that point.
Formation	The top of embankments or bottom of cuttings.
Formation (for Railway)	The top of embankment or the bottom of cutting ready to receive the ballast as denoted by the ultimate grade line or level along the centre line on the longitudinal section.
Formation (Making up Formation for Railway)	It includes: <ol style="list-style-type: none">1. All cutting and embankment necessary to prepare the ground for receiving ballast and track.2. Side and catch water drains.3. Protection measures for cutting and embankments and their slopes.4. Topping embankments with selected material.5. Diversion for roads and streams; and6. All similar works pertaining to the construction of railway line, its siding tracks and station yards.
Groyne	An obstruction of stone, timber or brushwood constructed from the embankment of a river to divert or hold the flow. A stone groyne is called a spur. When constructed parallel to the river flow for protection against wave wash, it is called a "longitudinal groyne", or "muhari"
Guide Bank	A protecting and training bank constructed to guide the river to and from the weir through the water way provided. A river bund may, in effect, be a guide bank when it is at the edge of the river course, there being little or no foreshore between the river course and the toe of the bund.
Hydraulic Gradient Line	In a bund, it is the same as the saturation line (q.v)

Hydrograph	A graph showing the gauge (or discharge) with respect to time.
White Kalar	Main salt: sodium chloride, sodium sulphate and magnesium sulphate. This is the commonest type of kalar in the southern areas.
Abkalani (Sindhi)	The Flood season in which extends from 1 st May to 15 th October depending on monsoon rains.
Dark Kalar	In addition to the salts found in white kalar, it contains the chlorides of magnesium and calcium. It is found on land affected by water logging and seepage.
Black Kalar	It contains sodium carbonate, in addition to salts in white and dark kalar. The large amount of lime present in the soils in southern areas prevents excessive formation of black kalar. This kalar is present in badly drained localities.
Brown Kalar	It contains the nitrates of potassium and sodium in addition to the salts found in white kalar.
Key Trench	An excavation in the base of a bund or other structure filled with specially selected material, generally sand, in case of river bunds to bond the bund in to the ground surface.
Lead-Horizontal	The shortest possible horizontal route between the center of gravity of the material excavated and the center of gravity of the material finally placed in the embankment.
Lead-Total	The horizontal lead as defined above plus the lift converted into horizontal lead, if any.
Lift-Vertical	The vertical difference between the center of gravity of the earth excavated and the center of gravity of the earth placed in the embankment.
Lift into Lead Conversion	Lift shall be converted into horizontal lead with the aid of table appended.
Leak	An increasingly swift passage of water through a hole or cavity in an embankment carrying with it the soil of which the embankment is build. The hole itself is also referred to as leak.
Loop Bund	Where there are two lines of defense, the bund line constructed on the rear or on the side of the land is generally called loop bund. (The first line is called the front bund) if the first line of defense is eroded or abandoned the loop bund may become the front bund, or vice versa. If another line of defense is constructed on the side of the river the front bund (so called prior to this new construction) become the loop bund.
Main Bund	The embankment which forms the principal line of defense, e.g. in a composite bund with wetting channel it is the bund on the rear on the side of the land of the wetting channel.

Over-topping	River or canal water running over the top of the bank.
Piping	The flow of water under or around a structure build on permeable foundation which, if not prevented or stopped, will remove material from beneath the structure and cause it to fall. The erosion of sub-soil by high velocities of flow of water through it, when such velocities exceed a certain limit, is also referred to as piping.
Porosity	An Index of void characteristic of a soil or stratum as it pertains to percolation and degree of preciousness.
Retrogression	The lowering of the specific levels, i.e. of the level of water surface of a channel for a given discharge.
Soil	Sediments, or other unconsolidated accumulation of solid particles produced by the physical and chemical disintegration of rocks, and which may or may not contain organic matter.
Sand	According to the definition of the International Society of Soil Science, coarse river or canal sediment of size 0.02 mm up to 2.00 mm in diameter is called sand. Sandy soil contains up to about 5% clay, 0.002 mm in diameter or less, 10% silt, 0.002 to 0.02 mm in diameter, and 85% sand of 0.02 to 2.00 mm in diameter.
Sand Core	A hearting or core of pure sand provided in the bund section, particularly in Kalar, hard clay or bad soil and is intended to prevent or reduce leakage and rat holes through the bund section.
Seepage	The percolation of water through embankment or soil.
Saturation Gradient	The slope of the top-most seepage line, or the surface of the percolating water, through the cross section of the embankment (Also see hydraulic gradient line)
Slip or Slide	Where the Saturation Gradient intersects the downstream slope or face, and water crops up making the lower part pasty, the dry-earth slips or sloughs over the saturated earth, squeezing it out. This leads to slides or slips, fast endangering the stability of the bund.
Silt	According to the definition of the International Society of Soil Sciences, all particles of the soil from 0.002 mm to 0.02 mm in diameter are classified as silt. Silty soil contains up to about 20% clay of 0.002 mm in diameter and less; 45% silt of 0.002 to 0.02 mm in diameter; and 35% sand of 0.02 mm in diameter and above.
Wave Wash	The damage done to the bund when the flood water strike and splash on their upstream face unless counteracted by jungle or Pilchi pitching or other artificial devices.

Weep Holes Opening left in diaphragm walls, pitching etc., to permit drainage and wet the earth on their rear side or on the side of the land, so as to reduce unequal pressures owing to saturated earth on one side and dry earth on the other.

Wetting Channel A device used for soaking (staunching) or preparing a bund in advance of the main rise of the river, for its task of holding back the river. It refers to both the gravity channel, from the river lip to the channel between the trench bund and the main bund through which water is pumped to soak the main bund.

3.1.2 Classification of Soil

The formation of soil varies from place to place and usually the soil of the following classification is found in various parts of Pakistan.

1. **Soft Soil:** It comprises sand, silt and those soils, which offer no resistance to excavation and some time, require shoring when foundations of exact dimensions are required to be excavated. Ordinary kassi (Phawarah) shovel or spade can be used for excavation in such soils.
2. **Ordinary Soil:** It comprises earth and sandy loam, spoil or rubbish of every description and any other formation into which a spade and kassi (Phawarah) pick or shovel can excavate.
3. **Hard Soil:** It comprises stiff and heavy clayed soil having specific gravity of 1.5 and above and at times having small percentage of kankar or boulders mixed up. It can be excavated by repeated blows of kassi or with pick or shovel.
4. **Very Hard Soil:** It comprises hard moorum with high percentage of kankar or boulders, mud concrete, shale lime or concrete, conglomerate formation, brick work in lime, stone masonry in lime, metaled surface of road (tarred or untarred), hard core under floor and road bottoming, and other formation into which a spade cannot enter and whose excavation requires the forcible application of a pick.
5. **Gravel Work & Soft Rock not requiring Blasting:** It comprises gravel formation, cement concrete, brickwork in cement, soft varieties of lime stone, sand stone, fissured stone or any other formation which can be excavated by the use of pick, shovel, jumpers, wedges, hammers, etc. and do not require blasting.
6. **Rock requiring Blasting:** It comprises hard stratified rock like compact hard lime stone, hard sand stone or un fissured and un stratified masses like granite and basalt (rap) etc. or similar formation for the excavation of which blasting is required. Rocks falling under this class are sub-divided into six grades (Please see table 10 of heading 3.13 of these specifications) depending upon the degree of toughness.
If it is apprehended that blasting may prove harmful to nearby buildings or structures, other methods such as cutting out by means of chisel, wedge, pneumatic concrete breaker, sledge hammer or heavy points are normally adopted.
7. **Slush:** The above classification of soil related to dry excavation which extends up to a depth of 6 inches below the sub-soil water level. Beyond this depth the soil is said to be wet up to a depth which permits the laborer to work in the pit without getting themselves sunk into it. When the wet soil is so composed that it cannot support the weight of laborer working in the pit and the excavated material sticks to the implements used for digging, it is called slush and has an angle of repose less than 25°. Wet soil shall start from half foot below the sub-soil water level and shall go down till it can support man's weight.

AASHTO Soil Classification System (from AASHTO M 145)											
General Classification	Granular Materials (35% or less passing the 0.075 mm sieve)							Silt-Clay Materials (>35% passing the 0.075 mm sieve)			
Group Classification	A-1		A-3	A-2				A-4	A-5	A-6	A-7
	A-1-a	A-1-b		A-2-4	A-2-5	A-2-6	A-2-7				A-7-5 A-7-6
Sieve Analysis, % passing											
2.00 mm (No. 10)	50 max	--									
0.425 (No. 40)	30 max	50 max	51 min	--							
0.075 (No. 200)	15 max	25 max	10 max	35 max	35 max	35 max	35 max	36 min	36 min	36 min	36 min
Characteristics of fraction passing 0.425 mm (No. 40)											
Liquid Limit	--	--	40 max	41 min	40 max	41 min	41 min	40 max	41 min	40 max	41 min
Plasticity Index	6 max		N.P.	10 max	10 max	11 min	11 min	10 max	10 max	11 min	11 min
Usual types of significant constituent materials	stone fragments, gravel and sand		fine sand	silty or clayey gravel and sand				silty soils		clayey soils	
General rating as a subgrade	excellent to good							fair to poor			
PI of A-7-5 subgroup is equal to or less than LL-30			PI of A-7-6 subgroup is greater than LL-30								

Table 1, AASHTO Soil Classification System (from AASHTO M 145)

3.1.3 Authorized Outlines

Unless otherwise specified or directed by the Engineer-in-charge in writing all earthwork viz excavations, holes, trenches for foundations, filling etc. shall be executed to the widths, length, depths, alignments, grades and levels shown on the approved drawings. If they are not indicated on the drawing, they shall be carried out to the profile agreed to by the Engineer in charge in writing before the commencement of work.

3.1.4 Site Clearance

The surface area of the ground to be occupied by the proposed buildings shall be cleared off roots, grass, shrubs, brush, trees, fences, walls, buildings, roads, ruins and such other structures as may either cause hindrance in the execution of work or may decay and form dangerous pockets. Such works can be classified beforehand into following categories by the Engineer in-charge for the purpose of making payment.

- A. Stripping of grass, uprooting bush stumps having girth and roots less than 3 feet and diameter less than six inches and their number not exceeding 200 per acre. The cost of this item is included in the unit rate of earthwork.
- B. Jungle clearance – Removal of roots, bush stumps, shrubs, trees and jungle. The Engineer in charge shall decide, on the basis of the actual sizes and concentration of such material, whether rate for ordinary jungle clearance or heavy jungle clearance is to be paid. His decision shall be final.
- C. Demolition of fences, walls, buildings, roads and other structures shall be paid according to the relevant item under the chapter “Dismantling”. The rates for these works shall clearly state:
 - i). The disposal of materials obtained during the operation of site clearance.
 - ii). Whether or not, it shall be a “set off” against the cost of site clearance. In the absence of such clarifications the materials shall be the property of government.
 - iii). That any damage to the works and public or private property caused by the contractor’s operation in clearing shall be repaired or replaced at his expense.

3.1.5 Datum

Any bench mark, which is to be used for the work, shall be correctly related to the datum specified on the approved drawing or fixed by the Engineer in-charge and the contractor shall make and maintain at his own cost all such permanent bench marks required for the proper execution of works in the vicinity thereof, in perfect order to the satisfaction of the engineer-in-charge.

3.1.6 Setting Out

1. Before commencing actual execution, the central line of the excavation shall be distinctly marked with a deep furrow (dagbel) at least 9-inch-wide and 6 inches deep and pegs shall be fixed at every Centre line. In the case of the excavation of foundation, the Centre, longitudinal or face line and at least one main cross line, shall be marked by means of masonry pillars built clear of the point to which the slopes of the excavation shall extend. On each pillar, there shall be an accurate mark to enable a surveying instrument to be set up over it for setting out purposes.
2. In the case of the excavation of foundation, the center, longitudinal or face line and at least one main cross line, shall be marked by means of masonry pillars-built clear of

- the point to which the slopes of the excavation shall extend. On each pillar, there shall be an accurate mark to enable a theodolite to be set up over it for setting out purpose.
3. All these operations involved in setting out are included in the unit rate for earthwork.

3.1.7 Profile

Having marked the alignment, a complete profile of embankment or cutting, as the case may be, shall be set out at fifty feet intervals of every change of section, and also at every curve. This profile shall have a linear dimension of 10 feet, its excavation shall be dug to the proper level and bank through up to the correct height, width and all slopes dressed to true form. The correct height of this profile shall be 10% more than desired final level of the embankment so that it may take care of shrinkage and settlement. The end of all the profile banks shall be stepped so that proper locking takes place at the time of the construction of the bank adjoining them. All labor and implements like bamboos, stakes, strings, pegs, batter boards, etc., required for fixing profile shall be supplied by the contractor and the cost is included in the initial rate.

3.2 Excavations

All excavations and earthwork shall be performed and executed in accordance with stipulations (specifications) and requirements set forth here which shall apply except when they are specifically modified in writing by the Engineer-in-charge for any particular item. The method of carrying out earthwork shall be subject to the approval of the Engineer in-charge in writing.

3.2.1 Types of Excavation

Broadly speaking all excavations (digging or cutting) can be grouped as (a) Precise excavations (b) Borrow-pit excavations.

3.2.1.1 Precise Excavation

Excavation for attaining certain definite levels, grades and dimensions shown in the drawings such as excavation for foundation of various types of building, irrigation structures; cutting for rail and road formations; excavation for key trenches, irrigations channels, drains, sewer for other similar works; remodeling, regarding or desilting of existing channels and reconditioning of the choked drains and sewer etc. are known as precise excavation. These excavations are usually done in uniform lifts, reach by reach, and in such a fashion that they drain themselves automatically.

It is advisable to dig out a central trench first and then proceed to dress the sides to the required slopes by cuttings. In all such cases the formations levels are observed before and after the actual excavation to adjudge the accuracy of the cutting. Any excess cutting has to be made good with selected material thoroughly compacted under instructions of the Engineer in Charge.

The material obtained from these excavations may be disposed off in any of the following manners: -

1. Finds like antique relics, coins, fossils, which normally cannot be used in the work or deposited with Government store under directions of the Engineer in Charge.
2. Suitable excavation material may be used in raising dams, embankments, ramps, rail and road formations or refilling the voids of foundations after the erection of the structure.
3. Excavated material considered unsuitable for any of the above usages or rendered surplus, is usually dumped in spoil banks properly dressed under the directions of the Engineer in Charge.

3.2.1.2 Borrow-Pit Excavation

The excavations which are necessitated for procuring suitable and adequate materials for raising dams, embankments, core walls, ramps, rail and road formations or refilling the voids of foundations after the erection of the structure or for other allied purposes are known as borrow-pit excavations.

The following factors govern the locations, spacing and dimensions of borrow-pits.

1. Type and quantum of earth to be procured.
2. Type of embankment for which borrow-pit have to be dug.
3. Safety of the existing works or new works under construction.
4. Subsequent use of land under borrow-pits.
5. Ease in recording and checking the measurement of the quantity of excavated materials.

6. Mode of excavation (By machine or manual labour.)

Borrow-Pit Essential Requirements

1. Borrow-pits shall be located well away from the embankment so that they do not cut the hydraulic grade line of the resultant embankment but leaves some cover above it.
2. The borrow-pit are shall be clearly demarcated by a dagbel before commencing any digging. If old borrow-pits already exist in the demarcated area, they shall be measured and their measurement recorded. Size, configuration and distinctive marks in the new borrow-pits shall be so fixed that they do not get mixed up with the old ones.
3. No borrow-pit shall be excavated beyond the specific limits, or close to an existing road village track, embankment and other structure which are liable to be damaged.
4. For storage dams, borrow-pit in the reservoir shall not be dug nearer Than twice the height of the dam from its front toe.
5. Borrow-pits shall not as far as possible be excavated on the land side of a river embankment because that would increase the infiltration head acting on the embankment and may cause it to leak. On the river side it shall not be nearer Than 100 feet for repair and 150 feet for new construction from the toe of the embankment. Borrow-pits 150 to 200 feet, shall not be more Than 6 feet deep; 200 to 300 feet not more Than 8 feet deep; and beyond 300 feet may be of any depth.
6. Borrow-pits shall not be nearer Than 30 feet from the toe of a big canal bank, and 10 feet from the toe of a small channel bank of their depth does not exceed 2 feet. If the depth exceeds 2 feet, the minimum distance recommended from the toe of the bank of a small channel is 15 feet.
7. Borrow-pits shall be as follow as possible so that the land can be subsequently ploughed over and brought under cultivation. In cultivated areas, where lands have been temporarily acquired, the depth shall not be more than one foot; otherwise the maximum depth is 3 feet. No pit shall be excavated more than 5 feet with in the distance of 300 feet from the toe of an embankment.
8. Borrow-pits shall not be continuous or otherwise they will form a channel. At least 10 feet wide strip shall be left unexcavated in every chain or so.
9. A space of about 5 feet shall be left around all pits for laborer to pass.
10. Borrow-pits shall in multiple of 10 feet length to facilitate recording and checking the quantity of the excavated material.
11. No borrow-pit shall be dug in the central portion of a channel berm not in a canal bed below the bed level except as detailed below. Where the earth has to be borrowed from near a canal bank, the pits shall not be more than 6 in deep.
12. In the case of large channels, borrow-pit can also be dug in the bed leaving 5 feet berm from the inner toe of the banks on either side and a width equal to half the length of the pit between each pit. The width of pits shall not exceed half the bed width of the channel and depth 1 to 2 feet below the bed. Pits shall not be dug near any masonry works or within 20 feet of the footpaths or cattle tracks crossing a channel since they tend to cause the inner slopes to the channel to slip down. These pits get silted up as the channel runs for a couple of months. No pit shall be dug in beds of channel in which no silt is ordinarily deposited.
13. Borrow-pit may be dug in berm where they are very wide and likely to slit up rapidly. The earth shall ordinarily be obtained by cutting vertical pockets, whose long lengths shall never be dug down to below bed level. The length of pockets shall not exceed the bed width of the channel or 10 feet, whichever is less spaces left between the pockets shall not be less than 5 feet wide.
14. Before digging any material for filling in the embankment, the entire surface of the borrow-pits shall be cleared of all grass, roots, shrubs, jungle, or any other organic matter liable to decay and form dangerous pockets.

3.2.2 Excavation in Foundations

1. The bottom and side slopes of excavation, upon or against which structures or other required constructions are to be placed, shall be finished accurately to the required grades and dimensions, and if required by the Engineer in-charge, shall be moistened with water and tamped or rolled with suitable tools or equipment for the purpose of forming a firm foundation.
2. Whenever the natural foundation material is disturbed or loosened or excavated beyond the approved lines and grades, the loose material shall be removed and the extra excavation made good at contractor's expense with selected material which shall be thoroughly compacted by tamping or rolling in layers not exceeding 6 inches.
3. If at any point in the excavation, material unsuitable for foundation is encountered, as determined by the Engineer in-charge, he shall direct in writing its removal and excavation shall be filled with selected materials thoroughly compacted by tamping or rolling in layers not exceeding 6 inches. The cost of this replacement with selected materials shall be paid under the rate for earthwork compacted.
4. When a safe and solid foundation cannot be obtained at the depth shown on the approved drawings, special measures (to be determined in all cases by the Engineer in-charge) may be taken under a special agreement reached beforehand.
5. No excavated earth shall be heaped within 20 feet of the top edge of any foundation.
6. Foundation trenches shall be inspected and approved by the engineer-in-charge before foundation is laid.
7. All excavations shall be kept free from water from whatever source it may come at all times to the entire satisfaction of the engineer-in-charge except where otherwise specified or permitted in writing by him.
8. The surface water if and when accumulated shall be dried by the contractor at his own cost. As for the subsoil flow water, separate item of dewatering/lowering of water table should be provided and paid for.
9. All swamps, drainage channels, etc., when no longer required, shall be filled in with concrete or other suitable material to the satisfaction of the engineer in-charge.
10. Materials which do not stand on the slopes shown on the drawing or established by the engineer in charge and the which are a part of slides extending beyond the established lines of excavation bit are left into excavated areas, shall be removed by the contractor in an approved manner, and the slopes shall be re-finished to lines and grades established by the Engineer-in-charge, the contractor may be required to excavate potential slides area beyond the limits of the originally staked excavation, if in the judgment of the Engineer-in-Charge, such excavation is necessary to prevent damage to the work.

3.2.3 Shoring for Foundation

1. The contractor shall provide all timbering, steel sheet piles, or other approved supports, and shore the side of excavation, trenches, pits and walls, in such a manner as will be sufficient to secure them from falling and prevent any movement.
2. Shoring shall consist of frames of vertical and walling pieces supported by struts. These shall hold the laggings in position against the sides of the excavation. Laggings shall be further secured by wedges driven firmly down between the frame and the laggings. Scantling shall vary according to the foundation and their sizes shall be fixed by the engineer-in-charge. Struts and frames shall be secured together by iron dogs and bolts, where necessary. In the case of deep foundation, additional vertical uprights shall be attached to the walling by iron dogs.

3. **Excavation shall proceed as follows:** When the sides of excavation show signs of caving in, the first frame and the first set of short-laggings shall be put in. The laggings shall be long enough to stand about 4 feet out of the ground. Wedges shall be driven in and excavation proceeded with. As excavation proceeds, two men on the top and two men below shall drive down each lagging separately, after drawing the wedges. When each lagging has been driven down as far as it can go, the wedge shall be replaced and the next lagging driven down in the same way and so on. If the soil is dug away from under each lagging, the latter shall drop down in most cases without the aid of a mallet. Laggings shall be kept plumb and touching each other, otherwise it would be difficult to get the next frame in. When excavation has reached the full length of laggings, they shall be drawn out cautiously one by one, and the longer ones shall be put in or a fresh row driven inside the others. Excavation may then go down to the depth required; the frames being put in at least every 5 feet vertically. When concrete or masonry work is in progress, the process shall be reversed; the laggings shall be prized up one by one and the frames withdrawn as masonry is raised up.
4. Any cheap wood, cut in 6 inches or 7 inches planks, 1½ inch to 2-inch-thick, shall be used for lagging. The frame shall, however, be of sound wood that does not warp.

3.2.4 Excavated Material

All suitable materials obtained from excavation shall be used in filling. Wherever practicable, all materials shall be placed in the designated final locations direct from excavation, except that the backfill material, when so directed by the engineer-in-charge, shall be placed in temporary stock piles and later placed in the designated locations. As far as practicable, as determined by the engineer-in-charge, all materials designated for use in compacted embankments and plinth shall have the proper water content either by sprinkling or other suitable means before and during excavation or after placing:

1. All fill or refill around structures i.e. within the slopes and limits of the established lines for excavation for the structures and below the natural surface level, shall be placed as backfill or compacted backfill; and all fill or refill about structures i.e. above the natural surface level shall be placed as embankments or compacted embankments, except as otherwise specifically shown on the drawings or provided in these specifications.
2. If sufficient suitable materials are not available from the required excavations to construct the embankment, backfill and other earthwork construction shown on the approved drawings or directed in writing by the Engineer-in-charge, suitable materials shall be transported from the nearest location.
3. Excavated materials containing stumps, roots, vegetable matter and other objectionable material that are otherwise unsuitable or not required for backfill, roads or in any other permanent construction required under these specifications, shall be disposed of as directed in writing by the Engineer-in-charge.
4. Materials of any kind such as shingle or hard good quality stone, obtained from excavation, as also any find made on the site such as antique, relics, coins, fossiles, etc. shall remain the property of the government. The rate includes the separation of the aforementioned materials and finds from each other and their depositing, as directed by the engineer-in-charge. Any of these materials, if ordered by the engineer-in-charge to be used by the contractor on the works, shall be charged to him at the rates to be agreed upon between engineer-in-charge and the contractor before the materials are used.

3.2.4.1 Classification of Excavated Material

Excavation shall be classified under the following heads for recording measurement and making payment:

1. **Soft soil.** It includes all cutting in sand, silt and those soils, which offer no resistance to excavation and sometimes require shoring when foundation (of buildings etc.) of exact dimensions is required to be excavated since they have small angle of repose.
2. **Ordinary soil.** It includes all cutting in earth which can be ploughed, irrespective of the fact whether picks or “phawarabs” have been used in the actual excavation. Usually it includes:
 - i). Spoil or rubbish of every description.
 - ii). Earth and sandy loam.
 - iii). Any other formation into which a spade can be entered and can be easily excavated by the application of kassi, pick or shovel.
3. **Hard soil.** There are the following two types of hard soil:
 - i). It includes stiff and heavy clay soil having specific gravity of 1.5 and above, which can be dug with repeated blows of kassi or pick axe.
 - ii). Soil having small percentage, say up to 15% of kankar or boulders which can be easily dug and removed along with the soil.
4. **Very hard soil.** The following types of soil fall under this definition:
 - i). It includes hard moorum with high percentage of kankar (more than 15%) or boulder (less than 20%), which can be individually lifted by hand.
 - ii). Mud concrete.
 - iii). Conglomerate formation, shale lime concrete, brickwork in lime and stone masonry in lime.
 - iv). Metaled surface of the road (tarred or untarred).
 - v). Hard core under floor and road bottoming.
 - vi). Any other formation into which a spade cannot enter and the excavation of which requires the forcible application of a pick.
5. **Shingle, Gravel work and rock not requiring blasting.** This type includes:
 - i). Gravel formation, cement concrete, brickwork in cement mortar.
 - ii). Large boulders above 20 per cent which can be individually lifted by hand.
 - iii). Soft varieties of limestone, sandstone or fissured stone or any other formation which can be excavated by use picks, jumpers, shovels, wedges, hammers, etc. and do not require blasting.
 - iv). Soils which contain more than 50% of larger than 1-2” size particles of gravel and kankar etc., and is such as can be removed with a spade i.e. is in a semi compact state and requires more labour to excavate than the soft or hard soil will be classed as gravelly soil, stretches where gravel may be found in a loose state which can be picked up by spade or can be easily removed with pick axe as hard soil will not be classed as gravelly soil but as soil or hard soil as the case may be.
6. **Rock requiring blasting.**¹ This includes hard stratified rock, like compact, hard limestone, hard sandstone or un-fissured and unstratified masses like granite and

¹ Blasting shall not be performed without the prior written permission of the engineer-in charge. The contractor shall check all necessary precautions for the safety of person and property etc. as required by the engineer-in-charge and shall obey all instructions as may be issued by the Engineer in-charge.

basalt (trap), etc. or similar formation for the excavation of which blasting is required since they cannot be excavated by jumpers, wedges, hammers, picks etc.

Rocks falling under this class can be further sub-classified into 6 grades. Refer to table No. 10 of heading 3.13 of these specifications.

7. **Rock requiring blasting but blasting prohibited.** This includes all as No. (vi) above, where blasting is prohibited by the engineer-in-charge. Blasting is prohibited when it is apprehended that it may cause harm to important buildings or other works located nearby. In that case other methods such as cutting out by means of chisel or wedges, pneumatic concrete breakers, sledge hammers and heavy points are normally adopted.
8. **Wet.** A soil shall be classified as wet when on being taken in a piece of cloth and pressed by hand, wets the cloth.
9. **Wet (slush).** Wet soil when so composed that it cannot support the weight of laborer working into the pit and excavated material sticks to the implements used for digging, shall be classed as slush and paid accordingly.

3.2.5 Filling around Foundations, Footings, Pipes etc.

After the foundation structural works within excavations have been inspected and approved by the engineer-in-charge excavations shall be refilled with selected material, taken from excavation, if so authorized by the engineer-in-charge duly compacted in layers not exceeding 6" in thickness to the density 90% of max dry density as per AASHTO T- 180(D). Material shall be placed with care around pipes to avoid damage. When the superstructure of a building is higher than the plinth level, the plinth area shall be filled in with excavated material if approved by the engineer-in-charge. 6" layers duly compacted as mentioned above or with any other selected material as may be specified, for which extra payment shall be made.

3.2.6 Dealing with Bad Soil etc.

A soil that the engineer-in-charge may deem unsuitable shall be removed from the surface to be covered by the backfill. This earth shall be disposed of as directed by the Engineer-in-charge and shall be measured up and paid for separately. If the Engineer-in-charge directs the removal of any unsuitable material its measurement shall be taken first and recorded in the measurement book.

3.2.7 Tolerances

The canal prisms shall be excavated and uniformly competed to the prescribed lines, dimensions and grades of the canal sections given on drawings or established by the Engineer in Charge; however, to facilitate for the canal prisms and to allow for inaccuracies in the methods of excavation, the contractor may at his own option and at his own expense over-excavate the bed level and side slopes of the canal prisms in an amount not to exceed three (3) inches measured vertically. Minor deviations in the bed level and side slopes of the canal prisms within short reaches as approved by the Engineer will be permitted to extend into designated canal prism an amount not to exceed three inches measured vertically. Abrupt changes in the surfaces of the side slopes of the canal prism will not be permitted. Gouges, borrows and ridges resulting from excavation operations will be permitted in and on the excavated surfaces of the canal beds and side slopes in an amount not to exceed three inches measured vertically only when approved by the Engineer.

3.2.8 Trenching/ Open cut Excavation

3.2.8.1 General

1. Description

The Work under this Section includes providing all labor, materials, tools and equipment necessary for the excavation and backfill required for installation of pipelines, manholes, vaults, diversion structures, and other appurtenances; and for ground surface restoration, including pavement. Depth for trench shall be according to the drawings and BOQ item.

3.2.8.2 Materials

1. Trench Excavation

Trench excavation shall consist of all material, of whatever nature.

2. Bedding

Bedding, Class A, shall be aggregate conforming to the following gradation: -

Sieve Designation	Percent Passing by Weight
1-1/2"	100
No. 4	0-35
No. 200	0-8

Table 2, Aggregate Gradation (Chapter-3)

- Bedding, Class B, shall be three inch minus material, free of muck, frozen material, lumps, organic material, trash, lumber or other debris, with no more than eight percent passing the No. 200 screen.
- Bedding material for pipe placement shall be non-frost susceptible material.

3. Backfill

Backfill is a material placed above the level of bedding material. Backfill material consists of native material excavated from the trench that is determined by The Engineer to be suitable as backfill. Backfill material used under asphalt or concrete pavement, as shown on the Drawings, shall be non-frost-susceptible, granular material that is free of rocks larger than six inches, much, frozen material, lumps, organic material, trash, lumber, or other debris. All backfill material available from trench excavation shall be utilized prior to the use of the imported backfill.

4. Imported Backfill

Imported backfill shall be granular material, free draining, free of much, frozen material, lumps, or organic material and shall conform to the following gradation: -

Sieve Designation	Percent Passing by Weight
3	100
No. 4*	20-70
No. 200*	0-6

Table 3, Aggregate Gradation (Chapter-3)

*Gradation shall be determined on that portion passing the three-inch screen.

5. Aggregate Base

Aggregate base shall conform to the requirement of heading 16.3.2 of chapter 16 of these specifications.

6. Asphalt Concrete Pavement

Asphalt concrete pavement shall be restored keeping the specifications of chapter 16 in mind.

7. Portland Cement Concrete

Portland cement concrete shall conform to the specifications of chapter 6 of these specifications.

3.2.8.3 Construction Requirements

1. Excavation

- Prior to excavating trenches, all necessary clearing and grubbing shall be completed in accordance with the provisions of heading 3.7 of these specifications.
- Excavation for trenches shall conform to the lines and grades shown on the Drawings and to the limits depicted in the Standard Details. The Contractor shall also do any Work necessary to prevent surface water from entering the trench.
- Excavation of any and all material more than six inches below the invert of the pipe as shown on the Drawings shall be done only when ordered in writing by the Engineer. The material so excavated will be handled in the manner described below: -
 - ✓ All excavated material suitable for use as backfill shall be piled in an orderly manner separately from unsuitable material, at a sufficient distance from the edge of the trench to prevent material from sloughing or sliding back into the trench. When the trench is in a traveled roadway the Engineer may require removal and temporary storage of excavated material elsewhere.
 - ✓ Materials unsuitable for use as backfill shall be hauled to a Contractor furnished disposal site off of the Project, unless otherwise directed in writing by the Engineer. The Contractor is responsible for securing waste disposal sites if none is indicated on the Drawings. The Contractor shall obtain the written permission of the landowner for use of all disposal sites, and shall either obtain any required permits or assure that they have been obtained by others. If requested by the Engineer, the Contractor shall furnish the permit numbers of all required permits for the disposal sites. The cost of securing such sites shall be borne by the Contractor.
 - ✓ If the Contractor fails to comply with the provisions of any country regulation pertaining to waste disposal or disposal sites, the Owner shall have the right, after giving 30 days written notice, to bring the disposal sites into compliance and collect the cost of the Work from the Contractor, either directly or by withholding monies otherwise due under the contract. No more than 150 feet of trench shall be open in advance of laying the pipe, and no more than ten feet of trench shall remain open at the end of each working period. When the trench is in a traveled roadway, it shall be completely backfilled, in accordance with the Specifications, and opened to traffic at the end of each working period, unless otherwise approved by the Engineer.
- If explosives are used, the Contractor shall take the necessary steps before carrying out the work.
- The Contractor shall protect and preserve all existing pavement not designated for replacement, throughout the entire construction period. No tracked equipment may be

operated on any pavement without first protecting the pavement with pavement pads approved by the Engineer. All pavement which is damaged in any manner by the Contractor's operations shall be restored to original or better condition at the Contractor's expense.

- Where required to prevent caving of the trench, or by any safety law or regulation, the Contractor shall furnish and install bracing and/or sheeting to protect the excavation. This bracing and/or sheeting shall be removed as trench backfill progresses.
- The Contractor shall remove and dispose of all water entering the excavation. Disposal of water shall be done in a manner to prevent damage or nuisance to adjacent property, and in accordance with all applicable laws and regulations. Pumps shall be adequate to maintain a dry trench during the bedding, pipe installation, and initial backfill to an elevation at least one foot above the top of pipe. No backfill may be placed in standing water under any circumstances, except when the Drawings and/or Specifications specifically permit installation of HDPE water pipe in a wet trench.
- Excavations for manholes and similar structures shall be large enough to provide proper working room. Any over depth excavation shall be backfilled with concrete or other approved material at the Contractor's expense.
- The Contractor shall provide temporary support of existing structures, as necessary, to protect the structures from settlement or other disturbances caused by construction activities. All structures disturbed by the Contractor's activities shall be returned to original condition, or better.

2. Bedding

- Bedding shall be placed in conformance with the lines and grades shown on the Drawings and to the limits depicted in the Standard Details. Before placing any bedding material, the bottom of the trench shall be hand raked ahead of the pipe laying operation to remove stones and lumps which will interfere with smooth and complete bedding of the pipe. The specified bedding material shall then be placed in layer(s) the full width of the trench, each layer not exceeding eight inches in thickness loose measure, and compacted to 95% of maximum density as determined by AASHTO T 180 D, until the elevation of the plan grade for the pipe invert is attained. The pipe bed shall then be fine-graded by hand and compacted as above. Bell holes shall be hand dug at the location of joints and shall be of sufficient size to allow proper making of the joint and to prevent the collar or bell of the pipe from bearing on the bottom of the trench.
- After the pipe has been laid and approved for covering, the specified bedding material shall be placed evenly on both sides of the pipe for the full width of the trench. Approval for covering does not imply final acceptance of the pipe, or relieve the Contractor in any way of responsibility to complete the Project in conformance with the Drawings and Specifications. Bedding material shall be placed in layers. The thickness, loose measure, or the first layer shall be either one-half the outside diameter of the pipe plus two inches or eight inches, whichever is least. This layer shall be compacted as specified above to provide solid support to the underside of the pipe.
- The bedding material shall be placed and compacted in layers not more than eight inches in thickness, loose measure, up to a plane 12 inches above the top of the pipe.
- The initial density test at any location will be paid for by the Owner. If the initial test shows that the material compaction is not as specified, the Contractor shall modify the compaction methods used, as approved by the Engineer, and have the material retested until the tests show that the compaction method meets with the Specification requirements. If the Contractor's compaction methods are not consistent and/or do not meet the requirements of these Specifications, the Owner reserves the right to undertake additional compaction tests as necessary to determine the extent of substandard compaction, and to charge the Contractor for all such tests.

3. Backfill

- The trench shall be backfilled above the bedding material, as shown in the Standard Details, with approved material saved from trench excavation. If there is not sufficient approved material from the excavation, the backfilling of the trench shall be completed utilizing imported backfill. The backfill and/or imported backfill shall be compacted to 95% of optimum density within the street and sidewalk limits, as shown on the Drawings, and 90% elsewhere, as determined by AASHTO T 180 D. Lifts shall not exceed 12 inches in depth for loose material. After backfilling of the trench is completed, any excess material from trench excavation shall be hauled to a Contractor furnished disposal site off of the Project.
- Where trenches cross roadways, streets or driveways, airport aprons, taxi lanes, etc., backfilling shall be done immediately following excavation and laying of the pipe. All crossings shall be backfilled, compacted, and open to traffic at the end of each working period. Major road crossings shall be excavated and backfilled in half widths of the traveled way so that at least one-half of the roadway is open to controlled traffic at all times during the Work. All Work performed within a right-of-way shall be done in conformance with the appropriate permits issued by the respective agency having jurisdiction over the right-of-way.
- At least 24 hours prior to commencing backfilling operations, the Contractor shall notify the Engineer of the proposed method of compaction. No method will be approved until the Contractor has demonstrated, under actual field conditions, that such method will produce the degree of compaction required.
- The initial density test at any location will be paid for by the Owner. If the initial test shows that the material compaction is not as specified, the Contractor shall modify the compaction methods used, as approved by the Engineer, and have the material retested until the tests show that the compaction meets the Specification requirements. If the Contractor's compaction methods are not consistent and/or do not meet the requirements of these Specifications, the Owner reserves the right to undertake additional compaction tests as necessary to determine the extent of substandard compaction, and to charge the Contractor for all such tests.

4. Aggregate Base

Aggregate base shall be placed in layers not exceeding six inches compacted depth, extending the full width of the trench and compacted to 95% of maximum density as determined by AASHTO T 180 D. The thickness of the top layer shall be such that, after compaction, the surface shall be at the elevation shown in the Drawings or Standard Details. Care shall be taken to assure proper compaction near the sides of the trench, and to avoid segregation.

5. Asphalt Concrete Pavement

- Pavement to be removed shall be neatly saw cut full depth along straight lines. Only such pavement shall be removed as is necessary to excavate for the appurtenances, but the pavement shall be cut a sufficient distance outside the excavation to prevent damage to adjacent pavement by lifting or tearing the mat. All removed pavement shall be disposed of at the asphalt disposal stockpile in the CBJ/State Lemon Creek Gravel Pit.
- After trench backfilling is complete, the edges of existing pavement shall be neatly saw cut vertically as shown in the Standard Details. All loose, cracked or undermined sections of existing pavement shall be removed. A tack coat shall be placed on the existing pavement edge just prior to placing new pavement.

- Pavement shall be replaced in accordance with Section 02801 - Asphalt Concrete Pavement, and as shown on the Drawings and Standard Details. Pavement shall be placed in all streets and highways as soon as possible after completion of backfilling. All trenched highway crossings shall be patched within five days from the date each trench is first opened, unless otherwise shown in the Contract Documents, or approved by the Engineer. When weather conditions, unavailability of material, or time preclude placing permanent pavement within five days, temporary pavement shall be installed. Temporary paving will consist of at least a two-inch-thick layer of a pre-mixed, asphaltic surfacing material, and shall be installed and maintained flush with the existing surface until the permanent pavement is in place. Temporary pavement shall be removed prior to placing permanent pavement.
- There shall be zero grade change perpendicular to the trench.
- Permanently seal any cracks at joints with hot bitumen after the permanent asphalt is in place. The Contractor shall repair all failed seals at joints during the 12 months after the date of final payment.

3.2.8.4 Measurement & Payment

Excavation shall be measured in cubic feet and paid accordingly.

3.2.9 Measurements

Excavation shall be done as per authorized outlines mentioned in heading 3.1.3 of these specifications. The exact quantum of earthwork shall be ascertained by taking measurements of excavation from which the material has been taken out and not of the resultant spoil and converted to solid measurement by multiplying it with factors mentioned below for soil and rocks. The unit of measurement shall be cubic feet.

The following table shows the factor to be used multiplying in-situ measure for converting into solid measure: -

In – Situ Measure	Multiplication factor for		Remarks
	Soils	Rocks	
Loose Measure	0.80	0.60	These figures are accurate or otherwise shall bind all parties
Packed Measure	0.89	0.67	
Solid Measure	1.00	1.00	
95 – 100% modified AASHTO	1.10	Nil	

Table 4, Measurement Factors (Chapter-3)

1. Solid Measures: Materials in their natural state before excavation etc.
2. Packed Measures: Materials which have been spread, leveled and / or filled, watered and rammed or equally consolidated (e.g. heaps, etc. consolidated by exposure to weather, etc. for a period exceeding six months).
3. Loose Measures: As packed measure but not rammed or equally consolidated (e.g. heaps etc. consolidated by exposure to weather etc. for a period of not exceeding six months).

3.2.9 Payments

The payment shall be full compensation for all costs to comply the provision of above specifications. A special rate shall be settled and paid for the following items of works:

1. For cutting down, removing and digging out roots of all trees (not shrubs, grass etc) of 2 feet girth. Measurement of girth shall be taken 5 feet above ground level. Rate shall be fixed for each tree. Trees shall be counted and marked before removal. This work may be done departmentally if thought necessary by the engineer-in-charge.
2. Special material such as sand, or selected earth, brought from the other source than retrieved from the excavation.

3.3 Embankments

3.3.1 General Description

An embankment is constructed for any of the following purposes: -

1. Storage of water as in case of dams etc.
2. Flood protections to check erosion and spill, etc.
3. River training on the head-works.
4. Keeping the water in the running channels in the fillings i.e. reaches where the water level in the channels is higher than the ground level.
5. Maintaining uniform slope of rail track and road formation (metaled or un-metaled) in filling i.e. reaches where the proposed formation level is higher than the natural surface level.
6. Bridging depressions or attaining uniform slopes of the link between two or more embankments.
7. Depositing the material obtained from precise or borrow-pit excavations considered unsuitable for any use or rendered surplus.

Embankments can be divided into three main categories depending upon their object. These are: -

1. Water retaining embankment.
2. Rail and road embankment.
3. Spoil bank.

1. Water Retaining Embankment

It is constructed with selected material on account of its following peculiarities

1. It has to be watertight as much as possible to resist percolation.
2. It shall be strong enough to withstand the hydrostatic pressure.
3. It shall be impregnated to guard against erosion and wave-wash.
4. It shall have an adequate base friction to eliminate chances of sliding.
5. It shall settle evenly on alternate wetting and drying without cracks or cavities.

Relative Merits or Various Soil Available in Pakistan For Construction of Water Retaining Embankments

1. **Sand:** It usually comprises 75 to 80 % of sand, about 10 to 15 % of silt and 5 to 10 % of clay. It has following merits and demerits.

Merits:

- a) It shrinks little and hence need little settlement allowance.
- b) It is an ideal material for hearting or core of an embankment since it does not permit leakage.

Demerits:

- a) It allows a considerable amount of seepage.
- b) It is readily worn away by wave-wash because it has poor cohesion.
- c) It has a very flat saturation gradient and thus requires a large section and very flat slopes on water side.

d) It has a very flat angle of repose under water.

The sand embankments are, therefore, covered with at least one foot of pucca clay soil on top and 6 inches on the slopes to retain the section.

2. **Clay:** It contains about 50 to 60 % of clay 35 to 40 % of silt and 5% of fine sand. This sort of soil is most unreliable and not very suitable for the main body of embankments, because it expands on wetting and shrinks unevenly in drying which give rise to cracks and cavities. These cracks and cavities make the embankment porous and cause numerous leaks. It shall be employed only where it is unavoidable; but in this case the embankment shall be trenched for wetting purpose and provided with sand core. Hard clay is, invariably, have a cover of the hardest clay available, particularly on their upstream slopes.
3. **Sandy Clays:** This soil ranges between sand and clay and has approximately the following constituents; sand 50 to 70 % clay 30 to 50 % and slit upto 20 %. Embankments constructed with this material, particularly if they have the optimum admixture of clay and sand, and have been thoroughly compacted, are very satisfactory and can be relied upon. They are resistant to wave-wash, and it is very rare that leaking occurs.
4. **Loam:** It comprises 30 to 50 % of sand, 30 to 50 % of silt and less Than 20% of clay. Its particles are fine and packed well. It has, however, little stability when saturated. Embankments of loam require a facing of clay, and are resistant to leaks only when hearting is of sandy loam.
5. **Kalar:** It is absolutely unsuitable for raising embankments since it decomposes under the action of water and given rise to leaks. It is very treacherous and shall be avoided as far as possible.
6. **Numbs and Organic Soils:** They are very bad for making embankments and shall be carefully avoided.
7. **Stabilized Soil:** If the existing soil does not possess the requisite qualities, stabilized soil for embankment can be obtained by blending the following proportions of material:

a) Sand (0.02 to 2.0 mm....	60 to 80% by weight
b) Silt (0.002 to 0.02 mm....	12 to 25% by weight
c) Clay (below 0.002 mm....	08 to 15% by weight

3.3.2 Construction of Embankment

The following steps are involved in the actual construction of an embankment:

1. The surface area of the ground to be occupied by the embankment is cleared of all rubbish, grass, roots, shrubs, brush, trees, fences, buildings, metaled roads, ruins and such other structures as may either cause hindrance in the execution of work or might decay and form dangerous pockets subsequently.
2. All loose surface or soft soil is removed to about 6 inches depth and the surface roughened by ploughing or digging all over. Small key-trenches are sometimes dug out in the bad to unite the body of the new embankment with the sub-soil. Another way of preparing the soil is by cutting v-shaped benching, at intervals, running parallel to the central line. A key trench is very essential where the ground is porous, sandy or cracked. All soft soil is removed as far as possible, specially soils containing salt.

3. The central line of the embankment is distinctly marked with a dagbel, and pegs are fixed at every chain. The toes of the embankment are clearly lock-spitted and all curves in the alignment properly laid and half breadths carefully set out.
4. A complete profile of the embankments is set up at an interval of 500 feet and at every change of section as well as at every curve. This profile is 10 feet long of the actual completed embankment, with its correct heights, widths and all slopes dressed to true form. The correct height of this profile is 5 to 10% greater than the final level of the embankment depending upon whether the embankment is to be compacted up to 95% dry density or it has to guard against shrinkage and settlement. The ends of this profile bank are stepped so that proper locking takes place while constructing the banks adjoining them. Batter boards are employed for checking the slopes of the embankment.
5. The embankment is completed according to the approved profile by spreading earth in uniform horizontal layers of 6 inches to one-foot thickness for the entire width. Each layer is thoroughly compacted before the next one above it is laid.
6. The top of the bank and slopes are carefully dressed and no hollows or humps are allowed to remain.
7. Proper ramps and turning platform are provided for road crossing etc. in the case of ramps a gradient of 1 in 15 with an inner slope of 15 feet radius from the embankment on to the ramps usually works well.

3.3.2.1 Dressing

The embankment shall be dressed neatly as per designed section and grade, after it has been completed and thoroughly consolidated. The top and slopes shall be protected from any damage and maintained, till the work is completed and handed over to the Engineer-in-Charge.

3.3.3 Compaction of Embankment

The Compaction of the embankment may be required at specified relative density according to ASTM D 1556 at optimum moisture content or otherwise compaction as required. The object of compacting soil is to improve their properties in respect of strength, liability to settlement and resistance to weathering. It involves the following processes: -

1. The earth is placed in the embankment in uniform layers of 6 inches to one-foot thickness depending in the hardness of the soil and the weight of rollers used for consolidation, stretching right across the whole section. An embankment is never, originally, made of less than full width so that it could be widened subsequently.
2. It is desirable to take earth first from the more distant pits, gradually lessening lead as the embankment rises, so that all earth is thrown into the slope and not tipped over.
3. All large clods are broken up in the borrow-pit, and no clod larger than man's fist is brought to the bank.
4. The width of each layer is usually a little more than the width required by the cross-section of the bank. The slopes are then dressed off to final section and not filled in afterwards.
5. Each layer is compacted by rolling or ramming before laying the next one above it.
6. On important embankment each layer is brought to the optimum moisture contents and rolled to produce the maximum density.
7. Longitudinal bunds above 6 to 9 inches high and one foot wide on the top with side slopes of 2 to 1 may be made on the outer edges of the top of embankment. Also, cross bunds of the same dimension at every 25 feet to 50 feet are provided so as impound rain water to expedite consolidation before the monsoon sets in.

3.3.3.1 Compaction of Embankment (Under Optimum Moisture Conditions)

The optimum moisture contents for specified density shall be determined by contractor in laboratory in advance of start of construction. Control on compaction in the field shall be exercised through frequent moisture content and density determinations. A systematic record of these shall be maintained. At all times during construction the top of the embankment shall be maintained in a profile to shed water and prevent pounding.

3.3.3.1.1 Control Tests on Borrow Material

Soil suitable for consolidation under O.M.C. conditions should preferably have the following characteristics:

a)	Minimum percentage of clay	10%
b)	Liquid limit	14%
c)	Plasticity index (ASTM D-4318)	4%
d)	Percentage of silt should not exceed	5%
e)	Peat, muck and organic soils are unsuitable	Nil

Table 5, Characteristics of soil for consolidation (Chapter 3)

The Engineer-in-Charge may, however, relax these requirements taking into account availability of materials, cost of transportation and other relevant factors. Various test required to be conducted on the borrow material with their recommended frequency are indicated below. All the test need not be stipulated on every project. Depending upon site condition etc. only some may be found necessary at a particular project. The frequency of testing indicated refers generally to the minimum number of tests to be conducted. The rate of testing must be stepped up as found necessary depending upon the variability of the materials and compaction methods employed at a project.

1. Gradation:

At least one test for each kind of soil. Usual rate of testing shall be 1 to 2 tests per 8000 cum of soil.

2. Plasticity:

At least one test for each kind of soil. Usual rate of testing shall be 1 to 2 tests per 8000 cum of soil.

3. Proctor Tests:

At the rate of 1 to 2 tests per 8000 cum of soil.

4. Deleterious Contents:

As required.

5. Moisture contents:

One test for every 250 Cu. M. of soil.

3.3.3.2 Rolling

The following are the suitable rollers for rolling purposes.

1. Sheep foot rollers are suitable for compacting dry. Cohesive soils at low moisture contents.
2. Pneumatic tyre rollers are most suitable machines for compacting soils in embankments.
3. Smooth-Wheeled rollers are satisfactory in most cases of sub-grade and base compaction.
4. Vibrating machines are suitably employed for compacting granular soils in confined areas like foundation and abutments.

5. Rammers are employed for compacting clay soils in confined areas like foundations and abutments or where none of the types mentioned above could be available.

The organization of filling, spreading and rolling shall be done in such a way that newly-deposited fill is spread and rolled smooth immediately in order to minimize the loss of moisture. To prevent the material from sticking to the rollers, dry earth is sprinkled, if necessary, on the surface before or during consolidation. Watering is not done till the layer has been completely rolled. Flooding with water to effect compaction of the fill is a bad practice. Water is, however, sprinkled over the rammed layer before the next one is spread to let the two layers adhere. No matter how well an embankment has been consolidated it keeps on setting for some years owing to its own weight and weathering actions. The total vertical settlement of a well-consolidated embankment is about 1/30 of its height.

3.3.4 Precautionary Measures

To safeguard against the failures of earthen embankment owing to percolation, piping, heaving, slipping, leakage, erosion, etc. the following precautions are observed: -

1. **Increase Width of Slopes:** The width may be suitably increased in order to provide additional strength. In the case of embankment over 15 feet high and composed of materials containing high percentage of clay, the side slopes may be increased up to 4 to 1, depending upon the height of the embankments, next slope to which the material will stand without severe sloughing. Alternatively, the berms may be provided 7½ feet wide for every 15 feet height of such embankments.
2. **Cut-Off Trench:** In order to render the foundation of an earthen dam impervious to seepage water, a cut-off trench is made in the bed under the dam up to the depth that will prevent water from percolating underneath it. The trench is made in the center of the dam, over which the core wall is built. Holes may be drilled all along the bed of the trench and thoroughly grouted with cement so as to provide a deep curtain below the bed, which is impervious to water. The trench is filled with puddled clay or concrete which is well bonded into the bottom of the trench by keys or grooves to ensure water tightness. Puddling in the trench is carried out by heeling by feet by workmen. The usual depth of a cut-off trench is 20 to 30 feet (it is not uncommon to have the trench 100 feet below the surface and still deeper walls have been built) and width 6 to 10 feet depending upon the depth.
3. **Key Trench:** A trench under river banks which has the same functions as a cut-off trench and increase the path of percolation of the water. A key trench is very essential where the ground is porous, sandy or fissured. Usual section is: depth 3 to 5 feet, bottom width 4 to 6 feet, side slopes ½ to 1 to 1. Where the cut-off trench is filled with concrete and puddle core wall built over it, suitable grooves shall be made for the core wall to key into the concrete below. Strata which are not wholly watertight can be made impervious by injecting cement grout. The process consists of drilling small holes (2 to 5 inches diameter) into the strata and forcing in, under pressure, liquid cement either with or without sand or other fine aggregate. The cement enters and sets in the cracks and fissures in the soil, thus sealing them against the passage of water. If the trench is filled with concrete before grouting, it will provide an adequate weight to prevent undue waste of cement. Pipes are brought up through the concrete for grouting. It is interesting to note that sodium silicate has been used to seal strata into which it would have been difficult to inject cement grout. Under certain conditions of the soil it is obligatory to use cement concrete or grouting.

4. **Sand Core:** A sand core is sometimes provided where the embankment has to be built on an unreliable kalarish soil. It is keyed 3 feet into the ground and carried up to the high flood level line. Giving 4 to 6 feet width at the top with side slopes the sand will naturally stand. The core wall is usually provided in the centre of the bank, but if it is to be extended later on, it may be provided on the upstream slope with sufficient cover of earth over it. If any holes or cavities are formed by borrowing animals or ants, the sand will collapse and fill the holes, and thus breaches are avoided.
5. **Core Walls:** The object of a core wall is to provide a barrier to the passage of seepage water from the water side to the rear of the dam and also to the passage of borrowing animals that cause dangerous breaches in embankments. A core wall may be of compact clay puddle, masonry (also called a diaphragm wall), concrete, or planks driven as sheets piling for small or temporary dams, taken down to impervious strata. The core wall may be located either in the centre of the embankment or on the water side of the slope.

Both the methods have their own merits and demerits depending upon the material and other conditions. Although the outer core wall prevents percolation of water into the dam, it is liable to cracking owing to alternate wetting and drying as a result of fluctuation in the water level. It is also liable to injury owing to settlement of the slope. The puddle core wall is generally 4 to 8 feet wide at the top. Both sides batter outwards about 1 in 12 or 1 in 10 to the ground level below which the thickness is quickly reduced to about 2 feet wider than the top width and carried down in this way as far as necessary. The thickness is increased if the puddle clay is of poor quality. The top of the core wall is kept 1 foot above the high flood level and 2 to 3 feet below the top of the embankment. It is always preferable to make the whole embankment of one homogeneous watertight material and do away with the core wall which is liable to produce cracks and other defects in the body of the dam owing to unequal settlements of non-homogeneous materials. Earth for the dam near the puddle needs to be specially selected and well consolidated to minimize unequal settlement of the earth and the puddle core. The dry soil around the puddle wall shall be carried up simultaneously with the earthwork of the bank. At ground level a suitable groove or ordinary earth is placed over the top of the puddle core is keyed. A covering of 3 to 4 feet of ordinary earth is placed over the top of the puddle core to prevent shrinkage and swelling caused by exposure to atmospheric changes. Where the height of dam exceeds 60 feet, a masonry core wall is preferred to a clay wall. It is compact clay core which gives real strength and impermeability to dams.

6. **Clay Puddle:** Pure clay does not make a good puddle although it may be sufficiently impermeable to water, since it is liable to crack. An admixture of about $\frac{1}{2}$ to 1 part of sand with 2 parts of clay (exact proportion depends upon the nature of clay) will reduce shrinkage considerably. Clay containing sodium carbonate is considered to be the best and most suitable for making roofing tiles. If sand is not easily available moorum shall be tried, but the mixture must be free from stones. Where black cotton soil is found it shall be mixed with moorum in the proportion of not less than 1 to 1, preferably 2 to 1. Puddle core of such material shall be thoroughly tested before attempting any important construction. The clay shall be dug up and left exposed to air in layers not more than 12 inches thick for at least 2 to 3 days and watered a few times a day. The materials for making puddle shall preferably be passed between a pair of rollers placed not more than half an inch apart so that stones and gravels, if any, are crushed before water is added. The scoured clay shall be passed through a pug mill or thoroughly worked up by men's feet into a smooth homogeneous plastic mass, while just sufficient water is added. A puddle has a proper consistency when it can be squeezed in the hand and on release of pressure appreciable quantity does not adhere to the hand. A piece of clay puddle when dried shall not shrink more than an inch and a half

(preferably one inch) and not less Than three quarters of an inch per liner foot; otherwise it will probably not be sufficiently impermeable to water. The clay puddle shall be consolidated compact and deposited in layer not exceeding 6 inches in thickness. Each layer shall be thoroughly moistened before the new layer is laid and must be completely incorporated with the layer below by making cut, or keys. Special precautions shall be taken to prevent the puddle from becoming dry; otherwise it will crack. The puddle that has become dry or has cracked must be replaced. There shall not be any right angles in the cross-section of the puddle wall or trench, since they might produce fissures or cracks in the puddle. In building a clay core, the clay shall be contained within boards which can be raised as the dam is build up. Ideally, each layer of puddle shall be contained over the whole length of the core wall before another layer is placed, but in practice this is not always possible.

7. **Pitching:** Pitching is covering if a hard material such as, stones kankar, blocks, concrete block or bricks, laid over slopes of an earthen embankment. If possible, one rainy season shall be allowed to elapse and the bank given time to settle after it has been built, before pitching or any kind of stonework is undertaken. Slopes of embankments shall not be steeper than 1:1, although 1½:1 shall preferably be adopted. Rough stones are generally used for pitching with a thickness varying from 9 to 24 inches according to the velocity or wave action of the water. Stone shall preferably be packed and firmly embedded over a bedding or backing of 3 to 9 inches thick layer of small broken stones, quarry rubbish, moorum, gravel, ballast or small kankar, thoroughly consolidated over the earthen slope to prevent the earth from being sucked out from between the stones by wave action.

Pitching shall be constructed at right angles to the slope to be safe against sliding. The pitching stones shall be the heaviest available that can be handled, and roughly cut to fill in properly. Stones shall be tightly packed by hand and laid with their broadest face downwards, with as large a proportion of through stones as possible, giving due regard to bond. All interstices, hollows and inequalities between stones shall be filled up with smaller pieces and wedged up tight with spawls driven in with slight hammering. The outer face of the pitching shall be made as smooth as possible so as not to set up eddies that may cause scour lower down. The toe of the pitching shall generally be carried 2 or 3 feet below the foot of the slope (into the ground) or a small retaining wall built. This shall be done to give the toe a footing below saturated and soft-top soil of the bed, for the stability of the pitching and security of the slope against slipping. Pitching shall be widened out at the toe (near and below ground) so as to distribute the pressure over a wider area. If the bank is soft and credible, the foot of the slope may be secured by piling (instead of a small retaining wall suggested above) and the thickness of the stone pitching downwards may also be increased at the rate of one inch per foot. The top more course shall be horizontal and laid in one level line throughout the length of the embankment, preferably in mortar, and rounded off at the corners in side pitching. Pitching shall be at least 3 feet higher than the high flood level and, if possible, shall not be carried up to a greater height than 10 feet, without giving a berm somewhere. In case concrete or kankar blocks or used they shall not be less Than one cubic foot in size. If brick pitching is used, only one brick shall be placed for each course either as a header or stretcher to prevent sliding. In reinforced brickwork pitching, care shall be taken to leave expansion joints vertically at suitable intervals; the bricks are laid with frog downwards. In case stone pitching is to be pointed or grouted, the voids shall be filled up with small chips or gravel and then pointed, or concrete grouting poured in.

8. **Revetment:** It is facing of dry-stone pitching or other material laid on a sloping face of earth to maintain the slope in position or to protect it from erosion, and is generally

constructed with a slope of 1 ½ to 2 ½ feet according to the height. Other details given under “Pitching” shall be followed. If stones are not procurable, mattress formed from brushwood may be used, which are bundles of branches and twigs from 8 to 12 inches in diameter and about 12 feet long and are bound with tarred ropes at intervals of 4 feet, laid side by side and tied together. These brushwood bundles shall be secured by stakes or short piles to the bank on which they are deposited.

9. **Plantation and Turfing:** When banks dry up during the period of draught, the soil material of the banks becomes friable and cannot stand the action of water waves, if plantation is possible, pilchi, sarkanda, willow or other suitable trees shall be planted for a width of about 100 feet in front of the toe of embankment. Such plantation breaks the force of the waves. Whenever practicable, grass (turf) shall be grown on the side of the slopes. Turfing shall consist of sods not less than 4 inches thick and 9 inches square, well beaten into the bank. Before grass is grown, the slopes are properly dressed. It is kept in view that the earth placed in the slopes is suitable for the nourishment of turfing.

3.3.5 Failure of Earthen Embankment:

Failure of an earthen embankment is due to the following causes:

1. Erosion as a result of the velocity of water action of waves, rain and wind. Erosion causes slipping to combat this menace stone revetment is made or pitching is done. As explained in the following pages.
2. Over topping because of insufficient height of freeboard. This cause is responsible for most of the failures.
3. Percolation and leakage on account of insufficient ramming of the embankment and porosity of the material. The leakage water washes away the soil and caves are formed in the bund. Percolation may occur under the foundation or through the bund proper.
4. Slipping owing to steeper slopes than the material can stand. Slipping occurs on account of the over-saturation of the downstream side of the bund which has insufficient cover. The bund must stay within the “line of saturation” as explained earlier. Proper drainage shall be provided by putting in granular material on the land side toe to drain out the surplus water. When a slip has occurred, all the slipped portion and the loose and slushy stuff must be removed and replaced by fresh dry material. The site of the slipped portion shall be stepped back or benched and fresh soil added layer by layer, properly rammed and brought to the proper slope.
5. Leakage on account of cavities or holes formed by the borrowing animals, insects and rats. Hollows are also formed by the roots of trees which have decayed, leaking outlets pipes or conduits. Efficient patrolling of the banks shall detect these before they develop into benches. Slopes and tops of embankment shall be provided with a layer of hard material which the borrowing material cannot penetrate. If a sand core provided the sand collapses and fills the rat or ant holes and the leakage stops. Breaches also occur because of intentional cuts by cultivators.
6. Excess supply raises the hydraulic grade line, wetting the portion of the bank which was never wet before. It settles down the dry earth of the bank above and causes a breach.
7. General defective construction and maintenance can, of course, always be a cause for failure.

Closing Leakage: If the water flowing through a leak is sluggish and clear, it may be seepage water and there is no immediate danger. If, however, it is muddy and fast moving and carries the soil particles of the bank, the leak needs immediate attention. Correct location of the hole both sides of the bank is essential which may not always be perpendicular to the bank. If the hole is of big size there is a whirling action in the water just above the hole. If it is small, heavy turf sods are thrown on the surface of water near its approximate location. They are soon attracted towards the leak and may come out at the rear. Leakage can be closed by throwing sawdust, bran, powdered, dung, etc. just upstream of the leaks. The stuff is carried by water into the leak where it swells and stops the leaks. Holes can also be plugged from the front side with balls of clay and turf which can be pushed into the holes. A method for closing big leaks is to cut an inverted T-shaped trench a little above the water line outside the bank, the entire leak is then opened out starting from the exit side, and all is filled with best material available (loam is ideal for the purpose), softened with water. The trench side shall be made in steps for good bonding.

Closing of Breaches: Before starting to close a breach, labour and material (such as earth, sand, gunny, bags, stakes, brushwood) shall be collected at side in sufficient quantity. If earth is not available it can be obtained by cutting the outer slopes of the existing bank. Enough earth shall be collected in both sides of the breach on the existing bank. The ends of the banks shall be protected first to prevent further widening. The process starts from both ends by slipping the earth from the heap and protecting channel sides by grassy clods usually available from the berms. Earth baskets shall never be thrown in the water. A semi-circular bund (ring bund) may be constructed on the water sides with stakes, brushwood, mats, earth, etc. and water bailed out. The sides and bottom of the existing bund at the breach site shall be cut into steps to remove all loose material and to form good bond with the new material. In case good soil is not available, a core wall shall be provided.

1. **Closing Breaches in Big Canals:** This is usually done by driving a double line of stakes and filling jungle in between the stakes, pressing it down with bags filled with sand and by men walking over them. A temporary bank of gunny bags is thus raised in the position of stakes and busing. Straight closure in large channels is not possible. No earthwork shall progress before the flood through the breach has been arrested to some extent in this way. The closing of the breach is done by constructing a ring bund behind the line of stakes. Earth is slipped from both sides a form the ring bund.

3.3.6 Embankments Specification

1. Embankment shall be constructed according to the approved profiles. Earth shall be taken from an approved source, borrow-pits or spoils, and shall be free from roots, grass, shrubs or other organic matter liable to decay.
2. Embankment shall be built in horizontal layers, approximately 6 inches thick. These layers shall extend to the full width to the required side slopes and shall not be widened with loose material dumped from the top.
3. All clods and lumps of earth shall be broken up in the borrow-pits to a diameter of not more than 2 inches. Any clods or lumps thrown on to the bank shall be broken up and spread before compaction begins.
4. The top of bank and the slopes shall be carefully dressed according to the approved profiles. No hollows or humps shall be allowed in the slope.
5. Approaches to the roads and railway crossings will be made to a specified gradient, and crossing shall be so constructed that the roadway between the gates of level crossings is level for all classes of level crossings. The level portion will further extend outside the gates to such distances as are shown below:

- a. Special class level crossing: Roadway shall be level up to 35 feet outside the gate followed by the gradient not steeper than 1 to 40.
- b. "A" class level crossing: Roadway shall be level up to 24 feet outside the gate followed by the gradient not steeper than 1 to 30.
- c. "B" class level crossing: Roadway shall be level up to 15 feet outside the gate followed by the gradient not steeper than 1 to 30.
- d. "C" class level crossing: Roadway shall be level up to 10 feet outside the gate followed by the gradient not steeper than 1 to 20.

The angle of intersection between the central line of roads and railways shall not be less than 45°.

3.3.6.1 Backfill and Compaction of Embankments (around Structure etc.)

Embankments and backfill designated as compacted shall be compacted to the lines, grades and slopes shown on the drawings or as directed by the Engineer-in-charge in writing.

1. The contractor's operations in the excavation of material designated for use in compacted embankment or compacted backfills, shall be carried in a way that results in an acceptable gradation of the materials, when placed. The compacted embankment shall be constructed of the finest and most suitable material for impermeability and stability.
2. The material in each layer before and during the time is being placed shall have the optimum moisture content of 2% throughout, required for the purpose of compaction as determined by the Engineer-in-charge. The material shall be brought to the proper moisture content at the site of excavation in so far as it is practicable, but such moisture shall be supplemented by sprinkling water at the site of compaction. If the moisture content is greater than the optimum, the compaction work shall be delayed till the material has dried to the optimum moisture content.
3. The material to be compacted shall be deposited in horizontal layers, 6 inches thick as compacted. Its distribution shall be so as to ensure that the compacted material is homogenous and free from pockets, lenses, streaks or other imperfections.
4. When the material has to be conditioned and placed as specified it shall be compacted by ramming or by suitable equipment of proper weight and size duly approved for use by the Engineer-in-charge.
5. For those portions of embankments of backfill which are adjacent to structures, including concrete pipes, where it is not possible to obtain adequate compaction with rolling equipment, the embankment or backfill shall be compacted with mechanical tampers or rammers of proper weight and size so as to obtain the same degree of compaction as the adjacent compacted embankment or backfill. The contractor shall be responsible for any damage to the structure caused by his operation in placing or compacting embankment or backfill material. Adjoining structure and all damage shall be repaired at his expense. In placing and compacting backfill or embankment adjoining concrete pipe, sufficient material shall be carefully placed on both sides of the pipe and tamped about the pipe so that the pipe is held firmly to the established line and grade. The material shall then be placed and compacted in layers as here in specified equally on both sides of the pipes to prevent displacement of the pipes during the placement and compaction of the adjoining material.
6. The material in compacted embankments and compacted backfill shall be compacted till the density of the compacted material is not less than 95% of the maximum dry

density as determined by suitable laboratory tests. The contractors shall afford all possible help to the Engineer-in-charge in obtaining representative samples for testing. Incidental cost of this operation shall be borne by the contractor as the rate for compaction is inclusive of it.

7. If any of the work is being insufficiently consolidated earthwork shall be stopped till the consolidation is due to the satisfaction of the Engineer-in-charge. If the contractor fails to carry out specified compaction, the Engineer-in-charge may either add labor at the contractor's expense or take over the whole or part of consolidation and do it departmentally. In such cases the expenditure incurred departmentally shall be deducted from the contractor's bill.
8. Whenever soil survey on the distribution of soil and groundwater conditions indicates the need for the stabilization of the bed of cuttings, the side slope and fills, by artificial means, i.e. injection under pressure of cement, sand, slurries or bitumen, it shall be carried out under the direction of the Engineer-in-charge. If the fill material requires stabilizations, it shall be carried out according to the direction of the Engineer-in-charge.

3.3.6.2 Key Trench and Sand Core

1. The key trench shall be excavated true due to alignment and section specified. Its bed shall be taken correct to the level shown on the approved drawings or as directed by the Engineer-in-charge and extra excavation shall be filled in with pure sand of the same quality as in the core. The extra filling shall be done by contractor at his own expense, if he is responsible for this extra excavation.
2. Shoring and strutting necessary for the excavation of the trench to the specified dimensions shall be provided as per Specification No. 17.1(A) 10 by the contractor at his own expense.
3. In the event of slips during excavation, the trench or the front slope of the main embankment shall be remade to the correct slopes and bed levels and all loose and friable material removed from the bed by the contractor before filling is commenced. No claim for remarking the slopes, remaining the loose and friable material or extra filling the side or slope or bed shall be entertained.
4. The excavated staff shall be temporarily stacked in stock piles and finally deposited as directed by the Engineer-in-charge.
5. No portion of the trench, however small, shall be filled in, unless approved by the Engineer-in-charge.
6. The key trench shall be measured and all dead men or other distinctive marks removed. Such removal shall be inspected by the Engineer-in-charge or his authorized subordinate before filling is commenced.
7. The sand to be filled in the core shall be obtained from an approved source. The sand shall also be approved on the site of sand coring by Engineer-in-charge or his authorized subordinate before filling is commenced. In the event of unauthorized filling prior to the approval of the bed of the trench, the contractor shall forthwith remove the filling to the correct bed level at his own expense when so directed by the Engineer-in-charge.
8. Sand shall be filled in 6-inch layers upto specified depth and properly compacted. Filling beyond sand core depth with earth shall not be commenced before the top levels have been checked and approved by the Engineer-in-charge or his authorized subordinate.

9. If the bank is to have a sand core, the sand filling, unless otherwise specified or directed by the Engineer-in-charge, shall be laid side by side with the layers of the embankments up to the height specified.
10. Where sectional measurements of the embankments are proposed to be taken, no deduction shall ordinarily be made for bulkage of the sand in the sand core and the usual factors of these specifications shall be applied.
11. The measurement and payment of sand utilized in the sand core shall be made according to the specification.

3.3.6.3 Puddle Core

1. The puddle shall be constructed when shown on the drawing or directed in writing by the Engineer-in-charge.
2. The clay for the puddle core shall be obtained from an approved source.
3. The clay suitable for backfilling shall be generally acceptable. Preference will be given to one containing sodium carbonate.
4. Unless otherwise specified or directed in writing by Engineer-in-charge, a mixture of about half to one part of sand with two parts of clay shall be used.
5. Where sand is not easily available moorum (free from stone) and black cotton soil in equal portion shall be used.
6. Before actual construction begins the mixture shall be thoroughly tested.
7. Clay shall be dug up and left exposed to the air in layers, not more than 12 inches thick, for at least two or three days and watered a few times every day.
8. Before mixing water, the materials for making puddle shall be passed through a pair of rollers placed not more than 1/8 inch apart or screened through a mesh of 1/8 inch so as to eliminate stone or gravels, if any. Thereafter it shall be passed through a pugmill or otherwise well worked up by men's feet into a smooth homogenous plastic mass. Only sufficient water shall be added while this is being done. The correct consistency for good puddle shall be that at which it can be squeezed in hand without any appreciable quantity sticking to the hands pressure is released.
9. The bottom layers in puddle trenches shall be made of puddle tempered upon the surface and thrown or dashed into the trench in balls to fill inequalities.
10. Clay shall be deposited in layers not exceeding 6 inches in thickness and each layer shall be thoroughly moistened, compacted and incorporated with the layer below by making "cuts" or "keys".
11. If too much water has to be used, the layer shall be excavated and removed from the trench before another one is laid upon it.
12. The construction of the puddle wall or clay puddle shall be carried up simultaneously with earthwork of the bank.
13. At ground level a suitable groove or nose shall be constructed to key down the puddle core.
14. Special precautions shall be taken to prevent the puddle becoming dry; otherwise it shall crack. All puddle which have become dry or have cracks on account of contractor's ignorance, shall be replaced at his expense.
15. In building a clay core, the clay shall be contained within boards which can be raised as the embankment is built up.
16. There shall not be any right angle in the cross-section of the puddle core.
17. A covering of 3 to 4 feet of ordinary earth shall be placed over the top of the clay puddle to prevent shrinkage and swelling owing to exposure to atmospheric changes.
18. Measurement of the clay puddle shall be made by volume. The unit of measurement shall be 100 cubic feet.

19. The unit rate shall include supply of clay of an approved quality, working it up into puddle, laying, ramming, etc., as per above specifications.

3.3.6.4 Borrow-Pits

1. All earth for embankment and backfills shall only be obtained from borrow-pits set out (demarcated) by the Engineer-in-charge. The borrow-pits shall be located opposite to or as near as possible to the site of the fill.
2. When directed to do so, the contractor shall take earth from old bunds, mounds, key trenches, old borrow-pits, etc., only after they have been measured and measurement has been recorded by the competent authority. No such authorization shall be made unless the measurements mentioned above have been duly recorded.
3. The earth taken from any place, not duly authorized by the Engineer-in-charge, shall not be measured and paid for and the contractor shall be responsible for any damage arising from authorized pits.
4. No borrow-pits shall be excavated on or close to rail or road ways, village tracks, canals, level crossings or existing embankment and within 3 feet of the railway boundary. Borrow-pits shall not be located near residential and commercial areas but in case it is not avoidable their depth shall be limited and, where possible, arrangements shall be made to drain them. The sides of all such borrow-pits shall have a slope of 3:1. Any borrow-pit which does not conform to these specifications shall be properly filled in with earth obtained from approved pits and consolidated and dressed correct as specified at the contractor's expense.
5. Borrow-pits, excavated to a depth not exceeding specified depth by 10%, shall be paid for full excavated depths at the discretion of the Engineer-in-charge. However, where the actual excavated depths are more than 10% of specified depths, specified depths alone shall be paid for.
6. Borrow-pits shall preferably be multiples of 10 feet length, to facilitate recording of measurements.
7. As and when directed by the Engineer-in-charge, borrow-pits shall be ploughed by the contractor after final measurement has been duly recorded and checked by the competent authority before the final bill of the contractors is paid.
8. All borrow-pits shall have distinctive marks, as directed by the Engineer-in-charge. The location of these marks shall depict the average height of the borrow-pit. Where the material surface is regular they shall be left at equidistant intervals, and shall be allowed to remain intact till measurement have been recorded and checked. The contractors shall have to remove all such distinctive marks before he is paid finally. A certificate to this effect shall be given by the Engineer-in-charge in the final bill for payment.

3.3.7 Measurements

Please refer to the section 3.2.9 of these specifications.

3.3.8 Payments

Please refer to the section 3.2.9 of these specifications.

3.4 Earthwork for Repairs

3.4.1 Repairs to Bank (Holes and Ravines)

1. All holes (gharas) and ravines shall be, wherever possible, first fully opened out to the bottom.
2. All lumps of fallen earth shall be dug away, and the sides dug down in steps not more than 1 ½ feet deep.
3. All jungle, grass, roots, or other rubbish shall be thoroughly cleared, and the work when ready for filling shall be inspected and passed by Engineer-in-charge before filling begins.
4. Filling shall be done in accordance with the Specifications indicated for foundation pits.
5. At the ends of day's work, top layer shall be flooded with water to attain consolidation.
6. During the work in progress rammers of approved type shall be employed for ramming, as directed by the Engineer-in-charge.
7. In all other respects it shall conform to the Specifications, unless otherwise specified or directed in writing by the Engineer-in-charge.

a. Repairing of Banks by Earth from Berms

1. Where a silt berm exists, earth for filling and repairing shall be obtained, as far as possible, by cutting away such berms
2. Care shall be taken that a layer of at least 6 inches thick of silt adjacent to the bank is left intact except under special orders of the Engineers-in-charge and that cross dowels are left at close intervals in the berm so that borrow pits may silt up quickly.
3. Any bank which is to be widened or raised shall be ploughed or cut into steps.
4. Raising or driving banks shall not be done with sandy earth or silt.

b. Repairing of Banks by Earth from Spoil Banks

1. In case there is no berm, earth shall be obtained from the spoil bank if there is one or from outside excavation.
2. In getting earth from the spoil bank, borrow-pits on top shall be strictly prohibited, since in wet weather they from banks and lead to damage by breaching.
3. Earth shall preferably be obtained from the back of the spoil, or by widening the drainage gaps in the spoil's banks.

c. Repairing of Banks by Earth from Borrow-Pits

1. Where there is no spoil, earth shall be obtained by leveling down any high lumps, and last of all from borrow-pits.
2. Where borrow-pits are unavoidable, they shall be dug as far from the toe of the banks possible and shall not be more than one foot deep, unless otherwise specified.
3. Borrow-pits shall be neatly set out parallel to the banks, if there were no old borrow-pits.
4. The dimension and distinctive marks in the new borrow-pits shall be fixed by the Engineer-in-charge to avoid any mixing with the old borrow-pits.
5. All old borrow-pits shall be measured and measurement duly recorded and checked before new borrow-pits are put in.
6. A bar, at least 10 feet wide, shall be left after every chain to eliminate all chances of regular rain water drain running along the bank.

3.4.2 Silt Clearance

1. The ultimate levels after silt clearance and the corresponding depth of excavation in different reaches of a channel shall be clearly shown on the working drawing.
2. All excavations for silt clearance shall be carried out according to the working drawing mentioned above or as directed in writing by the Engineer-in-charge.
3. The spoils from silt clearance of channel shall be spread evenly in the neighboring borrow-pits.
4. In the absence of borrow-pits, the spoil shall be spread evenly along the back of the bank, thus widening and strengthening it.
5. Care shall be taken not to heap spoil on the top of the bank, or to throw it in lumps on the outside so that it may not be blown in by wind or rain.

3.4.3 Measurement

The measurement shall be made for the actual net quantity as per the approved drawings in cu ft / or cu m, by taking measurements of trenches, pits, etc., otherwise measurement in ft / or cu m shall be made as per actual rammed / compacted earth.

3.4.4 Rate and Payment

Payment shall be made for the actual quantity as measured above in Cu ft / m at the corresponding unit rate of BOQ.

3.5 Earthwork for River Embankments

Except as otherwise provided herein, river embankment shall be made to the alignments, grades and dimensions shown on the approved drawings or established by the Engineer-in-charge in writing and shall also be in complete conformity with the corresponding requirements set forth in the section, excavation and embankment (Earthwork General) the Specification.

3.5.1 Preparation of Surface

After the site clearance work has been completed, the ground surface under all embankments to be completed shall be ploughed thoroughly to a depth of not less than 9 inches, moistened, if so required, and completed as specified herein.

3.5.2 Borrow-Pits

The borrow-pits for river embankments shall conform to the following specifications: -

1. The borrow-pits shall be on the river side of the embankments only and no excavation whatsoever shall be done in the land side without written orders of the Engineer-in-charge.
2. No borrow-pits shall be excavated within 150 feet of the toe of the bank in the river side for new embankments. Borrow-pits, 150 to 200 feet away, shall not be deeper than 6 feet, and 200 to 300 feet away, not deeper than 8 feet. Beyond 300 feet they can be of any depth. For repairs, raining and strengthening of the existing embankment and providing berms etc. earth may be taken from 100 to 150 feet. From 100 to 110 feet the pits shall not be deeper than 3 feet, from 110 to 130 feet not deeper than 4 feet, and from 130 to 150 feet, not deeper than 5 feet.
3. Borrow-pits shall be allowed on the land side of embankment only, if this is absolutely unavoidable. In such cases pits, shall not be nearer than 80 feet of the land toe of embankment. The depth of the pits from 80 to 120 feet shall not exceed 2 feet and beyond that the maximum permissible depth is 5 feet.

3.5.3 Key Trench and Sand Core

1. The key trench shall be excavated true to alignment and section specified. Its bed shall be taken correct to the level shown in the approved drawings or as directed by the Engineer-in-charge and extra excavation shall be filled in with pure sand of the same quality as in the core. This extra filling shall be done by the contractor at his own expense, if he is responsible for this extra excavation.
2. Shoring and strutting necessary for the excavation of the trench to the specified dimensions shall be provided as per Specification at the expense of the contractor.
3. In the event of slips during excavation, the trench of the front slope of the main embankment shall be remade to the correct slopes and bed levels, and all loose and friable material removed from the bed by the contractor before filling is commenced. No claim for remaking the slopes, removing loose and friable material or extra filling the side or slope or bed shall be entertained.
4. The excavated stuff shall be temporarily stacked in stock piles and finally deposited as directed by the Engineer-in-charge.
5. No portion of the trench, however small, shall be filled in unless approved by the Engineer-in-charge.
6. The key trench shall be measured and all deaden or other distinctive marks removed. Such removal shall be inspected by the Engineer-in-charge before filling is commenced.

7. The sand, to be filled in the core, shall be obtained from an approved source. The sand shall be also approved on the site of sand coring by the Engineer-in-charge or his authorized subordinate before the filling is commenced. In the event of unauthorized filling prior to the approval of the trench, the contractors shall forthwith remove the filling to the correct bed level at his own expense, when so directed by the Engineer-in-charge.
8. Sand shall be filled in 6 inches layers up to specified depth and properly compacted. Filling beyond sand core depth with earth shall not be commenced before the top level have been checked and approved by the Engineer-in-charge or his authorized subordinate.
9. If the bank is to have a sand core, the sand filling, unless otherwise specified or directed by the Engineer-in-charge, shall be laid side by side with the layers of embankment up to the height specified.

3.5.4 Measurement

The measurement shall be made for the actual net quantity as per the approved drawings in cu ft / or cu m, by taking measurements of trenches, pits, etc., otherwise measurement in ft / or cu m shall be made as per actual rammed / compacted earth.

3.5.5 Rate and Payment

Payment shall be made for the actual quantity as measured above in cubic foot at the corresponding unit rate of BOQ.

3.6 Earthwork on Canals

Except as otherwise provided herein, earthwork on irrigation canals shall be finished to the alignments, grades and dimensions shown on the approved drawings or established by the Engineer-in-charge in writing and shall, in all respects other than those specified herein, be in complete conformity with the corresponding requirements set forth in the section, Excavation and Embankment (Earthwork General) Specifications.

3.6.1 Actual Excavation

Excavation shall be done strictly according to the instruction of the Engineer-in-charge. Normally, it shall be done in lifts of 2 feet to 5 feet. In each chain each lift will be completed as far as possible, before the one below is commenced. Care shall be taken that the final completed width of the channel is in no place exceeded. All gangways, rail or roadways and stepping shall be left within the channel and not cut into the slope. The final dressing of the slope shall then consist of digging only, and no filling or making up will be necessary. Excavation shall preferably be done by first cutting a center trench with vertical sides and then trimming the slopes.

3.6.2 Construction of Banks

The embankment for the canal shall conform to following specifications: -

1. The banks shall be constructed according to the approved profile.
2. Earth shall be taken from an approved source, borrow-pits in the bed of channel or outside or spoils as actually specified, and shall be free from roots, grass, shrubs or other foreign matter liable to decay.
3. In case distributary, if the earth obtained from cutting is inadequate for making the bank, extra earth required shall preferably be obtained by widening the bed of the channel itself. The bed may be widened to three times the normal width. Such widening shall be of the same amount through each length of low ground and not very frequently.

3.6.3 Borrow-Pits

The borrow-pits for canal embankments shall conform to the following specifications: -

1. Borrow-pits shall be dug only where unavoidable spoil for the formation of the banks shall be laid along the channel, if possible, in preference to taking it from borrow-pits.
2. No borrow-pit shall be dug within 10 feet of the toe of the bank, and its depth exceeding 2 feet the distance from toe of the bank to top edge of pit shall not be less than 15 feet.
3. If directed by the Engineer-in-charge to have a borrow-pit in the bed of the channel a berm of 5 feet from the inner toe of the bank shall be left on either side. Each pit shall be separated from the other by a berm equal to half the length of the pit. The depth of these pits shall in no case exceed 1 to 2 feet below the bed of the channel. In case of a channel which is not expected to receive silt during its running, no pit shall be dug below the bed level. Pits shall also not be dug within 20 feet of the masonry work or the cattle track across the channel.
4. Borrow-pits shall be as shallow as possible and not more than one foot deep in the cultivated areas required temporarily. In lands permanently acquired the maximum depth shall normally be 3 feet. In no case a borrow-pit deeper than 5 feet shall be allowed within a distance of 300 feet from the front toe of the bank.

3.6.4 Measurement & Payment

1. Measurement for payment for excavation, for irrigation canals will be made of the material in excavation only, regardless of the method of excavation. Measurement for payment for excavation for canals, will include all excavation within and over-excavation below the bed level of the canal prisms, regardless of whether the excavation for structures or other required works precedes or follows excavation of the canal prisms. The canal prism for any given canal is defined as the volume bounded by the designated bed level of the canal, the specified side slopes of the canal projected to the natural surface level, and the natural surface for any particular reach of the canal. The applicable canal prism, thus defined, shall be projected throughout the entire length of the canal in which it applies, including structure sites.
2. The material excavated from the canal shall be used for the embankment formation; therefore, no payment shall be made to the contractor for this excavation. However, in case the excavated material is found to be surplus / unsuitable, payment will be made at the unit rate per cubic meter.

The amount tendered shall be full payment for completion of the work specified. Excavation for Canals, including all costs in connection with clearing and stripping, as required; excavation of the material specified; transporting the excavated material to and placing in spoil banks; placing the excavated material in embankments not requiring compaction, channels to be filled, and other designated locations, except for embankments to be compacted and backfill; and all incidental operations thereto are included. Payment will be made under this item of the Bill of Quantities for excavation of slide materials from slides which were beyond the control of the contractor and for excavation of potential slide areas within and adjacent to the canals. No separate or additional payment will be made under this item of the Bill of Quantities for excavation performed outside of the canal prisms, except for over-excavation below the designated bed level, or for removing and disposing of sand, sandy soils and other materials deposited by the wind, drifted or washed into the excavated canal prism. No separate or additional payment will be made under this item for any excavation of structures or works to protect the works under these specifications from rains, surface run-off, floods, flow in and overflow of nullahs or other natural waterways, canals or water resources, or failure of protective works. Unit for measurement and payment should be cubic feet or cubic meter.

3.7 Clearing & Grubbing for Roads, Building, Canal etc.

This work shall consist of removing to a specified depth, (as up to 6 inches) grubbing of all surface objects and disposing off all vegetation, bushes, stumps, roots trees with less than 150mm girth, rubbish debris and all other objectionable material within the limits of the formation (Road, Building, Canal Bed, Embankment formation etc.) including slopes both in filling and cutting and easement areas.

3.7.1 Construction Requirements

The contractor shall demarcate limits of the construction including slopes and the Engineer will designate all trees, shrubs, plants and other objects to remain and the Contractor shall preserve all such things designated by the Engineer to remain and other will be removed accordingly.

3.7.1.1 Clearing / Grubbing

1. Clearing and grubbing shall consist of the complete removal and disposal as directed by the Engineer of all surface objects, shrubs, roots, stumps and other protruding obstructions not designated to remain in roadway cut areas, all surface objects to a depth of 30 cm (12 inches) all surface objects need to be removed. In roadway fill areas, where clearing and grubbing is required, same shall be carried out to the depth of 30cm (12inches) below the NSL (Natural Surface Level)
2. The work of clearing and grubbing shall include the careful preservation of any trees, vegetation, etc., outside the limits of construction and within any areas designated for being conserved.
3. All trees having a girth less than 150 mm (6 inches) and stems up to 600 mm height and situated within the format width and marked to be removed shall be filled and removed by the contractor. The excavation and removal of trees, roots and stumps including backfilling and compacting of holes and restoring the natural ground to the acceptable condition shall be responsibility of the contractor for which no extra payment other than notified under clearing and grubbing will be made the trees, stump and roots remains the property of the client and these will be delivered at the designated place.
4. Before bottom later of embankment is placed, contractor will grub up and remove without extra payment, any vegetation that may, in the meantime have grown on surface previously cleared and grubbed.
5. After clearing and grubbing, the compaction of the area will be restored to its original value without any extra payment. However, Engineer may direct in writing to the contractor for stripping (if so required) for compaction, compaction of natural ground, if the original compaction is less than the required for respective zone. Payment of these item will be made separately under the relative items used for such purpose.
6. Operation of clearing and grubbing shall in no way be deemed to affect any level of volume change of the area.
7. Within the areas between the limits of construction and the outer limits of clearing and grubbing all holes and other depressions shall be filled, all mounds and ridges cut down, and the area to sufficiently uniform contour that the Department's subsequent moving and cutting operations will not be hindered by irregularity of terrain.
8. Any useless timber, stumps, brush, roots, rubbish and objectionable material resulting from clearing and grubbing shall be disposed of within the limits of the right of way by burning; however, as an exception to this requirement, such materials may be disposed of on private property provided, the engineer is furnished with a written notice from the owner of the property giving permission for the disposal of the materials on

his or their property. Areas provided by the Contractor for disposal of the debris, etc., shall be out of sight of the project and at least 300 feet from the nearest roadway right of way line of the project, unless such materials are buried, in which case the requirement that the areas be 300 feet distant will be waived.

3.7.1.2 Protection and Restoration

The Contractor shall prevent damage to all pipes, conduits, wires, cables or structures above or below ground which are designated to be preserved. No land monuments, property markers, or official datum points shall be damaged or removed until the Employer/Engineer has witnessed or otherwise referenced their locations and approved their removal. The contractor shall so control his operations as to prevent damage to shrubs which are to be preserved. Protection may include fences and boards latched to shrubs, to prevent damage from machine operations. Any damage as a result of Contractor's operations shall immediately be rectified by him at his own expense.

3.7.1.3 Jungle Clearance

Jungle clearance shall comprise uprooting of rank vegetation, grass, brushwood, shrubs, stumps, trees and saplings of girth up to 2.5 ft. measured at a height of one meter above the ground level.

3.7.1.3.1 Uprooting of Vegetation's

The roots of trees and saplings shall be removed to a depth of 60cm below ground level or 30cm below formation level or 15cm below sub-grade level, whichever is lower. All holes or hollows formed due to removal of roots shall be filled up with earth rammed and levelled. Trees, shrubs, poles, fences, signs, monuments, pipe lines, cable etc., within or adjacent to the area which are not required to be disturbed during jungle clearance shall be properly protected by the contractor at his own cost and nothing extra shall be payable.

3.7.1.3.2 Clearance of Grass

Clearing and grubbing operation involving only the clearance of grass including removal of rubbish up to a distance of 50m. outside the periphery of the area under clearance shall not be measured and paid for separately. Its costs shall be deemed to be included in the unit rate for earthwork.

3.7.1.3.3 Measurements

The length and breadth shall be measured correct to the nearest cm and area worked out in square meters correct to two places of decimal.

3.7.2 Measurement

Clearing and Grubbing will be measured for payment only on areas so designated in writing by the Engineer or shown on the drawings. The quantity to be paid for shall be the number of square meters or sq.ft. satisfactorily cleared and grubbed any tree having girth less than 150 mm (6 inches) and stems of trees measured 600 mm above ground level shall fall under this item. Engineer shall ensure that a minimum of 500 SM area is designated for clearing and grubbing in any stretch of roadway for the sake of ease to construction activities. Clearing and Grubbing carried out by the contractor in borrow pits shall not be measured for payment When

the bill of quantities includes the item of clearing and grubbing and provides for payment for the work to be paid for, shall be measured in square meters or 100 square feet and the unit of measurement shall be square meter or 100 square feet. The measurement shall be limited to those locations designated on the plans or locations designated in writing by the Engineer.

3.7.3 Payments

The unit rate for clearing and grubbing shall be full compensation for all the work specified in this section and shall include all necessary hauling, furnishing and operation of equipment, disposal of debris, and cost of furnishing and compaction of material required for back filling of holes left by stumps and cost of restoration of area to its original form and other obstructions removed. It shall also include the cost for preserving all things designated to remain.

Where separately called for in the tender documents, the payment shall be made under:

Pay item Number	Description	Unit
3.7	Clearing & Grubbing	Square feet or square meter

3.8 Removal of Trees

This work shall consist of the removal of trees having girth of more than 150 mm (6 inch) and stems more than 600 mm (24”) above ground along with their roots to a depth, to ensure complete removal of roots and stumps and their disposal as provided in Special Provision or as directed in writing by the Engineer.

3.8.1 Construction Requirements

1. Such individual trees as the Engineer may designate and mark in white paint shall be left standing uninjured. All other trees to be removed shall be counted and an inventory prepared showing girth of the tree stem.
2. When necessary to prevent injury to other trees or structures or to minimize danger to traffic, trees shall be cut in sections from top downwards.
3. Hole or loose earth resulting from the removal of trees shall be filled and re-compacted to a degree of compaction of adjoining area. Any extra material required for such purpose shall not be measured for payment.

3.8.2 General Requirements

Contractor shall prevent damage to all under-ground utilities, such as pipes cables or conduits etc. For this purpose, if so required, removal of trees shall be carried out manually. Any under-ground or over-ground property damaged by the contractor shall be immediately repaired by the contractor at his own expense.

3.8.3 Measurements

Engineer and Contractor shall jointly measure the girth and number of trees to be removed under this item. Any tree having a girth of less than 150mm (6 inch) measured less than six hundred (600) mm (24 inch) above ground level shall not be measured under this item, as the same shall be removed under Section “Cleaning and Grubbing”.

3.8.4 Payments

The quantities determined as provided above shall be paid for at the contract unit price for the pay item mentioned below and shown in the Bill of Quantities which price shall be deemed to include all cost of labor equipment and incidental related to the respective Section.

Pay Item No	Description	Unit
3.8	Removal of trees, or stems of Girth 301 – 600 mm (12 to 24”)	Each

3.9 Earthwork for Roads

3.9.1 General Treatise of Earth/Road Excavation and backfilling

Earthwork will consist of all necessary work for the excavation and placing in embankment or backfill or disposal by dumping of earth, rock or other material from or to the roadway or adjacent thereto or from borrow areas, including the excavation of side and interception ditches, the removal of unsuitable subgrade material, the formation of lay byes, the widening of cuts and the flattening of cut slopes whether to obtain material for embankments or backfill, or to increase the stability of the slopes, clearing and grubbing, the selective removal of trees, stripping and the removal of existing obstructions within the approved cross section for excavation, in accordance with these specifications and in conformity with the lines, grades, sections, and dimensions shown on the drawings or as directed by the Engineer.

3.9.1.1 Soil Information

Any information concerning the properties of the soil or sub soil and other geotechnical information shown on the drawing or other documents forming part of the contract is for information only. The contractor is obliged to make his own assessment of prevailing site conditions. No claim for extra cost or time extension will be entertained based on the information provided.

The Contractor shall be deemed to have visited the site prior to making his bid and shall ascertain the nature of the earth and rock, its quantity, locations and suitability to meet the specified requirements, and he shall base his bid estimates solely on his own soil investigation. After the award of the contract no claim for a revision of bid prices depending on the sources of soil information will be entertained.

3.9.1.2 Explosives

1. Where explosives are used the Contractor shall provide suitable buildings or warehouses in approved positions for the storage of explosives, which shall be stored in the manner and quantity approved by the Engineer or as per relative laws of government. Such storage places shall be accessible only to authorized personnel. They shall be properly marked; all doors or accesses thereto shall be constructed of materials as directed by the Engineer and provided with secure locks and all necessary means for preventing access by unauthorized persons. The Contractor shall be responsible for the prevention of any unauthorized issue or improper use of any explosives. The handling of explosives shall be entrusted only to experienced and responsible men, to the satisfaction of the Engineer, and in conformity with the statutory regulations.
2. All drilling and blasting shall be done in such a manner as to bring the excavation as close as possible to the required cross sections, and to disturb as little as possible the material to be left in place. Blasting by means of drill holes, tunnels, or any other method shall be performed at the entire risk and responsibility of the Contractor who shall have no claim to payment for extra work occasioned by breakage outside the approved cross-sections or dimensions.
3. The greatest care shall be taken by the Contractor during all blasting operations to ensure that no injury be done to persons or damage to property or to the finished work. Shots shall be properly loaded and capped, and only a moderate charge shall be used in each hole. A record of all explosives used, showing locations and amounts, shall be kept by the Contractor for checking by the Engineer.

4. Where directed by the Engineer, the Contractor shall provide heavy mesh blasting mat for protection of persons, property and the work. If necessary, blasting shall be restricted to time prescribed by the Engineer.
5. The Engineer may prohibit blasting and order the rock to be excavated by other means, if, in his opinion, it would be dangerous to persons or adjacent structures, or is being carried out in a reckless manner. If traffic on the road has to be interrupted, the Contractor shall obtain approval of his schedule for such interruption from the proper authorities and shall satisfy the Engineer that he has obtained it. No extra payment shall be admissible for such arrangements as described here above.

3.9.1.3 Removal of Existing Obstructions

The pay items under Items shall include the cost of removal of all material regardless of its nature, encountered within the limits of the approved cross-section, including the removal and disposal, as required by the Engineer, of existing brick, stone, concrete or masonry, rock boulders or fragments, old pavements, culverts, bridges or parts thereof, retaining walls or any other material encountered during the excavation, unless a separate item exists for such features.

3.9.1.4 Removal or Diversion of Water

1. Except where provided for, no separate payment will be made for control of or removal of water during or after earthwork operations. The cost of sheeting, shoring, cofferdams, pumping and draining for earthwork or construction of road ways or embankments shall be included in the bid price for earthwork. The Contractor shall provide necessary facilities for dewatering and for draining or diverting watercourses when necessary for the protection of the contract work or where required by the Engineer.
2. The Contractor shall provide such drainage outlet ditches or canals as may be necessary to affect proper drainage before rain is expected. Such drainage ditches or canals for protection of work during construction and their maintenance and clearing to make them continuously effective during the work shall not be paid separately, but shall be deemed to be included in other items of work.
3. The Contractor shall also provide, fix, maintain and operate such engines, pumps, hoses, chutes and other appliances as are necessary to keep the accumulated water at a level required for the safety of the structures as directed by the Engineer.

3.9.1.5 Ditches

1. The Contractor shall construct side- ditches, interception ditches, and inlet and outlet ditches as shown on the Drawings or where ordered by the Engineer, whether for temporary or permanent drainage. In order to keep water away from the embankment, subgrade, and/or pavement during construction, the Contractor shall at all times ensure adequate drainage by scheduling ditch and outlet so that the drainage is operative before work is started on the embankment, subgrade or pavement. He shall clean and trim all such drainage ditches from time to time, so that there may be a free flow of water throughout the whole period of the Contract. Ditches shall first be trimmed according to approved cross-sections, and final trimming, including the repair of any damage that may have been done during the construction work, shall be carried out after the completion of the other construction work and shall be a condition for final approval and acceptance.
2. Unless otherwise specified in the bid schedule no separate payment will be made for the excavation of side ditches, interception ditches, inlet and outlet ditches.

3. Where indicated on the drawings or when required by the Engineer, the Contractor shall take cross-sections of existing stream channels, and in collaboration with the Engineer, mark them with details of the excavation required for the relocation of the stream channel. Work shall not proceed without written approval of the marked cross-sections by the Engineer.

3.9.1.6 Excavation for Culverts

Except where otherwise specified excavation and backfill for culvert and drainage pipes, except granular backfill or underfill to under drains, pipes or behind the abutment walls will not be paid for separately, but shall be considered as a subsidiary obligation of the Contractor covered under the contract price for the various classes of pipe culvert or pipes etc.

3.9.1.7 Landslides, Benches, Flattening of Slopes

The Engineer may order the removal of material resulting from landslides, the construction of benches in or above the cut slope or in the embankment slope or where in his opinion the slope shows signs of instability, the flattening of the slope. Payment of all such work shall be at contract prices in the bid schedule or in the relevant Item of these specifications as the case may be.

3.9.1.8 Survey and Leveling Prior to Commencement of Earthwork

The Contractor shall be responsible for the setting out of the work in accordance with the relevant Clause of the General Conditions of Contract. Notwithstanding that project drawings have been issued to the Contractor, the Contractor shall also be responsible for taking joint cross-sections on the proposed alignment of the road, submitting three copies of the plotted cross sections and longitudinal profile to the Engineer and obtaining the approval of the Engineer to such cross-section and longitudinal profile before any work in connection with Earthwork is commenced. These cross-sections and longitudinal profile shall be in the form and manner as instructed in writing by the Engineer.

3.9.1.9 Measurement and Payment

The quantities of the various classes of excavation or embankment to be measured for payment under the contract shall be limited to the lines and level as taken under clause 3.9 above. However, if the levels so taken differ appreciably from design levels the matter shall be referred to the client.

Excavation and filling beyond the lines and level shown on the drawings, approved profiles and cross-sections will not be paid for. The Engineer will decide the angle of the slope of cuts and fills as the work proceeds on the basis of evaluation of the soil characteristics. The actual lines of the cuts and fills as made will be duly measured and recorded by the Contractor. The Engineer will check these records and will approve the measurements, if correct, as a basis of payment. Excess of excavation shall be backfilled, as directed by the Engineer, with sub base materials or better fill material without extra payment to the Contractor; excess of fill may be either left in place or removed as required by the Engineer. The quantities of excavation, backfill and earthwork to be paid shall be covered under the respective section and shall be the number of cubic meters or 100 / cubic ft as the case may be and given in the respective section. The material shall be measured by the average end area method, except where the error may exceed plus or minus five percent as compared with the prismoid formula in which case the Engineer will authorize the use of the more accurate method. However, the

Contractor shall request such authority before he submits his quantities for approval. Quantities measured on the average end-area basis, once they have been submitted and approved, shall not be subject to review for the purpose of applying a more accurate method.

3.9.2 Removal of Existing Pavements

3.9.2.1 Scope and Description

Scope

The Scope of work envisage dismantling the pavement structure as a whole upto the top of the subgrade level for the reach or stretch of the road as designated on the drawings or identified by the ENGINEER

Description

The work specified in this section consists of removing and storing for re-use if so designated by the Engineer or otherwise disposing of all existing pavement materials such as bituminous surfacing, crushed rock or bricks, comprising the sub base , road edging / sidewalk, curb and gutter or flexible road surface where it is shown on the plans or ordered by the Engineer to be removed or where required to be removed by the construction operations.

3.9.2.2 Construction Methods

The method of dismantling or breaking of the pavement structure as a whole including removal of road edging, sidewalks, curb or gutter etc. shall be proposed by the Contractor along with the machinery or equipment to be employed and approved by the Engineer in accordance with requirements under the conditions. Except where specifically directed otherwise the contractor shall store all materials for use where directed by the Engineer. The Contractor shall be responsible for the materials until finally disposed of.

3.9.2.3 Measurement and Payment

Measurement

The item for removal of existing pavement designated on the plans will be measured in superficial area. The unit of measurement will be one hundred square feet. The quantity shall be determined by actual measurement before removal.

Payment

The unit rate shall be full compensation for all costs of complying with the provisions of this Section and includes costs of all materials, labor and machinery etc.

Payment Item No	Description	Unit
3.9.2	Removal of Existing Pavement	Per sq meter / or 100 sq.ft.

3.9.3 Scarification of Existing Road / Breaking of Road Pavement Layers

3.9.3.1 Description and Scope

Description

1. The scope of work under this section envisage breaking and removing a part or a layer of the existing pavement structure and removing of the dismantled material so that a new layer is placed after ensuring the specified compaction of the lower layer which has been left to be intact.
2. The second method of improvement of a damaged road stretch is to scarify or scrapping the sub base or base course layer and compacting the same after fulfilling the gradation and thickness requirements. Payment for the fulfillment of the gradation / thickness and compaction requirement will be made separately under the relevant subhead.

Scope

This work shall consist of scarification of existing road surface or breaking of existing road pavement structure to ensure bondage of new layer with the existing road pavement and to ensure drainage of water below the freshly laid base-course or surfacing layer. The surface on which the new base course or surface layer is to be constructed, shall be approved and accepted by the Engineer prior to placing the crushed stone base aggregate.

3.9.3.2 Construction Requirements

After the existing pavement structure broken off, the material shall be removed and disposed off outside the right of way, according to the satisfaction of the Engineer. The surface obtained after scarification or breaking the existing pavement shall be compacted to the density prescribed under the relevant section of this specification. Payment of such compaction shall be included in the contract price for this item of work. The method of scarification of road surface or breaking of pavement structure shall be proposed by the contractor and approved by the Engineer in accordance with the requirements under site conditions. The compaction of the lower un-scarified layer according to the prescribed limits shall be the responsibility of the contractor who has scarified the upper layers, the price of which is included in the scarification.

3.9.3.3 Measurement and Payment

Measurement

1. The quantity for a layer of the pavement structure broken and removed, to be paid for, shall be measurement in cubic meter or 100 cub. ft to a depth as shown in the drawings/cross sections or as specified by the Engineer and in the area earmarked by the Engineer for such purpose.
2. The quantity for road pavement structure scarified or scrapped, to be paid for shall be measured in Sq. meter or 100 sq. ft. as shown in the drawings/cross sections or as specified by the Engineer and in the area earmarked by the Engineer for such purpose.

Payment

The quantities as measured above shall be paid for at the contract unit price per cubic meter/cft of breaking of road pavement structure and per Sq. meter/sft of scarification of existing road pavement structure, for carrying out the works mentioned above including cost of labor, equipment, tools and incidentals necessary to complete these items.

Pay Item No	Description	Unit of Measurement
3.9.3 a	Breaking of a layer of Existing Road Pavement Structure	CM or 100 c.ft.
3.9.3 b	Scarification of Existing Road Pavement	SM or 100 s.ft.

3.9.4 Roadway and Borrow Excavation for Embankments

Description

The work specified in this Section consists of excavation of materials of whatever nature, encountered within the limit required for the proposed work, excluding structural excavation and shall include the removal, utilization and disposal of such materials, as required. It shall also include all excavation, hauling filling and placing, compaction, shaping and sloping necessary for the construction of all embankments, subgrades, shoulders and special backfills, in accordance with the required alignment, grade and cross sections shown on the plans. Free haul for the carriage of material for the construction of embankment which is considered to be included in the rate of roadway excavation or borrow excavation is 900m (3000ft). The work covered in this section includes:

1. Roadway Excavation
2. Borrow Excavation
3. Making Road Embankment

Classification of Excavated Material

All material excavated shall be classified as under:

a. Common Soil

Clayey, silty and sandy soils including small quantities of stone fragments, or gravel.

b. Gravel

Soil containing predominantly water borne stones of rounded shape of irregular size, occurring naturally.

c. Soft Rock

Rock formation requiring pick and crow bar operation or any rock that can be removed with blade of 200 HP bulldozer.

d. Medium Rock

Rock that cannot be removed with a blade of 200 HP. Bulldozer But can be removed by the Rippers

e. Hard Rock

All other rock formations requiring blasting. Because it cannot be removed with Rippers of a 200 HP Bulldozer

For the purposes of making embankment, common soil and gravel are to be considered as "COMMON MATERIALS" and soft rock, medium and hard rock as "ROCK MATERIALS"

3.9.4.1 Classification of Roadway/Borrow Excavation

Roadway Excavation/Borrow Excavation shall further be classified as “Common Excavation” or “Rock Excavation” (common excavation shall include all the materials of whatever nature encountered but not rock excavation).

a) Common Excavation

Common excavation shall consist of the removal and satisfactory disposal of all eolian, alluvial and residual materials, in place unaltered and un weathered strata which are not firm or rigid enough to possess all the characteristics of “Rock Excavation” Boulders of less than one quarter (1/4) cubic meter volume shall also be classified as “Common Excavation”. Eolian and alluvial materials consist of gravel, shale, volcanic ash, loess dunes and loams, sands and clays or any combination of these materials and termed as Common Excavation.

b) Rock Excavation

Rock excavation includes firm and rigid igneous, metamorphic and sedimentary rocks. boulders larger than (1/4) cubic meter volume will also be considered as “Rock Excavation”, provided these are firm and stable lying in continuous bed more than 50% by volume as compared to other type of materials in the total mass the term Hard, Medium or Soft rock is described as above in Para 3.9.4.

3.9.4.2 Types of Excavations

- a) Roadway Excavation
- b) Borrow Excavation

a) Roadway Excavation

Road Excavation shall comprise all excavation that is not classified as structural excavation carried out within the limits of roadway including permanent drainage ditches and side slopes in cut.

General: It shall consist of the excavation for the road in “cutting section” and utilization of all useful materials necessary for the construction of the roadway in “fill section”. It shall also include the excavation and disposal of muck, clay, rock or any other material that is unsuitable in its original position within the limits of the roadway including the removal of all suitable material lying within the roadway limits which is necessary to remove in order to excavate the unsuitable material.

Protection of Work: While the excavation is being done and until the work is finally accepted, the contractor shall take the necessary steps to protect the work to prevent loss of material from the roadway, due to action of wind or water. During construction of the roadway, the subgrade shall be maintained in such condition that it will be well drained at all times.

Removal of Trash: Vegetation etc. On previously graded roadways, where no clearing and grubbing of the roadway is called for on the plans, all vegetation, bushes, shrubs, saplings etc. and including any trees for which removal is specifically called for in the plans, shall be removed as provided in Section Clearing and Grubbing, as a part of the work, under this Section.

b) Borrow Excavation

General: Borrow shall consist of the material obtained from the authorized borrow pits. It shall include only material that is suitable for the construction of roadway embankments or

other work of constructing embankments covered by the contract, and also unsuitable material that is necessary to excavate, as determined by the Engineer, to obtain suitable material. Borrow shall be resorted to only when sufficient quantities of suitable material are not available, as herein prescribed, from roadway excavation, to properly construct the embankment, subgrade and shoulders and to complete the backfilling of structures. In no case shall material be borrowed until so ordered by the Engineer, and then only from the designated borrow pits. No borrow pits shall be opened until the Engineer has approved their location and, where borrow is to be measured in pits, their surface has been cross sectioned. Unless otherwise indicated on the plans, the right of way for all borrow areas necessary for the completion of the work will be furnished by the department.

Borrow Area Furnished by the Contractor: At the option of the Contractor in lieu of obtaining borrow from areas furnished by the Department, he may obtain borrow from other areas furnished by him, provided the Engineer determines the material from such areas meets the Departments standards, and other requirements for suitability for use in the particular sections of the work in which it is placed, and further provided that any increase in hauling or other costs shall be absorbed by the Contractor. No borrow material shall be obtained from any substitute areas until the Contractor has requested, in writing, permission to use such areas, and the Engineer has approved, in writing, the use of the particular areas and has cross sectioned the surface. Upon such written approval by the Engineer, the substitutes areas shall be considered as designated borrow areas.

Excavation Requirements: When borrow material is to be measured, if needed, the borrow pits shall be excavated neatly and the bottom and edges so shaped that accurate measurement are taken. Where the plans show the depth and width of excavation, such depth and width shall be considered approximate only and shall be subject to variation as directed. In borrow pits furnished by the Department; no material shall be excavated within three feet of the adjacent property lines.

Provisions for Drainage: Where shown on the plans the ditches for drainage of the borrow pits or roadway shall be constructed. The excavation of such drains shall be classified as borrow, and suitable material thus obtained, used, where required, on the works.

Sequence of construction: If the plans indicate section within which a significant quantity of borrow is required in order to establish a balance within the limits of such sections, then except as might be permitted otherwise in writing by the Engineer, the Contractor shall construct first those sections showing no borrow, such that all suitable surplus material therein will be utilized. In order to meet this requirement if the Contractor is required to haul a distance greater than the distance indicated on the plans overhaul be paid for as specified in the Section Overhaul of Excavation.

c) Haul Roads

The Contractor shall provide and maintain at his own expense all necessary service roads necessary for hauling the material over the shortest practicable route as determined by the Engineer, to the points where it is to be used for doing all operations pertinent to the execution of work covered under this section. The Department will obtain any necessary property easements for haul roads leading to the pits furnished by it.

3.9.4.3 Construction Requirements

1. All suitable material excavated within the limits and scope of the project shall, unless provision is expressly made to the contrary in these specifications, be used in the most

effective manner for the formation of the embankment, for widening the road formation, for backfill, or for other work included in the contract.

2. Any material surplus to this requirement or any materials declared in writing by the Engineer to be unsuitable shall be disposed of and leveled in layers by the Contractor outside the right of way or as directed by the Engineer. The material unsuitable common material is that material whose soaked CBR (96 hours) is less than five (5) percent or it falls under A-6 OR A-7 AASHTO soil classification.
3. When unsuitable material is ordered to be removed and replaced, the soil left in place shall be compacted to a depth of 20 cm (8") to the density prescribed under the relevant "compaction" paragraph of the chapter MAKING EMBANKMENT. Payment for such compaction shall be included in the contract prices for the excavation of unsuitable materials.
4. If the unsuitable material which is to be removed is below standing water level and the replacement material is gravel or a similar self-draining material of at least 30 cm (1 ft) in depth, the compaction may be dispensed with, if approved by the Engineer.
5. During of roadway construction, the road bed shall be maintained in such a way that it will be well drained at all times.
6. Borrow Pits shall be located so that the nearest edge of the pit is at least thirty (30) meters from the roadway toe of slope unless otherwise directed by the engineer.
7. Where between two successive cross section of the road, the propertied of rock boulders, in size larger than a one quarter of a cubic meter, to earth is more than 50%, the excavation will be considered wholly as rock.
8. Blasting by means of drill holes or any other methods shall be performed at the entire risk and responsibility of contractor. Care shall be taken to ensure that no injury be done to persons or properties or to the finished work. Blasting shall be restricted to the hours prescribed by the local authorities or the Engineer.

3.9.4.4 Measurement

1. Only material which is surplus to the requirements of the component of the project or is declared in writing by the Engineer to be unsuitable will not qualify for payments under pay items No.4-5-a, 4-5-b, 4-5-c and 4-5-d as the case may be.
2. The cost of excavation of material which is used/utilized anywhere in the project shall be deemed to be included in the pay items relating to the parts of the work where the materials is used.
3. The under mentioned pay items No.4-5-a to 4-5-b shall include the cost of obtaining the consent of the owner or tenant of the land where the disposal of surplus or unsuitable materials is made.
4. Unsuitable or surplus material shall be measured in its original position and its volume shall be calculated in cubic meters or cubic feet.

3.9.4.5 Payment

1. The unit rate shall be full compensation for all costs or complying with the provisions of this section regarding roadway excavation in accordance with Drawings and as directed in writing by the Engineer.
2. The quantities determined as provided above shall be paid for, at the contract unit price respectively for each particular pay items listed below and shown in the bill of Quantities which prices and payment shall constitute full compensation for all costs involved in the proper completion of the work prescribed in this item.

Pay Item No	Description	Unit of Measurement
3.9.4.1. A	Excavate Unsuitable Common Material	Cubic meter or 100 Cft.
3.9.4.1. B	Excavate Unsuitable Rock Material	

	a. Soft Rock Material	Cubic meter or 100 Cft.
	b. Medium Rock Material	Cubic meter or 100 Cft.
	c. Hard Rock Material	Cubic meter or 100 Cft.
3.9.5	Excavate Surplus Common Material	Cubic meter or 100 Cft.
3.9.5.1	Excavate Surplus Rock Material	
	a. Soft Rock Material	Cubic meter or 100 Cft.
	b. Medium Rock Material	Cubic meter or 100 Cft.
	c. Hard Rock Material	Cubic meter or 100 Cft.

3.9.5 Excavation of Un Suitable / Surplus Material

The work consists of excavation and disposal of unsuitable or surplus material arising from roadway excavation, which is declared in writing by the Engineer to be unsuitable for use or surplus to the requirements of the project. When excavation of unsuitable material requires special attention for a known condition on a specific project, construction requirements and payment shall be covered under relevant provisions.

3.9.5.1 Rock Excavation

Rock excavation shall be classified in grades as given in table No.10 of heading 3.13 of these specifications.

3.9.5.2 Construction Requirements

1. All suitable material excavated within the limits and scope of the project shall be used in the most effective manner for the formation of the embankment, for widening of roadway, for backfill, or for other work included in the contract.
2. Any material surplus to these requirements or any material declared in writing by the Engineer to be unsuitable shall be disposed of and leveled in thin layers by the Contractor outside the right of the way within 7 km of excavation. The Engineer shall decide regarding the unsuitability of the material by conducting appropriate laboratory tests.
3. When unsuitable materials are ordered to be replaced, the soil left in place shall be compacted to a depth of 20cm to the density prescribed. Payment for such compaction shall be dispensed with if approved by Engineer.

3.9.5.3 Measurement and Payment

a. Measurement

When the Contractor is directed to excavate unsuitable material below the surface of original ground in fill areas, the depth to which these unsuitable materials are to be removed will be determined by the Engineer. The Contractor shall schedule his work in such a way that authorized cross sections can be taken before and after the material has been removed. Only material which is surplus to the requirements of the project or is declared in writing by the Engineer to be unsuitable will qualify for payments.

The cost of excavation of excavation of material which is used anywhere in the project shall be deemed to be included in the pay item relating to the part of the work where the material is used.

The under mentioned Pay item shall include the cost of obtaining the consent of the owner or tenant of the land where the disposal of surplus or unsuitable material is made. Unsuitable or surplus material shall be measured in its original position and its volume shall be calculated in cubic meters using end area method.

b. Payment

The quantities determined as provided above shall be paid for at the contract unit price respectively for each of the particular pay items shown in the Bill of Quantities which prices and payment shall constitute full compensation for all costs involved in the proper completion of the work prescribed. Please see also section 3.9.4.5 of these specifications.

3.9.6 Structural Excavation and Backfill

Description

The work specified in this Section consists of the excavation for bridge foundations, box culverts, pipe culverts, storm sewers and all other pipe lines, retaining walls, headwalls for pipe culverts and drains, catch basins, drop inlets, manholes and similar structures not otherwise provided in these specifications and in accordance with the Drawings or as directed by the Engineer. It shall also include furnishing of all necessary equipment for (1) the construction and removal of cofferdams, sheeting, bracing etc., (2) pumping or otherwise unwatering the foundation; (3) the removal and disposal of any existing structures or portions of structures not covered by other items in the Contract, including the foundations, abutments, piers, wings, and all other materials, obstructions, etc., found necessary to clear the site for the proposed work; (4) backfilling, disposing of surplus material which is not required for backfill, in a manner and at locations as directed in writing by the Engineer and final cleaning, as may be necessary for the proper execution of the work.

Excavation Classification

All materials excavated shall be classified and considered according to section 3.9.4 as common soil, gravel, soft rock and hard rock excavation according to the material encountered.

3.9.6.1 Construction Requirements

General

All substructures, where practicable, shall be constructed in open excavation and, where necessary, the excavation shall be shored, braced, or protected by cofferdam in accordance with approved methods. In case, the contractor has excavated additional volumes than specified the contractor shall at his expense backfill the volume with approved material as directed by the Engineer

1. Depth of Excavation

All excavation shall be carried out to foundation level satisfactory to the Engineer, All excavation located in the bed of a stream or canal shall be carried to a depth of a least four feet below the permanent bed of the stream, or as shown on the plans based on the designed scour depth or otherwise a firm footing is established on solid rock before such depth is reached, and to such additional depth as may be necessary to eliminate any danger of scouring or undermining. Wherever rock bottom is encountered, the excavation shall be done in such manner as to allow the solid rock to be exposed and prepared in horizontal beds for receiving the masonry. All loose and disintegrated rock or thin strata shall be removed. All foundations shall be inspected and approved by the Engineer prior to placing of masonry.

2. Preparation of Foundation for Footing

1. The foundation pits shall be excavated to permit the placing of the full widths and lengths of footings shown on the Plans, with full horizontal beds. Corners or edges of footings shall not be rounded or undercut.
2. All rock or other hard foundation material shall be free from all loose material, cleaned and cut to firm surface.

3. When masonry is to rest on an excavated surface other than rock, special care shall be taken not to disturb the bottom of the excavation, and the final leveling of the grade shall not be made until just before the masonry is to be placed.
4. **COMPACTION:** The bottom of the trench shall in all cases be compacted to 95% Standard AASHTO Max. Dry density. Where the bottom of the trench is under cut and back filled with selected material, this material shall be compacted to at least 95% Standard AASHTO dry density or to such other value as the Engineer may direct.

3. Preservation of Channel

Unless otherwise shown on the Plans no excavation shall be made outside of caissons, cribs, cofferdams, or sheet piling, and the natural stream bed or canal adjacent to the structure shall not be disturbed unless so permitted by the Engineer. If any excavation or dredging is made at the site of the structure before caisson, cribs or cofferdams are sunk in place, backfill all such excavations to the original ground surface or river bed with material satisfactory to the Engineer.

Materials deposited within the stream area from foundation excavation or otherwise, shall be removed and the stream left in its original condition, unless otherwise shown on the Plans or ordered by the Engineer.

4. Cofferd Dams and Cribs

General

For substructure work, the Contractor shall submit drawings showing his proposed method of construction of coffer dam. Contractor shall not start work until the Engineer has approved such drawings

Construction: Wherever practicable all foundations shall be constructed by open excavation and the foundation openings shored, braced, or protected by cofferdams in accordance with approved methods. Cofferdams or cribs for foundation construction shall in general be carried well below the bottom of the footings and shall be well braced and as watertight as practicable. The interior dimensions of cofferdams shall be such as to give sufficient clearance for the construction of forms and the inspection of their exteriors and to pumping outside of the forms. Cofferdams or cribs which are tilted or moved laterally during the process of linking shall be righted or enlarged so as to provide the necessary clearance and this shall be solely at the expense of the Contractor

Green concrete protection: Cofferdams shall be so constructed as to protect green concrete against damage from a sudden rising to the water and to prevent damage by erosion. No timber or bracing shall be left in cofferdams or cribs in such a way as to extend into the substructure masonry except where might be so permitted, in writing, by Engineer.

Depth: For placing footings in the dry, the Engineer may require cofferdam sheeting to be driven to an elevation six feet below the elevation of the bottom of the footings and require sufficient pumping equipment to dewater and maintain the cofferdam in a comparatively dry condition.

Additional Requirements: When conciliations are encountered which, in the opinion of the Engineer, render it impracticable to dewater the foundation before placing masonry, he may require the construction of a concrete foundation seal of such dimensions as may be necessary. The foundation shall then be pumped out and the balance of the masonry placed in the dry. When weighted cribs are employed and the weight is utilized to partially overcome the hydrostatic pressure acting against the bottom of the foundation seal, special anchorage such as dowels or keys shall be provided to transfer the entire weight of the crib into the

foundation seal. During the placement of foundation seal, the elevation of the water inside the cofferdam shall be controlled to prevent any flow through the seal, and if the coffer dam is to remain in place, it shall be vented or ported at low water level.

Contractor's Drawings: For sub-structure work, the Contractor shall submit upon request, drawings showing his proposed method of cofferdam construction and other details left open to his choice or not fully shown on the Engineer's drawings. The type and clearance of cofferdams, in so far as such details affect the character of the finished work, will be subject to the approval of the Engineer, but other details of design will be left to the Contractor, who will be responsible for the successful construction of the work.

Removal: Unless otherwise provided, cofferdam or cribs, with all sheeting and bracing, shall be removed by the Contractor after the completion of substructure. The removal shall be affected in such manner as not to disturb or mar the finished masonry.

5. Disposal of Surplus Material

The excavated materials shall generally be used for backfilling and in constructing embankments over and around the structure. All excavated material not used for backfilling shall be disposed of as directed by the Engineer. When suitable, this material, in general, shall be used in the construction of roadway embankments, but material that is unsuitable or not required for this purpose shall be disposed of in such a manner as not to impair the appearance or utility of either the roadway or the waterway. In no case shall it be placed in the channel of the stream.

6. Pumping

Pumping from the interior of any foundation enclosure shall be done in such a manner as to preclude the possibility of any portion of the concrete materials being carried away. No pumping shall be done during the placing of concrete, or for a period of at least 24 hours thereafter, unless it is done from the suitable sump separated from the concrete work by a watertight wall. Pumping to unwater a sealed coffer dam shall not commence until the seal has set sufficiently to withstand the hydrostatic pressure.

7. Inspection

After each excavation is completed the Contractor shall inform in writing to the Engineer and no masonry shall be placed until the Engineer has approved the depth of the excavation and the character of the foundation material.

3.9.6.2 Backfilling

General

Backfill material shall be made with the following material:

1. Common backfill material from structural excavation or brought from outside
2. Granular backfill of selected material from structural excavation or brought from outside
3. Rock material of small size shall be permitted in the backfilling of structures or walls subject to the approval of methodology by the Engineer Material shall be either from the structural excavation or brought from outside

3.9.6.2.1 Specifications for Materials and Laying

Common Back fill Material obtained from the structural excavation or brought from outside

Common material shall consist of earth free from large lumps, wood and other organic materials and of a quality acceptable to the Engineer. It shall be placed in the position and to the required depths shown on the Drawings and/ or as required in writing by the Engineer and it shall be well compacted in layers not to exceed twenty (20) cm / eight (8) inches in depth to the density, 95 percent of maximum dry density as per AASHTO T-180 (D).

Granular Backfill material

Granular backfill where-ever directed shall be placed in the position and to the required depth, shown on the drawings or where and as required in writing by the Engineer and it shall be well compacted in layers not exceeding twenty(20)cm/eight(8) inches in thickness to 100 percent of Maximum dry density as per AASHTO T-180(D). In case of water logged areas, the thickness of the layer shall not exceed fifty (50) cm / twenty(20) inches in depth or as directed by the Engineer to the density as mentioned above.

If the material satisfying the requirements of coarse sand falling under soil classification A-3(AASHTO) is used, it shall be ensured that the same is confined properly as approved by the Engineer.

Rock Material from structural excavation or brought from outside

The rock material whose individual sizes are not more than 30cm/12 inches shall be placed in the position to the required depth as specified and the voids shall be filled in layer with fine material approved by the Engineer. The compacting efforts shall be made so as to achieve the desired compaction approved visually by the Engineer. The depth of the layer in any case shall not exceed (60) sixty cm. / 24 inches.

Rock backfills will not be placed within two meters from concrete faces of any structure

3.9.6.2.2 Specified Requirements for Backfill Locations

1. All spaces excavated and not occupied by abutments, piers or other permanent works shall be refilled with earth or granular fill as approved by the Engineer up to the surface of the surrounding ground with a sufficient allowance for settlement. All such back fill shall be thoroughly compacted up to the satisfaction of the Engineer and generally top surface properly leveled
2. The fills behind the abutment walls of all bridges and culverts which act as subgrade of approach roads should be of granular material fulfilling the requirement of coarse sand falling under the classification A-3(AASHTO) The width should not be less than 1½ meter or 5 ft meter along the road alignment or as directed by the Engineer or shown on the drawings ,The granular backfill shall start from the natural ground surface and end up to the top of the subgrade level and in no case be less than one meter or 3ft.
3. The fill behind abutments and wing walls of all bridge structures shall be deposited in well-compacted, horizontal layers not to exceed twenty (20) cm. in thickness. The common backfill in front of such units shall be placed first to prevent the possibility of forward movement.
4. Special precautions shall be taken to prevent any wedging action against the masonry, and the slope bounding the excavation for abutments and wing walls shall be destroyed by stepping or roughening to prevent wedge action. Jetting of the fill behind abutments and wingwalls will not be permitted.
5. Fill placed around culverts and piers shall be deposited on both sides to approximately the same elevation at the same time. Where the Contractor does not have proper

equipment to ensure compaction in restricted areas, Engineer may allow backfill with sand saturation method, at no extra cost to the Client.

6. Adequate provision shall be made for the through drainage of backfill. Weep holes. With perforated PVC. drainage pipes 19 mm or ¾" diameter will be provided along the slopes and the spacing will be decided by the Engineer.
7. No backfill shall be placed against concrete or masonry structure before fourteen (14) days of placement and backfilling shall be carried out on both sides of the structure simultaneously.

3.9.6.2.3 General Requirements for All Structures

1. Backfilling to the original ground surface of openings made for structures, with a sufficient allowance for settlement shall be a part of the work of excavation, although the Engineer may require that the material used in making the backfill be obtained from a source entirely apart from the structure. All material used for backfill shall be of quality acceptable to the Engineer and shall be free from large lumps, wood, or other extraneous material.
2. In case of backfilling of a road cut for bridge or culvert abutments as mentioned in Section 3.9.6.2.2 (2), if the excavated material from the structural excavation does not fulfill the specified requirement of coarse sand, the same material shall be brought from outside and paid separately

3.9.6.3 Replacing of Pavement Removed for Construction or Culverts Sewers etc.

Where existing pavement, curb, gutter, sidewalk, or valley gutter is removed only for the purpose of constructing or removing box culverts, pipe culverts, storm sewers, inlets, manhole etc., such pavement etc., shall be replaced and restored to as good condition, as determined by the Engineer, as before removal and without direct compensation there from, the replaced pavement etc., shall be of the same or similar type as the removed except where permission is given by the Engineer for the use of other type.

3.9.6.4 Cleaning Up

Upon completion of the work, the Contractor shall leave the structure and all adjacent areas affected by these operations in a neat and presentable condition and shall remove and clear up all temporary structures, rubbish and surplus material and leave the space under the structure unobstructed and in such shape that drift will not collect nor scour be induced. All material from existing structures that have been removed by him shall be piled neatly on the bank or otherwise disposed of as directed by the Engineer. False work piling shall in general be pulled, except that, when permitted by the Engineer, they may be cut or broken off two feet below the ground line or stream bed.

3.9.6.5 Method of Measurement

Excavation will be measured in its original position by the cross-section method to determine the amount of material removed and will be that material actually removed below the original ground line or stream bed, but not including that shown on the plans to be paid for as Regular Excavation, (Section 4-5). No measurement will be made for material removed in excavation for footings of foundations outside of an area which is bounded by vertical planes one foot outside of the limits of the footing and parallel thereto.

When excavation for material below plan grade is called for on the Plans or authorized by the Engineer, the measurement shall include both the material excavated below grade and the material used for back fill.

3.9.6.6 Measurement and Payment

Measurement

1. Structural Excavation

The quantities of structural excavation to be paid for shall be the number of cubic meters of material measured in its original position computed by the average end-area method, and excavated to the satisfaction of the Engineer.

Structural Excavation will be classified for measurement and payment as "Structural Excavation in Common Material", "Structural Excavation in Common Material Below Water Level", "Structural Excavation in Rock Material" and according to whether the excavation is in earth or rock and according to whether the excavation is above or below the water level which is the constant level to which the water naturally rises in a foundation pit.

The volume of earth or rock to be measured for structural excavation shall consist of a prismoid bounded by the following planes: -

- 1) The vertical limits for computing pay quantities will be vertical planes 50 centimeters outside of the neat lines of footings or foundations as shown on the Drawings or as directed by the Engineer.
- 2) The upper limit for payment of structural excavation shall be the ground surface as it existed prior to the start of construction operations, except where structural excavation is performed within roadway excavation or ditch excavation areas, the upper limit shall be the planes of the bottom and side slopes of said excavated areas.
- 3) The lower limits for computing pay quantities of structural excavation or structure backfill shall be a plane at the bottom of the completed footings, foundations, structures or lean concrete. Measurement for structural excavation shall not include material removed below the footing grade and beyond specific limits to compensate for anticipated swell or as a result of effective swell during pile driving, or additional material resulting from slides, slips, cave-ins, silting or fillings, whether due to the action of the elements or to carelessness of the Contractor. The depths of the footings shown on the drawings are approximate only and any variation found to be necessary during construction shall be paid for at the contract unit price.

2. Granular Backfill

The quantities of Granular Backfill to be paid for shall be the number of cubic meters of material laid and compacted in place within the line of structure and limits defined above, computed and accepted by the Engineer.

3. Common Backfill

The quantities of Common Backfill to be paid for shall be the number of cubic meters of material laid and compacted, placed within the lines of structures and limits defined above and accepted by the Engineer.

The work of Excavation for Structures will be measured by volume. The unit of measurement shall be one cubic meter or hundred cubic feet. and the backfill coarse sand material if brought from outside will also be measured accordingly.

Payment

The unit rate shall be full compensation for all costs of complying with the provisions of this Section and includes costs of unwatering of foundations, removal and disposal of surplus

material, back – filling and final cleaning as may be necessary for the proper execution of the work.

Pay Item No.	Description	Measurements
3.9.6	Excavation for Structure in Common Material including backfilling and disposal of surplus material	Cub meter / Per 100 cub. Ft
3.9.6	Excavation for Structure in Common Material Below Water Level including backfilling and disposal of surplus material	Cub meter / Per 100 cub. Ft
3.9.6	Excavation for Structure in Rock Material including backfilling and disposal of surplus material	Cub meter / Per 100 cub. Ft
	In Gravels whether above or below Water Level Rate Per CM / Per100Cft	Cub meter / Per 100 cub. Ft
	in Soft Rock whether above or below Water Level Rate Per CM / Per100Cft	Cub meter / Per 100 cub. Ft
	In Medium Rock whether above or below Water Level Rate Per CM / Per100Cft	Cub meter / Per 100 cub. Ft
	In Hard Rock whether above or below Water Level Rate Per CM / Per100Cft	Cub meter / Per 100 cub. Ft
3.9.6	Back filling behind abutments with borrowed coarse sand	Cub meter / Per 100 cub. Ft

3.9.7 Formation of Embankments

Description

This work shall consist of the formation of embankment including preparation of area for placing and compaction of embankment material in layers and in holes, pits and other depressions within the roadway area in accordance with these specifications and in conformity with the lines, grades, sections and dimensions shown on the Drawings or as directed by the Engineer

3.9.7.1 Material Requirements

Material for embankment such as common soil, gravel, soft or hard rock shall consist of suitable material obtained from structural excavation, roadway excavation or borrow excavation as approved by the Engineer. Borrow material however, shall only be used when there is no suitable material available from structural excavation or roadway excavation.

The material under this item shall conform to the following specification.

1. Contractor shall use AASHTO Class A-1, A-2, A-3, A-4 or A-5 soil as specified in AASHTO M-145 or other material approved by the Engineer.
2. CBR of the material shall not be less than five (5) percent, corresponding to the degree of compaction required for the corresponding layer.
3. Swell value of the material for embankment formation shall not exceed five tenth (0.5) percent. However, while establishing the swell value, surcharge weights representing the overburden will be used. In case sandy material is used for embankment formation, it shall be properly confined at no extra payment with a material and to the extent as approved by the Engineer and sandy material shall not be used on slopes of embankment.
4. In areas subject to flood and prolonged inundation of the embankment, such as at bridge sites, the material used in embankment, unless rock, shall be AASHTO Class A1 (a), A1 (b) and A-2-4, soils. Other soils may be used only with the written consent of Engineer.

3.9.7.2 Construction Requirements

3.9.7.2.1 Formation of Embankment with Common Material

1. Material for embankment, obtained and approved as provided above, shall be placed in horizontal layers of uniform thickness and in conformity with the lines, grades sections and dimensions shown on the Drawings or as required by the Engineer. The layers of loose material other than rock shall be not more than 20 cm (8 inch) thick.
2. The material placed in all embankment layers and the material scarified to the designated depth shall be compacted to the density specified as below.

Depth below sub-grade level	Percent of maximum dry density as applicable AASHTO T-180 ²
0 to 30 cm (0 to 1 ft)	95
30 to 75 cm (1 ft to 2.5 ft)	93
over 75 cm (over 2.5 ft)	90

Table 6, Density Requirement According to AASHTO T-180 (Chapter 3)

3. In place density determinations of the compacted layers shall be made in accordance with AASHTO T-191 (Sand Cone Method) or other approved methods. For all soils, with the exception of rock fill materials, containing more than 10% oversize particles (retained on 19 mm (3/4-inch sieve), the in-place density thus obtained shall be adjusted to account for such oversize particles as directed by the Engineer. Subsequent layers shall not be placed and compacted unless the previous layer has been properly compacted to desired standards and accepted by the Engineer
4. Material for embankment at points inaccessible to normal compaction equipment shall be placed in horizontal layers of loose material not more than 15 centimeters (6”) thick and compacted to the densities specified above by the use of mechanical tampers, or other appropriate equipment.
5. The compaction of the embankment shall be carried out at the optimum moisture content consistent with the available compacting equipment. In forming the embankment, the Contractor shall take steps to ensure that the work can be drained free of rain water, and he shall make due allowance in the height and width of the work for swelling or shrinkage. Embankment material that does not contain sufficient moisture to obtain the required compaction shall be given additional moisture to attain the optimum moisture content by means of approved sprinklers and mixing. Material containing more than the amount of moisture necessary to obtain the required compaction may not, without written approval of the Engineer be incorporated in the embankment until it has been sufficiently dried out. The drying of wet material may be expedited by scarification and disking or other approved methods.
6. When materials of widely divergent characteristics, such as clay and chalk or sand, drawn from different source are to be used in the embankment, they shall be deposited in different layers (with individual layer of the same material) over the full width of the embankment to depths and sequence of material to be laid as approved by the Engineer. Lumps of clay or other similar material shall be broken down, and no accumulation of lumps or boulders in the embankment will be permitted. No surplus

² **NOTE:** - Method “B” or “D” of AASHTO-T-180 whichever is applicable may be adopted. In road sections constructed of uniformly graded sands, or gravel the compaction shall preferably be determined by “Relative Density Method”

material shall be permitted to be left at the toe of embankment or at the top of cut sections.

7. Side slopes shall be neatly trimmed off to the lines and grades shown on the Drawings or as directed by the Engineer and the finished work shall be left in a neat and acceptable condition. The Contractor shall be responsible for the stability of all embankments made by him and shall replace at his own expense any portions which in the opinion.
8. The Engineer have been displaced due to any cause whatsoever. The Contractor shall remain responsible for the stability of the embankment in the position fixed in the drawings till the work has been finally measured and the period of maintenance has not expired.

3.9.7.2.2 Formation of Embankment with rock material

Embankment formed of material consisting predominantly of rock fragment of such size that the material cannot be placed in layers of the thickness prescribed without crushing, pulverizing or further breaking down the pieces, such material may be placed in layers not exceeding in thickness than the approximate average size of the rocks except that no layer shall exceed eighty (80) centimeters of loose measurement and compacted by a vibratory roller with the minimum mass as shown in the following table:

Mass per meter width of vibrating roll (Kg/M)	Depth of Fill Layer (mm)	Number of Passes of the roller on each layer
2300 - 2900	400	5
2900 - 3600	500	5
2600 - 4300	600	5
4300 - 500	700	5
> 5000	800	5

Table 7, Compaction Requirement by Vibratory Roller (Chapter 3)

1. The material shall be carefully placed in layers, so that all larger stones will be well distributed and voids completely filled with smaller stones, clean small spells, shale, earth, sand, gravel, to form a solid mass. After placing rock material, surface shall be covered with a layer of fine material having thickness less than twenty (20) centimeters. Such fine. material shall be reserved from roadway excavation by the Contractor. Should such material be available but not reserved, Contractor will supply and place borrow material for forming smooth grade without extra payment.
2. Each layer shall be bladed or leveled with motor grader, bulldozer or similar equipment capable of shifting and forming the layer into a neat and orderly condition. No rock larger than eight (8) centimeters in any dimension shall be placed in the top fifteen (15) centimeters of embankment unless otherwise allowed by the Engineer.
3. Material for each layer should be consolidated with heavy weight vibratory roller until settlement as checked between two consecutive passes of roller is less than one (1) percent of the layer thickness. In evaluation of settlement, survey points should be established and rolling continued until difference of levels as checked after two consecutive passes is less than one (1) percent of the total layer thickness. More over initial rolling of overlaid fine material shall be done without watering to ensure their intrusion in voids of rock layer beneath. Watering shall be done when voids are properly filled.
4. Embankments, which are formed of material that contain rock but also contain sufficient compactable material other than rock or other hard material to make rolling feasible, shall be placed and compacted in the manner prescribed above and to the point when settlement is within above mentioned requirement. Compaction test will be

made whenever the Engineer determines they are feasible and necessary. Each layer must be approved by the Engineer before the next layer is placed.

5. When rock to be incorporated in fill is composed largely of weak or friable material, the rock shall be reduced to a maximum size not exceeding fifty (50) percent of the thickness of the layer being placed

3.9.7.2.3 Formation of Embankment on Steep Slopes and over pipes and structure

1. Where embankments are to be constructed on steep slope, hill sides or where new fill is to be placed and compacted against existing pavement or where embankment is to be built along one half the width at the time, the original slope of the hill side, of existing pavement or adjacent to half width of embankment shall be cut in steps of twenty (20) centimeters(8inches) depth. Benching shall be of sufficient width to permit operation of equipment possible during placing and compaction of material.
2. Cut material shall be incorporated with the new embankment material and compacted in horizontal layers. No extra payment will be allowed for such an operation.
3. Embankments over and around pipes, culverts, arches and bridges shall be made with the selected material and compacted in such a manner as to avoid undue strain upon the structure

3.9.7.2.4 Formation of Embankment on Existing roads

Before fill is placed and compacted on an existing carriageway, the existing embankment and or pavement may be leveled by cutting, rooting or scarifying by the approved mechanical means to a level to be determined by the Engineer. The earth, old asphalt or other material arising as a result of this operation will be declared by the Engineer, either suitable or unsuitable for use in the construction of embankment/sub base. In the first case it shall be used in the adjacent embankment as directed by the Engineer, and payment shall be made as per relative pay item. In the second case the material shall be disposed off as provided in section 3.9.3 and 3.9.6, payment shall be made as per the relevant item.

Scarified material removed from the existing road surface may be placed in the embankment in thin layers in strict compliance with the instructions of the Engineer. No. extra compensation shall be allowed for the storing and re-handling of such material.

3.9.7.2.5 Formation of Embankment in water logged areas

Where embankments are to be placed in water logged areas and which are inaccessible to heavy construction equipment, a special working platform shall be first established, consisting of a blanket of fill material placed on top of the soft layer. The material of the working table shall consist of normal or processed granular fill, obtained from borrow excavation. This material shall conform to the following specifications:

Sieve Description	% of weight passing through the mesh sieve, AASHTO T- 27
3 Inch (75 mm)	100

Table 8, Gradation (Chapter 3)

The remaining grading shall be such as to avoid intrusion into the working platform material of subgrade or natural ground surface material. For this, condition to be met it will be required that the ratio.

D₁₅ (Working Platform Material)

D₈₅/D₁₅ is less than 5.

D₈₅ (Natural Ground Material)

D₈₅ and D₁₅ mean the particle diameters corresponding to 85% and 15%, respectively, passing (by weight) in a grain size analysis.

Construction of this working table shall proceed from one edge of the soft area by using the fill as a ramp for further material transport.

The thickness of the working table as prescribed above shall be approximately 0.5 meter unless directed otherwise by the Engineer, and the width shall be that of the embankment. The placement and compaction of the working table shall be carried out by use of light equipment, as directed by the Engineer

3.9.7.2.6 Trial Section

Before starting the formation of the embankment, the Contractor shall construct a maximum of three trial sections of 200 meter (660 feet) each for each soil type proposed to be used for compaction as directed by the Engineer. The soil used in the trials shall be the same as those intended to be used for the formation of embankment and the compacting equipment shall be the same equipment that the contractor will use for the main work and that has been accepted by the Engineer.

The object of these trials will be to determine the optimum moisture content and the relationship between the number of passes of compacting equipment and density obtained for the soil types under trial and for the verification of the soil type itself. No separate payment will be made for this work, as it is a subsidiary obligation of the contractor under the relevant pay items of this section.

3.9.7.2.7 Excavation in Embankment for Structures

Unless otherwise specified in the Special Provisions, the Contractor may choose with the approval of the Engineer to make excavation for road structures, culverts, and pipe culverts after the embankment has been constructed. Any space remaining after the placing of such structures of culverts and deducting for specified bed or backfill, shall be filled with GRANULAR material approved by the Engineer and compacted as follows: -

1. Layers not more than 20 cm (8inches") in loose thickness shall be placed and compacted in succession, with mechanical tampers or tyres or tracks of motor driven equipment operated transversely to the roadway, to the densities specified in the relevant section. Moisture content shall be adjusted as directed by the Engineer.
2. The excavation in embankment and the placing of backfill for the purposes described above shall not constitute any claims for payment but shall be covered under the contract unit price paid for other works in which the operation is involved. Granular backfill when specified by the Engineer shall be paid under the relative pay item.

3.9.7.3 Miscellaneous Requirements

To avoid interference with the construction of bridge abutments and wing walls the contractor shall, at points to be determined by the Engineer suspend work on Embankment and/or in cuts forming the approaches to any such structure until such time as the construction of the latter is sufficiently advanced to permit the completion of the approaches without the risk of interference or damage to the bridge works. The cost of such suspension of work shall be included in the contract unit prices for embankment. In carrying embankments upto or over bridges, culverts or pipe drains, care shall be taken by the Contractor to have the embankments brought to equally on both sides and over the top of any such structure.

1. When as result of settlement, an embankment requires the addition of material upto 20 cm (8") in thickness to bring it up to the required grade level, the top of the embankment shall be thoroughly scarified before the additional material is placed, and no extra payment shall be made for the scarification.
2. The contractor shall be responsible for the stability of all embankments and shall replace any portions that in the opinion of the Engineer have been damaged or

displaced. Embankment material which may be lost or displaced as a result of natural causes such as storm, cloud-burst or as a result of unavoidable movement or settlement of the ground or foundation upon which the embankment is constructed shall be replaced by the contractor with acceptable material from excavation or borrow. No additional compensation will be allowed for the replacement.

3. During construction the roadway shall be kept in shape and drained at all times. When unsuitable material has been placed in the embankment by the contractor, he shall remove it without extra payment.

3.9.7.3 MEASUREMENT AND PAYMENT

Measurement

The quantities to be paid for shall be the number of cubic meters or 100 cubic ft. calculated on theoretical designed lines and grades and the ground levels as established under the relevant clause, compacted in place, accepted by the Engineer:

A. Formation of Embankment from Borrow Excavation

Measurement shall be made as under:

Formation from Borrow = A – B – C

Where

A = Total Embankment Quantity

B = Roadway Excavation Quantity

C = Structural Excavation Quantity

B. Formation from Structural Excavation

This quantity shall be the same as calculated for structural excavation irrespective of its haulage distance except that declared unsuitable by the Engineer.

C. Formation from Roadway Excavation

This quantity shall be the same as calculated for Roadway Excavation. The contractor will be supposed to use material from Roadway Excavation irrespective of haulage distance. However, if contractor, for his own convenience, uses the material from borrow, the payment will still be made under the respective item.

In the measurement of "Formation of Embankment on steep slopes" no allowance will be made for the benching or volume of material cut out from the hill side or from the first half width fill to accommodate the compacting equipment but will be calculated only on the net volume of fill placed against the original hill sides, the old embankment or the first half width fill.

Payment

A. Formation from Borrow Excavation

The quantity to be paid for shall be the number of cubic meters or 100 cft. placed in embankment, measured as provided above for material from borrow excavation and such a payment will be deemed to include cost of excavation, payment of royalty, levies and taxes of Local, Provincial and Federal Government, cost of free hauling including all lead and lift,

reflected in the Bid Schedule, spreading, watering, Rolling, labor, equipment, tools and incidental necessary to complete this item.

B. Formation from Structural Excavation.

The quantity to be paid for shall be the number of cubic meters 100 cft placed in embankment and measured as provided above for material from structural excavation and such payment will be deemed to include cost of excavation, hauling, dumping, spreading, watering, rolling, labor, equipment, tools and incidental necessary to complete this item.

C. Formation from Roadway Excavation

The quantity to be paid for shall be the number of cubic meters 100 cft placed in embankment and measured as provided above for material from roadway excavation and such payment will be deemed to include cost of excavation, hauling, dumping, spreading, watering, rolling, labor, equipment, tools and incidental necessary to complete this item.

Pay Item No	Description	Unit of Measurement
3.9.7 a.	Formation of Embankment from Roadway Excavation in Common Material	Cubic Feet (cft)
3.9.7 b.	Formation of Embankment from Roadway Excavation in Rock Material.	Cubic Feet (cft)
3.9.7 c.	Formation of Embankment from Borrow Excavation from Rock Excavation within free haul.	Cubic Feet (cft)
3.9.7 d.	Formation of Embankment from Borrow Excavation in Common Material.	Cubic Feet (cft)
3.9.7 e.	Formation of Embankment from Structural Excavation in Common Material	Cubic Feet (cft)
3.9.7 f.	Formation of Embankment from Structural Excavation in Rock Material	Cubic Feet (cft)

3.9.8 Demarcation of Road Alignment – Specifications

Except as otherwise provided herein, all excavations and embankments for road work shall be made to the alignments, grades and dimensions shown in the approved drawings or established by the Engineer-in-charge in writing and shall also be in complete conformity with the corresponding requirement set forth in the section, excavation and embankment (Earthwork General) Specifications.

1. Rock Cutting and Earthwork in Hill Roads

1. Before the work is started at any place, the proposed central line of the road or a line parallel to it shall be set out by theodolite.
2. Apex pegs shall be fixed in concrete. The position of apex pegs and tangent points shall be indicated by a white mark painted on the nearest parapet wall or rock. A bench mark shall be made on the nearest rock, away from the cutting in a prominent place and painted white so that it can be found at all times.
3. Level shall than be observed at every 25 feet along and at right angle to the central line and recorded. On each cross-section a permanent peg shall be fixed clear of the cutting and its position clearly indicated on the drawing. This peg shall be known as reference peg (R.P) as the measurement of the work depends entirely on it.

4. The contractor's concurrence to the correctness of levels shall also be obtained in writing. All work executed by him prior to this concurrence shall not be measured for payment.
5. On completion, the new profile shall be plotted on the sections which shall again be verified and signed by the contractor.
6. Pegs shall be supplied and fixed, and bench mark made by the contractor or at his expense by the department. The marking of the center line shall also be done by the contractor. Work done in excess of that indicated on the approved drawing shall not be paid for.

3.10 Earth Filling

Description

This work shall consist of filling earth in accordance with these specifications and in conformity with the level and dimensions shown on the Drawings or as directed by the Engineer In charge.

3.10.1 Material Requirements

Material for filling such as common soil, gravel, soft or hard rock shall consist of suitable material obtained from structural excavation, or borrow excavation as approved by the Engineer In charge. Borrow material however, shall only be used when there is no suitable material available from structural excavation.

3.10.2 Construction Requirements

Common Material

1. Material for filling obtained and approved as provided above, shall be placed in horizontal layers of uniform thickness and in conformity with the level and dimensions shown on the drawings or as required by the Engineer In charge. The layers of loose material other than rock shall be not more than 20 cm (8 inch) thick. The material placed in filling to the designated depth shall be compacted to 90% of maximum dry density as determined by AASHTO T-180*. Note. *Method "B" or "D" of AASHTO-T-180 whichever is applicable may be adopted.
2. In place density determinations of the compacted layers shall be made in accordance with AASHTO T191 (Sand Cone Method) or other approved methods. For all soils with the exception of rock fill materials, containing more than 10% oversize particles (retained on 19mm (3/4-inch sieve), the in-l-7*+place density thus obtained shall be adjusted to account for such oversize particles as directed by the Engineer In charge. Subsequent layers shall not be placed and compacted unless the previous layer has been properly compacted to desired standards and accepted by the Engineer In charge.
3. Material for filling at points inaccessible to normal compaction equipment shall be placed in horizontal layers of loose material not more than 18 centimeters (7") thick and compacted to the densities specified above by the use of mechanical tampers, or other appropriate equipment.
4. The compaction of the filling shall be carried out at the optimum moisture content consistent with the available compacting equipment. The contractor shall take steps to ensure that the work can be drained free of rain water, and he shall make due allowance in the height and width of the work for swelling or shrinkage. Punjab Communication and Works Department Standard Specifications for Building Construction Draft 2016
5. Filling material that does not contain sufficient moisture to obtain the required compaction shall be given additional moisture by means of approved sprinklers and mixing. Material containing more than the amount of moisture necessary to obtain the required compaction may not, without written approval of the Engineer In charge be incorporated in the filling until it has been sufficiently dried out.
6. When materials of widely divergent characteristics, such as clay and chalk or sand, drawn from different source are to be used in the filling, these shall be deposited in different layers (with individual layer of the same material) and sequence of material to be laid as approved by the Engineer In charge. Lumps of clay or other similar material shall be broken down, and no accumulation of lumps or boulders in the filling with be permitted.

3.10.2.1 Large Scale Leveling Work

- In case of large-scale levelling work involving both cutting and filling, an accurate site plan shall be prepared before the work is commenced by contractor for approval of the Engineer-in-Charge. The portions requiring cutting and filling shall then be divided into squares and corresponding squares into filling, which are complementary to the squares in cutting giving the same number.
- A table may be provided in the plan showing leads involved between the various complementary squares. This would form a lead chart for the work to be done.
- Before the work of levelling is commenced, the lead chart shall be checked in the presence of the contractor or his authorized representative, and his signatures shall be obtained on the same. This should form an integral part of the contract and should be duly signed by both the integral parties before commencement of the work.
- The payment for lead shall be based on lead chart prepared in the aforesaid manner.

3.10.2.2 Borrow Soil

Materials required for fill and embankment construction not available from excavations be imported from pre-determined borrow areas approved by the Engineer-in-Charge before the start of the work. Wherever feasible, the average lead should be worked out and stipulated in the tender. The borrow area shall be stripped carefully of topsoil, sod and other matter unsuitable for fill. Surface of borrow areas shall be left after completion in a reasonable smooth and even condition approved by Engineer-in-Charge-. The initial limits and levels of the area to be filled should be recorded and approved by Engineer-in-Charge-. The levels should be properly checked during the progress of work and on completion.

3.10.2.3 Excavation in Trenches and Refilling

1. General

This shall comprise excavation to any depth in trenches for pipes, cables etc. and returning the suitable excavated material to fill the trenches after pipes, cables etc. are laid and their joints tested and passed, and disposal of surplus excavated material.

2. Refilling

Filling in trenches shall be commenced soon after the joints of pipes, cables, conduits etc. have been tested and passed. The space all around the pipes, cables conduits etc. shall be cleared of all debris, brick bats etc. Where the trenches are excavated in hard/ soft soil, the filling shall be done with earth on the side and top of pipes unless otherwise approved in layers not exceeding 20cm in depth. Each layer shall be watered, rammed and consolidated. All clods and lumps of earth exceeding 8cm in any direction shall be broken or removed before the excavated earth is used for filling. In case of excavation trenches in ordinary/ hard rock, the filling up to a depth of 30cm above the crown of pipe, cable, conduits etc. shall be done with fine material like earth, moorum or pulverized/ decomposed rock according to the availability at site. The remaining filling shall be done with boulders of size not exceeding 15cm mixed with fine material like decomposed rock, moorum or earth as available to fill up the voids, watered, rammed and consolidated in layers not exceeding 30cm. Excavated material containing deleterious material, salt peter earth etc. shall not be used for filling. Ramming shall be done with iron rammers where feasible and with blunt ends of crow bars where rammers cannot be used. Special care shall be taken to ensure that no damage is caused to the pipes, Cables, Conduits etc. laid in the trenches.

i. Measurements

Trenches for pipes, cables, conduits etc. shall be measured in cubic feet and will be paid accordingly.

Where two or more categories of each work are involved due to different classification of soil within the same stage of trench depth or where the soil is soft loose or slushy requiring increase in the width of trench or sloping sides or shoring, trenches for pipes, cables, conduits, etc. shall be measured in cubic meters. Extra excavation, if any, on account of collar/ socket of pipes shall neither be measured nor paid for separately.

3.10.2.4 Site Clearance & Surface Dressing

The surface area of the ground to be occupied by all banks, spoils, borrow pits shall be cleared of all roots, grass, shrubs, brush, trees, fences and such other works as may either cause hindrance with the execution of works or may decay and form dangerous pockets.

Surface dressing before placement of fill and construction of embankment shall include cutting and filling up to a depth of 15cm and clearing of shrubs, rank vegetation, grass, brushwood, trees and saplings of girth up to 30cm measured at a height of one meter above the ground level and removal of rubbish and other excavated material up to a distance of 50 meters outside the periphery of the area under surface dressing. High portions of the ground shall be cut down and hollows and depressions filled up to the required level with the excavated earth so as to give an even, neat and tidy look.

Length and breadth of the dressed ground shall be measured correct to the nearest cm and the area worked out in square meters correct to two places of decimal.

3.10.3 Measurement

The quantities to be paid for shall be the number of cubic feet in the volume of filling compacted to desired densities in place, accepted by the engineer in charge made with material resulting from:

1. Borrow Area
2. Structural Excavation.

Material from Structural Excavation, which is placed in the Filling and accepted by the Engineer in charge will be paid for under pay item No. 3.10 as the case may be, and such payments will be deemed to include all costs in connection with this material in constructing the embankment.

3.10.4 Rate

The unit rate shall be full compensation for all costs of complying with the provisions of this section regarding filling, in accordance with Drawings and as directed in writing by the Engineer-in-charge.

3.11 Termite Control

3.11.1 Pre-Construction Treatment

The work shall consist of pre-construction termite treatment through treatment of soil beneath the building and around the foundation with termiticides in accordance to these specifications.

3.11.1.1 Materials

Chemicals: Any one of the following chemicals in water emulsion to achieve the percentage concentration specified against each chemical shall be used:

1. Chlorpyriphos emulsifiable concentrate of 20%
2. Lindal emulsifiable concentrate of 20%
3. Any other Approved quality chemical duly approved by Engineer in Charge.

Water: It shall conform to Chapter 2 of Book 1 (Specification for Engineering Material).

3.11.1.2 Treatment

Treatment of Foundation: Bottom surface and sides of the excavation shall be treated with the termiticide solution through uniform spray with power sprayer at the rate of 4-litre per m²/10.76 ft². The preparation of solution i.e. ratio of termiticide and water shall as recommend by the manufacturers of termiticide.

Treatment of Top Surface: The top surface of the sub-grade prepared for laying flooring shall be treated by spraying termiticide solution with power sprayer at the rate of 4 liter per sq./10.76 sq. Ft surface.

Outside Barrier: When the construction of the building is complete out parameter of the building shall be treated at the rate of 4 liters solution in a hole made with iron rod a foot apart.

Precautions:

1. Laying of lean concrete should start when the termiticide solution is absorbed by the soil and surface is quite dry.
2. Treatment shall not be carried out when it is raining or when the soil is wet with rain or sub-soil water.
3. Once formed, treated soil barrier should not be disturbed.

3.11.2 Measurement

The work shall be measured as surface area treated separately in the following stages:

1. **Foundation stage:** Treated surface area shall be worked out by multiplying the sectional perimeter of excavation made for foundation with the length of excavation.
2. **Floor area of the building.**
3. **Outside barrier:** External perimeter of the building multiplied by 5 ft.

3.11.3 Rate

3.11.3.1 Labor Rate

This shall include:

1. Preparation of solution of termicide and water.
2. Application of solution with power spray machine which also includes, operation charges of spray machine i.e. Hire charges POL lubricant and crew.
3. Drilling of hole for outside barrier.
4. Injection of termicide solution in the holes.
5. Tempting of earth after creation of outside barrier.

3.11.3.2 Composite Rate

It shall include the cost of termicide solution prepared from the termicide emulsions as mentioned in section 3.5.1.1 and labor rate as detailed in section 3.5.3.1.

3.11.4 Anti-Termite Treatment of Existing Buildings

This work consists of treatment of buildings to control subterranean termite attack in accordance to these specifications.

3.11.4.1 Materials

Termicides

It shall conform to Section 3.11.1.1 of these specifications.

Water

It shall conform to Section 1 of these specifications.

3.11.4.2 Treatment Requirement

1. Prior to the treatment a thorough inspection should be made of the infestation in the building. This would help to assess the extent to which termite is spread and its entry routs into the building. After studying the infestation of termites in the building, it is work to exterminate the termites located in the buildings. It should be done in thorough manner. Termite hid out such as, ceiling, behind wooden paneling, electric wooden battens, conducts, switch board and similar locations should be thoroughly searched.
2. To create a barrier between the termite in soil and building, the soil adjacent to building should be treated with termicide solution. The soil in contact with external wall of the building should be treated with termicide at the given applying rate of certified manual of manufacturer of the vertical surface of the sub-structure to the depth of not less than 450 mm. To facilitate this treatment a shallow channel should be excavated along and close to the wall face. Termicide solution should be directed towards the wall at 1.75 liter per running meter of the channel. Rodding with 12 mm diameter mild steel rod at 150 mm apart should be done int eh channel for uniform dispersion of termicide solution to 450 mm depth from the ground level. Termicide solution 0.5 liter per running mater should be used to back fill earth as it is refilled into the trench directing the spray towards the wall surface. In case there is a plinth protection around the building 12 mm dia holes should be drilled as close as possible to the plinth toe wall at intervals of 300 mm deep enough to reach the soil below and termicide solution pumped in to these holes to soak the soil below at the rate of 2.25 liter/linear meter.
3. The above mode of treatment is applied to masonry foundations. For RCC foundations, the soil (backfill earth) in contact with the column sides and plinth beams along the external perimeter of the building should be treated with Termicide solution at the rate of 7.5 liter/sq.metre of the vertical surface of the structure. To facilitate this treatment,

trenches should be excavated equal to the width of a shovel exposing the sides of the column and plinth beams up to a depth of 300 mm, or up to the bottom of the plinth beams, if this level is less than 300 mm. The Termicide solution should be sprayed on the backfill earth, as it is refilled into the trench, directing the spray against the concrete surface of the beam or column as the case may be. If there is a concrete or masonry apron around the building, approximately 12 mm diameter holes are drilled to the plinth wall about 2.5 feet apart, deep enough to reach the soil below and the chemical emulsion pumped into these holes to soak the soil below and the chemical emulsion pumped into these holes to soak the soil below at a rate of 2.25 liter/linear meter. 12 to 15 mm diameter hole shall be drilled at the junctions of floors and walls at 300 mm interval to depth of 1.5 to 3 feet to reach the soil underneath the floor.

4. Termicide solution should be injected in to the holes using power operated pressure pump at the rate 4 liter/hole. Holes should then be sealed with matching colored cement. The movement of termite through masonry walls should be restricted by drilling holes in the masonry walls at the plinth level. The holes should be drilled at a downward angle of 45 degree preferably on both side of plinth wall approximately at 300 mm intervals. The Termicide solution should be injected, holes to holes in the masonry using a pressure pump. The holes should also be drilled at critical points such as wall corners and the points where door and windows are erected. The Termicide solution should be injected to the holes till refusal or to maximum of 1 liter/hole. The treated holes then be sealed.
5. All existing woodwork in the building in contact with the floor and walls and which is invested by termite should be treated at the points of contact with adjoining masonry, with the Termicide solution. The holes of 6 mm diameter should be drilled downward angle 45 degree at the junction of woodwork and masonry. Termicide solution should be ejected into these holes up to a ½ liter per hole. The treated hole should then be sealed. If the wood work is not already painted/varnished two coats of termicide should be given on all surface and crevices adjoining the masonry. Cover of the electrical switch boxes should be removed and inside of such boxes should be treated with termiticides dist. Re fixing of switch boxes covers should be done after termite treatment of switch boxes.

3.11.4.3 Measurement

It shall be measured as plinth area of the building treated. Its unit shall be Sft.

3.11.4.4 Rate

The rate shall include for full compensation for the cost of the termicide drilling, pumping/injection of termiticides sealing the treated holes with cement sand slurry of matching color, cleaning the floor to the satisfaction of Engineer-in-charges.

3.12 Earthwork by Mechanical Means

Earth work by mechanical means involves careful planning keeping in view site conditions i.e. type of soil, nature of excavation, distances through which excavated soil is to be transported and working space available for employing these machines. The earth moving equipment should be accordingly selected. The contractor shall submit for approval of the Engineer-in-Charge his detailed Method statement for carrying out the work. The approval of Method statement by the Engineer in- Charge shall not relieve the contractor for carrying out the work according to Contract Agreement as approved by the Engineer-in-Charge. The earth moving equipment consists of excavating and transporting equipment. Excavating equipment's may be further classified as excavators and tractor-based equipment's. The major items which may be used in Construction are listed below.

3.12.1 Excavators

Excavators generally used at site are as follows: -

1. Dipper shovel

It is used for excavating against a face or bank consisting of open-top bucket or dipper with a bottom opening door, fixed to an arm or dipper stick which slides and pivots on the jib of the crane. It is suitable for excavating all clay chalk and friable materials and for handling rock and stone. However, it is not suitable for surface excavation for which a skimmer is used.

2. Backhoe

It is similar to face shovel except that the dipper stick pivots on the end of the jib and the dipper or bucket works towards the chassis and normally has no bottom door but is emptied by swinging away from the chassis to invert the bucket. It may be designed to carry both a front mounted bucket and a rear mounted backhoe. It is mainly used to excavate trenches and occasionally used for the excavation of open areas such as small basements. In the backhoe mode the bucket lifts, swings and discharges materials while the undercarriage is stationary. When used in the 'loader' mode the machine loads or excavated through forward motion of the machine, and lifts, transports and discharges materials.

3. Skimmer

This arrangement is similar to the face shovel except that in this case the bucket slides on rollers directly along the jib and thus has a more restricted movement. It is used for surface excavation and levelling in conjunction with transport to haul away the excavated material.

4. Dragline

It is usually fitted with a long slender boom or jib and the bucket, which in operation faces towards the machine and has no door, is supported by cable only as on a crane. It works from the side of the excavation at normal ground level and is used for excavating large open excavations such as basements when the depth is beyond the limit of the boom of a backhoe. It is commonly used for open cast mining operations.

5. Clamshell

It comprises two hinged half-buckets or jaws pivoted to a frame which is suspended by cable from a long jib of an excavation. The grab is used for deep excavations of limited area on all types of soil except rock. Crane and Grab is a variant of this type of equipment.

3.12.2 Tractor Based Equipment

It is a self-propelled crawler or wheeled machine used to exert a push or pull force through mounted equipment. It is designed either as attachments to normal tracked or wheeled tractors or as machines in which the earth moving attachments and the tractor are designed as a single integrated unit. A tractor, which is hydraulically operated, can be rigged as: -

1. Loaders

It is used for loading, light dozing, scraping and grabbing operations, lifting and transporting the materials (loose earth, rubble, sand, gravel aggregate etc.) at various sites through forward motion of the machine.

2. Tractor Shovel

This consists of a tipping bucket at the front attached by strong pivoted arms or booms to the frame of the machine. It is used for stripping top soil, excavating against a face, bulldozing and for loading spoil or loose materials. It is similar to crawler dipper-shovel.

3. Trench Digger

It operates on the same principle as a backhoe excavator except that the bucket is controlled by hydraulic rams instead of cables and pulleys.

4. Scraper

Scrapers provide unique capability to excavate, load, haul and dump materials. Scrapers are available in various capacities by a number of manufacturers with options such as self – loading with elevators, twin engines or push-pull capability. They are cost effective where the haul distance is too long for bulldozers, yet too short for trucks. This distance typically ranges from 120 m. to 1200 m. however, the economics should be evaluated for each project. Scraper has an open bowl with a cutting edge positioned between the axles, which cuts, loads, transports, discharges and spreads through forward motion of the machine. Loading through forward motion of the machine can be assisted by a powered mechanism (elevator) fixed to the scraper bowl.

5. Bulldozer and Angle-dozer

The most common equipment used for clearing and levelling activities is a bulldozer. The term bulldozer is used to define a tractor mounted with a dozing blade. The bulldozer consists of a rectangular steel blade with renewable cutting edge set at right angles (capable of only tilting but not angling) to the direction of travel and attached by steel arms to the side frames of a crawler tractor. It may be used for excavating natural soil or for moving loose soil or debris, which is pushed forward as the tractor forces it ahead. Angle dozer is capable of both tilting and angling.

3.12.3 Transporting Equipment

This implies horizontal movement primarily but it can involve some vertical movement too.

1. Dumpers

These are self-propelled wheeled machines, having an open body. It is designed for the transport of excavated materials and consists of a shallow tipping hopper or skip mounted on a wheeled chassis, such as, power barrow, dumper, multi-skip dumpers, high discharge dumpers, dump truck, etc. These can be rear dump, side dump or bottom dump.

2. Trolley

It is designed for the transport of Construction material and are highly used for carrying materials and dust from place to place. These trolleys are of two types, Single wheel and Double wheel, and are easily available in Pakistan.

3. Cranes

Equipped with wire ropes, sheaves, and a hoist, cranes are used to lift and move materials and supplies during construction. Cranes are also useful for demolishing buildings and other structures. In construction, the two basic types of cranes are mobile and fixed.

a. Mobile cranes

Mobile cranes consist of trusses mounted onto mobile platforms, such as trucks or flatcars.

b. Fixed cranes

Are able to lift heavier loads and have better reach due to their increased stability. Tower cranes, used in high-rise building construction, are an example of a fixed crane mounted on top of a steel tower.

4. Trucks

Their high travel speeds allow for quicker transportation of materials when traveling on established roads. Their low hauling costs also allow for flexibility when determining the total hauling capacity or in the event of a change in destination/route.

a. Dump trucks

Used to move clay, dirt, soils, and sands. Side and rear dump trucks dispose of materials through the body attached to the chassis of the truck. Bottom dump trucks have two gates that open from the bottom to dispose of materials. For tougher terrain, articulated dump trucks are used.

b. Hauling trucks

Used to transport a fleet of equipment (for general, military, or service construction) from one location to another.

5. Vibratory Roller

It is a single Drum Vibratory Roller for compaction of embankments, etc. The smooth drum version is for compaction of granular and mixed soil. The sheep's foot Roller comprises a hollow cylindrical steel drum or drums on which projecting feet are mounted. These feet penetrate into the fill as a roller moves forward and cause compaction. The geometry of the foot may be sheep, club pyramid, cone or cylinder foot. Such rollers are employed for compaction (densification) of cohesive and semi-cohesive soils.

3.13 Excavation and Grading of Rocks

3.13.1 Excavation Methods

These Method relates to rock strength and fracture density.

3.13.1.1 Direct excavation

Direct excavation is possible in fractured rock and in all soils; using face shovel, backhoe, clam shell grab or dragline.

3.13.1.2 Ripping

Needed to break up slightly stronger rock, using tractor-mounted ripper, or breaking with boom-mounted hydraulic pick (pecker).

Where feasible, ripping will be preferred over blasting because it is considerably less expensive; ripping costs are typically 50 to 65% less than blasting. Ripping is also significantly less dangerous than blasting and requires fewer permits and special precautions. Ripping can be done in close proximity to populated areas or other places where blasting noise and vibrations are restricted. However, ripping is limited to soft to moderately firm, fractured rock and construction of low-angle cut slopes and shallow, near vertical cuts. In dense rock formations, light blasting is sometimes performed before ripping. Once the material is loosened by ripping, an excavator can be used to remove it and perform slope sculpting.

There are basically two types of rippers: the pull- (or tow-) type ripper and the integral bulldozer mounted ripper. In rock excavation, a bulldozer-mounted ripper works better than a pull-type ripper because it can exert greater downward pressure.

3.13.1.3 Breaking

Breaking is done with a hydraulic hammer (also known as a breaker or hoe ram), a percussion hammer fitted to an excavator that is typically used for demolishing concrete structures. It is used to break up rock in areas where blasting is prohibited due to environmental or other constraints. Like a ripper, a hydraulic hammer can be used in most rock types, although when sculpting a slope face, it works best in soft or moderately to highly fractured rock; existing discontinuities in the rock act as presplit lines, minimizing hammer induced scars and fractures while creating a slope face that appears to be naturally weathered. To allow for maximum downward pressure, the hammer is positioned perpendicular to the ground surface. Hammering locations are spaced evenly in a grid-like fashion so that the end rock product is fractured into pieces that can be loaded and hauled. For slope excavations, the hammering angle should be not be parallel to the major discontinuity orientation, as this may cause fractures into the final slope face.

3.13.1.4 Blasting

It is generally required in stronger, less fractured rock. Rock is loosened in the ground by undercharged blasting in some quarries: on urban sites can be broken by hand-held pneumatic drill or by pecker. Massive rock of moderate or high strength needs to be fractured normally by blasting; where blasting is unacceptable, breaking by pecker or hydraulic breaker is very slow.

3.13.1.5 Cut Slopes in Rock

- Sound rock can be cut to vertical faces; normally raked back by 10° and benched at 10 m intervals to improve safety.
- Inclined fractures are main hazard, notably dipping 30-70° Dips > 50° normally required cutting face back to clean bedding or fracture.
- Shale beds may weather and undercut slopes in strong sandstone or limestone.
- Hillside excavations may undercut unstable weathered rock, old landslides or soliflucted head.

3.13.1.6 Cut Slopes in Clay

- Drainage changes stability over time where face is cut into clay with initial water table near the surface.
- Excavation permits stress relief, pore water pressure (pwp) decreases.
- Pwp rises to regain equilibrium (drained state); strength and stability therefore decrease.
- Slope ultimately drains (or is artificially drained) to new lower water table; reduced pwp then increases stability.
- Premature failure occurs where stability is due to temporary pore water suction; failure may be in minutes or hours so faces are battered back for longer safety. Clay, unweathered, may cut to 65° slopes to 8 m high where small slips can be tolerated. Stiff glacial till may stand close to vertical for some months at less than critical height, so retaining walls can be built in front. Weep horizons on sand layers cause instability. Lateral stress relief in slopes cut in over consolidated clay may cause outward movement. Settlement adjacent to stable cut slope may be 1-2% of excavation depth.

Material	Cohesion	Critical Height, H	
		Un-fissured	Fissured
Soft Clay	25 KPa	5 m	3 m
Firm Clay	50 KPa	10 m	6 m
Stiff Clay	12 KPa	24 m	15 m

Values for typical fissured depth = z = 1.5 c/y

Table 9, Properties of Clay (Chapter 3)

Grade	Material/Rock Type and Name	U.C.S (unconfined compressive strength) MPa	Dry Density t/m ³	Field Properties of Rocks	Work Type
I	Coal	2-100	1.4	Crumble under blows break with hammer and hand	Pick work/ Jumper work
	Gypsum	20-30	2.2	Dent by finger nail white in color	Jumper Work.
	Salt	5-20	2.1	Show cubical cleavage ductile deformation in	Jumper Work.

				stress	
	Clay (Cretaceous)	1-4	1.8	Mold by finger, break by hammer if compacted.	Pick work.
II	Mudstone (Carboniferous)	10-50	2.3	Break by hammer crumble under pick blows. Break by hand.	Pick work/ Jumper work
	Shale (Carboniferous)	5-30	2.3		Pick work/ Jumper work
	Chalk (Carboniferous)	5-30	1.8		Jumper Work.
III	Limestone (carboniferous)	50-150	2.6	Moderately strong rock, break by hammer lime stone.	Jumper work/ Blasting work.
	Dolomite	50-150	2.5		
IV	Gneiss	50-200	2.7	Strong break by hammer	Jumper work/ Blasting work.
	Marble	60-200	2.6	Moderately strong rock, break by hammer.	
	Schist	20-100	2.7		
	Slate	20-250	2.7	Ripping needs to break.	
V	Sandstone (Greywacke)	100-200	2.6	Blasting generally required.	Blasting work/ Chiseling
	Conglomerate	variable	variable	Ripping & blasting required if cemented conglomerate.	Jumper work/ Blasting work.
	Weathered sandstone	5-40	1.9		
VI	Granite	50-350	2.7	Blasting, Chiseling and ripping required to break, very strong rocks. Mostly rocks are igneous and metamorphic.	Blasting work/ Chiseling
	Basalt	100-350	2.9		
	Quartzite	100-350	2.7		Blasting Work.

Table 10, Excavation and Strength Properties of Rocks (Chapter 3)

3.14 Horizontal Directional Drilling / HDD (Trenchless Excavation)

3.14.1 Description

Horizontal directional drilling (HDD) is a basic trenchless technology that involves drilling into the earth to create a horizontal bore under the surface along a planned pathway through which pipes and conduits may pass.

Directional Boring/HDD is generally accomplished in three principle phases. First, a small diameter pilot hole is drilled along a directional path from one surface point to another. Next, the bore created during pilot hole drilling is enlarged to a diameter that will facilitate installation of a pipeline. Lastly, the pipeline is pulled into the enlarge hole, thus creating a continuous segment of pipe underground and exposed only at the two initial end points.

3.14.2 Applications

Passing under roads, railways, engineering facilities, canals, rivers and others, overpassing existing underground communications during the construction of:

- gas and water pipelines, sewers and others
- casing pipes
- drainage lines
- cables with enough tensile strength

Material Requirement

Following Material and Equipment should be provided by the contractor:

- Pipes of approved type, Quality and Standards as mentioned in BOQ (PVC, Ductile Iron, HDPE etc.)
- Machinery for Drilling

3.14.3 Construction Requirement

3.14.3.1 Pilot Hole

Pilot hole directional control is achieved by using a non-rotating drill string with an asymmetrical leading edge. The asymmetry of the leading edge creates a steering bias while the non-rotating aspect of the drill string allows the steering bias to be held in a specific position while drilling. If a change in direction is required, the drill string is rolled so that the direction of bias is the same as the desired change in direction. The direction of bias is referred to as the tool face. Straight progress may be achieved by drilling with a series of offsetting tool face positions. The drill string may also be continually rotated where directional control is not required. Leading edge asymmetry can be accomplished by several methods. Typically, the leading edge will have an angular offset created by a bent sub or bent motor housing.

It is common in soft soils to achieve drilling progress by hydraulic cutting with a jet nozzle. In this case, the direction of flow from the nozzle can be offset from the central axis of the drill string thereby creating a steering bias. This may be accomplished by blocking selected nozzles on a standard roller cone bit or by custom fabricating a jet deflection bit. If hard spots

are encountered, the drill string may be rotated to drill without directional control until the hard spot has been penetrated.

3.14.3.1.1 Downhole Motors

Downhole mechanical cutting action required for harder soils is provided by downhole hydraulic motors. Downhole hydraulic motors, commonly referred to as mud motors, convert hydraulic energy from drilling mud pumped from the surface to mechanical energy at the bit. This allows for bit rotation without drill string rotation. There are two basic types of mud motors; positive displacement and turbine. Positive displacement motors are typically used in HDD applications. Basically, a positive displacement mud motor consists of a spiral-shaped stator containing a sinusoidal shaped rotor. Mud flow through the stator imparts rotation to the rotor which is in turn connected through a linkage to the bit. In some cases, a larger diameter wash pipe may be rotated concentrically over the non-rotating steerable drill string. This serves to prevent sticking of the steerable string and allows its tool face to be freely oriented. It also maintains the pilot hole if it becomes necessary to withdraw the steerable string.

3.14.3.1.2 Downhole Surveying

The actual path of the pilot hole is monitored during drilling by taking periodic readings of the inclination and azimuth of the leading edge. Readings are taken with an instrument, commonly referred to as a probe, inserted in a drill collar as close as possible to the drill bit. Transmission of downhole probe survey readings to the surface is generally accomplished through a wire running inside the drill string. These readings, in conjunction with measurements of the distance drilled since the last survey, are used to calculate the horizontal and vertical coordinates along the pilot hole relative to the initial entry point on the surface.

Azimuth readings are taken from the earth's magnetic field and are subject to interference from downhole tools, drill pipe, and magnetic fields created by adjacent structures. Therefore, the probe must be inserted in a non-magnetic collar and positioned in the string so that it is adequately isolated from downhole tools and drill pipe. The combination of bit, mud motor (if used), subs, survey probe, and non-magnetic collars is referred to as the Bottom Hole Assembly or BHA.

3.14.3.1.3 Surface Monitoring

The pilot hole path may also be tracked using a surface monitoring system. Surface monitoring systems determine the location of the probe downhole by taking measurements from a grid or point on the surface. An example of this is the TruTracker System. This system uses a surface coil of known location to induce a magnetic field. The probe senses its location relative to this induced magnetic field and communicates this information to the surface.

3.14.3.2 Pre-reaming and Ramming

1. Pre-reaming

Most contractors will opt to pre-ream a pilot hole before attempting to install pipe. For a pre-reaming pass, reamers attached to the drill string at the exit point are rotated and drawn to the drilling rig thus enlarging the pilot hole. Drill pipe is added behind the reamers as they progress

toward the drill rig. This insures that a string of pipe is always maintained in the drilled hole. It is also possible to ream away from the drill rig. In this case, reamers fitted into the drill string at the rig are rotated and thrust away from it.

2. Reaming

Enlarging the pilot hole is accomplished using either pre-reaming passes prior to pipe installation or simultaneously during pipe installation. Reaming tools typically consist of a circular array of cutters and drilling fluid jets and are often custom made by contractors for a particular hole size or type of soil.

3.14.3.2.1 Drilling Mud

Drilling mud such as fluid bentonite clay should be injected into the bore during cutting and reaming to stabilize the hole and remove soil cuttings. Drilling mud can be made from clay or polymers. The primary clay for drilling mud should be sodium montmorillonite (bentonite). Properly ground and refined bentonite shall be added to fresh water to produce a "mud." This mud reduces drilling torque, and gives stability and support to the bored hole.

3.14.3.3 Pull Back

Pipe installation is accomplished by attaching the prefabricated pipeline pull section behind a reaming assembly at the exit point and pulling the reaming assembly and pull section back to the drilling rig. This is undertaken after completion of pre-reaming or, for smaller diameter lines in soft soils, directly after completion of the pilot hole. A swivel is utilized to connect the pull section to the leading reaming assembly to minimize torsion transmitted to the pipe. The pull section is supported using some combination of roller stands, pipe handling equipment, or a flotation ditch to minimize tension and prevent damage to the pipe.

3.14.3.4 Buoyancy Control

Uplift forces resulting from the buoyancy of larger diameter lines can be very substantial. High pulling forces may be required to overcome drag resulting from buoyancy uplift. Therefore, contractors will often implement measures to control the buoyancy of pipe 30 inches or over in diameter. The most common method of controlling buoyancy is to fill the pipe with water as it enters the hole. This requires an internal fill line to discharge water at the leading edge of the pull section (after the breakover point). An airline may also be required to break the vacuum which may form at the leading edge as the pull section is pulled up to the rig. The amount of water placed in the pipe is controlled to provide the most advantageous distribution of buoyant forces. Some contractors may choose to establish a constant buoyancy. This can be accomplished by inserting a smaller diameter line into the pull section and filling the smaller line with water. The smaller line is sized to hold the volume of water required per lineal foot to offset the uplift forces.

3.14.3.5 Precautionary Measures

- Perform all operations in compliance with these guidelines and local laws and insure that all personnel are properly trained.
- Insure that the approved traffic control plan (required with the permit application) is implemented and followed at all times.
- Insure all setbacks, offsets, and clearances are maintained.

- Positively identify (by potholing) all crossed utilities that are expected to be:
 - above and within 5' of the proposed vertical alignment.
 - below and within 3' of the proposed vertical alignment.
 - and additionally, as directed by the Engineer in Charge.
- Positively identify (by potholing) all parallel utilities at the beginning and ending of all bores and
 - every 200' if it is within 5' of the proposed alignment,
 - every 50' if it is within 3' of the proposed alignment,
 - and additionally, as directed by the Engineer in charge.
- The HDD Contractor shall have a planned response in the event of a utility strike including utility owner notification and
 - avoiding electrocution in the event of an electric strike,
 - avoiding combustion in the event of a gas line strike,
 - avoiding contamination in the case of a sewer strike.
- Excess drilling fluid shall be confined in a containment pit at the entry and exit locations until recycled or removed from the site.
- Precautions shall be taken to ensure that drilling fluid does not enter roadways, streams, municipal storm or sanitary sewer lines, and/or any other drainage system or body of water.
- Drilling fluids that are not recycled and reused shall be removed from the site and disposed at an approved disposal site.
- The HDD Contractor shall calibrate its tracking and locating equipment at the beginning of each work day.
- The HDD Contractor shall complete the HDD installation as designed and permitted both horizontally and vertically unless otherwise authorized by the Engineer.
- The HDD Contractor shall plan its reaming and back pulling operations carefully to ensure that, once started, all reaming and back pulling operations can be completed without stopping and within the permitted work hours;
- The HDD Contractor shall inspect the work and surrounding area to ensure that no construction-related damage has occurred
 - including heaving or humping of paved surfaces, and
 - including drilling fluid fractures or releases
 - And if occurred such damage then contractor will be responsible for remedies.

3.14.4 Measurement and Payment

Measurement should be in unit mentioned in BOQ.

Payment should be made for whole operation of horizontal drilling along with the fixing of pipes. Site after work should be returned to its original form with in same payment.

3.15 Horticulture

3.15.1 General Requirements

3.15.1.1 Scope

Work covered under this section consists of furnishing all labour, equipment and material necessary to perform all operations required for landscaping inclusive but not limited to finished grading, supplying and spreading of soil and manures, turfing, planting/seeding/grass for lawns including supply and installation of tree guards, decorative stones, maintenance period, landscape, warranty, appliances and services necessary for and incidental to completing all the turfing operations and the associated works in a workmanship like manner, according to the provisions of the Contract.

3.15.1.2 Quality Assurance

The work must be undertaken by an experienced contractor specializing in turfing work and other specified activities. Work shall be performed and supervised at all times by qualified personnel. All materials shall be shipped with certificates of inspection as required by the Engineer-in-Charge. Manufacturer's certified analysis for standard packaged products shall be provided.

3.15.1.3 Submittals

- The Contractor shall submit catalogue data and literature of manufacturers and suppliers.
- The Contractor shall submit manufacturer's certified analysis of all standard products, including soil, fertilisers, peat, seed, inorganic and organic mulches.
- The Contractor shall submit a Performance Schedule for plantation of grass and carrying out other works within fourteen (14) days of the start of the Contract. This schedule shall identify the source of procurement of grass for plantation.
- The Contractor shall submit a weekly work schedule for approval before work is started. The schedule shall identify tasks to be completed on a weekly basis and the anticipated schedule for completing the tasks. The Contractor will then modify and submit the schedule on a weekly basis identifying tasks completed, tasks to be completed, problems encountered and recommendations.
- If ordered a soils report is to be submitted by the Contractor for all soils to be used for preparation of ground. The Contractor shall arrange for an approved independent analyst to prepare a physical and chemical analysis of the soil and irrigation water to be used. The analyst shall also provide recommendations on soil amendment, fertilizer application and the like. The report shall be submitted to the Engineer-in-Charge for approval before soil is placed. In the case of imported soil, the report shall be submitted at least 10 days prior to delivery. The report shall identify the source(s) from which imported soils are to be furnished. At a minimum, the soil shall be analyzed for:
 - a) Total salts (electro-conductivity of soil solution)
 - b) Soil pH
 - c) Exchangeable sodium, calcium, magnesium and potassium
 - d) Available phosphates
 - e) Organic matter as a percentage
 - f) Available zinc, manganese, iron and boron
 - g) Total sulphates

The soil analysis shall also include fertilizers and other amendment requirements and quantities which when incorporated with the soil will provide the required nutrient levels for vigorous plant growth. Additional soil samples shall be taken at the rate of one in every 20 loads or as directed by the Engineer-in-Charge and analyzed. The results will be compared with the original sample to ensure consistency and compatibility of supply. If specified, an operation and maintenance manual is to be provided by the Contractor. Instructions shall be furnished for year round care of plantation to be followed by the Owner. As a minimum, the manual will include the following: -

- Irrigation details: including water application rates and maintenance procedures
- Fertilization: including fertilizer descriptions, application rates and application schedule
- Salinity control: including leaching methods and leaching program monitoring.
- Pesticide/fungicide/herbicide applications: including safety application rates, procedures, and schedules.
- Turf grass management: including mowing procedures, a verification, topdressing, vertical mowing for thatch removal, rolling, over-seeding and springing.
- General maintenances: including pruning, stakes and ties, replacement and clean-up, protective fencing and grading.
- Equipment inventory: including maintenance procedures and manufacturer's maintenance manual.
- Landscape maintenance personnel requirements and job descriptions.

3.15.1.4 Job Conditions

The Contractor shall proceed with and complete grass planting operations as rapidly as possible as portions of the Site become available.

No planting shall be carried out during periods of heavy rain, sandstorms, heavy winds, or during intense daytime heat.

When special conditions warrant a variance to the planting time and conditions, a proposed planting schedule shall be submitted to the Engineer-in-Charge for review and approval. In such cases, the planting will be installed at no additional cost and all conditions and obligations such as maintenance and warranty remain the same.

3.15.2 Soil

Soil shall be sweet sand or washed marine sand free of admixtures of subsoil, foreign matter, toxic substances, weeds and any material or substance that may be harmful to plant growth. The Contractor shall furnish agricultural soil from approved sites. Material shall be stored in piles less than 1 meter high. Piles shall be protected from undue compaction and maintained free of contamination and construction debris. The soil shall comply with the following chemical criteria: -

- pH value: not less than 6.5 nor more than 8.5
- Electro-conductivity: less than 4 mm mhos/cm saturated extract at 25 °C
- Free carbonates: less than 0.5 % air dried.
- Chlorides: less than 200 ppm in saturated extract.
- Sulphates: less than 200 ppm in saturated extract.
- Exchangeable sodium: less than 15 % in neutral normal ammonium acetate.
- Boron: less than 1.5 ppm, hot water soluble. The soil shall comply with the grading criteria in Table-11 given below.

Sieve Size (mm)	% by Pass
5.000	100
2.380	65 to 100
1.180	45 to 100
0.600	35 to 80
0.300	5 to 48
0.150	0 to 15
0.075	0 to 3

Table 11, Grading Criteria (Chapter 3)

3.15.2.1 Soil Conditioners & Fertilizer

Peat shall be used where specified. Peat shall be a natural product of sphagnum moss peat/peat humus derived from a fresh water site. Peat shall be shredded and granulated to pass through a 12 mm mesh screen and conditioned in storage piles for at least 6 months after excavation. The peat shall be free from sticks, stones, roots, and other objectionable matter. It shall have a pH value of not less than 4 and nor more than 7.5. The minimum organic content shall be 85% on a dry weight basis. Peat shall be delivered in undamaged commercial bales in air dry condition. Manure shall be the decomposed animal manure of fully fermented pre-dried cow or chicken manure with minimum nitrogen, phosphoric acid and potassium percentage of 2-2-2 and a pH value of 6.0 to 7.5. Sludge waste product may be used as a substitute subject to approval of the Engineer-in-Charge. Manure and sludge shall be free of stones, sticks and non-bio-degradable material. Fertilizer shall consist of an approved compound containing not less than

- 10% Nitrogen
- 15% Phosphoric Acid
- 10% Potash
- or similar approved compound

3.15.2.2 Planting Soil Ingredients

The planting soil in gradients shall consist of approved soil, peat, manure and other soil conditioners as specified. The ingredients shall be placed in sequence as specified to meet the requirements of grass to be planted.

3.15.3 Grass Plantation (Lawns)

3.15.3.1 Site Preparation for Planting Areas

i. General Requirements

The Contractor shall examine areas to receive grass plantation with requirements and conditions affecting performance of work in this Section. The Contractor shall not proceed with plant operations until unsatisfactory conditions are discussed with the Engineer-in-Charge and corrected.

The Contractor shall determine the location of above grade and underground utilities and perform work in a manner which will avoid damage to them. Damage to underground utilities shall be repaired at the Contractor's expense. When conditions detrimental to the growth of grass are encountered, such as rubble, adverse drainage or obstructions, the Contractor shall notify the Engineer-in-Charge prior to planting. The area shall be cleared of stones, pebbles, stubbles, grass roots and other injurious matters and clods shall be broken. The following pre-planting steps shall be required for building a lawn.

- Careful grading makes good drainage so that lawn won't puddle and develop spots that are water logged and soft, or hard and dry.
- Incorporating organic matter and other soil amendments which are needed for proper growth and easy maintenance.
- Blending of top soil with native soil is done to make a transitional layer between top soil and native soil as it avoids trapping roots in a shallow top soil basin in which they would be dependent on frequent feeding and very frequent watering. The Engineer-in-Charge shall verify that sub-grades are as specified.

ii. **Sub-Surface Grading**

- All perennial weeds shall be treated with an approved herbicide and the period of time recommended by the manufacturer shall be allowed to elapse prior to commencing grading operations.
- Grading operations shall occur when the sub-soil is reasonably dry and workable. Areas to be graded shall be graded to smooth flowing contours with all minor hollows and ridges removed. Rock projections and boulders shall be removed and disposed of at a location agreed with the Engineer-in-Charge.
- Non-cohesive, light subsoil shall be loosened with a 3-tine ripper to a depth of 300 mm at 600 mm centres. Stiff clay and other cohesive subsoil shall be loosened with a single tine ripper to a depth of 450 mm at 1 m centres.
- A minimum of 150 mm of approved soil in accordance with 29.2 shall be spread uniformly over the loosened area and incorporated into the sub-grade soil to obtain a uniform and well pulverised soil mix.
- The area shall be compacted to a minimum of 90 % of maximum dry density as determined in accordance with Test 13 of BS 1377.

iii. **Finished Grading**

- Grades shall be brought to the finished ground levels agreed with the Engineer-in-Charge to a tolerance of ± 25 mm. Finished ground levels shall be 30 mm below adjoining paving or kerbs after compaction and settlement. Grading shall be carried out in such a manner that even gradients are formed between the spot levels with a pleasant contour. No depressions shall remain which could collect standing water.
- Soil shall be placed in lifts not greater than 150 mm in thickness.
- The filled area shall be compacted to a minimum of 90% of maximum density as determined in accordance with Test 13 of BS 1377. The manure shall be spread uniformly for the specified thickness.

iv. **Scalping Old Lawns**

The old lawn contains noxious weed grasses as Bermuda grass and old sod shall be stripped off with flat back spade before building a new lawn. The existing sod shall not be dug into soil as clumps of buried sod.

v. **Making the lawn bed smooth**

A lawn bed shall be as smooth and flat as possible. However, it should have slight pitch, even in flattened garden. Figure on fall of 6 to 12 inches in 100 feet so that water can run off once the root has reached its saturation point.

3.15.3.2 Seeding A Prepared Lawn Bed

Divide the amount of seed necessary for the area into four equal portions, so that there are four approaches over the seed bed. Divide the seed bed half by running a string down the middle. Broadcast one quarter portion down each half, spreading it evenly and uniformly within each marked area. Then run the string across the middle of the lawn in the opposite directions and scatter the remaining two quarter portions on the two halves. Broadcast the seed on the prepared lawn bed while the air is quite. It shall be done with hand or mechanical seeder. After the seed is broadcast, rake it in lightly to ensure a thorough contact of seed with seed-bed soil. Very lightly brush up the seeded surface with a wire rake using light circular motion so that the seed is dispersed evenly. In case there are concentrated patches, swirl them out lightly into the surrounding area to make an even covering. At this stage, do the cross raking and mulching in flat soled shoes, tennis shoes, or barefooted.

In case of hot dry weather or drying winds, in the 30 days after sowing, apply a thin, moisture holding mulch, over the seed. After seeding and cross raking, put on a 1/8 to 1/16-inch layer of peat moss or screened sawdust that has been aged at last one year. Don't toss it upward so that it falls in piles.

Whatever the covering, roll it smooth with a light roller (empty) after you have applied it. If a peat moss covering is lumpy, chop up the lumps with the back side of a wire rake before rolling. For initial watering, use adequate length of hose to get all the way around the lawn without dragging across it and a hand sprinkler that throws out a through but gentle spray. An hour a day for 20 to 30 days of watering shall be needed when days are warm and windy, waters 2 to 3 times a day to keep the surface continuously wet and keep the top dark with moisture until all the grasses are up.

If seeds and mulch happen to wash off on to an adjoining paved area, don't attempt to blast them back into place with the spray as it may washout more seeds along the sides of the seedbed. After the first week, the little seeding will have gained enough stature to take a bending. It is possible at that time, to pull the weeds that come up with the seeds, lay a plank out across the seedbed and walk along it to pull the weeds. Mow the lawn first time, when the grass is about 2 inches high or when the blades of grass take on a noticeable curvature. Bent grasses that are to be cut at 1-inch height should never be allowed to grow much higher than 1 inch. It is important that the mower be sharp at all times.

3.15.3.3 Seeding on a Slope

Lawns can be planted successfully on the ground that slopes up to 15%. If the slope is steeper, a ground cover or a system of terraces would be more satisfactory. Prepare the seedbed as described in 3.15.2.2 with following special care; When racking the seed bed, rake across the slope, when rolling the seed bed, roll it up and down. Burlap or specially manufactured anti-erosion net spread over a newly seeded slope will keep moisture in the ground and prevent seed from washing away. If burlap is of a tight weave, remove it as soon as the grass begun to come up. Anti-erosion net or loose weave burlap can be left in place to vet. Sprinkler system can be used if the slope can be covered with burlap and holes are cut for the sprinklers head. Otherwise water the seedbed by hand, standing at the bottom of the top. Don't use sprinklers for at least two weeks and then run them slowly to avoid puddling or washout. If erosion is likely to be a problem, install a drain scraper across the top of the slope to carry water off to one side. Sodding with desired permanent grasses is a good solution where an immediate erosion hazard exists.

3.15.3.4 Sodding A Prepared Lawn Bed

i. Shipping and Delivery

Prior to shipping the grass to be planted shall be inspected, dug, and made ready for shipping in accordance with standard practices and procedures. The Engineer-in-Charge shall be notified of

the delivery schedule in advance so the grass may be inspected upon arrival at the Site. All unacceptable grass shall be removed from the Site immediately. The Engineer-in-Charge may request inspection at the source prior to delivery of grass to the Site. The Engineer-in-Charge reserves the right to reject any delivery that does not meet the quality requirements.

ii. Storage

Grass shall be installed as soon as possible after delivery to the Site. Grass shall be protected from exposure to wind and direct sunlight prior to installation. Grass not installed on the day of arrival shall be stored in shaded areas, protected from the wind and maintained and watered to good horticultural standards until planted. Care shall be taken to ensure that the grass does not dry out. Seed and fertilizers shall be kept in dry storage away from contaminants in areas as designated or approved by the Engineer-in-Charge. Soil, compost, fertilizers and other amendments shall be delivered to the Site and stored separately in approved locations and in a manner to avoid contamination and wetting until soil mixing operations commence.

iii. Procedure

Unroll the sod on prepared soil, lay the strips parallel with the strips staggered as in the brick layer running bond patterns. Press each successively laid strip snugly up against the one next to it. After the sod strips are all laid in this fashion, roll the sod with roller half filled with water to smooth out rough spots and bond the sod with soil. Now water a little more carefully than usual for a few days till the grass is set.

3.15.3.4 springing or planting grass roots

i. Grass Materials

Grass sprigs shall be provided as healthy living stems stolons or rhizomes with attached roots including two to three nodes. They shall be 5 to 15 mm long without adhering soil. The limitation of time between harvesting and planting of sprigs shall be 24 hours. Sprigs shall be obtained from heavy and dense turf, free from weeds. Sprigs that have been exposed to heat and excessive drying will be rejected. Sprigs shall be planted at 150 mm apart in both directions. Grass seed shall be the latest season's crop and shall be delivered in original sealed packages bearing the producer's guaranteed analysis for percentage of mixtures, purity, weed seed content, and inert material. Seed that has become wet, mouldy, or otherwise damaged will not be acceptable. On-site seeding shall be done in the presence of the Engineer. The seed mixture shall be sown at the rate of 35 g/m². Grass seed mixtures shall be listed by schedule with information as follows: -

- botanical name
- common name
- proportion by weight
- minimum percentage of pure seed
- minimum percentage of germination
- maximum percentage of weed seed

Turf shall be strongly rooted, not less than 2 years old, free of weeds and undesirable native grass. Only turf that is capable of vigorous growth and development when laid shall be used. Turf shall be of a uniform size in width and length. Broken pads or pads with uneven ends will not be acceptable.

ii. Grass Sowing

- The soil shall be suitably moistened and then the operation of planting grass shall be commenced. The grass shall be dibbled at 10 cm, 7.5 cm, 5 cm apart in any direction or other spacing as specified to a depth of 15 cm. Dead grass and weeded shall not be planted. The Contractor shall be responsible for watering and maintenance of levels and the lawn for 30 days or till the grass forms a thick lawn free from weeded and fit for mowing whichever is later. Generally planting in other direction at 15 cm, 10 cm, spacing is done in the case of large open spaces, at 7.5 cm spacing in residential lawn and at 5cm spacing for Tennis Court and sports ground lawn.
- During the maintenance period, any irregularities arising in ground levels due to watering or due to trampling by labour, or due to cattle straying thereon, shall be constantly made up to the proper levels with earth as available or brought from outside as necessary Constant watch shall be maintained to ensure that dead patches are replanted and weeds are removed.

3.15.4 Irrigation Water

3.15.4.1 Salt Contents

Irrigation water shall be provided by the Contractor from a source approved by the Engineer-in- Charge as being suitable for irrigation. Water shall be free from substances harmful to plant life. Water sources shall not exceed the following parameters: -

- pH: 6 to 7
- total dissolved solids: less than 1000 ppm

3.15.4.2 Capacity

Each soil type has its own water holding capacity. The larger the soil particles, the less will be its water holding capacity. Here is the capacity of 100 square feet of soil, 1 feet deep

- In Sand - 60 Gal. = 1" deep irrigation
- In Loam - 60 Gal. = 1-1/2" deep irrigation
- In Clay - 160 Gal. = 2-1/2" deep irrigation

Obviously, the lighter soil must be watered more frequently than the heavy soil in order to keep moisture in it. In good deep soil grass roots will go down to from 24 to 30 inches, depending upon the type of grass, its age (a lawn root system goes deepest during the first year or two), and how the soil is watered. The root depth is however limited if the top soil is under laid with a layer of soil that is impervious to water.

3.15.4.3 Rates of Water Loss

The average water loss in mild summer areas is about 1 inch of water each week. In the hot localities, especially when a dry wind is blowing, the weekly loss increases to 2 inches and more in a week.

3.15.4.4 How Deep Does the Water Go

In dry soil one inch of water will penetrate as follows: -

- In Sand - 12"
- In Loam - 6"
- In Clay - 4" to - 5"

Water does not move down through soil until each soil particle has its film of water. After each particle has its quota, the additional water is free to move on the external particle. How deep one inch of water will penetrate depends on the moisture in the soil when water is applied. For example, an open field with a clay soil that was completely dried out by the time of a rain, had to receive 10 inches of rain before it becomes wet to a depth of 3 feet. But an added inch of water would penetrate 3 feet and more if the first were saturated.

3.15.4.5 Intervals for Watering of Lawn

Alternate wetting and partial drying out of soil, encourage healthier plant growth and deeper rooting in hot summer areas. Normally the soils would need more than 1" deep irrigation every week depending upon the penetration, aeration and the wilting coefficient of soil. Deep watering once a week shall be preferable which is however practicable only in canal irrigated area. In other areas light irrigation is resorted every 2nd or 3rd day or daily sprinkling.

3.15.5 Lawn Maintenance During Plant Establishment Period

The Contractor shall be responsible for maintenance of lawn as specified. Maintenance shall consist of watering, fertilizing, weeding, mowing, trimming and other operations as required to establish a smooth acceptable lawn free of eroded or bare areas. If required, the Contractor shall apply maintenance fertilizer after the second mowing. Any additional fertilizer shall be added when grass is dry. After application of the fertilizer, the area shall be watered well.

The Contractor shall maintain lawns for not less than the period stated below and longer as required to establish an acceptable lawn. Seeded lawn areas shall be maintained through three (3) maintenance cuttings but not less than sixty (60) days after substantial completion.

Sprigged and turfed lawn areas shall be maintained through two (2) maintenance cuttings but not less than thirty (30) days after substantial completion.

3.15.6 Final Acceptance

Prior to the completion of the plant establishment period, a preliminary inspection shall be undertaken by the Engineer-in-Charge. The time for this inspection shall be established in writing. The plant establishment and warranty period will end with this inspection provided the grass is growing in healthy condition. The Contractor shall repair any damages and defective turf shall be replaced. Replaced plants will be of the same size and species as originally specified. A final inspection, if required, shall be undertaken by the Engineer-in-Charge to determine that the deficiencies noted in the preliminary inspection have been corrected. The time for this inspection shall be established in writing.

3.15.7 Decorative Boulders

The stone boulders for placement in lawns shall be of size and shape as specified. The stones shall be of quartzite from river gravel limestone, sandstone from quarry as approved by the Engineer-in-Charge. Stones shall be hard sound durable and free from weathering and defects and patches of loose or soft materials that may adversely affect strength and appearance. The stones shall be placed in lawn as specified. The procurement shall be on the basis of sample stones presented by Contractor and approved by the Engineer-in-Charge.

3.15.8 Tree Guards

3.15.8.1 General

Tree guard shall be as specified and approved by the Engineer-in-Charge.

3.15.8.2 Bitumen Drums Guards

Bitumen Drum shall be free of damage or any weathering. The drums shall be perforated as specified and painted with alternate lines of black/white enamel paint of an approved brand.

3.15.8.3 RCC Guards

RCC guards shall be of specified sizes and shape and produced complying with the requirements of Plain and Reinforced Concrete. The guards shall be given three inside and outside white washing coats the guards shall be cast to the length shown on drawings and shall have a smooth surface.

3.15.8.4 Solid Block Masonry Guards

Solid Block Masonry Blocky Guards for trees shall be of Block Masonry for the size and shape as specified with perforations as shown. The Block masonry shall comply with the provisions of Block Masonry. In general, the perforations shall be 33% of the surface area of guards. The foundation shall be of 1:2:4 Plain Concrete as shown in Drawings complying with the requirements of Plain & Reinforced Concrete.

3.15.8.5 Brick Masonry Guards

The Brick Masonry Guards for trees shall be of size and shape as shown on Drawings complying with provisions of chapter-7 Brickwork.

3.15.8.6 Steel Frame Tree Guard

Steel frame Tree Guard shall be of size and shape as specified made of ASTM-A36 steel sections. The members shall be framed by welding according to AWS Code as specified using AWS 7016/7018 electrodes. The tree guards shall be given two coats of enamel paint over a primer as specified in accordance with applicable provisions of Chapter-13 Surface Rendering.

3.15.8.7 G.I. Barbed Wire

GI barbed wire where specified shall be fixed as shown on Drawings. The work shall comply with applicable provisions of Iron Steel & Aluminum Works.

3.15.9 Measurement and Payment

3.15.9.1 Composite Rate

The measurement and payment for the items of the work of horticulture hereof shall be made corresponding to the applicable CSR item as provided in Contract Agreement and shall constitute full compensation, for procurements, transportations, performance in all respect and completion of work as specified including the site clearance as approved by the Engineer-in-Charge.

3.15.9.2 Labour Rate

The measurement and payment for the items of the work of horticulture hereof shall be made corresponding to applicable CSR item as provided in Contract Agreement and shall constitute full compensation for procurements transportations, performance in all respect and completion of work as specified including site clearance, as approved by the Engineer-in-Charge except

the cost of materials to be provided by Department at designated location as defined in the Contract Agreement.

Annexure – A

Definition of Soils

Soils can be considered a three-phase system of solids, liquids, and gases. The solid phase consists of mineral and organic particles separated by a network of pores, some filled with gases-air with its carbon dioxide and oxygen being most important-and others filled with water. The proportions of each phase vary with the type of soil and are further modified by time, environment, and human, plant, and animal activities.

Genesis of Soils

The lithosphere, the solidified crust of the earth, currently is exposed over a quarter of the surface of the earth, with the remaining three quarters covered by water or ice. Oxygen, silicon, aluminum, calcium, sodium, potassium, and magnesium are the most abundant elements in the crust, accounting for about 90 percent of the lithosphere, although over 80 elements combined into 2000 compounds are present, the rocky crust, the parent rock for soil formation, is slowly fragmented into smaller pieces and into individual minerals by the action of wind, water, ice, and temperature changes. These fragments are altered by mechanical and chemical processes, mixed with organic materials, and changed by biological processes to form the extremely variable substance we can call soil. Rates of soil formation from rock vary not only with the nature of the parent rock, but also with time. Many soils are, on a geological scale, very young and are still being developed. Depending on climatic conditions, the nature of the parent rocks, and a host of biotic factors. Soil formation may be measured in eons, in centuries, or in decades. The establishment of a new home garden can be an example of soil formation within a few years. The type of parent rock is of major importance in the type of soils developed in a particular location. Sedimentary rocks produce soils that tend to be neutral or slightly alkaline, while soils formed above igneous granites are usually more acidic.

Physical Properties

Texture

Many of the horticultural characteristics of soils depend upon the relative size of the mineral particles, termed texture; Texture is determined by the proportions of sand, silt, and clay that make up the soil. Sand is composed of compounds of silicon, primarily silicon oxides or quartz, Sand particles are comparatively large with a low surface-to-volume ratio. Because particles may be large and irregularly shaped, there can be a large volume of space between the grains. Water enters easily, but passes out just as easily, so sand has little water-holding capacity. The large space between particles also means that sand has low cohesiveness. Sand tends to hold low amounts of plant nutrients. Silt is chemically heterogeneous, composed of particles of whatever the parent rock was. Being smaller in particle size than sand, water-holding capacity is higher because the space between the individual particles is smaller. Silts have moderate to high levels of nutrients with low to moderate cohesiveness. Clay particles are very small, with a high surface-to-volume ratio. Water-holding capacity is high, space between the particles may be almost nonexistent, and there is great cohesiveness of the particles. Many clays are composed of aluminum compounds, although other minerals are involved. Clays may be rich in nutrients. The minerals bound to clay may not always be available to plants because they may be tightly bound by electrostatic charges to the surface of the particles. Clays are separated into two major groups, those that swell when wet (and shrink

when dry) and those that rarely swell. Swelling clays are usually composed of finer particles that play important roles in nutrient retention and soil cohesiveness.

Particle Name	Diameter (mm)	Particles per gram	Surface Area (cm ² /g)
Boulder	Over 250		
Cobble	250-60		
Pebble	60-4		
Gravel	4-2		
Fine Gravel	2-1	100	10
Coarse Sand	1.0-0.5	700	25
Medium Sand	0.50 -0.25	6000	50
Fine Sand	0.25 –0.1	50000	100
Very Fine Sand	0.1 – 0.05	700,000	200
Silt	0.05 – 0.002	6,000,000	500
Clay	Less than 0.002	90,000,000,000	8,000,000

Table 12, Size Classification of Mineral Soil Particles According to the U.S. Department of Agricultural systems (Chapter 3)

Few soils are composed of only one particle type, but are mixtures at all three plus organic matter. Several methods are available for determining the ratios among particle groups and when the proportions are plotted on a textural triangle, mineral soils can be classified in horticultural terms. Textural analyses refer to the soils in the upper meter (39 in.) of the soil, that region in which most plant roots grow. Horticultural soils can also be classified simply by their feel. A handful of soil is mixed with water to the consistency of putty and squeezed into a ribbon between thumb and fingers. The ribbon that forms is related primarily to the clay content of the soil. If clay makes up more than 45 to 50 percent of the soil, the ribbon will be long and flexible due to the high cohesiveness of clay. Failure to form a ribbon indicates a soil with a high proportion of silt, and a gritty feel suggests that the sand content is high. Ribbons that start to form but then break are indicative of silty loams.

The formal designation of soil textures indicates the coarseness or fineness of soils, but not whether they are, in common terminology, heavy or light. These terms refer more to the ease of working or tilling soils than to texture, although heavy soils are almost always high in clay (when they aren't excessively stony).

Pore space is usually determined by measuring the bulk density of the soil. Commonly expressed as the weight of oven-dry soil divided by the volume of oven-dry soil, or grams per cubic centimeter (g/cm³), soils with low bulk densities have large pore space volumes. A good horticultural soil will have a bulk density of 1.0 to 1.5 g/cm³ and a pore space fraction of 0.4 to 0.6 (i.e., close to one-half of the total soil volume is pore space). The bulk density of heavy clay soils ranges from 1.0 to 3.0 g/cm³ and tillable silty loams range from 1.6 to 1.9 g/cm³.

Water Relations

From a plant's point of view, the soil in which it grows provides anchorage for its roots, a supply of air, and is the source of water and nutrients. The role of nutrients and of water in plant development is discussed later, but it is useful here to examine some of the water relations of soils. Water can exist in soils in all three physical phases, solid (ice), liquid, and vapor. Ice plays an important role in fragmenting rocks during soil genesis, and liquid and gaseous water are both involved in water retention, water movement through soil, and water uptake by plants. It should be remembered that soil water always contains dissolved minerals and gases. This soil solution is taken up by plants and is the source of minerals required by plants.

Chemical Properties

Water, H₂O or HOH, dissociates into two electrically charged particles or ions, one hydrogen ion (H⁺) and one hydroxide ion (OH⁻). In pure water the number of ions is very small relative to the number of un-dissociated molecules. One water molecule in over 500 million is dissociated; 1.0

mole of pure water (18 g) contains only 0.000001 moles of each ion, a number conveniently expressed as an exponential, 1 x 10⁻⁷. Because of the difficulty of dealing with extremely small numbers, the concentration or activity of the hydrogen ions is given on a pH scale defined as:

$$\text{pH} = -\log [W]$$

For pure water, the pH can be calculated as follows: -

$$\text{pH} = \log (1/0.0000001) = \log 10,000,000 = 7$$

Since a log scale is used, a full unit change in pH is a 10-fold change in the concentration of a hydrogen ion (Table 3, Hydrogen Ion Concentration and pH).

Water in soils is not pure, but contains many inorganic and organic chemicals that supply hydrogen or hydroxide ions which contribute to the total concentration of these ions in solution. The addition of hydrochloric acid (H⁺Cl⁻), for example, supplies additional hydrogen ions; the pH of the solution decreases as the concentration of H⁺ increases. When an alkali such as sodium hydroxide (Na⁺OH⁻) is added, some of the OH⁻ combines with H⁺ present in the solution to form water, and the pH increases as the number of H⁺ ions decreases. Soils at pH 7 are neutral in reaction (having an equal number of H⁺ and OH⁻ ions) soils with pH values below 7 are acidic and those with pH values above are alkaline. In plant science, soils with H values from pH 6.5 to 7.5 are considered neutral. Acid soil range from pH 6.5 to 4.0 and alkaline soils from 7.5 to 8.5. Soils with values below 3.5 or above 8.5 very rarely show good productivity. The pH reaction of soils depends on many factors. Soils in areas of high rainfall tend to be more acidic than those of dry areas because alkaline components-sodium, potassium, calcium, and magnesium-are relatively easily leached. Soils with a high aluminum content or those formed from granitic parent rock are acidic, while those formed from limestone with a high calcium component are alkaline.

H ⁺ (moles/l)	pH	Soil Reaction	Substance With given pH	Soil types
10	0		Battery acid	
10 ⁻¹	1			
10 ⁻²	2		Vinegar	
10 ⁻³	3	Acid toxicity	Lemon juice	Acidic peats
10 ⁻⁴	4	Very acidic	Orange juice	
10 ⁻⁵	5	Strongly acidic	Boric acid	Rainy region
10 ⁻⁶	6	Mildly acidic	Milk	Agriculture Horticulture
10 ⁻⁷	7	Neutral	Pure water	
10 ⁻⁸	8	Mildly alkaline	Sea water	
10 ⁻⁹	9	Strongly alkaline	Laundry soap	Arid region
10 ⁻¹⁰	10	Alkali toxicity	Laundry bleach	
10 ⁻¹¹	11			
10 ⁻¹²	12		Ammonia	
10 ⁻¹³	13		Lye solution	
10 ⁻¹⁴				

Table 13, Hydrogen Ion Concentration and pH (Chapter 3)

Group	pH range	Type	Optimum for Representative plants
Medacid	4.0-5.5	Very low calcium_ Swamplands	Orchids, beets, heath family, swamp and mountain plants
Subacid	5.5-6.0	Low calcium____ Abandoned fields, uplands	Cereal grains, maples, woodland flowers
Minacid	6.0-7.0	Moderate calcium____ Garden loams, meadowlands	Most vegetables and ornamentals, lawn grass
Circumneutral	6.5-8.0	High calcium____ semitropical	Most fruits and nuts trees, food and forage legumes, asparagus

Table 14, Horticulture Soils Grouped PH (Chapter 3)

Salinity and Sodicty

Independent of the chemical nature of the compounds involved, soils that- contain high concentrations of salts present problems to the grower. By definition, soils in which more than 15 percent of the total cation exchange sites are occupied by sodium ions are considered to be sodic (sometimes called alkali soils), and those in which the sites are occupied by other cations in sufficiently high concentrations to impair plant growth are considered to be saline. Saline soils may result from the accumulation of almost any ionic substance, although those in which the excess salts are from sodium, potassium, or lithium usually have the additional problem of disruption of soil structure by de-flocculation of soil colloids and loss of adequate pore space. Occasionally, soils are found which are both saline and sodic. Saline and sodic soils are found primarily in arid or semiarid regions where rainfall is limited and where extensive leaching does not occur. Even in regions with adequate precipitation, poor drainage conditions can lead to the accumulation of salts. Lands irrigated with water containing salts may, over a period of years, become saline or sodic. Soils near marine waters may become sodic as the fresh water is removed, allowing the infiltration of sea water.

Life in The Soil

So far, we have considered only the inorganic characteristics of soils, although we have mentioned how the presence of organic matter affects some of these characteristics. Many plants can grow satisfactorily under experimental conditions or in hydroponic culture in the complete absence of organic substance, but few plants do well in soils lacking organic matter. Microorganisms, plants, and animals all play roles in determining soil characteristics and productivity. For our purposes, we can separate organic soil constituents into two groups, those that are alive and those that are dead. The numbers of living organisms in soil are staggering. In a gram of a good horticultural soil, there may be over 2 billion bacteria, 400,000 fungi, 50,000 algae, and 30,000 invertebrates, plus roots and other plant parts. There are also uncountable numbers of virus particles. Soil organisms are not uniformly distributed since soils are themselves not homogeneous. They are concentrated in films on the surface of soil particles and congregate on fragments of decaying biotic debris. The species and numbers of soil organisms vary with the season and with environmental conditions; fewer are found during droughts and in the winter than in periods of optimum moisture and temperature. Changes in plant cover also affect the organisms in the soil. Conversion of a forest to an agricultural pasture results in alterations in the flora and fauna of the soils. Modifications of soils by fertilization, tilling, liming, and irrigation also alter the composition of the biota.

Organisms	Dry weight	
	Percent	Kg/ha
Bacteria	0.1-0.2	2,000-3,000
Fungi	0.1-0.2	2,000-3,000
Algae	0.0001-0.0005	5-10
Invertebrates	0.001-0.005	10-50
Vertebrates	0.0001-0.0005	1-5
Plants root	0.5-5.0	5,000-50,000
Organic matter	4.0-8.0	75,000-150,000

Table 15, Kinds & Amounts of Organisms & Organic Matter Typical of a Horticultural Loam Soil in the North Temperature Zone (Chapter 3)

	Percent Carbon(C)	Percent Nitrogen(N)	C:N ratio
Green cover crops			
Alfalfa	40	2.0	20:1
Clovers	40	3.0	13:1
Grasses	40	1.0	40:1
buckwheat	38	2.0	19:1
Mulches			
Peat moss	48	0.8	58:1
Fresh grass clippings	40	2.0	20:1
Dry leaves	40	1.0	40:1
Mixed mature compost	15	1.0	15:1
Straw	40	0.5	80:1
Sawdust	200	0.5	400:1
Rotted manures	30	1.5	20:1

Table 16, Carbon to Nitrogen Ratio of Common Mulching Materials (Chapter 3)

Acidification and Alkalization

Tolerance of plants to pH is fairly wide, ranging from about pH 4 (fairly acidic) to pH 8 (moderately alkaline). Many cultivated plants have a much narrower range. It is necessary to modify soil pH to ensure nutrient availability, reduction of metal toxicities, growth of desirable microorganisms, and conditions for increased crop productivity. The pH optimum for horticultural plants is species-dependent, but most will thrive at pH values between 5.5 and 7.0 and alteration of pH of soils within this range may not be necessary. Some alteration may be desirable to obtain the optimum for a specific crop, and alteration will be necessary for acid loving plants since their optimum values range from 4.0 to 5.5. Decisions on modifying soil pH should always be made on the basis of a soil analysis. Acidification of soils can be done by several methods. Organic materials that provide hydrogen ions, such as conifer needles, bark mulches. Sawdust mulches, cottonseed meal, oak leaves, and peat (sphagnum moss) are frequently used. Their acidifying potential is high and long lasting, but they are slow acting since they must break down before releasing hydrogen ions. Much quicker, but not as long lasting, are a variety of inorganic chemicals. Among the least expensive is elemental sulfur, also called flowers of sulfur. Its use in poorly drained or heavy soils is questionable since the sulfur may be converted by microorganisms into toxic compounds. Ammonium sulfate $[(NH_4)_2SO_4]$, ammonium nitrate (NH_4NO_3) , and ferrous sulfate $(FeSO_4)$ are used for small areas, and urea or liquid ammonia are used for agricultural lands. It is difficult to predict the effects of these chemicals and the amounts to be applied since soil depth organic matter content, cation exchange capacity, and other factors are involved soil tests are vital.

Many crop plants do best at pH values near neutrality. Soils that are subjected to leaching of basic cations or that have been cropped for many years may require upward adjustment of

pH. With few exceptions, lime is the substance of choice to reduce acidity. It is inexpensive, readily available, easy to handle, and very effective. Lime is a generic term covering ground limestone

or calcium carbonate (CaCO_3), slaked lime or calcium oxide (CaO), hydrated lime or calcium hydroxide [$\text{Ca}(\text{OH})_2$], and dolomitic. Limestone, which is a mixture of calcium carbonate and magnesium carbonate (MgCO_3). Other liming substances include marl, ground oyster shells, hardwood ash, basic slag, and egg shells. All of these acts. similarly, by increasing the base saturation level of the soil and converting the exchangeable hydrogen ions into water. In order to determine the amount to be applied, a soil test is conducted. The liming substances have different neutralization capacities based on weight, but similar capacities based on the calcium content.

Limestone has a more immediate effect if it is finely ground, although this increases the chance of its being blown away during and after spreading. A compromise grind of 90% capable of passing a 20 mm screen and 25 % passing a 0.15 mm screen is usually used. Coarser grind is also available and less expensive. Lime does not move horizontally in soils to any extent and its vertical movement is limited even when it has dissolved in soil water.

	Sulfur	Ferrous sulfate $\text{FeSO}_4 \cdot 7\text{H}_2\text{O}$	Aluminum sulfate $\text{Al}_2(\text{SO}_4)_3$	Ammonium nitrate NH_4NO_3
Solubility	Low	Moderate	High	High
Effect on pH	Slow	Moderate	High	High
Corrosivity	None	None	None	None
Effective time	long	Moderate	Moderate	Moderate

Table 17, Some Characteristic of Common Soil Acidifying Materials (Chapter 3)

Percent CaCO_3	Sound	Effervescence
0.1	None	None
0.5	Faint	None
1.0	Faint-Low	None
2.0	Distinct	Visible bubbles
3.0	Quite Distinct	Small bubbles
5.0	Very Distinct	Moderate bubbling
8.0	Very Distinct	Vigorous bubbling

Table 18, Field Estimation of Calcium Carbonate (CaCO_3) Content of Soil (Chapter 3)

To change upper 20cm		Sandy loam		Silty loam		Clay loam	
From pH	To pH	Lime²	Sulfur	Lime²	sulfur	Lime²	sulfur
4	5.6	250	--	400	--	500	--
5	6.5	170	--	280	--	325	--
6	6.5	70	--	110	--	120	--
7	6.5	--	5	--	8	--	15
8	6.5	--	60	--	75	--	100

Table 19, Amount of Acidifying Sulphur Or Alkalinizing Limestone needed To Alter Soil PH (Chapter 3)

Mulches and Composts

The optimum %age of organic matter in a productive soil varies somewhat with climate, soil type and the nature of the crop, but generally it is about 5 to 15 %. As soils are tilled as microorganism gradually utilized the humus and other organic matter, and as leaching or erosion occurs, the amount of the organic fraction decreases. Among the many consequences of this are

- Decreased soil porosity
- Disruption of soil aggregates and loss of granularity

- Decreased water-holding capacity
- Decreased aeration
- Increased erosion potential
- Increased water evaporation
- Decreased water buffering
- Increased leaching nutrients
- Alteration in favorable microorganism population
- Increased temperature variations

These changes are more rapid in soils of tropical areas where temperature and rainfall are high but occur fairly rapidly even in temperate zones. For good productivity organic matter should be replaced.

	Nutrients (as present of dry weight)			
	Nitrogen	Phosphorus	Potassium	Present dry weight
Cow manure	1.5	0.4	0.8	20-30
Horse manure	2.0	0.3	2	20-30
Sheep manure	4	0.6	3	25-40
Poultry manure	4	2	2	30-40
Bone meal	0.1	10	0	100
Dried blood	13	1	1	100
Hay and straw	2	0.3	2	90
Cottonseed meal	6	1	2	100
Peanut hulls	2	0.1	0.7	100
Dried kelp	0.6	0	1	100
Wood ash	0	2	6	100
Hardwood sawdust	0.2	0.1	0.2	100
Softwood sawdust	0.1	0.1	0.1	100

Table 20, Approximate Composition of Common Mulching Materials (Chapter 3)

Compounds	Present dry weight	
	Soil organic matter	Living plant tissue
Cellulose	30-60	2-8
Hemicelluloses	15-30	0-2
Lignins	15-30	30-50
Proteins	2-12	1-5
Fats and waxes	1-5	1-4

Table 21, Chemical Composition of Plant-Derived Soil Organic Matter Compared with The Plant Tissue (Chapter 3)

Soil Mixes for Homes and Greenhouses

Few house or greenhouse plants do well in soil dug out of the garden. Garden soils are usually too heavy and have variable composition. To standardize and control the substrate, potting mixes have been developed, some containing soils and some soilless. A variety of all-purpose and specialty mixes are commercially available, but for general use and volume production they are not cost efficient, and some contain sewage sludge contaminated with household and industrial waste. Potting mixes also called growing mixtures or soil mixes have advantages over top soil. They can be reproduced and are stable have excellent porosity, water holding capacity, cation exchange capacity and pest free. Because they are light in weight, large plants may topple or pulled from the pot, but the advantages outweigh the disadvantages.

Most potting mixes contain both plant-derived and inorganic materials with high water-holding capacity, resistance to compaction and high cation exchanges. Milled peat moss, leaf mold, shredded bark, humus, well-rotted manure, and wood chips are used. Inorganic constituents, such as sharp builder's sand, vermiculite, perlite, scoria (ground lava rock), and ground granite, improve drainage and increase pore volume. Small amounts of other substances are added to regulate pH and supply trace elements or nutrients.

Ingredient	Cornell peat-lite	University of California	John innes	Humus mix	Succulent and cacti mix	Epiphyte mix#1	Epiphyte mix#2	General house plant mix	Perennial container mix	Cornell seed starting mix	John innes seed compost	Rooting cutting mix#1	Root cutting mix#2	Coniferous bonsai mix
Major ingredient														
Sphagnum peat(shredded)	2	1	3	1	1	1	1	1	1	1	1	1	1	1
Sharp sand (0.5-1-0mm)		1	2	1	1			1	1		1	1	1	1
Bark (shredded)									1					
Leaf mould or humus				1	1	1	1	½	1					
Sandy loam soil			7				1	2			2	1		1
Vermiculite	1			1		1							1	
Perlite	1													
Additives														
Dolomitic lime(ground)	20	30	25			7	150	10	50	50	10			
20 presents superphosphate	50	50	50				50		75	25	10			25
Chelated iron	5	5					5		5	5				5
Fritted trace elememt	1								1					

Table 22, Potting Mixing For House Plants, Greenhose, And Garden Transplant Use (Chapter 3)

Annexure-B

Lawns

Contrary to expectations, lawn installation and maintenance are among the more expensive and time-consuming horticultural activities, the individual grass plants are not only subject to many pests and diseases, but also are deliberately crowded 'and in intense competition for space, light, water, and nutrients. Nevertheless, there is great personal desire and community pressure for a beautiful lawn to reduce dust and mud, to soften and enhance the landscape, and to sit and play on.

Situation	Hardiness zone	Hardiness zone
Sunny area	3-7	75% improved bluegrasses+25% improved red fescues
Shady area	3-7	75% improved red fescues+25% improved bluegrasses
Play area	4-8	80% improved tall fescues+20% perennial rye
Quick cover	3-9	75% annual rye+25% redtop
Rough lawn	3-8	33 1/3%ladino clover + 33 1/3% bluegrasses + 33 1/3 % tall fescues
Heavy traffic	4-8	60%fescues+ 20% bluegrasses +20% perennial rye
Over seeding	7-9	100% redtop

Table 23, Grass Seed Mixtures (Chapter 3)

Establishing a good lawn demands quality seed, appropriate to the particular soil and climatic conditions. Many grass species have been selected and bred for particular characteristics. Within these, named cultivars have been developed that are generally superior to the unimproved species. The named cultivars have the disadvantage of being almost isogenic (genetically uniform) To increase the lawn's survival under adverse conditions, most lawn grasses are sold as mixtures of two or more species. These mixtures are usually keyed to hardiness zones, to environmental conditions in various lawn climatic regions, and to the expected use of the lawn. In southern climates (Hardiness Zones 8 to 10) many lawns are established with a single species of grass, frequently as blends of several cultivars. Lawn grass seed should be labeled with the species and cultivars included, the germination percentage, the percentage weed seed (less than 1 percent is best), the percent of inert materials (less than 5 percent) and the percent of crop seed (less than 0.3 percent). Certified seed labels indicate that the plants were inspected in the field and were found to be true to type.

Sowing

Sowing seed into a well-prepared seed bed can be done by hand or with mechanical grass seeding machine. Since the seed is small, hand seeding, is made easier if the seed is thoroughly mixed with a carrier such as sand or topsoil. To ensure uniform distribution of seed, half the seed is sown in one direction and the other half at right angles to the first lot. After planting, the seed may be raked with a tooth rake to make sure that the seed is in direct contact with the ground. Rolling or treading the seeded area also ensures good contact. The seed should not be covered by more than 0.2 to 0.3 cm (1/8 in.) of soil for most cool-season grasses. Some varieties, such as the bluegrasses, germinate slowly, requiring over three weeks for full germination. Mulching the sown area conserves moisture, prevents the seed from being washed away by heavy rains, and prevents wide swings in temperature. A weed-free straw or hay cover is excellent when used at the rate of 100 kg/100 m² (100lb/100 ft²). On steep slopes or banks, cheesecloth, sacking, or one of the commercially available mulching cloths can be used. The grass blades will grow through the mulch which usually rots away within a few months. If the seedbed was properly prepared and adequately fertilized, additional fertilizer may not be needed for the first months of lawn growth. If fall planting was done, a light fertilization in spring when the grass begins to grow may be helpful, particularly if the plants are pale green or yellowish. A phosphorus deficiency is recognized as dark green plants with red stems and reduced growth. To avoid compaction of the soil, new lawns should not be walked on for the first month following appearance of the seedlings. Mowing can begin at this time with mower height set at 2 in. Chemical weed control is best deferred for another month or can be done the following spring.

Sodding

Sod is pre grown turf consisting of a weed-free mixture of grasses appropriate to the area. It should be purchased locally. Rectangles or strips of a mature turf 1 to 3 years old, are cut with special equipment to a thickness of 2 to 3 cm (1 in.), with little soil below the mat of roots. Laying sod is expensive, but it is an effective method on slopes subject to erosion or where a line, mature lawn is to be established in a short time. In many areas sodding provides an excellent turf, usually weed free, that is permanent with proper maintenance. In Hardiness Zones 4 to 8 sodding is most successful when done in the fall, although spring sodding may be done if adequate moisture and care are provided. In Hardiness Zones 8 to 10, where warm-season grasses are used, summer sodding is best. It is important that the sod is laid as soon as possible after delivery; a delay of even a few days will injure the turf since the root systems are exposed. Soil preparation is identical to that used for seedbeds except that the soil is graded 2 to 3 cm (1 in.) lower near walkways to adjust for the thickness of sod. The bed must be well prepared and leveled to allow firm and close contact between the sod; and the soil. Rectangles or strips are planted as tightly together as possible, much as flooring tiles are laid: To minimize trampling or compaction of the soil, a board is laid over the soil surface to be sodded. After the sod is installed, the area is top-dressed with a thin layer of good topsoil and topsoil worked into the cracks between the pieces of sodding. The new lawn is light tamped or rolled to ensure good soil-sod contact and is watered immediately. Should be watered frequently for the first growing season to prevent root damage and to encourage good root penetration. A light application of superphosphate will accelerate root penetration. Some grasses, particularly the warm-season species and the bent grasses, also be established from plugs or plantings (Table 14). Plug sodding utilize small rectangles or discs of sodded grasses with adhering soil. These are plant 15 to 30 cm (6 to 12 in.) apart in well-prepared bed.

Maintenance

If a fine, thrifty, weed-free lawn is desired, its maintenance becomes a significant part of management and cultivation. Unfortunately, lawns are neither work-free nor trouble-free. Fertilization, Liming, watering or irrigation, mowing, and control of animal and plant pests are the basic constituents of lawn management.

Fertilizing

If soil nutrients are brought to an adequate level during site preparation, additional fertilization will be unnecessary for the hulk of the first growing season. Indeed, over-fertilization is inadvisable since a young root system is less tolerant of high levels of inorganic salts than is the root system of an established lawn. Excessive nitrogen results in succulent, soft growth that is less disease and insect resistant.

Lawns should not be fertilized when the grass or the soil is wet. But it is good practice to water thoroughly after spreading fertilizer to wash any chemicals off the leaves, this prevents burning and ensures that the fertilizer reaches and enters the soil.

There is some confusion about the amount or rate of fertilizer application. While the phosphorus and potassium components in standard fertilizer formulations are necessary for grass development, lawn grass growth is primarily dependent upon the amount of nitrogen supplied, and it is the nitrogen component that is given primary consideration in determining fertilizer applications. For lawn applications, the amounts needed are usually given as pounds of nitrogen per thousand square feet or kilograms per hundred square meters, To provide 1 lb N/ 1000 ft² (1kg N/100 m²) using a 10-10-10 fertilizer, 10 lb (4 kg) of fertilizer would be used. Fertilizers may contain inorganic nitrogen as ammonium or nitrate ions, organically bound nitrogen, or a mixture of both, Inorganic nitrogen is immediately available to the plants, while organically bound forms release nitrogen slowly. When spring applications of fertilizer to cool season lawns or summer applications to warm-season lawns are made, the combination

formulations work well in spite of their high cost. For fall applications, where immediate uptake in cool weather is desired, only inorganic formulations are cost efficient. Fertilization schedules depend on the region and the grass type (figure 18-3). Warm-season grasses put on most of their growth during the hot summer months and should be fertilized at the time of maximum growth. Bermuda grass, St. Augustine grass, zoysia, or Bahia grass benefit from high fertilizer applications. Bermuda grass should receive 5 kg N/100 m² (5 lb N/1000 ft²), St. Augustine grass and the zoysias 2 kg N/100 m², and Bahia grass 3 kg N/100 m².

Liming

It should be obvious that correction of soil pH should be done only when it needs correcting as determined by a soil test. In general, established lawns on sandy soils require liming every two to three years, while those on clay soils need adjustment only every five to six years. The lime is usually supplied in a finely ground or granular form and can be spread at any time of the year, although late fall or very early spring are best. Amounts vary according to need, but are in the range of 10 to 30 kg/100 m² (10 to 30 lb/1000 ft²).

Watering

Watering or irrigation of lawns is, for most areas of North America, a necessity. An acre (0.4 ha) of lawn can transpire 2400 gallons (9600 liters) of water per day in midsummer. Considerable damage will occur if soils dry to their permanent wilting point (-15 bars) for any length of time. Many lawn grass roots grow to 30 cm (1 ft) or more into the subsoil and moisture levels at this depth should not fall below -8 bars during the period when the grasses are actively growing. It requires 2 to 5 cm (1 to 2 in.) of water to bring the upper 30 cm (12 in.) of a sandy or silty loam soil from near wilting point to field capacity. This amount of water will be transpired or lost by evaporation in a week under summer conditions. To replace this water, regular watering is required. In midsummer, when cool-season grasses stop growth and become summer-dormant, less water is needed. If it is desirable to maintain growth during this time watering must be continued at somewhat higher rates than the 2 to 5 cm per week. A light sprinkling of water several times a week is poor management practice. A good deal of this water is merely evaporated from leaf and soil surfaces and does not enter the soil at all. The water that does enter the soil remains in the upper few centimeters and the grass roots become concentrated in this superficial horizon. The danger of massive root kill by even light droughts or a short period of hot weather is great. Watering should provide the amount needed to bring the upper 30 cm (12 in.) to field capacity and should be repeated when this layer is still above the permanent wilting point—usually once a week or more frequently in very hot, dry weather with moderate to high winds.

Mowing

The fundamental rule on lawn mowing is to use only well-designed, well-maintained, and well-sharpened equipment. A dull blade, whether on a reel or a rotary mower, will shatter rather than cut grass blades cleanly and will increase the number of plants that die or become susceptible to infection. Although reel mowers involve more human effort, they are preferable to rotary mowers because they cut cleaner and are less dangerous to use. Cool-season grasses should not, except under special circumstances, be mowed closer than 5 cm (2 in.). Close mowing removes too much of the photosynthetic leaf blade tissue and depresses the growth of root systems. It also exposes previously shaded stems to direct sunlight which may result in sun scald. Cool-season grasses should be mowed at frequent intervals during the growing period. It is a good general rule that lawns should be mowed when the grass length has exceeded the recommended height by no more than 1.0 to 1.5 cm (1/2 in.) where mowing shock is minimal. The warm-season grasses are generally cut shorter than the cool-season grasses, Bermuda grass is maintained at heights of 1.5 to 2.0 cm (5/8 in.) and the others at 2.0 to 2.5 cm (3/4 to 1 in.).

Weeds

A bright green, well-trimmed, and weed-free lawn is not only an esthetic pleasure, but adds financial value to a property. Weed control is a necessary cultural practice for most areas. Close to 50 species of weed plants invade lawns and require control if clean turf is to be maintained (Figure 18-4). Weed control starts with the turf itself. A healthy lawn, provided with adequate fertilizer, water, and lime and properly mowed, resists the invasion of the seeds of many lawns particularly if the turf is mowed to at least 3.5 to 5.0 cm (1.5 to 2.0 in.), a cutting height that is also best for lawn development. Weedy species in lawns are separated into persistent (perennial) non persistent (annual) types and each type includes monocots and dicots. Two of the more troublesome weedy plants are the crabgrass and the nimble-wills. Both are monocots related to the lawn grasses. The crab-grasses are annuals, and nimble-will is a persistent perennial. The crab-grasses are vigorous C4.

Photosynthetic plants and are particularly difficult to eliminate once they have become established. Other grass species that are problems for lawns are the creeping bent-grasses foxtails, Dallis-grass and quack grass. Since the desired lawn grasses are usually as sensitive to herbicides as are the weedy species, special control measures are required in an established lawn. When lawns contain few weeds, hand removal is the least damaging method of control. Removal is best done after a rain or thorough irrigation since many weeds have relatively superficial root systems and it is easier to pluck out the entire plant when the soil is damp. Many weeds reproduce easily from rootstocks and failure to remove the entire plant results in spread of the weed. This is particularly true for dandelion (*Taraxacum*), cinquefoil (*Potentilla canadensis*) and the plantains (*Plantago* spp.). Both pre-emergence and post emergence herbicides are used in any thorough weed control program. The pre-emergence herbicides inhibit weed seed germination and early seedling growth, but have virtually no effect beyond that stage. They are effective in treating established lawns to eliminate crab-grasses, goose-grass (*Eleusine indica*), and creeping bentgrass all of which are resistant to most other herbicides. They may also be effective against seedlings of broad-leaved weeds, although post emergence herbicides are usually used for these plants. Pre-emergence herbicides are available as granules that spread in early spring. They should not be used on new lawns since they can kill lawn grass seedlings.

The post emergence herbicides include 2, 4-dichlorophenoxyacetic acid (2, 4-D) and its derivatives plus a variety of other chemicals that interfere with a number of physiological activities including photosynthesis, respiration, and synthesis of various compounds. Many are available as spreadable granules or as liquid formulations used as sprays. With few exceptions, spray formulations are most effective against young plants: as many weeds age, their tolerance to herbicides increases.

Herbicides are human and animal toxins, and as with all chemicals, package directions should be followed exactly. They can injure or kill desirable plantings and should not be used in very hot weather where they volatilize or in wind conditions where they may be carried to other plantings. Spot applications can be made by tipping a stick with a paint brush or a piece of plastic foam and touching individual weeds with the herbicide. Although formulations of fertilizer plus herbicides are available for dual treatment of lawns, they are more expensive than purchasing and applying each separately, and the timing for optimum effectiveness of each may be different.

Pests and Diseases

Three insect types are responsible for most lawn problems. Those that suck sap include the chinchbugs, some aphids, and scale insects. Plants of Augustine grass in the south are particularly plagued by chinch bugs. The webworms, occasionally called tobacco crambids, are larvae of moths that damage by feeding on grass leaves and stems. Armyworms, the larval stage of another moth, are leaf feeders. By far the most serious pests are grubs, the larval hatchlings of the Japanese beetle, May June beetles, and the billbugs. Beetle grub damage

is evidenced by death of patches of grass in June through early August and by observations of white grubs directly beneath the sod. These insect feed on the roots of grass plants just below the sod level and can destroy a large lawn area within a week.

The sap sucking insects and leaf feeders are controlled with appropriate insecticide sprays, usually applied in midsummer in the south and a few earlier in more northerly climates. Grubs can be controlled by preventing through sound cultivation practices, trapping or killing adults, use of biological, control and soil treatments with appropriate pesticides.

Other animal pests rarely present major problems. Termites damage the roots of some grass species in the Ohio River basin, wireworms occasionally attack grass rhizomes near potato fields, ants are more of a nuisance. Land crabs dig holes in southern lawns and are controlled with a rotenone solution poured into each burrow. Mole burrows are unsightly and can result in uprooted plants. Moles feed on grubs, so that grub control almost invariably resolves the mole problem. No one has successfully dealt with neighborhood dogs, cats, and squirrels. A well-managed lawn is the best disease control. Among the worst management practices in terms of disease development is over-fertilization with high nitrogen formulations. Hot, wet summers are unavoidable, but they should alert the gardener that special care must be exercised if serious fungal diseases are to be avoided. Among the most common diseases of lawn grasses are the mildews, rusts, and smuts. Mildew infections look as if the grass had been dusted with a white powder and are controlled with fungicides. Rusts and smuts rarely kill thrifty, deep-rooted grass plants and can usually be controlled by fungicides; Smuts attack tender leaves forming black, powdery spore masses on curled leaves. In northern regions snow molds are a recurrent problem. The snow mold fungi attack overwintering leaves, and the results of their activity, dead circles or patches of grass, are seen when the snow melts. Unless the disease is far advanced, fungicidal treatments are effective.

Repair, Restoration and Renovation

Even with reasonable maintenance, lawn repair, restoration or renovation becomes necessary. Soil compaction in traveled areas, the growth of shade trees, diseases, and neglect can individually or collectively create problems that must be corrected. These operations should be distinguished from routine maintenance. Older lawns that show minor wear and tear can be repaired by relatively simple procedures. Chemical and hand removal of weeds is best done prior to mowing the lawn to 2.5 cm (1.0 in.). Clippings should not be added to a compost heap, but collected and discarded. Fertilization to correct nutrient deficiencies, liming as indicated by soil tests, and accelerated maintenance techniques should be included. Repair work can be done at any time of year, but spring and fall are best.

Much has been written about the horrors of thatch buildup as a factor in lawn decline and waste of it is probably overstated. The stolons of lawn grasses such as the bents and Bermuda grass are horizontal stems that extend along the ground and become intertwined. As stolons die, they can form a thick layer of organic material that decomposes slowly, sheds water, causes soils to dry out, and harbors earwigs and other pests. True thatch is a fluffy, matted blanket of these stolons above the soil.

Ground Covers

In many situations grass lawns are neither practical nor desirable. Heavily shaded areas including those on the north sides of structures, under mature trees, and behind hedges and tall fences rarely receive enough light to allow a good lawn to develop; Areas immediately adjacent to woodlots also rarely form good lawn. Steep banks are difficult to mow, are frequently dry and infertile, and rarely can be successfully seeded because of runoff and erosion, all of these situations are being handled by planting ground cover plants. These should not be considered as second choices or compromise plantings; many ground covers are handsome and colorful additions to the landscape. Contrasting textures, foliage colors,

and splashes of flower color add greatly to the total view of a garden. Most effective ground covers are herbaceous perennials or small woody shrubs. They may trail along the ground or spread by rhizomes so that bare areas are quickly covered. Some ground covers are essentially care-free, requiring only minimal fertilizing and watering, while others need as much or more attention as lawn grasses. Because of the large number of possible ground covers, selection is based not only on prevailing environmental conditions, but also on considerations of hardiness, foliage and flower interest, and the landscaping plan. Many low-growing perennial flowering plants can be used as ground covers, Baby's breath (*Gypsophila repens*) turfing daisy (*Matricaria tchihatchewe*), some saxifrages, lily of the valley (*Convallaria majolis*), and others can fill in shaded areas. For southern areas (Hardiness Zones 9 to 10), gopher apple (*Geobalanus* spp.), peperomia, creeping charley (*Pilea hummulariaefolia*) inch plant (*Zebrina pendula*), and several species of veronica are excellent shade-tolerant ground covers. Although not usually considered as ground covers, there are herbs to suit most conditions and locations. Included among those that are often used as ground covers are catnip, tarragon, mint, pennyroyal, burnet, germander, lovage

Latin Name	Common Name	SEEDS		Plugs or Plant		Mowing Height (in)	Remarks
		Time	Rate (lb/1000ft ²)	Time	Rate (lb/1000ft ²)		
Cool Season Grasses							
<i>Agropyron crictatium</i>	Crested Wheat grass	F	1-2	----	----	2	Dry, cool areas
<i>Agrostis canina</i>	Velvet bentgrass	F	1-2	----	----	1	Humid, cool areas
<i>A.gigantea</i>	Redtop	F	1-2	----	----	1.5	Quick cover, short-lived.
<i>A.stolonifera</i>	Creeping bentgrass	F	1-2	F	1000	1	Humid, cool areas
<i>A.tenuis</i>	Colonial bentgrass	F/s	1-2	----	----	1	Humid, cool areas, finest lawns
<i>Bouteloua grevilis</i>	Blue gramagrass	S	1-2	----	----	1.5	Dry, cool areas drought resistant
<i>Festuca rubre</i>	Red fescue	F	3-5	----	----	2	Dry, cool areas shade resistant
<i>F.ruba</i>	Fescue improved	F	2-4	----	----	2	Water resistant, shade tolerant
<i>F.ruba hetrophylla</i>	Chewing Fescue	F	3-5	----	----	1.5	Cool areas, shade resistant
<i>Lolium mulslorum</i>	Annual ryegrass	F/S	4-6	----	----	2	Quick cover, short lived.
<i>L.perenne</i>	Perennial ryegrass	F/S	3-5	----	----	1.5	Used in mixtures

							with other grasses.
Poa pratense	Common blue grass	F	2-3	----	----	2	Drought resistant, rough use
P. pratense	Bluegrass improved	F	1-2	F	1000	2	Most common component in mixtures.
Trifolium repens	White Clover	F/S	2-4	----	----	1.5	Cool areas, nitrogen fixing legume.
T.r. forma lodigense	Ladino clover	F/S	2-4	----	----	---	Dry areas, rough lawns
Warm season grasses							
Buchloe dactylsides	Buffalo grass	S	1-2	S	50	1.5	Drought resistant, rough use
Cynodon Dactylon	Bermuda grass	S	2-3	S/S	10	0.75	Southern areas, in acidic area
Emerochola optiroides	Centipede grass	S	2-3	S/S	10	1	Low maintenance invasive
Paspalum notaum	Bahia grass	S	2-3	--	---	1	Humid Warm areas, coarse textures
Stenotaphrum condatum	St. Augustine grass	--	---	S/S	30	1	Shade tolerant heat resistant
Zoysia Matrella	Japanese zoysia	S/S	1-2	S/S	30	1	Wear resistant, yellows in summer
Z.tenuifolia	Velvet Zoysia	S/S	1-2	S/S	30	1	Fine texture, yellows in summers

Table 24, Seeding of Planting of Lawn Areas (Chapter 3)

Latin name	Common name	Mature height(cm)	Light	Soil	Flowers	Hardiness zone
Acaena microphella	Sheepbur	0.5	FS	N	-	7
Achillea spp.	Yarrow	30	FS	N		3
Aegropodium spp.	Goutweed	35	FS	N	-	4
Ajuga repens	Bugleweed	20	FS	N	+	4
Akebia quinata	Akebia	VINE	SH	N	-	5

Aloe spp.	Aloe	10	FS	N	+	9
Andromeda polifolia	Bog roesmary	30	FS	Wet	+	3
Arabis alpine	Rock ress	20	FS	N	+	4
Arctostaphylos spp,	Bearberry	30	FS	Wet		3
Arenaria verna	sandwort	8	FS	N	+	3
Armeria maritima	Thrift	30	FS	Wet	-	3
Cerastium spp.	Snow in summer	20	SH	N	+	3
Chamaemelum nobile	Chamomile	15	FS	N	+	4
Convallaria majalis	Lily –of-thevalley	20	SH	N	+	3
Cornus Canadensis	Bunchberry	18	FS	Wet	+	3
Coronilla varia	Crown vetch	60	FS	N	+	4
Dichondra micrantha	Dichondra	8	SH	N	-	9
Duchesnea indica	Indian strawberry	5	SH	Wet	-	6
Erica carnae	Heath	25	FS	Acid	+	6
EUONYMUS FORTUNEI	Wintercreeper	15	FS	Wet	-	5
Fragaria chiloensis	Wild strawberry	12	FS		+	5
Galax urcreolate	Wandflower	15	SH		+	4
Gaultheria procumbens	Wintergreen	1	SH		+	4
Glechoma hederacea	Ground ivy	2	FS		-	4
Hadera helix	English ivy	Vine	SH		-	6
Juniperis cvs	Creeping juniper	35	FS		-	4
Liriope spicata	Lilyturf	20	FS		+	7
Mitchella repens	Partridgeberry	3	SH		+	4
Mazus reptans	Mazus	3	SH		+	4
Ophiopogon japonicas	Dwarf lilyturf	15	SH		+	6
Pachysandra spp.	Pachysandra	30	SH		-	5
Phlox subulata	Moss pink	15	FS		+	4
Phylanodiflora	Lippie	10	FS		-	6
Potentilla spp.	Cinquefoil	10	FS		+	5
Prunella vulgaris	Self-heal	5	FS		+	3
Sagina subulata	Pearlwort	10	FS		+	5
Sedum spp.	Stonecrop	10	FS		+	4
Teucrium chamaedrys	Germander	30	SH		+	6
Thymus spp.	Thyme	4	FS		+	4
Veronica spp.	Speedwell	10	FS		+	4
Vinca minor	Periwinkle	15	SH		+	5
Vtola spp.	violet	10	SH		+	3

Table 25, Some Ground Cover Plants (Chapter 3)

FS = full sun; Sh = partial shade; N = normal soil; wet=can withstand wet soil; acid= requires pH

Contents

CHAPTER – 4	DISMANTLING (DEMOLITION)	3
4.1	DEMOLITIONS AND PREPARATION OF SITE	3
4.1.1	SCREENS	3
4.1.2	DIVISION OF SERVICE	3
4.1.3	INVENTORY OF SERVICEABLE MATERIALS	3
4.1.4	DAMAGE	3
4.1.5	SEWERS AND DRAINS	3
4.1.6	SHORING OR UNDER-PINNING	3
4.1.7	LOWERING	3
4.1.8	MEASUREMENT SHOULD TAKE DURING DEMOLITION OF CERTAIN ELEMENTS	4
4.1.9	SHORTING STACKING & DISPOSAL	5
4.1.10	MEASUREMENT	6
4.1.11	RATE	6
4.2	UNDER – PINNING	6
4.2.1	LENGTHS	6
4.2.2	UNDERPINNING OF ADJOINING FOUNDATIONS	6
4.2.3	PLANKING AND STRUTTING	6
4.2.4	CUTTING OF PROJECTING FOUNDATION IN OLD WALLS ETC.	6
4.2.5	WEDGING	6
4.2.6	TEMPORARY SHUTTERING TO CONCRETE	7
4.2.7	TIMBERING, SHORING ETC.	7
4.2.8	MEASUREMENTS	7
4.2.9	RATE	7
4.3	SHORING	7
4.3.1	USE	7
4.3.2	REQUIREMENTS	7
4.3.3	RANKING SHORES	7
4.3.4	SOLE PIECES, NEEDLES, ETC.	8
4.3.5	WALL PIECE	8
4.3.6	FLYING SHORES	8
4.3.7	NEEDLE SHORING	8
4.3.8	MEASUREMENT AND RATES	9
4.4	WASTE HANDLING	9
4.4.1	CHUTES	9
4.4.2	DEBRIS RECYCLING	9
4.4.3	DUST MINIMIZATION	10
4.4.4	DEBRIS ACCUMULATION	10
4.4.5	DEBRIS DISPOSAL AND MANAGEMENT SYSTEM	10
4.4.6	DEBRIS LOADING	11
4.4.7	WASTE MANAGEMENT	11
4.5	DEMOLITION BY MECHANICAL MEANS	11
4.5.1	WRECKING BALL	11
4.5.2	DEMOLITION BY PUSHER ARM	12
4.5.3	HYDRAULIC CRUSHER WITH LONG BOOM ARM	13
4.5.4	DEMOLITION BY WIRE ROPE PULLING	14
4.5.5	MECHANICAL METHOD BY CLAM SHELL	14
4.5.6	JACK HAMMER	14
4.6	OTHER METHODS	15
4.6.1	NON-EXPLOSIVE DEMOLITION AGENT	15

4.6.2	SAW CUTTING	15
4.6.3	THERMAL LANCE	16
4.6.4	WATER JET	16
4.7	ENVIRONMENTAL PRECAUTIONS	17
4.7.1	NOISE	17
4.7.2	WATER	17
4.7.3	AIR POLLUTION	17
4.7.4	HAZARDOUS MATERIAL	17
4.8	POST DEMOLITION PRECAUTIONS	18
4.9	MEASUREMENT AND PAYMENT	18
4.9.1	LABOR RATE	18
4.9.2	COMPOSITE RATE	18

CHAPTER – 4 DISMANTLING (DEMOLITION)

4.1 Demolitions and Preparation of Site

4.1.1 Screens

If specified or directed by the Engineer-in charge, the contractor shall provide, erect and remove screens of canvas or other suitable material to minimize the nuisance from dust and shall provide for watering as the work of demolition proceeds.

4.1.2 Division of Service

The existing services such as electric supply, telephone connection, water supply, drainage, etc. shall be diverted according to the directions and to the satisfaction of the engineer-in-charge.

4.1.3 Inventory of Serviceable Materials

Before taking the work of demolition in hand, an inventory of all serviceable materials for which special care is to be exercised in demolition, handling or lowering down shall be made and the list shall be checked and duly approved by the Engineer-in-charge or his authorized representative. All unserviceable materials, rubbish etc. shall be disposed of as directed by the Engineer in Charge.

4.1.4 Damage

1. The contractor shall be responsible for carrying out dismantling operations strictly in accordance with the specifications or directions of the Engineer-in-charge, with appropriate tools and in such a manner as to avoid unnecessary damage or injury to other adjoining work, and those parts of work which are to be retained, and to render unserviceable as little of the material as possible.
2. The contractor shall, if specified or directed by the Engineer-in charge, make good any damage to work caused during demolition and shall protect as far as possible all trees, shrubs, etc., near the work.

4.1.5 Sewers and Drains

The contractor shall at once remove all foul matter, if sewers or drains are to be removed or disturbed. The rate for removing pipes does not include excavation or the demolition of any masonry or brickwork; all the works shall be paid for separately, according to their respective rate. Wherever, directed by Engineer-in-Charge the Contractor shall also divert these services and install the same as per written instruction of the Engineer-in-Charge.

4.1.6 Shoring or Under-Pinning

Unless otherwise stipulated or specified, no allowance shall be made for shoring or underpinning.

4.1.7 Lowering

Trusses, R. S. beams, battens, purlins, sheets, tiles, boards, wooden frames, water supply and electric fittings and all material liable to be damaged by dropping from a height, shall be

lowered down to the ground by means of rope or another approved appliance. If any serviceable article is damaged or broken on account of the negligence of the contractor, he shall have to pay to the department the current market rates for the article.

4.1.8 Measurement should take during demolition of Certain Elements

1. Doors & Windows

Doors and windows shall be removed from the chowkats along with their hinges before dismantling the later and shall be carefully carried and stacked where directed by the engineer-in-charge.

2. Roof Trusses

The roof structure should be removed to wall plate level manually. Sufficient purloins and bracing should be retained to ensure stability of the remaining roof trusses while each individual truss is removed progressively. Temporary bracing should be introduced, where necessary, to maintain stability. The end frame opposite to the end where dismantling is commenced, should be independently and securely guyed in both directions before commencement of work. The bottom tie of roof trusses should not be cut until the principal rafters are prevented from making outward movement.

3. Heavy Floor Beams

Heavy bulks of timber and steel beams should be supported before cutting at the farthest point and should then be lowered to a safe working place.

4. Jack Arches

Where tie rods are present between main supporting beams, these should not be cut until the arch or series of arches in the floor have been removed. Due care should be exercised and full examination of this type of structure undertaken before demolition is commenced. The floor should be demolished in strips parallel to the span of the arch. rings (at right angles to the main floor beams).

5. Brick Arches

Full time supervision should be given by experienced persons fully conversant in the type of work to ensure that the structure is stable at all times. Dead loads as much as possible may be removed provided it does not interfere with the stability of the main arch rings but it should be noted that the load-carrying capacity of many old arches relies on the filling between the spandrels. The restraining influence of the abutments should not be removed before the dead load of the spandrel fill and the arch rings are removed.

Special temporary support shall be provided in the case of skew bridges. A single span arch can be demolished by hand by cutting narrow segments progressively from each springing parallel to the span of the arch until the width of the arch has been reduced to a minimum which can then be collapsed. Where it is impossible to allow debris to fall to the ground below, centering designed to carry the load should be erected and the arch demolished progressively. The design of the centering should make appropriate allowance for impact.

Where deliberate collapse is feasible the crown may be broken by the demolition ball method working progressively from edges to the centre. Collapse of the structure can be affected in

one action by the use of explosives. Charges should be inserted into boreholes drilled in both arch and abutments. This method is the most effective for demolition of tall viaducts.

In multi-span arches before individual spans are removed, lateral restraint should be provided at the springing level. Demolition may then proceed as for a single span care being taken to demolish the spandrels down to the springing line as the work proceeds. Where explosives are used it is preferable to ensure the collapse of the whole structure in one operation to prevent the chance of leaving unstable portions standing.

6. Cantilevers (Not Part of a Framed Structure)

A cantilever type of construction depends on the super imposed structure for its stability. Canopies, cornices, staircases and balconies should be demolished or supported before the tailing down load is removed.

7. In-Situ Reinforced Concrete

Before commencing demolition, the nature and condition of the concrete, the condition and position of reinforcement, and the possibility of lack of continuity of reinforcement should be ascertained. Attention should be paid to the principles of the structural design to determine which parts of the structure depend on each other to maintain overall stability. Demolition should be commenced by removing partitions and external non-load bearing cladding. It should be noted that in some buildings the frame may rely on the panel walls for stability. Where hard demolition methods are to be used, the following procedures should be adopted.

a. Reinforced Concrete Beams

For beams, a supporting rope should be attached to the beam. The concrete should then be removed from both ends by pneumatic drill and the reinforcement exposed. The reinforcement should then be cut in such a manner so as to allow the beam to be lowered under control to the floor.

b. Reinforced Concrete Columns

In case of columns, the reinforcement should be exposed at the base after restraining wire guy ropes have been placed around the member at the top. The reinforcement should then be cut in such a manner so as to allow the column to be pulled down to the floor under control.

c. Reinforced Concrete Walls

Reinforced concrete walls should be cut into strips and demolished.

4.1.9 Shorting Stacking & Disposal

1. Unless otherwise specified, all demolished materials shall be considered the property of Government and shall be disposed of as directed by the Engineer-in-charge. The rate of an item shall always include the sorting out of any demolished material, its stacking anywhere within 300 feet of the place of demolition and its safe custody till it is handed over to the department in accordance with the directions of the engineer in-charge.
2. When so specified or directed by the Engineer-in-charge, the contractor shall completely remove the whole or part of the dismantled material from the site of work and realize such profits as he can by disposing of it by a method approved in writing

by the Engineer-in charge. In such cases no payment shall be made to the contractor for dismantling this material.

4.1.10 Measurement

Dismantling (Demolition) shall be measured by bulk, surface area or linear dimensions depending upon the article to be dismantled. The units of measurement shall be 100 cu. ft / cu.m, 100 sq. ft. / sq. m or 1 Rft.

4.1.11 Rate

The unit rate for demolition shall include dismantling of material, its careful lowering to the ground, sorting out and stacking within 300 feet of the site of demolition, in accordance with the above specifications.

The rates for dismantling roofs or upper story floors include the dismantling of all materials, except roof supports such as beams and trusses.

4.2 Under – Pinning

4.2.1 Lengths

Unless otherwise specified or directed by the Engineer-in-charge, the underpinning shall be executed in lengths not exceeding 5 feet at a time and all operations shall be carried out to the satisfaction of the Engineer-in-charge. No under-pinning shall be done simultaneously at a distance less than 6 feet apart.

4.2.2 Underpinning of Adjoining Foundations

Where the foundations of new walls are below the level of the foundations of existing walls of adjoining premises, necessary excavation shall be made and underpinning done from the level of the bottom of new foundations up to the underside of foundations of old walls, to the full thickness of the wall. Unless otherwise specified or directed by the Engineer-in-charge, under pinning shall be done in cement concrete 1:3:6 or brickwork first class in 1:3 cement sand mortar.

4.2.3 Planking and Strutting

Planking and strutting shall be provided to side of excavation in underpinning and across trenches if directed by the engineer-in-charge without any additional charge.

4.2.4 Cutting of Projecting Foundation in Old Walls Etc.

The projecting footings and concrete foundations on outside of the old walls to be underpinned shall be cut away back to the face of wall.

4.2.5 Wedging

Unless otherwise specified or directed by the engineer-in-charge, the top of new underpinning shall be wedged and pinned up to the underside of old concrete foundations, when required, with cement sand mortar 1:3 mixed fairly dry and well-rammed.

4.2.6 Temporary Shuttering to Concrete

Temporary shuttering shall be provided to vertical face of concrete foundation to the depth of under-pinning and the same shall be removed when no longer required.

4.2.7 Timbering, Shoring Etc.

Timbering, needling, shoring etc., shall be provided and fixed to ensure the safety of adjoining walls while under-pinning, where specified or directed by the Engineer-in-charge, and, on completion, all disturbed areas shall be cleared and made good.

4.2.8 Measurements

Measurement shall be made of each operation involved in underpinning according to the relevant items of work. The unit of measurement shall be the same as of the relevant items.

4.2.9 Rate

The unit rate shall include underpinning as per above specifications and carriage of materials to the site of work as in case of relevant items of work.

4.3 Shoring

4.3.1 Use

Unless otherwise specified or directed by the engineer-in-charge, all walls, floors, roofs, partitions of building on the site or adjoining the works shall be secured by means of shoring to the entire satisfaction of the Engineer-in-charge, and on completion of the work or when directed by the Engineer-in-charge or his authorized representative the shoring shall be removed and the area left in good order.

4.3.2 Requirements

Unless otherwise specified, the shoring shall generally consist of dog's hoop iron, hooks, shores or rakers, sloe pieces, wall pieces or plates, braces, struts, needles, cleat, wedges a post. The wooden components when used shall be of properly seasoned Shisham, except for rakers and struts which shall be of Sal, free from defects, unless otherwise specified.

4.3.3 Ranking Shores

The ranking shores shall be provided at an angle of 40° to 75° to the building and each set of shores shall be 10 to 15 feet apart or as directed by Engineer-in-charge or his authorized representative. Unless otherwise specified or directed by the Engineer-in-charge, the number of shores provided in each set and the size of rankers shall be as follows:

a. Number of ranking shores in each set

For walls 15 feet to 30 feet high: 2.

For walls 30 feet to 40 feet high: 3.

For walls 40 feet and upwards: 4.

b. Size of the rakers

For walls 15 feet to 20 feet high 4"x4" or 5"x5".

For walls 20 feet to 30 feet high 9"x4½" or 6"x6".

For walls 30 feet to 35 feet high 7"x7"

For walls 35 feet to 40 feet high 6"x12" or 8"x8".

For walls 40 feet to 50 feet high 9"x9".

For walls 50 feet and upwards: 4"x4" and upwards.

4.3.4 Sole Pieces, Needles, Etc.

The sole pieces shall be inclined at an angle of about 85° to the top raker. The top needle shall be at least 2 feet below the top of the wall. In soft ground, the area of the sole piece shall be increased by forming a platform of timber under it. The needle shall be driven into a wall to a depth of 4½ inches, unless otherwise specified.

4.3.5 Wall Piece

The wall pieces shall be 2 inches to 3 inches thick and of the same width as the shore. It shall extend about 3 feet above the top raker and 3 feet below the lowest raker.

4.3.6 Flying Shores

Flying shores shall be erected 10 feet to 15 feet apart with spans upto 35 and placed three quarters of the height of the wall or as directed by the Engineer-in-charge. Unless otherwise shown on the drawing or approved by the Engineer, the general arrangement and the sizes of the scantling shall be as given below:

Span	Horizontal Shore	Struts	Straining Pieces	Wall Plates
Up to 20 Ft	6" x 4"	4" x 4"	4" x 2"	9" x 2"
up to 25 Ft	6" x 6"	4" x 4"	4" x 2"	9" x 2"
up to 30 Ft	9" x 6"	6" x 4"	4" x 2"	11" x 3"
up to 35 Ft	9" x 9"	6" x 6"	6" x 2"	11" x 3"

Table 1, Shoring Requirements (Chapter 4)

Note: Shores of large sections may be built up of smaller sections bolted together.

4.3.7 Needle Shoring

When shown on the approved drawing or when directed by the Engineer-in-charge, the walls being under-pinning shall be supported by needles. The needles shall be 12 inches square of good hard timber such as Sal, with similar posts and the sole pieces spaced from 5 feet to 7 feet apart. R.S. beams shall be used as needles when the wall above is thick, heavy and high.

4.3.8 Measurement and Rates

In respect of measurement and rates the specification for the relevant items of work shall be followed.

4.4 Waste Handling

4.4.1 Chutes

Debris waste and other materials shall not be thrown, tipped or shot down from a height where they are liable to cause injury to any person on or near the site.

Existing lift shaft, light well and openings on floor may be used to convey debris down the building floors. Areas adjacent to the openings of these features used as a chute shall be barricaded when they are not in use. Warning signs shall be posted to prevent workers from entering the area. As an option, plastic chutes may be used inside the floor openings and lift wells to minimize noise and confine the falling debris.

4.4.1.1 Lift Shaft

Lift shaft may be used to convey debris inside the building. The openings to the elevator shall be adequately enclosed to prevent spilling out of debris.

4.4.1.2 Light Well

All the glass windows in the light well shall be taken out or protected before using the light well for conveyance of debris in order to minimize any dangerous situation.

4.4.1.3 Opening on Floor

Openings on the floor may be used to convey debris. If openings are created on the floor, the total openings shall be less than 25% of the total aggregate floor area. Each opening shall not be larger than 900 mm × 900 mm unless otherwise substantiated with standard justifications with regard to the safety of the remaining structure and minimizing the possible risks arising from the impact force induced. Openings shall not cut through structural support elements that may affect the stability of any structural components.

4.4.1.4 Exterior Chutes

No demolition materials shall be allowed to fall freely outside the building unless it is confined within a chute. If exterior chutes are used, adequate clear spaces shall be provided for their operation. Temporary refuse chutes, assembled from old metal barrels shall not be used. The chutes shall not cause any obstruction to the public. A dust barrier shall be provided if the chute outlet is near public access. The chute shall be designed and constructed with adequate strength and support to allow safe conveyance of debris.

4.4.2 Debris Recycling

- Better site management and practice would not only prevent the mixing of the inert portion together with the non-inert portion of construction and demolition waste, but

could also facilitate and allow on site sorting, and separation at source of construction and demolition waste.

- The method of 'selective demolition' should be adopted as far as practicable. It involves demolition and removal of wastes of the same category one at a time. The goal is to facilitate recycling of wastes for beneficial reuse, thus minimizing the burden on municipal landfills and public filling areas. In general, domestic wastes such as furniture, household appliances, etc., metal components such as window frames, pipes, etc., timber components such as doors, wooden floors, etc., other wastes such as tiles, asphaltic materials, ceramic products should be removed first. Most of these materials may be recycled. The building demolition shall begin after all the above non-structural materials have been stripped and removed.
- The sequence of demolition shall be planned to allow the separation and sorting of building materials.
- Concrete and/or brick debris shall be broken down into smaller sizes and separated from reinforced steel for disposal.
- Concrete debris may be pulverized into aggregate size and used for temporary haul roads, fill materials or aggregates for concrete. Old bricks may be salvaged for reuse as architectural features or other uses.
- Broken concrete may be disposed of at construction and demolition (C&D) materials recycling facilities for processing into recycle products and aggregates for beneficial reuse. In the event that broken concrete is mixed with some other wastes, broken concrete should be sorted out on site from the mixture of wastes, before disposal at a C&D materials recycling facility. As regards the way for facilitating the recycling of broken concrete, Authorized Persons / Registered Structural Engineers may seek advice from Civil Engineering and Development Department during the planning stage for demolition.

4.4.3 Dust Minimization

To prevent dust generation during the debris hauling, water spraying shall be applied during the hauling processes. However, the Registered Specialist Contractor (Demolition) shall ensure proper control of water supply and floor drainage system in order to avoid flooding which is a nuisance and may cause overloading of floors.

4.4.4 Debris Accumulation

In general, the debris accumulation on the floors is not allowed unless the debris accumulation is justified by engineering calculations. Debris shall not accumulate against the hoarding or external wall. Excessive accumulation of debris may cause overloading condition and may induce lateral loading on the walls and shall be avoided. The propping design shall include the debris loading.

4.4.5 Debris Disposal and Management System

The debris disposal plans shall generally consist of following details: -

- Method of handling demolished building debris.
- The routing and movement of debris from each floor to on grade holding area prior to leaving the site;
- Means of transportation of debris off site.

- Time and frequency of debris disposal off site.
- Record scheme on the tonnage of each truck load, truck license plate, driver's name, trip tickets and location of dump site.
- The site supervisory personnel responsible for the debris disposal.

4.4.6 Debris Loading

In the case when loaders and trucks have to work, the following conditions shall be considered:

-
- The route of loaders and trucks shall be checked to avoid conflict with temporary propping supports.
- The working headroom shall be checked, any local strengthening to suit removal of mezzanine floor or first floor beams shall be properly designed.
- Loading of the debris shall conform to the Code of Practice for the Loading of Vehicles by the Transport Department.

4.4.7 Waste Management

On-site sorting of surplus construction and demolition (C&D) material is strongly recommended so that inert material can be disposed of at public filling areas as far as practicable, and the remaining C&D waste disposed of at landfills. Care shall be taken for delivering waste disposal to public filling areas require that material to be disposed of at public filling areas must comprise only earth, building debris, broken rock and concrete. Such materials shall be free from marine mud, household refuse, plastic, metal, industrial and chemical waste, animal and vegetable matter and other matter considered unsuitable. Small quantities of timber mixed with otherwise suitable material may be permitted.

All construction and demolition materials arising from or in connection with demolition work shall be sorted on-site and be separated into different groups for disposal at landfills, public filling areas, or recycling as appropriate.

4.5 Demolition by Mechanical Means

4.5.1 Wrecking Ball

4.5.1.1 General

The wrecking ball application consists of a crane equipped with a steel ball. The destruction of the building is by the impact energy of the steel ball suspended from the crawler crane. The wrecking ball operates outside the building. This method is suitable for dilapidated buildings, silos and other industrial facilities. However, the operation requires substantial clear space. The application also demands high level skill operators and well-maintained equipment.

4.5.1.2 Recommended Criteria

The recommended criteria for the use of wrecking ball are presented in the following: -

- Except for special application, the balling of each section of the structure shall proceed from top to bottom. Care shall be taken to maintain the stability of the structure;
- Recommended techniques for the wrecking ball operations include: -

- Vertical Drop - free falling of the wrecking ball onto the structure.
- The boom angle when balling should not be more than 60 degrees to the horizontal. The top of the boom should not be less than three meters above the wall being knocked down.
- Any other building nearer than a distance equal to half the height of the building being demolished is in danger.
- Keep the public well away from balling operations.
- Keep employees clear of the demolition area and make sure that the area is clear each time demolitions resume after break.
- Remember that the shocks from a building being knocked down can be felt in any attached building. Avoid damage to attached buildings by detaching them: hand demolition is necessary for this.
- When a building is being demolished by ball and crane, the crane should provide for sufficient drop height and the ball should be of sufficient weight to enable suitable force to pass through all floor's levels of the building.
- Avoid build-up of debris on floors and against walls.
- A heavy-duty swivel joint must be provided between the ball and the end of the crane rope.
- Check the ball, swivel, rope and the rigging hourly.
- Note the location of all overhead power lines and be aware of these when turning the crane from the normal work face.
- Swing in line - swinging of the ball in-line with the jib. A second dragline will normally connect to the ball horizontally to control the ball motion. The ball shall be swung into the building. The ball shall strike at the top of the member so as to avoid the member from falling outside the building. Slewing the jib is not recommended. The motion of the ball by slewing the jib is difficult to control. It demands expert knowledge of the machine and structure as well as operating skills to safely perform the task. Slewing can potentially induce a tremendous amount of stress on the jib, as such, its use shall be avoided.
- The jib or boom shall be operated with no less than 3 m above the portion of the structure being demolished.
- Clear space for operation between the crane and the structure being demolished shall be 50% of the height of structure, the clear distance between the site boundary and the building to be demolished shall not be less than 50% of the building height plus an additional 6 m for the crane to man oeuvre, these criteria shall apply to all sides of the building to be demolished by wrecking ball.
- The demolition ball shall be connected with swivel type anti-spin device to prevent twisting and tangling of the wire during operation.
- The wire and boom of the machine used for balling shall have a rated capacity, at the working radius, of at least 5 times the weight of the ball.
- The strength of the wire shall be at least twice the tensile strength of the nominal steel reinforcement of the floor slab and beams. The high strength wire allows the pullout of the wrecking ball from potential traps.

4.5.2 Demolition by Pusher Arm

Hydraulically- operated excavators and loaders can be fitted with various attachments for demolition work. Excavator buckets, boom- mounted hydraulic percussion breakers and pusher arm equipment have been successfully used with these machines. The main advantage of such machine is that they are extremely mobile, have a high output, and are able to work on vertical faces and floors above standing level. Their disadvantage is that the

machine needs adequate access, a firm and relatively flat base to work from, and can only work within the reach of their booms. To operate these machines efficiently, the length of boom when fully extended should be at least 1.5 meters above the height of the building being demolished. The pusher arm method is not suitable for large buildings of confined sites, but it is good for masonry infill structure. The building is pushed over in stage by a horizontal force from the machine. An arm is fitted to the lower boom instead of a bucket. The arm is extended forward against the facing wall and force of the excavator pressing forward provides the push.

4.5.2.1 Precautionary Measures

When using this method, always take the following precautions: -

- Ensure that the site has been secured safely to prevent unintentional entry by unauthorized personal during demolition.
- Work from outside the building, never let anyone enter the building while plant is wrecking the building.
- Be sure that the operator has been trained in the work, or is being instructed by a trained person.
- Use hand demolition to get the building to a level where pushing can start.
- Separate the building from any attached buildings using hand methods.
- Make sure that debris does not build up too high against the wall: this may push the wall onto the machine.
- If terraces (ramping) of debris are used to enable the machine and its pusher arm to gain height, ensure that the terraces are well-consolidated and the machine can be maintained level during operation.

4.5.3 Hydraulic Crusher with Long Boom Arm

4.5.3.1 General

The crusher attachment breaks the concrete and the reinforcement by the hydraulic thrust through the long boom arm system. The hydraulic crusher can be operated from the ground outside the building. This method is also suitable for dangerous buildings, silos and other industrial facilities. For environmental reason, it should be used wherever practicable because of its quietness.

4.5.3.2 Application Criteria

- The operation shall have a minimum clear space of 1/2 the building height as a safety zone for the falling debris;
- The equipment shall be inspected and maintained periodically to make sure the equipment is in good and safe condition. The excavator shall operate on firm ground that can support the machine during the crusher operation;
- Except for special applications, each section of the structure shall be demolished in a top down sequence to ensure stability of the structure;
- Debris may be used to build up a platform for the excavator to extend the range of reach. It is important that the debris is densely compacted to support the operation of the excavator. The platform must be flat and the slope must be stable. The height of the buildup platform shall be limited to 3 m. The side slope of the temporary platform shall not be steeper than 1:1 (horizontal to vertical) unless the condition allows a steeper slope. The slope of access ramp for the machine shall be in accordance with

the manufacturer's recommendation. The width in both directions of the platform shall be at least one and one-half the length of the machine to allow safe manoeuvre during the demolition operation;

- To minimize the dust impact, the structure shall be pre-soaked with water before demolition. Water shall be continuously sprayed during the crushing operation;
- Debris may fall out of the building during the demolition. The site shall be completely fenced off. There shall be 24-hour guarded security to allow only authorized personnel for site access. During the operation of the crusher there shall be no worker within the machine operating area or inside the building;
- The crusher operator shall possess the essential skills and significant experience in the crusher operation. There shall be a spot person to assist in the operation and alert the operator of any potential problem during the operation.

4.5.4 Demolition by Wire Rope Pulling

This method is a form of deliberate collapse. Cables and wire ropes are fixed to key structural members, then pulled down by tractors or winches. It is suitable for detached buildings where there is plenty of surrounding room. The method can be used for timber framed buildings, bridges, bricks, masonry or steel chimneys, and for spires and masts. When using this method, always take the followings precautions: -

- Use wire ropes of at least 16 mm in diameter, and check them regularly. Wire ropes must have a factor of safety of 6.
- Anchor the machine securely, and set it so that the rope is flatter than 1 inch.
- Do not let anyone stand between the tractor and the building, or beside the rope.
- Have a full Rops And Fops canopy on the tractor to protect the operator from broken ropes and falling objects.
- Never let anyone enter the building while pulling is in progress.
- Ensure the ropes are properly secured before commencing the pull.
- Ensure that the pulling ropes are kept clear of overhead power lines, especially when taking up the rope slack.
- Remember that pylons and masts can twist as they are pulled. If the legs are different lengths, the pylon could fall at right angles to the pull.

4.5.5 Mechanical Method by Clam Shell

Demolition by clam shell typically involves the use of a crane equipped with a clam shell attachment which progressively bites away the structure. Special conditions for clam shell are listed in the following: -

- A minimum safety distance of 0.5 times the height of the building element being demolished shall be maintained between the machine and the building during the operation;
- The process of biting off the structural elements shall begin from the top and progress downwards; and
- The clam shell shall be operated not less than 1 m above the structure being demolished.

4.5.6 Jack Hammer

A jackhammer is a pneumatic or electro-mechanical tool that combines a hammer directly with a chisel. Hand-held jackhammers are generally powered by compressed air, but some are also powered by electric motors. Larger jackhammers, such as rig mounted hammers used on construction machinery, are usually hydraulically powered. They are typically used to break up rock, pavement, and concrete.

There are different types of jack hammer such as dry type, wet type which can be used for different purposes such concrete breaker, rock drifter. Contractor should use jack hammer of approved type and standard after getting approval from Engineer in in charge and should follow the precautionary measures mention in this chapter of specifications.

- Use the right chisel and/or tip for the material to be broken. Contractor should use rock point for rock, spade point for asphalt, and chisel point for concrete or otherwise as recommended by Engineer in Charge. Never use a broken or cracked point.
- Inspect the jackhammer and equipment regularly for defect or damage. Check that everything is in place and that all safety precautions are being followed. Do not forget about the hoses too.
- The jackhammer shall be used at a slight angle, towards operator, so the possibility of getting stuck with the tip or chisel into the surface is minimized. It will also allow operator to get better control and grip of the jackhammer. tool from getting out of control.
- If the jackhammer gets stuck, try to release it by moving it back and forth from side to side. If it's still stuck, install another bit into the jackhammer and try to release if by working at an angle.
- If using an electric jackhammer, workers must locate the electrical cord on their shoulder to prevent accidental damages to the cord that can cause electrocution.
- Always use a water spray control system to minimize airborne dust.
- Operator should Always wear safety glasses, ear protection, gloves, face protection and shoes when using the tool.

4.6 Other Methods

4.6.1 Non-Explosive Demolition Agent

Non-Explosive Demolition Agent (NEDA) is a static demolition agent. When the reaction takes place in a confined drill hole, the NEDA generates an expansive pressure to crack and break concrete and stone.

The NEDA is a suitable application in a restrictive environment where noise, flying debris and vibration are less tolerated. A drilling pattern shall first be designed. For large projects, test breaking shall be performed. The NEDA shall be mixed with water to form a slurry and immediately placed into the pre-drilled holes. The loading intensity and water content shall be controlled to optimize the expansive pressure and prevent blow-out of the NEDA. The breaking effect of NEDA is relatively small comparing to explosives. Secondary efforts are required to further break down and remove the debris by mechanical means. NEDA may be used on foundation works, pile caps or structures that are fully supported. When used in rock, NEDA should be contained within strong, flexible, impermeable bags to prevent uncontrolled entry into rock joints.

4.6.2 Saw Cutting

Saw cutting is suitable for alteration and additional works where accuracy in the cutting is important and the tolerance to noise and vibration is very limited. It can be used to cut concrete slabs and wall elements into segments. An entire building may be dismantled by saw cutting. Saw cutting generally includes conventional disc saw and chain saw, diamond core stitch drilling and wire saw.

4.6.2.1 Wire Saw Cutting

Wire saw cutting comprises a special steel wire often impregnated with diamond beads to increase its cutting ability. The wire saw method is a suitable application for projects that require precision and total control of demolition work. A hole shall first be pre-drilled for the passage of the diamond wire, the wire cutting operation follows. Because of its flexibility, it may be used for "hard to reach" areas. A diamond wire saw may also be applied in cutting off piling of marine structures and bridges.

4.6.2.2 Diamond Core Stitch Drilling

Diamond core stitch drilling may be adopted to cut concrete elements by continuously coring a set of holes to carve up the concrete structure. The thickness of the concrete to be cut depends on the depth of the drilling or coring equipment. Diamond core stitch drilling is particularly suitable in the removal of existing pile cap for construction of large diameter bored pile foundation.

4.6.2.3 Management of Process Water

The sawing and drilling operations require large amounts of water to cool down the blade which cuts through the concrete at high speed. Provision shall be made to provide a water source for the operation and for the disposal of the cooling water.

4.6.3 Thermal Lance

Cutting of reinforced concrete by thermal lance involves very high temperature up to 2,000 - 4,000°C. The extremely high heat requires special precautionary measures and care. The use of a thermal lance in cutting reinforced concrete shall not be used unless: -

- The project demonstrated that there is no other viable alternative;
- Adequate protective measures are provided to isolate the operation and to prevent any potential fire spreading out; and
- Adequate protective measures are provided to prevent the injury of the workers, and any third party by flame and the molten concrete.

4.6.4 Water Jet

Water jetting involves the use of a water jet stream pumped at high pressure to erode the cement matrix and wash out the aggregates. Abrasive compounds may be added for cutting reinforcing steel. The application of the water jetting shall be subject to the following criteria: -

- City water supply shall be used in water jet cutting. Provision shall be included to dispose the water used in the operation, and to recycle the water for continuous operation through local filtration and sedimentation;

- The area behind the structural member to be cut shall be shielded to avoid damage to persons and properties during the cutting; and
- In the case when abrasive water jets are used, further precautionary measures shall be provided in accordance with manufacturer recommendations to confine the rebound of the abrasive compounds. All site personnel shall wear adequate safety cover and clothing.

4.7 Environmental Precautions

The general requirements to minimize environmental impacts from construction sites can also be applied to demolition processes. The following sections contain some of the procedures to be adopted: -

4.7.1 Noise

Noise pollution arising from the demolition works including, but not limited to, the use of specified powered mechanical equipment (SPME), powered mechanical equipment (PME), such as pneumatic breakers, excavators and generators, etc., scaffolding, erection of temporary works, loading and transportation of debris, etc. affects the workers, and the sensitive receivers in the vicinity of the demolition site. Silent type PME shall be used to reduce noise impact as much as practicable. Demolition activity shall not be performed within the restricted hours as established by EPA. To minimize such impacts, the contractor for subproject should be requested by the construction supervision consultants (engineer) to provide evidence and certification that all equipment to be used for construction is fitted with the necessary air pollution and noise dampening devices to meet EPA requirements. No works involving the use of Powered Mechanical Equipment and/or Specified Powered Mechanical Equipment within restricted hours should be allowed without a valid Construction Noise Permit (CNP) issued by the EPA. The requirement shall be referred to the Technical Memorandum on Noise from Construction Work in Designated Areas. Noise from construction activities is not covered under any regulations however in order to keep in line with best international practice it is recommended that no construction should be allowed during nighttime (9 PM to 6 AM).

4.7.2 Water

The discharge of wastewater from demolition sites requires a valid discharge license from the EPA and the application of such a license shall be made under the Water Pollution Control Ordinance (WPCO). Effluent shall be treated to the standards as stipulated in the license before discharge. As stated in 4.4.3 Dust Minimization, the Registered Specialist Contractor (Demolition) shall maintain proper control of temporary water supply and an effective temporary drainage system.

4.7.3 Air Pollution

Concrete breaking, handling of debris and hauling process are main sources of dust from building demolition. Dust mitigation measures complying with the Air Pollution Control (Construction Dust) Regulations shall be adopted to minimize dust emissions. Burning of waste shall not be allowed. Diesel fumes generated by mechanical plant or equipment shall be subject to the control of the Air Pollution Control (Smoke) Regulations.

4.7.4 Hazardous Material

Materials such as LPG cylinders in domestic flats, toxic and corrosive chemicals for industrial undertakings, and any other hazardous materials have to be identified and properly handled and removed prior to the commencement of the demolition of the building. The management of waste must fully comply with the Waste Disposal Ordinance. Additionally, management of waste which is classifiable as a chemical waste must also comply with the Waste Disposal (Chemical Waste) (General) Regulation. The Environmental Protection Act-1997 should be consulted if in case of doubt about the waste classification.

4.8 Post Demolition Precautions

Once the demolition is completed, the site shall be reinstated to eliminate any potential hazard to the public. The following precautionary measures shall be considered: -

- The site shall be levelled and cleared of any debris. Adequate drainage shall be provided;
- If the new development is not immediately commenced, the site shall be completely enclosed to prevent public trespassing;
- Supports to adjacent building structures, weather-proofing and stabilization of exposed party walls shall be completed. A final inspection by the Authorized Person and the Registered Structural Engineer on the supports of adjacent structures shall be conducted to ensure satisfactory and safe conditions before leaving the site. If temporary shoring remains on site, inspection and maintenance shall be continued until the temporary shoring is removed or replaced by permanent supports;
- Any excavation shall be braced and stabilized; and
- For sloping sites, and/or sites with retaining wall supporting ground, the following additional precautionary measures shall be included: -
 - The ground surface shall be sealed up to prevent water infiltration;
 - Any unstable structures and ground shall be stabilized; and
 - The demolition plans shall be provided to the subsequent foundation or site formation contractor so that any temporary support works constructed during demolition are maintained during the new development phases.

4.9 Measurement and Payment

4.9.1 Labor Rate

The measurement and payment for the items of the work of Brickwork hereof shall be made corresponding to applicable CSR item as provided in Contract Agreement and shall constitute full compensation for procurement transportation, performance in all respects and completion of work as specified including site clearance, as approved by the Engineer-in-Charge except the cost of materials to be provided by Department at designated location as defined in the Contract Agreement.

4.9.2 Composite Rate

The measurement and payment for the items of the work of Brickwork hereof shall be made corresponding to the applicable CSR items as provided in Contract Agreement and shall constitute full compensation, for procurement, transportation, performance in all respects and completion of work as specified including the site clearance as approved by the Engineer-in-Charge.

Contents

CHAPTER – 5	MORTAR	2
5.1	Purpose and Use	2
5.2	Types of Mortars	4
5.2.1	Mud Mortar	4
5.2.2	Cement Mortar	5
5.2.3	Lime Mortar	5
5.2.4	Lime Cement Mortar	6
5.2.5	Mortar for Fire-Clay Brickwork	7

CHAPTER – 5 MORTAR

5.1 Purpose and Use

a. Mud Mortar

Mud mortar shall be used in brickwork, masonry and plaster work, provided these works are not likely to remain under water. For brickwork and masonry, mud mortar shall be prepared from good brick earth. Brick earth shall be reduced into fine powder and freed from stones, grass, kankar, roots and other matter. Clay containing efflorescent salts or taken from a locality where there are white ants shall not be used. The mortar shall be made by mixing clay with water on a plot of ground specially cleared and set apart for the purpose, and tempered for at least two days. During this period, it shall be worked up at intervals with men's feet and phowrahs. If necessary or where soil is too clayey, sand or chopped straw shall be added. The consistency of the mortar shall be kept to the extent that it readily slides off the face of a trowel but is not so wet as to part into large drops in falling.

Mud mortar for plastering shall be prepared in the same way as described above, except that four pounds of chopped "bhoosa" shall be mixed thoroughly with each cubic feet of mortar which shall be kept in a plastic state for a week and shall be worked up by pugging with feet at intervals.

b. Cement Mortar

Cement mortar shall be used in brickwork, masonry, plaster work and concrete work. Its ingredients are cement and sand whose proportions may be 1:2, 1:3, 1:4, 1:5, 1:6, 1:7, 1:8 and so on by volume. The mortar shall be made by thoroughly mixing the ingredients in a dry state and then gauging the mix with water to make it workable. The quantity (weight) of water to be added with a fine rose shall be 28% of the weight of cement plus 4% of the weight of the total aggregate. This assumes that the materials (aggregates) are dry.

c. Lime Mortar

This mortar shall be used in brickwork, masonry, plaster work and concrete work. Its ingredients are slaked stone lime and Surkhi or kankar lime and sand. Non-hydraulic or semi-hydraulic lime mortars have low strength and are vulnerable to frost and, therefore, unsuitable for external work for which only hydraulic lime mortars may be used. The proportions of different mixes may be below: -

Mortar	Ingredients		Remarks
Stone Lime and Surkhi	Stone Lime	1 Part	
	Surkhi	1 ½ Parts	
Kankar Lime and Sand	Lime	1 Part	Very strong Mortar
	Sand	1 Part	
	Lime	1 Part	Strong Mortar
	Sand	2 Part	
	Lime	1 Part	Ordinary Mortar
	Sand	3 Part	

Table 1, Lime Mortar Proportion (Chapter 5)

The mortar shall be prepared by mixing the ingredients twice in a dry state and then grinding the mix with sufficient water in a grinding mill.

d. Lime Cement Mortar

Lime cement mortar shall be used in brickwork, masonry, plaster work and concrete work. Its ingredients slaked stone lime, cement and sand (fine aggregate). Usually their proportion taken by volume may be as follow: -

Lime		Cement		Sand
1	:	1	:	5
1	:	1	:	6
1	:	1	:	8
1	:		:	9
1	:	1	:	10
1	:	1	:	12
1	:	3	:	8
1	:	3	:	3

Table 2, Lime Cement Mortar (Chapter 5)

The presence of cement in the mortar ensures early strength and reduced the risk of frost attack both during setting and afterwards, while the presence of lime improves the working quality of mortar and reduced its tendency to shrink and crack on drying. The mortar shall be prepared by mixing, in a dry state, the thoroughly slaked and screened stone lime and sand, and then adding cement which shall be properly mixed with this material. Later the water shall be poured through a fine rose to give a mortar of the desired working consistency.

e. Mortar for Fire Brickwork

Fire-clay or alternatively fire-cement is suitable for setting fire bricks. Generally, the joints are the most vulnerable part of fire brickwork and when they crumble away, the arises of these bricks become vulnerable to heat. Fire-clay can be used just as it comes out of hearth but intends to contract at cooling and again expands on exposure to heat; so, the best way is to use fire-cement that is especially prepared to resist construction under heat. Burnt clay, made by crushing ordinary fire bricks, does not expand or contract markedly and therefore constitutes a suitable aggregate for fire brick mortar mixed with high alumina or other bauxite cement.

The proportion of alumina cement to crushed fire brick shall be 1:2. The mortar shall be prepared in the same manner as described for cement mortars.

f. Mortar with Plasticizer

It is often better to use a proprietary with cement and sand than to use lime. It increases the “wetting” of cement particles, and the effectiveness of cement, permitting a weaker mix and improving its workability. It also tends to entertain air bubbles in the mix, making the mortar more elastic when set and reducing the chances of cracking. The recommended mixes vary, but the common one is one part of cement, to six parts of sand plus the amount of plasticizer (usually added to the mixing water) recommended by the manufacturer.

5.2 Types of Mortars

5.2.1 Mud Mortar

1. Composition

Mud mortar for brickwork and masonry shall be prepared from good earth and water. Sand or chopped straw shall be added to the earth that it is too clayey. Mud mortar for plastering shall be prepared from earth, water and chopped "bhoosa".

a. Earth

Earth shall be good brick earth or clay conforming to the Specification and shall be obtained from an approved source.

b. Water

Water shall conform to the Specification given in Book 1 (Specification for Engineering Material).

2. Preparation

Clay shall be mixed with water on a plot of ground especially cleared for the purpose and tempered for at least two days. During this period, it shall be worked up at intervals with men's feet and "phowrahs" Sand for chopped straw shall be added, as desired, to the earth that is too clayey. Mud mortar for plastering shall be prepared as specified above and four pounds of chopped "bhoosa" shall be thoroughly mixed with each cubic foot of mortar.

a. Consistency

The consistency of mud mortar shall be of a type that it shall readily slide off the face of trowel, but the mortar shall not be so wet that its parts into large drops in falling. No water shall be added to the mortar after it is delivered to job.

b. Pits

Unless otherwise specified or directed by the Engineer-in-charge, the contractor shall make his own arrangements for obtaining the necessary clay for the mortar. When permitted by the Engineer-in-charge to take earth from the site of work, the contractor shall fill all pits with good earth and dress them off properly on the completion of work.

E. Restriction of Use

Mud mortar shall not be used for any masonry or brickwork likely to remain under water at any time or likely to bear pressure other than directly vertical.

2. Measurement

The measurement of mortar, if required, shall be done by volume. The unit of measurement shall be 100 cubic feet.

3. Rate

The unit rate shall include the cost of clay, water and chopped straw or chopped "bhoosa" as specified and the preparation of mortar as per above specification at the site of work to be defined in the condition of contract.

5.2.2 Cement Mortar

1. Composition

Cement mortar shall consist of Portland cement, shall conform to ASTM C 150-94 Type I or B.S.S.12, sand (fine aggregate) and Water. The specifications of these materials have been defined Book 1 (Specification for Engineering Material). Waterproofing agent shall be added when specially required or directed by the Engineer-in-charge.

a. Mix

Unless otherwise specified or directed by the Engineer-in-charge, the ingredients for cement mortar shall be proportioned by volume.

2. Preparations

Cement and sand shall be thoroughly mixed in a dry state on a pucca platform or in troughs as directed by the Engineer-in-charge. It shall be gauged with a quantity of water sufficient to make the mortar workable. Water shall be added with a fine rose. Only such quantity of mortar shall be prepared as can be used before the initial setting time.

a. Precautions

- i). Any mortar which has not been used within 30 minutes of the addition of water shall be discarded.
- ii). At the close of day's work, the mixing troughs and pans shall be thoroughly washed and cleaned.
- iii). The mixing platform shall not be used for stacking materials.

3. Measurement

Measurement of mortar, if required, shall be done by volume. The unit of measurement shall be 100 cubic feet.

4. Rate

The unit rate shall include the cost of Portland cement, sand and water and the preparation of mortar as per above specifications at the site of work to be defined in the conditions of contract.

5.2.3 Lime Mortar

1. Composition

Lime mortar shall consist of slaked stone lime, Surkhi and water or kankar lime, sand and water. The specifications of these materials have been defined in Book 1 (Specification for Engineering Material).

a. Mix

Unless otherwise specified or directed by the Engineer-in-charge, the ingredients for lime mortar shall be proportioned by volume.

2. Preparation

a. Mortar for Masonry and Brickwork

Thoroughly slaked and screened stone lime/kankar lime and Surkhi/sand shall be measured in boxes and mixed on a pucca platform or in a mixing trough as specified. The troughs, if used, shall be capable of being washed and drained. These ingredients shall be mixed twice in a dry state and then ground in a grinding mill with a quantity of water sufficient to produce a mortar of specified consistency.

b. Mortar for Plastering or Pointing

Unless otherwise specified one part of lime mixed with two parts of Surkhi by volume shall be kept under water for at least 12 hours, and then made to pass through a screen of 12x12 meshes to a square inch. Requisite coloring material shall be added to it and the mortar applied as fresh as possible.

3. Measurement

The measurement of mortar, if required, shall be done by volume. The unit of measurement shall be 100 cubic feet.

4. Rate

The unit rate shall include the cost of stone lime/kankar lime, sand/Surkhi, and water and the preparation of mortars as per above specifications at the site of work to be defined in the conditions of contract.

5.2.4 Lime Cement Mortar

1. Composition

Lime cement mortar shall consist of Portland cement, slaked stone lime, sand and water. The specifications of these materials have been defined in Book 1 (Specification for Engineering Material).

a. Mix

Unless otherwise specified the ingredient of lime cement mortar shall be proportioned by volume.

2. Preparation

Thoroughly slaked and screened stone lime and sand in requisite quantities shall thoroughly mixed and then a necessary quantity of cement shall be added. When this has been uniformly mixed a quantity of water sufficient to give a mortar of desired consistency shall be added through a fine rose.

a. Precautions

Any mortar which has not been used within 30 minutes of the addition of water shall be discarded. At the close of day's work, the mixing troughs and pans shall be thoroughly washed

and cleaned.

3. Measurement

The measurement of mortar, if required, shall be done by volume. The unit of measurement shall be 100 cubic feet.

4. Rate

The unit rate shall include the cost of Portland cement, slaked stone lime, sand and water and the Preparation of mortar as per above specifications at the site of work to be defined in the conditions of contract.

5.2.5 Mortar for Fire-Clay Brickwork

1. Composition

Unless otherwise specified, the mortar shall consist of alumina cement, crushed fire bricks graded as sand and water. The specifications of these materials have been defined in Book 1 (Specification for Engineering Material).

2. Other Respects

In all other respects (e.g. preparation, precautions, measurement and rate) the mortar shall conform to the specification of cement mortar.

Contents

CHAPTER – 6	CEMENT CONCRETE	7
6.1	General	10
6.1.1	Description	10
6.1.2	Glossary	10
6.1.3	Classes of Concrete	64
6.1.4	Materials	65
6.2	Proportioning of Concrete	75
6.2.1	Mix Design	75
6.2.2	Water Cement Ratio Law	77
6.2.3	Volumetric Proportions (Cement: Sand: Aggregate)	78
6.3	Manufacture of Concrete	80
6.3.1	Storage of Aggregate	80
6.3.2	Storage of Cement	80
6.3.3	Measurement of Material	80
6.3.4	Batching and Mixing of Concrete	80
6.3.5	Transporting Concrete	84
6.3.6	Sampling and Testing	93
6.3.7	Evaluation of Concrete Strength	95
6.4	Protection of Concrete from Environmental Conditions	97
6.4.1	General	97
6.4.2	Rain Protection	97
6.4.3	Hot and Weather Protection	97
6.4.4	Cold Weather Protection	97
6.4.5	Special Requirements for Bridge Decks	98
6.4.6	Concrete Exposed to Salts Water	98
6.4.7	Concrete Exposed to Sulfate Soils or Water	99
6.5	Form Work	100
6.5.1	Material Requirements	100
6.5.2	Formwork Design	103
6.5.3	Formwork Construction	104
6.5.4	Treatment of Formwork Construction	105
6.5.5	Preparation for Concrete Placing	105
6.5.6	Removal of Forms	107
6.5.7	Measurement and Payment	107
6.6	Handling and Placing Concrete	108
6.6.1	General	108

6.6.2	Sequence of Placing	108
6.6.3	Placing Methods	109
6.6.4	Consolidation	110
6.6.5	Placing Concrete Underwater	110
6.6.6	Placing Concrete under Sea Water	112
6.6.7	Placing Concrete in Saline Soil	112
6.6.8	Compaction	112
6.7	Cover Over Reinforcement	115
6.8	Construction Joints	115
6.8.1	General	115
6.8.2	Bonding	115
6.8.3	Bonding and Doweling to Existing Structures	115
6.8.4	Forms at Construction Joints	116
6.9	Contraction & Expansion Joints	117
6.9.1	General	117
6.9.2	Material	117
6.9.3	Installation	118
6.10	Curing Concrete	120
6.10.1	Effect of Temperature	120
6.10.2	Period of Curing	120
6.10.3	Moist Curing	120
6.10.4	Spraying	121
6.10.5	Ponding	121
6.10.6	Wet Coverings	121
6.11	Finishing Concrete Surfaces	122
6.11.1	General	122
6.11.2	Finishing of Roadway Surface	122
6.11.3	Pedestrian Walkway Surface Finish	124
6.11.4	Finishing Formed Concrete Surfaces	124
6.11.5	Wire Brushed or Scrubbed Finish	125
6.11.6	Concrete Coloring	125
6.11.7	Concrete Polishing	126
6.12	Pre-Cast Concrete Members	127
6.12.1	General	127
6.12.2	Pre-Casting Floor	127
6.12.3	Materials and Manufacturing	127
6.12.4	Molds	128

6.12.5	Storage and Handling.....	129
6.12.6	Erection.....	129
6.12.7	Curing.....	129
6.12.8	Other Respects.....	129
6.13	Molded Cement Concrete Article.....	131
6.13.1	General.....	131
6.13.2	Molding.....	131
6.13.3	Carborandum Non-Skid Surface.....	131
6.13.4	Nipper Holes and V-Grooves.....	131
6.13.5	Other Respects.....	131
6.13.6	Measurement and Payment.....	131
6.13.7	Rate.....	132
6.14	Mortar and Grout.....	133
6.14.1	General.....	133
6.14.2	Materials and Mixing.....	133
6.14.3	Placing and Curing.....	133
6.15	Application of Loads.....	133
6.15.1	General.....	134
6.15.2	Earth Loads.....	134
6.15.3	Construction Loads.....	134
6.16	Measurement and Rate.....	135
6.16.1	Measurement.....	135
6.16.2	Rate.....	135
6.17	Reinforced and Pre-stressed Cement Concrete.....	136
6.17.1	Material Requirements.....	136
6.17.2	Construction Requirements.....	138
6.17.3	Measurement and Payment.....	147
6.18	Lime Concrete.....	148
6.18.1	Material Requirements.....	148
6.18.2	Construction Requirements.....	148
6.18.3	Measurement and Rates.....	149
6.19	Reinforcement.....	150
6.19.1	Description.....	150
6.19.2	Materials.....	150
6.19.3	Bar Lists and Bending Diagram.....	151
6.19.4	Fabrication.....	151
6.19.5	Handling, Storage, Surface Condition and testing of Reinforcement....	152

6.19.6	Placing and Fasting	154
6.19.7	Splicing of Bars	154
6.19.8	Substitutions	155
6.19.9	Measurements and Rates	155
6.20	Damp Proof Course	156
6.20.1	Cement Concrete D.P.C.....	156
6.20.2	DPC Of Cement Sand Plaster.....	157
6.20.3	Marble DPC	158
6.20.4	Jutoid (Jute Based) DPC	160
6.21	Cement Concrete Block Masonry	162
6.21.1	Scope.....	162
6.21.2	Materials	162
6.21.3	Concrete Block Making	163
6.21.4	Properties of Blocks	164
6.21.5	Suction Rate.....	164
6.21.6	Soluble Salt Content.....	164
6.21.7	Reinforcing and Anchors of Block Masonry	165
6.21.8	Erection	165
6.21.9	Scaffolding	166
6.21.10	Jointing	166
6.21.11	Tolerances	166
6.21.12	Damp Proof Course.....	166
6.21.13	Solid Block Work Around Opening of Hollow Masonry.....	166
6.21.14	Curing and Repairs	166
6.21.15	Masonry Short of Height.....	167
6.21.16	Measurement and Payment	167
6.22	Cement Concrete Hollow Block Masonry.....	169
6.22.1	Scope.....	169
6.22.2	Materials	169
6.22.3	Concrete Hollow Making	170
6.22.4	Properties of Blocks	170
6.22.5	Suction Rate.....	171
6.22.6	Soluble Salt Content.....	171
6.22.7	Reinforcing and Anchors of Block Masonry	171
6.22.8	Erection	171
6.22.9	Scaffolding	172
6.22.10	Jointing	172

6.22.11	Tolerances	172
6.22.12	Damp Proof Course.....	172
6.22.13	Reinforced Hollow Block Masonry.....	173
6.22.14	Curing and Repairs	173
6.22.15	Masonry Short of Height.....	173
6.22.16	Measurement and Payment	173
6.23	Ready Mix Concrete.....	176
6.23.1	Description	176
6.23.2	Materials Requirements, Storage and Handling	176
6.23.3	Construction Requirement.....	177
6.23.4	Measurements & Payment	183
6.24	Shotcrete	183
6.24.1	Description	183
6.24.3	Material Requirement	183
6.24.4	Construction Requirements	184
6.24.5	Measurement and Payment.....	188
6.25	Mass Concrete	189
6.25.1	Description	189
6.25.2	Material Requirements	190
6.25.3	Construction Requirements.....	190
6.25.4	Measurement & Payment	192
6.26	Materials and Construction of RCSPs Building System	193

LIST OF TABLES

TABLE 1, CLASSES OF CONCRETE AND THEIR STRENGTH (CHAPTER 6).....	64
TABLE 2, GRADING OF FINE AGGREGATES (CHAPTER 6).....	67
TABLE 3, GRADING OF SAND (CHAPTER 6).....	68
TABLE 4, GRADING OF COARSE AGGREGATES (CHAPTER 6).....	68
TABLE 5, GRADING REQUIREMENTS FOR COARSE AGGREGATE, ASTM C-33-03 (CHAPTER 6).....	70
TABLE 6, WATER REQUIREMENT (CHAPTER 6).....	71
TABLE 7, SLUMP REQUIREMENTS (CHAPTER 6).....	76
TABLE 8, SIZES OF BOX (CHAPTER 6).....	81
TABLE 9, APPROXIMATE YIELD OF CONCRETE PER BAG OF CEMENT AND VOLUME OF LOOSE MATERIALS (CHAPTER 6).....	82
TABLE 10, TOLERANCES FOR WEIGHTS OF CONCRETE BATCHING INGREDIENTS (CHAPTER 6).....	83
TABLE 11, MIXING PERIODS FOR CONCRETE (CHAPTER 6).....	84
TABLE 12, METHODS AND EQUIPMENT FOR TRANSPORTING AND HANDLING CONCRETE (CHAPTER 6).....	93
TABLE 13, MINIMUM CUBE STRENGTH REQUIREMENTS (CHAPTER 6).....	95
TABLE 14, 28 DAYS CUBE STRENGTH (CHAPTER 6).....	95
TABLE 15, REQUIREMENT FOR AN EXTENDED PERIOD OF CONTROLLED TEMPERATURE (CHAPTER 6).....	97
TABLE 16, FORM MATERIALS WITH DATA SOURCES FOR DESIGN AND SPECIFICATIONS (CHAPTER 6).....	101
TABLE 17, REMOVAL OF FORMS (CHAPTER 6).....	107
TABLE 18, PHYSICAL CHARACTERISTICS OF PVC WATER STOP (CHAPTER 6).....	119
TABLE 19, BREAKING STRENGTH REQUIREMENTS AS PER ASTM A-416 (CHAPTER 6).....	136
TABLE 20, YIELD STRENGTH REQUIREMENTS AS PER ASTM A-416.....	137
TABLE 21, MINIMUM TIME REQUIRED FOR REMOVAL OF FORMWORK (CHAPTER 6).....	147
TABLE 22, DEFORMED BAR DESIGNATION NUMBERS, NOMINAL WEIGHTS [MASSES], NOMINAL DIMENSIONS, AND DEFORMATION REQUIREMENTS (CHAPTER 6).....	151
TABLE 23, TENSILE REQUIREMENTS (CHAPTER 6).....	153
TABLE 24, BEND TEST REQUIREMENTS (CHAPTER 6).....	153
TABLE 25, BAR SIZES AND WEIGHT OF BARS (CHAPTER 6).....	155
TABLE 26, GRADING REQUIREMENTS (CHAPTER 6).....	162
TABLE 27, CHLORIDES AND SULPHATES AMOUNT IN WATER (CHAPTER 6).....	163
TABLE 28, PROPERTIES OF SOLID BLOCKS (CHAPTER 6).....	164
TABLE 29, GRADING REQUIREMENTS (CHAPTER 6).....	169
TABLE 30, PROPERTIES OF HOLLOW BLOCKS (CHAPTER 6).....	171
TABLE 31, MASS CONCRETE REQUIREMENTS OF ACI 301 (2016) (CHAPTER 6).....	190
TABLE 32, GRADING REQUIREMENTS FOR COARSE AGGREGATE FOR MASS CONCRETE (CHAPTER 6).....	190
TABLE 33, RANGES IN EACH SIZE FRACTION OF COARSE AGGREGATE THAT HAVE PRODUCED WORKABLE CONCRETE (CHAPTER 6)...	191

CHAPTER – 6 CEMENT CONCRETE**References:**

Following International standards should be followed during execution of works:

Sr.#	Standard Name	Description
AASHTO		
1.	AASHTO M 6	Specification for Fine Aggregate for Hydraulic Cement Concrete.
2.	AASHTO M 157	Mixing of concrete
3.	AASHTO T 141 (ASTM C 172)	Standard Method of Test for Sampling Freshly Mixed Concrete.
4.	AASHTO T 121 (ASTM C 138)	Determination of density, or unit weight, of freshly mixed concrete.
5.	AASHTO T 27	Sieve analysis of fine and coarse aggregate.
6.	AASHTO T 119 (ASTM C 143)	Standard Method of Test for Slump of Hydraulic Cement Concrete.
7.	AASHTO T 152 (ASTM C 231)	Standard Method of Test for Air Content of Freshly Mixed Concrete.
8.	AASHTO T 84 (ASTM C 128)	Standard Method of Test for Specific Gravity and Absorption of Fine Aggregate.
9.	AASHTO T 85 (ASTM C 127)	Standard Method of Test for Specific Gravity and Absorption of Coarse Aggregate.
10.	AASHTO T 126 (ASTM C 192)	Standard Method of Test for Making and Curing Concrete Test Specimens in the Laboratory.
11.	AASHTO T 23 (ASTM C 31)	Standard Method of Test for Making and Curing Concrete Test Specimens in the Field.
12.	AASHTO T 22 (ASTM C 39)	Compressive Strength of Cylindrical Concrete Specimens.
13.	AASHTO T -24	Standard Method of Test for Obtaining and Testing Drilled Cores and Sawed Beams of Concrete.
ASTM		
14.	ASTM C 567	Standard Test Method for Determining Density of Structural Lightweight Concrete.
15.	ASTM C-330	Standard Specification for Lightweight Aggregates for Structural Concrete.
16.	ASTM C-260	Standard Specification for Air-Entraining Admixtures for Concrete.
17.	ASTM C-494	Standard Specification for Chemical Admixtures for Concrete.
18.	ASTM C-618	Standard Specification for Coal Fly Ash and Raw or Calcined Natural Pozzolan for Use in Concrete.
19.	ASTM C-94	Standard Specification for Ready-Mixed Concrete.
20.	ASTM C 33	Standard specification for coarse aggregate.
21.	ASTM D-1751	Standard Specification for Preformed Expansion Joint Filler for Concrete Paving and Structural Construction (Non-extruding and Resilient Bituminous Types).
22.	ASTM D-1752	Standard Specification for Preformed Sponge Rubber, Cork and Recycled PVC Expansion Joint Fillers for Concrete Paving and Structural Construction.
23.	ASTM D- 994	Standard Specification for Preformed Expansion Joint Filler for Concrete (Bituminous Type).

24.	ASTM C-203	Test standard used to determine the strength of block-type thermal insulation.
25.	ASTM D-3406	Standard Specification for Joint Sealant, Hot-Applied, Elastomeric-Type, for Portland Cement Concrete Pavements.
26.	ASTM D-3405	Standard Specification for Joint Sealants, Hot -Poured, For Concrete and Asphalt Pavements.
27.	ASTM D 638	Standard Test Method for Tensile Properties of Plastics.
28.	ASTM D 746	Standard Test Method for Brittleness Temperature of Plastics and Elastomers by Impact.
29.	ASTM D 747	Standard Test Method for Apparent Bending Modulus of Plastics by Means of a Cantilever Beam.
30.	ASTM D 792	Standard for Density and Specific Gravity of Plastics.
31.	ASTM B-370	Standard Specification for Copper Sheet and Strip for Building Construction.
32.	ASTM A-167	Standard Specification for Stainless and Heat-Resisting Chromium-Nickel Steel Plate, Sheet, and Strip.
33.	ASTM A-366	Standard Specification for Steel, Sheet, Carbon, Cold-Rolled, Commercial Quality.
34.	ASTM A-569	Standard Specification for Steel, Sheet and Strip, Carbon (0.15 Maximum Percent), Hot-Rolled, Commercial Quality.
35.	ASTM B-209	Standard Specification for Aluminum and Aluminum-Alloy Sheet and Plate.
36.	ASTM B-152-97(a)	Standard Specification for Copper, Sheet, Strip, Plate, and Rolled Bar.
37.	ASTM C 845	Standard Specification for Expansive Hydraulic Cement.
38.	ASTM A-421 or AASHTO M-204	Standard Specification for Uncoated Stress-Relieved Steel Wire for Prestressed Concrete.
39.	ASTM A-416 OR AASHTO M-203	Standard Specification for Low-Relaxation, Seven-Wire Steel Strand for Prestressed Concrete.
40.	ASTM C150	Standard Specification for Portland Cement.
41.	ASTM A370	Standard Test Methods and Definitions for Mechanical Testing of Steel Products.
42.	E290	Standard Test Methods for Bend Testing of Material for Ductility.
43.	ASTM A-615	Standard Specification for Deformed and Plain Carbon Steel Bars for Concrete Reinforcement.
44.	ASTM C-55-03	Standard Specification for Concrete Brick.
45.	ASTM-C-145-85	Specification for Solid Load-Bearing Concrete Masonry Units.
46.	ASTM C 150	Standard Specification for Portland Cement.
47.	ASTM C 33	Standard Specification for Concrete Aggregates.
48.	ASTM C 330	Standard Specification for Lightweight Aggregates for Structural Concrete.
49.	ASTM A 615	Standard Specification for Deformed and Plain Carbon-Steel Bars for Concrete Reinforcement.
50.	ASTM A 185	Standard Specification for Steel Welded Wire Reinforcement, Plain, for Concrete.
51.	ASTM A 820	Standard specification of steel fibers for Shotcrete.
52.	ASTM C 1116	Standard Specification for Fiber-Reinforced Concrete.
53.	ASTM C 1141	Standard Specification for Admixtures for Shotcrete.

54.	ASTM C 618	Standard Specification for Coal Fly Ash and Raw or Calcined Natural Pozzolan for Use in Concrete.
55.	ASTM C 989	Standard Specification for Ground Granulated Blast-Furnace Slag for Use in Concrete and Mortars
56.	ASTM C 1240	Standard Specification for Silica Fume Used in Cementitious Mixtures.
57.	ASTM C 171	Standard Specification for Sheet Materials for Curing Concrete.
58.	ASTM C 309	Standard Specification for Liquid Membrane-Forming Compounds for Curing Concrete.
59.	ASTM C 94	Standard Specification for Ready-Mixed Concrete.
60.	ASTM C 685	Standard Specification for Concrete Made by Volumetric Batching and Continuous Mixing.
61.	ASTM C-94	Standard Specification for Ready-Mixed Concrete.
62.	ASTM C 150	Standard Specification for Portland Cement.
63.	ASTM C 595	Standard Specification for Blended Hydraulic Cements.
64.	ASTM C 1157	Performance Specification for Hydraulic Cement.
65.	ASTM C-125	Standard Terminology Relating to Concrete and Concrete Aggregates.
BS		
66.	BS-1200	Specifications for building sands from natural sources.
67.	BS-12	Specification for Portland cement.
68.	BS- 3148	Methods of test for water for making concrete (including notes on the suitability of the water).
69.	BS 3921	Specification for clay bricks
70.		
ACI		
71.	ACI 304.2R	Placing concrete by pumping method.
72.	ACI 211.1	Standard Practice for Selecting Proportions for Normal, Heavyweight, and Mass Concrete.
73.	ACI 211.2	Standard Practice for Selecting Proportions for Structural Lightweight Concrete.
74.	ACI 347-R 2014	Guide to formwork for concrete.
75.	ACI 301	Specifications for Structural Concrete.
76.	ACI 116R	Cement and Concrete Terminologies
77.	ACI 207.2R	Report on Thermal and Volume Change Effects on Cracking of Mass Concrete.
78.	ACI 207.4R	Cooling and Insulating Systems for Mass Concrete.
79.	ACI 221 R	Guide for Use of Normal Weight and Heavyweight Aggregates in Concrete.
80.	ACI – 304R	Guide for Measuring, Mixing, Transporting, and Placing Concrete.

6.1 General

6.1.1 Description

This work shall consist of furnishing placing, finishing and curing concrete in structures in accordance with these specifications and conforming to the lines, grades, and dimensions shown on the plans. The work includes elements of structures constructed by cast-in-place and precast methods using either plain (unreinforced), reinforced, or pre-stressed concrete or any combination thereof.

6.1.2 Glossary

The following definitions apply to cement & concrete:

Abrasion damage:	Wearing a way of a surface by rubbing and friction.
Abrasion resistance:	Ability of a surface to resist being worn away by rubbing and friction.
Absolute specific gravity:	Ratio of the mass of a given volume of a solid or liquid at a stated temperature to the mass of an equal volume of gas-free distilled water at a stated temperature.
Absolute volume:	In the case of solids, the displacement volume of particles themselves, including their permeable and impermeable voids, but excluding space between particles; in the case of fluids, their volume.
Absorbed moisture:	Moisture that has entered a solid by absorption and has physical properties not substantially different from ordinary water at the same temperature and pressure.
Absorption:	The process by which a liquid is drawn into and tends to fill permeable pores in a porous solid; also, the increase in mass of a porous solid resulting from the penetration of a liquid into its permeable pores.
Accelerator:	A substance which, when added to concrete, mortar, or grout, increases the rate of hydration of the hydraulic cement, shortens the time of setting, or increases the rate of hardening, strength development, or both.
Adhesion:	The state in which two surfaces are held together by interfacial effects which may consist of molecular forces, interlock action, or both.
Adhesives:	The group of materials used to join or bond similar or dissimilar materials; for example, in concrete work, the epoxy resins.
Adjustment screw:	A levelling device or jack composed of a threaded screw and an adjusting handle; used for the vertical adjustment of shoring and formwork.

Admixture:	A material other than water, aggregates, hydraulic cement, and fiber reinforcement, used as an ingredient of concrete or mortar, and added to the batch immediately before or during its mixing.
Admixture, accelerating:	An admixture that causes an increase in the rate of hydration of the hydraulic cement, and thus shortens the time of setting, or increases the rate of strength development, or both.
Admixture, air-entraining:	An admixture that causes the development of a system of microscopic air bubbles in concrete, mortar, or cement paste during mixing.
Admixture, retarding:	Admixture that causes a decrease in the rate of hydration of the hydraulic cement, and lengthens the time of setting.
Admixture, Water-reducing:	An admixture that either increases slump of freshly mixed mortar or concrete without increasing water content or maintains slump within a reduced amount of water, the effect being due the factors other than air entrainment.
Admixture, water-reducing (high range):	A water reducing admixture capable of producing large water reduction or great flowability without causing undue set retardation or entrainment of air in mortar or concrete.
Absorbed water:	Water held on surfaces of a material by electrochemical forces and having physical properties substantially different from those of absorbed water or chemically combined water at the same temperature and pressure.
Adsorption:	Development (at the surface of either a liquid or solid) of a higher concentration of a substance than exists in the bulk of the medium; especially formation of one or more layers of molecules of gases, of dissolved substances, or of liquids at the surface of a solid (such as cement, cement paste, or aggregates), or of air entraining agents at the air-water interfaces; also the process by which a substance is adsorbed.
Agent:	A general term for a material that may be used either as an addition to cement or an admixture in concrete, e.g., an air-entraining agent.
Aggregate:	Granular material, such as sand, gravel, crushed stone, crushed hydraulic cement concrete, or iron blast furnace slag, used with a hydraulic-cementing medium to produce either concrete or mortar.
Aggregate, coarse:	Aggregate predominantly retained on the 4.75mm (No.4) sieve or that portion retained on the 4.75mm (No.4) sieve.
Aggregate, crusher-run:	Aggregate that has been mechanically broken and has not been subjected to subsequent screening.
Aggregate, dense-graded:	Aggregates graded to produce low void content and maximum weight when compacted.

Aggregate, fine:	Aggregate passing the 9.5mm (3/8") sieve and almost entirely passing the 4.75mm (No.4) sieve and predominantly retained on the 75- μ m (No.200) sieve; or that portion passing the 4.75mm (No.4) sieve and predominantly retained on the 75- μ m (No.200) sieve.
Aggregate, gap-graded:	Aggregate so graded that certain intermediate sizes are substantially absent.
Aggregate, heavyweight:	Aggregate of high density, such as barite, magnetite, hematite, limonite, iron, or steel, used in heavy weight concrete.
Aggregate, lightweight:	Aggregate of low density, such as (a) expanded or sintered clay, shale, slate, diatomaceous shale, perlite, vermiculite, or slag (b) natural pumice, scoria, volcanic cinders, tuff, and diatomite, (c) sintered fly ash or industrial cinders, used in lightweight concrete.
Aggregate, normal weight:	Aggregate that is neither heavyweight nor lightweight.
Aggregate, open-graded:	Aggregate in which the voids are relatively large when the aggregate is compacted.
Aggregate, reactive:	Aggregate containing substances capable of reacting chemically with the products of solution or hydration of the Portland cement in concrete or mortar under ordinary conditions of exposure, resulting in some cases in harmful expansion, cracking, or staining.
Aggregate, refractory:	Aggregate having refractory properties which, when bound together into a conglomerate mass by a matrix, forms a refractory body.
Aggregate, single-sized:	Aggregate in which a major portion of the particles are in a narrow size range.
Aggregate, well-graded:	Aggregate having a particle size distribution that produces maximum density, i.e., minimum void space.
Aggregate blending:	The process of intermixing two or more aggregates to produce a different set of properties; generally, but not exclusively, to improve grading.
Aggregate interlock:	The effect of portions of aggregate particles from one side of a joint or crack in concrete protruding into recesses in the other side of the joint or crack so as to transfer load in shear, and maintain alignment.
Agitator:	A device for maintaining plasticity and preventing segregation of mixed concrete by agitation.
Aids, grinding:	Materials used to expedite the process of grinding by eliminating ball coating or by dispersing the finely ground product, or both.

Air, accidental:	Air voids in concrete which are not purposely entrained and which are significantly larger and less useful than those of entrained air, 1mm or larger in size.
Air content:	The volume of air voids in cement paste, mortar, or concrete, exclusive of pore space in aggregate particles, usually expressed as a percentage of total volume of the paste, mortar, or concrete.
Air entraining:	The capability of a material or process to develop a system of minute bubbles of air in cement paste, mortar, or concrete during mixing.
Air-entraining agent:	An addition for hydraulic cement; also, an admixture for concrete or mortar which causes entrained air to be incorporated in the concrete or mortar during mixing, usually to increase its workability and frost resistance.
Air permeability test:	A procedure for measuring the fineness of powder materials such as Portland cement.
Air void:	A space in cement paste, mortar, or concrete filled with air; an entrapped air void is characteristically 1mm or more in size and irregular in shape; an entrained air void is typically between 10 mm and 1mm in diameter and spherical or nearly so.
Alkali:	Salts of alkali metals, principally sodium and potassium; specially sodium and potassium occurring in constituents of concrete and mortar, usually expressed in chemical analyses as the oxides Na ₂ O and K ₂ O.
Alkali aggregate reaction:	Chemical reaction in either mortar or concrete between alkalis (sodium and potassium) from Portland cement or other sources and certain constituents of some aggregates; under certain conditions, deleterious expansion of concrete or mortar may result.
Alkali carbonate rock reaction:	The reaction between the alkalis (sodium and potassium) in Portland cement and certain carbonate rocks, particularly calcitic dolomite and dolomitic limestones, present in some aggregates; the products of the reaction may cause abnormal expansion and cracking of concrete in service.
Alkali reactivity (of aggregate):	Susceptibility of aggregate to alkali-aggregate reaction.
Alkali-silica reaction:	The reaction between the alkalis (sodium and potassium) in Portland cement and certain siliceous rocks or minerals, such as opaline chert, strained quartz, and acidic volcanic glass, present in some aggregates; the products of the reaction may cause abnormal expansion and cracking of concrete in service.
Allowable stress:	Maximum permissible stress used in design of members of a structure and based on a factor of safety against rupture or yielding of any type.

Anchor:	In prestressed concrete, to lock the stressed tendon in position so that it will retain stressed condition in precast concrete construction, to attach the precast units to the building frame; in slabs on grade or walls, to fasten to rock or adjacent structures to prevent movement of the slab or wall with respect to the foundation, adjacent structure, or rock.
Anchor bolt:	A metal bolt or stud, headed or threaded, either cast in place, grouted in place, or drilled into finished concrete, used to hold various structural members or embedment in the concrete, and to resist shear, tension, and vibration loading from various sources such as wind, machine vibration etc.; known also as a hold-down bolt or a foundation bolt.
Anchorage:	In post-tensioning, a device used to anchor the tendon to the concrete member; in pre-tensioning, a device used to maintain the elongation of a tendon during the time interval between stressing and release; in precast concrete construction, the devices for attaching precast units to the building frame; in slab or wall construction, the device used to anchor the slab or wall to the foundation, rock, or adjacent structure.
Anchorage bond stress:	The bar forces divided by the product of the bar perimeter or perimeters and the embedment length.
Anchorage deformation or seating:	The loss of elongation or stress in the tendons of prestressed concrete due to the deformation or seating of the anchorage when the prestressing force is transferred from the jack to the anchorage; known also as anchorage loss.
Anchorage zone:	In post-tensioning, the region adjacent to the anchorage subjected to secondary stresses resulting from the distribution of the prestressing force; in pre-tensioning, the region in which the transfer bond stresses are developed.
Angular aggregate:	Aggregate particle which possess well-defined edges formed at the intersection of roughly planar faces.
Average bond stress:	The force in a bar divided by the product of the perimeter and the development length of the bar.
Back plastering:	Plaster applied to one face of a lath system following application and subsequent hardening of plaster applied to the opposite face.
Bacterial corrosion:	The destruction of a material by chemical processes brought about by the activity of certain bacteria which produce substances such as hydrogen sulfide, ammonia, and sulphuric acid.

Bar mat:	An assembly of steel reinforcement composed of two or more layers of bars placed at angles to each other and secured together either by welding or tying.
Bar schedule:	A list of the reinforcement, showing the shape, number, size, and dimensions of every different element required for a structure or a portion of a structure.
Bar spacing:	The distance between parallel reinforcing bars, measured center to center of the bars perpendicular to their longitudinal axes.
Bar support:	Hardware used to support or hold reinforcing bars in proper position to prevent displacement before and during concreting.
Barrel-vault roof:	A thin concrete roof in the form of a part of a cylinder.
Base course:	A layer of specified select material of planned thickness constructed on the subgrade or subbase of a pavement to serve one or more functions such as distributing loads, providing drainage, or minimizing frost action; also, the lowest course of masonry in a wall or pier.
Batch box:	Container of known volume used for measuring constituents of a batch of either concrete or mortar in proper proportions.
Batch weights:	The weight of the various materials (cement, water, the several sizes of aggregate, and admixtures if used), which compose a batch of concrete.
Batched water:	The mixing water added by a batcher to a cementitious mixture either before or during the initial stages of mixing.
Manual batcher:	A batcher equipped with gates or valves that are operated manually, with or without supplementary power (pneumatic, hydraulic, or electrical), the accuracy of the weighing operation being depended on the operator's observation of the scale.
Semiautomatic batcher:	A batcher equipped with gates or valves that are separately opened manually to allow the material to be weighed but which are closed automatically when the designated weight of each material has been reached.
Automatic batcher:	A batcher equipped with gates or valves which, when actuated by a single starter switch, will open automatically at the start of the weighing operation of each material and closed automatically when the designated weight of each material has been reached, interlocked in such a manner that: (a) the charging mechanism cannot be opened until the scale has returned to zero; (b) the charging mechanism cannot be opened if the discharge mechanism is open; (c) the discharge

mechanism cannot be opened if the charging mechanism is open; (d) the discharge mechanism cannot be opened until the designated weight has been reached within the allowable tolerance; and (e) if different kinds of aggregates or different kinds of cements are weighed cumulatively in a single batcher, interlocked sequential controls are provided.

Batching:	Weighing or volumetrically measuring and introducing into the mixer the ingredients for a batch or either concrete or mortar.
Batten:	A narrow strip of wood placed over the vertical joint of sheeting or paneling; also used to hold several boards together.
Bay:	The space, in plan, between the center lines of adjacent piers, mullions, or columns; a small, well-defined area of concrete laid at one time in the course of placing large areas such as floor; pavements, or runways.
Beam:	A structural member subjected to axial load and flexure but primarily to flexure; also, the graduated horizontal bar of a weighing scale on which the balancing poises ride.
Beam bottom:	Soffit or bottom form for a beam.
Beam-column:	A structural member subjected to axial load and flexure forces but primarily axial load.
Beam form:	A retainer or mold so erected as to give the necessary shape, support, and finish to a concrete beam.
Beam from clamp:	Any of various types of tying or fastening units used to hold the sides of beam forms.
Beam hanger:	A wire, strap, or other hardware device that supports formwork from structural members.
Beam pocket:	Opening left in a vertical member in which a beam is to rest; also, an opening in the column or girder from where forms for an intersecting beam will be framed.
Beam test:	A method of measuring the flexural strength (modulus of rupture) of concrete by testing a standard unreinforced beam.
Bearing stratum:	The soil or rock stratum on which a concrete footing, or mat bears or which carries the load transferred to it by a concrete pile, caisson, or similar deep foundation unit.
Bending moment:	The bending effect at any section of a structural element; it is equal to the algebraic sum of the moments of the vertical and horizontal forces, with respect to the centroidal axis of a member, acting on a free body of the member.

- Bending moment diagram:** A graphical representation of the variation of bending moment along the length of the member for a given stationary system of load.
- Bent bar:** A reinforcing bar bent to a prescribed shape.
- Binders:** Cementing materials, either hydrated cements or products of cement or lime and reactive siliceous materials; the kinds of cement and curing conditions govern the general kind of binder formed; also, materials such as asphalt, resins, and other materials forming the matrix of concrete, mortars, and sanded grouts.
- Blast-furnace slag:** The non-metallic product, consisting essentially of silicates and aluminosilicates of calcium and other bases, that is developed in a molten condition simultaneously with iron in a blast furnace.
- Bleeding capacity:** The ratio of volume of water released by bleeding to the volume of paste or mortar.
- Bleeding rate:** The rate at which water is released from a paste or mortar by bleeding.
- Blemish:** Any superficial defect that causes visible variation from a consistently smooth and uniformly colored surface of hardened concrete.
- Blinding:** The application of a layer of weak concrete or other suitable material to reduce surface voids, or to provide a clean, dry working surface; also, the filling or plugging of the openings in a screen or sieve by the material being separated.
- Blistering:** The irregular raising of a thin layer at the surface of placed mortar or concrete during or soon after completion of the finishing operation, or in the case of pipe after spinning; also bulging of the finish plaster coat as it separates and draws away from the base coat.
- Block beam:** A flexural member composed of individual blocks which are joined together by prestressing.
- Bond:** Adhesion and grip of concrete or mortar to reinforcement or to other surfaces against which it is placed, including friction due to shrinkage and longitudinal shear in the concrete engaged by the bar deformations; the adhesion of cement paste to aggregate; adherence between plaster coats or between plaster and a sub stratum produced by adhesive or cohesive properties of plaster or supplemental materials.

Bond area:	The nominal area of interface between two elements across which adhesion develops or may develop, as between concrete and reinforcing steel.
Bond breaker:	A material used to prevent adhesion of newly placed concrete and the substrate.
Bond prevention:	Measures taken to prevent adhesion of concrete or mortar to surfaces against which it is placed.
Bond strength:	Resistance to separation of mortar and concrete from reinforcing and other materials with which it is in contact; a collective expression for all forces such as adhesion, friction due to shrinkage, and longitudinal shear in the concrete engaged by the bar deformations that resist separation.
Bond stress:	The force of adhesion per unit area of contact between two bonded surfaces such as concrete and reinforcing steel or any other material such as foundation rock; shear stress at the surface of a reinforcing bar, preventing relative movement between the bar and the surrounding concrete.
Bonding layer:	A layer of mortar, usually 1/8 to 1/2 inch (3 to 13 mm) thick, which is spread on a moist and prepared, hardened concrete surface prior to placing fresh concrete.
Brace:	A structural member used to provide lateral support for another member, generally for the purpose of assuring stability or of resisting lateral loads.
Bracket:	An overhanging member projecting from a wall or other body to support weight acting outside the wall, or similar piece to strengthen an angle.
Briquette:	A molded specimen of mortar with enlarged extremities and reduced center having a cross section of definite area, used for measurement of tensile strength.
Broom finish:	The surface texture obtained by striking a broom over freshly placed concrete.
Brushed surface:	A sandy texture obtained by brushing the surface of freshly placed or slightly hardened concrete with a stiff brush for architectural effect or, in pavement, to increase skid resistance.
Buckling:	Failure by lateral or torsional instability of a structural member, occurring with stresses below the yield or ultimate value.
Bulk density:	The mass of a material (including solid particles and any contained water) per unit volume including voids.

Bulking:	Increase in the bulk volume of a quantity of sand in a moist condition over the volume of the same quantity dry or completely inundated.
Bulking factor:	Ratio of the volume of moist sand to the volume of the sand when dry.
Bundled bars:	A group of not more than four parallel reinforcing bars in contact with each other, usually tied together.
Butt joint:	A plain square joint between two members.
Calcareous:	Containing calcium carbonate or, less generally, containing the element calcium.
Calcite:	A mineral having the composition calcium carbonate (CaCO_3) and a specific crystal structure; the principal constituent of limestone, chalk, and marble; used as a major constituent in the manufacture of Portland cement.
Camber:	A deflection that is intentionally built into a structural element or form to improve appearance or to nullify the deflection of the element under the effects of loads, shrinkage, and creep.
Cap:	A smooth, plane surface of suitable material bonded to the bearing surfaces of test specimens to insure uniform distribution of load during strength testing.
Cap cables:	Short cables (tendons) introduced to prestress the zone of negative bending only.
Capillarity:	The movement of a liquid in the interstices of soil or other porous material due to surface tension.
Carbonation:	Reaction between carbon dioxide and a hydroxide or oxide to form a carbonate, especially in cement paste, mortar, or concrete; the reaction with calcium compounds to produce calcium carbonate.
Cast-in-place:	Mortar or concrete which is deposited in the place where it is required to harden as part of the structure, as opposed to precast concrete.
Catalyst:	A substance that initiates a chemical reaction and enables it to proceed under milder conditions than otherwise required and which does not, itself, alter or enter into the reaction.
Catwalk:	A narrow elevated walkway.
Cellular construction:	A method of constructing concrete elements in which part of the interior concrete is replaced by voids.

Cement, bulk:	Cement that is transported and delivered in bulk (usually in specially constructed vehicles) instead of in bags.
Cement, low heat:	A Portland cement that produces limited generation of heat during setting.
Cement, Portland:	A hydraulic cement produced by pulverizing Portland cement clinker and usually containing calcium sulfate.
Cement, Portland blast furnace slag:	A hydraulic cement consisting of an intimately inter ground mixture of Portland-cement clinker and granulated blast-furnace slag or an intimate and uniform blend of Portland cement and fine granulated blast-furnace slag in which the amount of the slag constituent is within specified limits.
Cement, Portland pozzolan:	A hydraulic cement consisting of an intimate and uniform blend of Portland cement or Portland blast furnace slag cement and fine pozzolan produced by inter grinding Portland-cement clinker and pozzolan, by blending Portland cement or Portland blast-furnace slag cement and finely divided pozzolan, or a combination of inter grinding and blending, in which the pozzolan constituent is within specified limit.
Cement, slag:	A hydraulic cement consisting mostly of an intimate and uniform blend of granulated blast-furnace slag and hydrated lime in which the slag constituent is more than a specified minimum percentage.
Cement, sulfate resistant:	Portland cement, low in tricalcium aluminate, to reduce susceptibility of concrete to attack by dissolved sulfates in water or soils.
Cement, Super sulphated:	A hydraulic cement made by intimately grinding a mixture of granulated blast-furnace slag, calcium sulfate and a small amount of lime, cement, or cement clinker, so named because the equivalent content of sulfate exceeds that for Portland blast furnace slag cement.
Cement, white:	Portland cement which hydrates to a white paste; made from raw materials of low iron content the clinker for which is fired by a reducing flame.
Cement aggregate ratio:	The ratio of cement to total aggregate, either by mass or volume.
Cement content:	Quantity of cement contained in a unit volume of concrete or mortar, preferably expressed as weight.
Cement gel:	The colloidal material that makes up the major portion of the porous mass of which mature hydrated cement paste is composed.

Cement gun:	A machine for pneumatic placement of mortar or small aggregate concrete; in the “Dry Gun”, water from a separate hose meets the dry material at the nozzle of the gun; with the “Wet Gun”, the delivery hose conveys the premixed mortar or concrete.
Cement paint:	A paint consisting generally of white Portland cement and water, pigments, hydrated lime, water repellents, or hygroscopic salts.
Cement paste:	Constituent of concrete consisting of cement and water.
Centering:	Falsework used in the construction of arches, shells, space structures, or any continuous structure where the entire falsework is lowered (struck or decentered) as a unit.
Chalking:	Formation of a loose powder resulting from the disintegration of the surface of concrete or of applied coating, such as cement paint.
Chamfer:	Either a beveled edge or corner formed in concrete work by means of a chamfer strip.
Chipping:	Treatment of a hardened concrete surface by chiseling.
Chute:	A sloping trough or tube for conducting concrete, cement, aggregate, or other free flowing materials from a higher to a lower point.
Cleanout:	An opening in the forms for removal of refuse, to be closed before the concrete is placed; a port in tanks, bins, or other receptacles for inspection and cleaning.
Cleanup:	Treatment of horizontal construction joints to remove all surface material and contamination down to a condition of cleanness corresponding to that of a freshly broken surface of concrete.
Cleat:	Small board used to connect formwork members or used as a brace.
Clinker:	A partially fused product of a kiln, which is ground to make cement; also, other vitrified or burnt material.
Coarse aggregate factor:	The ratio, expressed as a decimal, of the amount (mass or solid volume) of coarse aggregate in a unit volume of well-proportioned concrete to the amount of dry rodded coarse aggregate compacted into the same volume.
Coefficient of thermal expansion:	Change in linear dimension per unit length or change in volume per unit volume per degree of temperature change.

Coefficient of variation:	The standard deviation expressed as a percentage of the average.
Cold-worked steel reinforcement:	Steel bars or wires which have been rolled, twisted, or drawn at normal ambient temperatures.
Colloid:	A substance that is in a state of division preventing passage through a semipermeable membrane, consisting of particles ranging from 0.1 to 0.001 μm in diameter.
Column:	A member used primarily to support axial compression loads and with a height of at least three times its least lateral dimension.
Column, short:	A column whose load capacity is limited by strength rather than buckling; a column which is customarily so stocky and sufficiently restrained that at least 95 percent of the cross-sectional strength can be developed.
Column, slender:	A column whose load capacity is reduced by the increased eccentricity caused by secondary deflection moments.
Column capital:	An enlargement of a column below a slab intended to increase the shearing resistance.
Column clamp:	Any of various types of tying or fastening units to hold column form sides together.
Column strip:	The portion of a flat slab over the columns and consisting of the two adjacent quarter panels on each side of the column center line.
Combined footing:	A structural unit or assembly of units supporting more than one column.
Compacting factor:	The ratio obtained by dividing the observed mass of concrete, which fills a container of standard size and shape when allowed to fall into it under standard conditions of test, by the mass of fully compacted concrete which fills the same container.
Composite column:	A concrete compression member reinforced longitudinally with structural steel shapes, pipe, or tubing with or without longitudinal reinforcing bars.
Composite construction:	A type of construction using members produced by combining different materials (e.g. concrete and structural steel) members produced by combining cast in place and precast concrete, or cast-in-place concrete elements constructed in separate placement but so interconnected that the combined components act together as a single member and respond to loads as a unit.

Compound, joint-sealing:	An impervious material used to fill joints in pavements or structures.
Compound, “waterproofing”:	Material used to impart water repellency to a structure or a constructional unit.
Compression flange:	The widened portion of an I, T, or similar cross-section beam which is shortened or compressed by bending under normal loads, such as the horizontal portion of the cross section of a simple span T-beam.
Compression member:	Any member in which the primary stress is longitudinal compression.
Compression reinforcement:	Reinforcement designed to carry compressive stresses.
Compression test:	Test made on a test specimen of mortar or concrete to determine the compressive strength.
Compressive strength:	The measured maximum resistance of a concrete or mortar specimen to axial compressive loading; expressed as force per unit cross-sectional area; or the specified resistance used in design calculations.
Compressive strength average:	The average compressive strength of a given class or strength level of concrete; defined as average compressive strength required to statistically meet a designated specific strength.
Concentric tendons:	Tendons following line coincident with the gravity axis of the prestressed concrete member.
Concrete, backfill:	Non-structural concrete used to correct over excavation, fill excavated pockets in rock, or prepare a surface to receive structural concrete.
Concrete, cellular:	A lightweight product consisting of Portland cement, cement-silica, cement-pozzolan, lime-pozzolan, or lime-silica pastes, or pastes containing blends of these ingredients and having a homogeneous void or cell structure, attained with gas-forming chemicals or foaming agent (for cellular concretes containing binder ingredients other than, or in addition to, Portland cement, autoclave curing is usually employed).
Concrete, exposed:	Concrete surfaces formed so as to yield an acceptable texture and finish for permanent exposure to view.
Concrete, fair face:	A concrete surface which, on completion of the forming process, requires no further (concrete) treatment other than curing.
Concrete, fiber reinforced:	Concrete containing dispersed, randomly oriented fibers.

Concrete, field:	Concrete delivered or mixed, placed, and cured on the job site.
Concrete, foamed:	Concrete may very light and cellular by the addition of a prepared foam or by generation of gas within the unhardened mixture.
Concrete, gap graded:	Concrete containing a gap-graded aggregate.
Concrete, green:	Concrete which has set but not appreciably hardened.
Concrete, heat resistant:	Any concrete that will not disintegrate when exposed to constant or cyclic heating at any temperature below which a ceramic bond is formed.
Concrete, heavyweight:	Concrete of substantially higher density than that made using normal-weight aggregates, usually obtained by use of heavyweight aggregates and used especially for radiation shielding.
Concrete, high-early strength:	Concrete, which, through the use of high-early-strength cement or admixtures, attains a given level of strength earlier than normal concrete.
Concrete, high-strength:	Concrete that has a specified compressive strength for design of 6000 psi (41 MPa) or greater.
Concrete, in situ:	Concrete that is deposited and allowed to harden in the place where it is required to be in the completed structure, as opposed to precast concrete.
Concrete, insulating:	Concrete having low thermal conductivity; used as thermal insulation.
Concrete, lean:	Concrete of low cement content.
Concrete, lightweight:	Concrete of substantially lower density than that made using aggregate of normal density
Concrete, mass:	Any volume of concrete with dimensions large enough to require that measures be taken to cope with generation of heat from hydration of the cement and attendant volume change to minimize cracking.
Concrete, monolithic:	Concrete cast with no joints other than construction joints.
Concrete, Normal weight:	Concrete having a unit weight of approximately 150 lb. per cu ft (2400 kg/cu m) made with normal weight aggregates.
Concrete, plain:	Concrete without reinforcement; reinforced concrete that does not conform to the definition of reinforced concrete; also used loosely to designate concrete containing no admixture and prepared without special treatment.
Concrete, polymer:	Concrete in which an organic polymer serves as the binder; also known as resin concrete; sometimes erroneously employed to

designate hydraulic cement mortars or concrete in which part or all of the mixing water is replaced by an aqueous dispersion of a thermoplastic copolymer.

Concrete, Polymer cement:	A mixture of water, hydraulic cement, aggregate, and a monomer or polymer; polymerized in place when a monomer is used.
Concrete, precast:	Concrete cast elsewhere than its final position.
Concrete (mortar, grout), preshrunk:	(1) Concrete that has been mixed for a short period in a stationary mixer before being transferred to a transit mixer. (2) grout, mortar, or concrete that has been mixed 1 to 3 hours before placing in order to reduce shrinkage during hardening.
Concrete, prestressed:	Concrete in which internal stresses of such magnitude and distribution are introduced that the tensile stresses resulting from the service loads are counteracted to a desired degree; in reinforced concrete the prestress is commonly introduced by tensioning the tendons.
Concrete, pumped:	Concrete which is transported through hose or pipe by means of a pump.
Concrete, reinforced:	Concrete containing adequate reinforcement (prestressed or not prestressed) and designed on the assumption that the two materials act together in resisting forces.
Concrete, siliceous aggregate:	Concrete made with normal-weight aggregates having constituents composed mainly of silica or silicates.
Concrete, spun:	Concrete compacted by centrifugal action, e.g., in the manufacture of pipe and poles.
Concrete, structural:	Concrete used to carry structural load or to form an integral part of a structure; concrete of a quality specified for structural use.
Concrete, structural lightweight:	Structural concrete made with lightweight aggregate; having an air-dry unit weight of not more than 115 lb./ft ³ (1850 kg/m ³) and a 28-day compressive strength or more than 2500 psi (17.24 MPa)
Concrete, vibrated:	Concrete consolidated by vibration during and after placing.
Concrete paver:	(1) A concrete mixer, usually mounted on crawler tracks, which mixes and places concrete pavement on the subgrade. (2) Precast concrete paving brick.
Concrete vibrating machine:	A machine which consolidates a layer of freshly mixed concrete by vibration.
Confined region:	Region with transverse reinforcement within beam column joints.

Consistency:	The relative mobility or ability of freshly mixed concrete or mortar to flow; the usual measurements are slump for concrete, flow for mortar or grout, and penetration resistance for neat cement paste.
Consistency factor:	A measure of grout fluidity, roughly analogous to viscosity, which describes the ease with which grout may be pumped into pores or fissures; usually a laboratory measurement in which consistency is reported in degrees of rotation of a torque viscosimeter in a specimen of grout.
Consolidation:	The process of inducing a closer arrangement of the solid particles in freshly mixed concrete or mortar, during placement by the reduction of voids; usually by vibration, centrifugation, rodding, tamping, or some combination of these actions; also applicable to similar manipulation of other cementitious mixtures, soils, aggregates, or the like.
Construction joint:	The surface where two successive placements of concrete meet, across which it may be desirable to achieve bond and through which reinforcement may be continuous.
Construction load:	The loads to which a permanent or temporary structure is subjected during construction.
Contact pressure:	Pressure acting at and perpendicular to the contact area between footing and soil, produced by the weight of the footing and all forces acting on it.
Contact splice:	A means of connecting reinforcing bars in which the bars are lapped and in direct contact.
Continuous footing:	A combined footing of prismatic or truncated shape, supporting two or more columns in a row.
Continuous grading:	A particle size distribution in which all intermediate size fractions are present, as opposed to gap-grading.
Continuous mixer:	A mixer into which the ingredients of the mixture are fed without stopping, and from which the mixed product is discharged in a continuous stream.
Continuous slab or beam:	A slab or beam which extends as a unit over three or more supports in a given direction.
Continuously reinforced pavement:	A pavement with continuous longitudinal steel reinforcement and no intermediate transverse expansion or contraction joints.
Contraction joint:	Formed, sawed, or tooled groove in a concrete structure to create a weakened plane and regulate the location of cracking resulting from the dimensional change of different parts of the structure.

Control factor:	The rate of minimum compressive strength to the average compressive strength.
Conveyor:	A device for moving materials; usually a continuous belt, an articulated system of buckets, a confined screw, or a pipe through which material is moved by air or water.
Coping:	The material or units used to form a cap or finish on top of a wall, pier, pilaster, or chimney.
Corbel:	A projection from the face of a beam, girder, column, or wall used as a beam seat or a decoration.
Core:	(1) The soil material enclosed within a tubular pile after driving (it may be replaced with concrete). (2) The mandrel used for driving casings for cast-in-place piles. (3) A structural shape used to internally reinforce a drilled-in-caisson. (4) A cylindrical sample of hardened concrete or rock obtained by means of a core drill. (5) The molded open space in a concrete masonry unit or precast concrete unit.
Core test:	Compression test on a concrete sample cut from hardened concrete by means of a core drill.
Coring:	The act of obtaining cores from concrete structures or rock foundations.
Corner reinforcement:	Metal reinforcement for plaster at re-entrant corners to provide continuity between two intersecting planes; or concrete reinforcement used at wall intersections or near corners of square or rectangular openings in walls, slabs, or beams.
Cotton mats:	Cotton-filled quilts fabricated for use as a water retaining covering in curing concrete surfaces.
Coupler:	(1) A device for connecting reinforcing bars or prestressing tendons end to end. (2) A device for locking together the component parts of a tubular metal scaffold (also known as a clamp). (3) Internal threaded device for joining reinforcing bars with matching threaded ends for the purpose of providing transfer of either axial compression or axial tension or both from one bar to the other.
Coupling pin:	An insert device used to connect lifts or tiers or formwork scaffolding vertically.
Coupling sleeve:	Device fitting over the ends of two reinforcing bars for the eventual purpose of providing transfer of either axial compression or axial tension or both from one bar to the other.
Cover:	In reinforced concrete, the least distance between the surface of the reinforcement and the outer surface of the concrete.

Cracking load:	The load which causes tensile stress in a member to exceed the tensile strength of the concrete.
Craze cracks:	Development of shallow cracks at closely spaced but irregular intervals on the surface of plaster, cement past, mortar or concrete.
Creep:	Time-dependent deformation due to sustained load.
Creep basic:	Creep that occurs without migration of moisture to or from the concrete.
Critical saturation:	A condition describing the degree of filling by freezable water of a pore space in cement paste or aggregate that affects the response to freezing; usually taken to be 91.7 percent because of the 9 percent increase in volume of water undergoing the change of state to ice.
Curing:	The maintenance of a satisfactory moisture content and temperature in concrete during its early stages so that desired properties may develop.
Curing blanket:	A built-up covering of sacks, matting, hessian, straw, waterproof paper, or other suitable material placed over freshly finished concrete.
Curing compound:	A liquid that can be applied as a coating to the surface of newly placed concrete to retard the loss of water or, in the case of pigmented compounds, also to reflect heat so as to provide an opportunity for the concrete to develop its properties in a favorable temperature and moisture environment.
Curling:	The distortion of an originally essentially linear or planar member into a curved shape such as the warping of a slab due to creep or to differences in temperature or moisture content in the zones adjacent to its opposite faces.
Damp proofing:	Treatment of concrete or mortar to retard the passage or absorption of water, or water vapor, either by application of a suitable coating to exposed surfaces, or by use of a suitable admixture or treated cement, or by use of pre-formed films such as polyethylene sheet under slabs on grade.
Dead end:	In the stressing of a tendon from one end only, the end opposite that to which the load is applied.
Dead-end anchorage:	The anchorage at that end of a tendon which is opposite the jacking end.
Dead load:	A constant load that in structures is due to the mass of the members, the supported structure, and permanent attachments or accessories.

Deck:	The form on which concrete for a slab is placed, also the floor or roof slab itself.
Deformation, elastic:	Deformation proportional to the applied stress.
Deformation, inelastic:	Deformation not proportional to the applied stress.
Deformation, time dependent:	Deformation resulting from effects such as autogenous volume change, thermal contraction or expansion, creep, shrinkage, and swelling, each of which is a function of time.
Deformed bar:	A reinforcing bar with a manufactured pattern of surface ridges intended to prevent slip when the bar is embedded in concrete.
Deformed plate:	A flat piece of metal, thicker than ¼" (6mm), having horizontal deformations or corrugations; used in construction to form a vertical joint and provide a mechanical interlock between adjacent section.
Deformed reinforcement:	Metal bars, wire, or fabric with a manufactured pattern of surface ridges which provide a locking anchorage with surrounding concrete.
Density (dry):	The mass per unit volume of a dry substance at a stated temperature.
Deterioration:	(1) Physical manifestation of failure of a material (e.g. cracking, delamination, flaking, pitting, scaling, spalling, staining) caused by environmental or internal autogenous influences on rock and hardened concrete as well as other materials; (2) Decomposition of material during either testing or exposure to service.
Detritus:	Loose material produced by the disintegration of rocks through geological agencies or processes simulating those of nature.
Development length:	The embedment length required to develop the design strength of the reinforcement at a critical section; formerly called bond length.
Diagonal crack:	In a flexural member, an inclined crack caused by shear stress, usually at about 45 deg to the axis; or a crack in a slab, not parallel to either the lateral or longitudinal directions.
Diagonal tension:	The principal tensile stress resulting from the combination of normal and shear stresses acting upon a structural element.
Dilation:	An expansion of concrete during cooling or freezing generally calculated as the maximum deviation from the normal thermal contraction predicted from the length change temperature curve or length change-time curve established at temperatures before initial freezing.
Diluent:	A substance, liquid or solid, mixed with the active constituents of a formulation to increase the bulk or lower the concentration.

Distribution bar reinforcement:	Small diameter bars, usually at right angles to the main reinforcement, intended to spread a concentrated load on a slab and to prevent cracking.
Divider strips:	In terrazzo work, nonferrous metal or plastic strip of different thicknesses, usually embedded from 5/8 to 1¼" (10 to 40mm), used to form panels in the topping.
Double-tee beam:	A precast concrete member composed of two stems and a combined top flange, commonly used as a beam.
Dowel:	(1) A steel pin, commonly a plain round steel bar, which extends into adjoining portions of a concrete construction, as at a joint in a pavement slab, so as to transfer shear loads; (2) A deformed reinforcing bar intended to transmit tension, compression, or shear through a construction joint.
Dried strength:	The compressive or flexural strength of refractory concrete determined within 3 hrs. after first drying in an oven at 220 to 230 F (105 to 110 C) for a specified time.
Drip:	A transverse groove in the underside of a projecting piece of wood, stone, or concrete to prevent water from flowing back to a wall.
Drop chute:	A device used to confine or to direct the flow of a falling stream of fresh concrete (1) drop chute, articulated – a device consisting of a succession of tapered metal cylinders so designed that the lower end of each cylinder fits into the upper end of the one below (2) drop chute, flexible – a device consisting of a heavy rubberized canvas or plastic collapsible tube.
Early strength:	Strength of concrete or mortar usually as developed at various times during the first 72 hrs. after placement.
Early stiffening:	The early development of an abnormal reduction in the working characteristics of a hydraulic-cement paste, mortar, or concrete, which may be further described as false set, quick set, or flash set.
Edge-bar reinforcement:	Tension steel sometimes used to strengthen otherwise inadequate edges in a slab, without resorting to edge thickening.
Effective depth:	Depth of a beam or slab section measured from the compression face to the centroid of the tensile reinforcement.
Effective flange width:	Width of slab adjoining a beam stem where the slab is assumed to function as the flange element of a T-beam section.
Effective width of slab:	That part of the width of a slab taken into account when designing T- or L-beams.

Efflorescence:	A deposit of salts, usually white, formed on a surface, the substance having emerged in solution from within either concrete or masonry and subsequently been precipitated by evaporation.
Elastic design:	A method of analysis in which the design of a member is based on a linear stress-strain relationship and corresponding limiting elastic properties of the material.
Elastic limit:	The limit of stress beyond which the strain is not wholly recoverable.
Elastic loss:	In prestressed concrete, the reduction in prestressing load resulting from the elastic shortening of the member.
Elasticity:	That property of a material by virtue of which it tends to recover its original size and shape after deformation.
Embedment length:	The length of embedded reinforcement provided beyond a critical section.
Embedment length equivalent:	The length of embedded reinforcement which can develop the same stress as that which can be developed by a hook or mechanical anchorage.
Enclosure wall:	A non-load-bearing wall intended only to enclose space.
Evaporation retardant:	A long-chain organic material such as acetyl alcohol which when spread on a water film on the surface of concrete retards the evaporation of bleed water.
Expansion joint:	(1) A separation provided between adjoining parts of structure to allow movement where expansion is likely to exceed contraction. (2) A separation between pavement slabs on grade, filled with a compressible filler material. (3) An isolation joint intended to allow independent movement adjoining parts.
Exterior panel:	In a flat slab, a panel having at least one edge which is not in common with another panel.
Factored load:	Load, multiplied by appropriate load factors, used to proportion members by the strength design method.
False work:	The temporary structure erected to support work in the process of construction; composed of shoring or vertical posting, formwork for beams and slabs, and lateral bracing.
Fascia:	A flat member or band at the surface of a building or the edge beam of a bridge; also, exposed eave of a building
Fatigue:	The weakening of a material caused by repeated or alternating loads.

Fatigue failure:	The phenomenon of rupture of material, when subjected to repeated loadings, at a stress substantially less than the static strength.
Fatigue strength:	The greatest stress which can be sustained for a given number of stress cycles without failure.
Faulting:	Differential vertical displacement of a slab or other member adjacent to a joint or crack.
Field-cured cylinders:	Test cylinders that are left at the job-site for curing as nearly as practicable in the same manner as the concrete in the structure to indicate when supporting forms may be removed, additional construction loads may be imposed, or the structure may be placed in service.
Fillet:	A concave junction formed where two surfaces meet.
Fin:	A narrow linear projection on a formed concrete surface, resulting from mortar flowing into spaces in the formwork; also, a type of blade in a concrete mixer drum.
Final set:	A degree of stiffening of a mixture of cement and water greater than initial set, generally stated as an empirical value indicating the time in hours and minutes required for a cement paste to stiffen sufficiently to resist to an established degree, the penetration of a weighted test needle; also applicable to concrete and mortar mixture with use of suitable test procedures.
Final setting time:	The time required for a freshly mixed cement paste, mortar, or concrete to achieve final set.
Final stress:	In prestressed concrete, the stress which exists after substantially all losses have occurred.
Fineness modulus:	A factor obtained by adding the total percentage of material in the sample that are coarser than each of the following sieve (cumulative percentages retained), and dividing the sum by 100: 150- μm (No.100), 300- μm (No.50), 600- μm (No.30), 1.18mm (No.16), 2.36mm (No.8), 4.75mm (No.4), 9.5mm (3/8-in.), 19.0mm (3/4 in.), 37.5mm (1 1/2 in.), 75mm (3 in.), 150mm (6in.).
Finish grinding:	The final grinding of clinker into cement, with calcium sulfate in the form of gypsum or anhydrite generally being added; the final grinding operation required for a finished concrete surface, e.g. bump cutting of pavement, fin removal from structural concrete, terrazzo floor grinding.
Finishing:	Levelling, smoothing, consolidating, and otherwise treatment surfaces of fresh or recently placed concrete or mortar to produce desired appearance and service.

Finishing machine:	A power-operated machine used to produce the desired surface texture on a concrete slab.
Flash coat:	A light coat of shotcrete used to cover minor blemishes on a concrete surface.
Flat slab:	A concrete slab reinforced in two or more directions and having drop panels or column capitals or both.
Flatwork, concrete:	A general term applicable to concrete floors and slabs that require finishing operations.
Flexible pavement:	A pavement structure which maintains intimate contact with and distributes loads to the subgrade and depends on aggregate interlock, particle friction, and cohesion for stability; cementing agents, where used, are generally bituminous materials as contrasted to hydraulic cement in the case of rigid pavement.
Flexural rigidity:	A measure of stiffness of a member, indicated by the product of modulus of elasticity and moment of inertia divided by the length of the member.
Flexural strength:	The property of a material or a structural member that indicates its ability to resist failure in bending; in concrete flexural members, the bending moment at which a section reaches its maximum usable bending capacity; for under-reinforced concrete flexural members, the bending moment at which the compressive strain in the concrete reaches 0.003; for over-reinforced concrete flexural members, the bending moment at which the compressive stress reaches 85 percent of the cylinder strength of the concrete; for un-reinforced concrete members, the bending moment at which the concrete tensile strength reaches the modulus of rupture
Fly ash:	The finely divided residue resulting from the combustion of ground or powdered coal and which is transported from the firebox through the boiler by flue gases.
Fog curing:	(1) Storage of concrete in a moist room in which the desired high humidity is achieved by the atomization of fresh water. (2) Application of atomized fresh water to concrete, stucco, mortar, or plaster.
Form:	A temporary structure or mold for the support of concrete while it is setting and gaining sufficient strength to be self-supporting.
Form scabbing:	Inadvertent removal of the surface of concrete because of adhesion to the form.
Free fall:	Descent of freshly mixed concrete into forms without Drop chutes or other means of confinement; also, the distance through which such descent occurs; also, uncontrolled fall of aggregate.

Free lime:	Calcium oxide (CaO) as in clinker and cement which has not combined with SiO ₂ , Al ₂ O ₃ , or Fe ₂ O ₃ during the burning process, usually because of under burning, insufficient grinding of the raw mix, or the presence of traces of inhibitors.
Free moisture:	Moisture having essentially the properties of pure water in bulk; moisture not absorbed by aggregate.
Friction loss:	The stress loss in a prestressing tendon resulting from friction between the tendon and duct or other device during stressing.
Friction pile:	A load-bearing pile which receives its principal vertical support from skin friction between the surface of the buried pile and the surrounding soil.
Frog:	A depression in the bed surface of a masonry unit; sometimes called a panel.
Girder:	A large beam, usually horizontal, that serves as a main structural member.
Girt:	Small beam spanning between columns generally used in industrial buildings to support outside walls.
Grade beam:	A reinforced concrete beam, usually at ground level, to form a foundation for the walls of a superstructure.
Gradient:	Rate of change in a variable over a distance, as of temperature or moisture.
Grading:	The distribution of particles of granular material among various sizes; usually expressed in terms of cumulative percentage larger or smaller than each of a series of size (sieve openings) or the percentages between certain ranges of size (sieve openings).
Granolithic finish:	A surface layer of granolithic concrete which may be laid on a base of either fresh or hardened concrete.
Gravel:	(1) Granular material predominantly retained on the 4.75mm (No.4) sieve and resulting either from natural disintegration and abrasion of rock or processing of weakly bound conglomerate (2) That portion of an aggregate retained on the 4.75mm (No.4) sieve and resulting either from natural disintegration and abrasion of rock or processing of weakly bound conglomerate.
Grid foundation:	A combined footing formed by intersecting continuous footings, loaded at the intersection points, and covering much of the total area within the outer limits of the assembly.
Grout:	A mixture of cementitious material and water, with or without aggregate, proportioned to produce a pourable consistency without segregation of the constituents; also a mixture of other composition but of similar consistency.

Gun:	(1) Shotcrete material delivery equipment, usually consisting of double chambers under pressure; equipment with a single pressure chamber is used to some extent. (2) Pressure cylinder used to propel freshly mixed concrete pneumatically.
Hacking:	The roughening of a surface by striking with a tool.
Hairline cracks:	Cracks in an exposed concrete surface having widths so small as to be barely perceptible.
Hanger:	A device used to suspend one object from another object such as the hardware attached to a building frame to support form.
Harsh mixture:	A concrete mixture which lacks desired workability and consistency due to a deficiency of mortar or aggregate fines.
Haunch:	A deepened portion of a beam in the vicinity of a support.
Hunching:	(1) Concrete support to the sides of a drain or sewer. (2) Work done in strengthening or improving the outer strip of a roadway.
Heat of hydration:	Heat evolved by chemical reactions with water, such as that evolved during the setting and hardening of Portland cement, or the difference between the heat of solution of dry cement and that of partially hydrated cement.
High strength steel:	Steel with a high yield point, in the case of reinforcing bars 60,000 psi (414 MPa) and greater.
Hinge joint:	Any joint which permits rotation with no appreciable moment developed in the members at the joint.
Honeycomb:	Voids left in concrete due to failure of the mortar to effectively fill the spaces among coarse aggregate particles.
Hooked bar:	A reinforcing bar with the end bent into a hook to provide anchorage.
Hoop reinforcement:	A one-piece closed tie or continuously wound tie not less than No.3 in size, the ends of which have a standard 135-deg bend with a ten-bar diameter extension, that encloses the longitudinal reinforcement.
Hydration:	Formation of a compound by the combining of water with some other substance; in concrete, the chemical reaction between hydraulic cement and water.
Hydraulic hydrated lime:	The hydrated dry cementitious product obtained by calcining a limestone containing silica and alumina to a temperature short of incipient fusion so as to form sufficient free calcium oxide to permit hydration and at the same time leaving un-hydrated sufficient calcium silicates to give the dry powder its hydraulic properties.

Incrustation:	A crust or coating, generally hard, formed on the surface of concrete masonry construction or on aggregate particles.
Initial drying shrinkage:	The difference between the length of a specimen (molded and cured under state conditions) and its length when first dried to constant length, expressed as a percentage of the moist length.
Initial pre stress:	The pre stressing stress (or force) applied to the concrete at the time of stressing.
Initial set:	A degree of stiffening of a mixture of cement and water less than final set, generally stated as an empirical value indicating the time in hours and minutes required for cement paste to stiffen sufficiently to resist to an established degree, the penetration of a weighted test needle; also applicable to concrete or mortar with use of suitable test procedure.
Initial setting time:	The time required for a freshly mixed cement paste, mortar, or concrete to achieve initial set.
Initial stresses:	The stresses occurring in prestressed concrete members before any losses occur.
I-section:	Beam cross section consisting of top and bottom flanges connected by a vertical web.
Isolation joint:	A separation between adjoining parts of a concrete structure, usually a vertical plane, at a designed location such as to interfere least with performance of the structure, yet such as to allow relative movement in three directions and avoid formation of cracks elsewhere in the concrete and through which all or part of the bonded reinforcement is interrupted.
Jack:	A mechanical device used for applying force to prestressing tendons, for adjusting elevation of forms or form supports, and for raising objects small distances.
Jacking device:	The device used to stress the tendons for prestressed concrete; also, the device for raising a vertical slipform.
Jacking force:	In prestressed concrete, the temporary force exerted by the device which introduces tension into the tendons.
Jacking stress:	The maximum stress occurring in a prestress tendon during stressing.
Jaw crusher:	A machine having two inclined jaws, one or both being actuated by a reciprocating motion so that the charge is repeatedly "nipped" between the jaws.
Joint:	A physical separation in concrete, whether precast or cast-in-place, including cracks if intentionally made to occur at specified locations; also, the region where structural members intersect, such as a beam-column joint.

Joint filler:	Compressible material used to fill a joint to prevent the infiltration of debris and to provide support for sealants.
Joint sealant:	Compressible material used to exclude water and solid foreign materials from joints.
Joist:	A comparatively narrow beam, used in closely spaced arrangements to support floor or roof slab (which require no reinforcement except that required for temperature and shrinkage stresses); also, a horizontal structural member such as that which supports deck form sheathing.
Keyway:	A recess or groove in one lift or placement of concrete which is filled with concrete of the next lift, giving shear strength to the joint.
Knee brace:	Brace between horizontal and vertical members in a building frame or formwork to make the structure more stable; in formwork it acts as a haunch.
Lacing:	Horizontal bracing between shoring members.
Lagging:	Heavy sheathing used as in underground work to withstand earth pressure. Punjab Communication and Works Department Standard Specifications for Building Construction Draft 2016 Page 308 of 69.
Laitance:	A layer of weak and nondurable material containing cement and fines from aggregate, brought by bleeding water to the top of over wet concrete; the amount is generally increased by overworking or overmanipulating concrete at the surface by improper finishing or by job traffic.
Lap:	The length by which one bar reinforcement overlaps another.
Lap splice:	A connection of reinforcing steel made by lapping the ends of the bars.
Lapping (reinforcing steel):	The overlapping of reinforcing steel bars, welded wire fabric, or expanded metal so that there may be continuity of stress in the reinforcing when the concrete member is subjected to loading.
Lateral reinforcement:	Usually applied to ties, hoops, and spirals in columns or column-like members.
Latex:	A water emulsion of a high molecular-weight polymer used especially in coatings, adhesives, leveling compounds, and patching compounds.
Lever arm:	In a structural member, the distance from the center of the tensile reinforcement to the center of action of the compression zone; also, the perpendicular distance of a transverse force from a point about which moment is taken.

Lift:	The concrete placed between two consecutive horizontal construction joints, usually consisting of several layers or courses.
Limit design:	A method of proportioning reinforced concrete members based on calculations of their strength.
Linear prestressing:	Prestressing applied to linear members such as beams, columns etc.
Lining:	Any sheet, plate, or layer of material attached directly to the inside face of formwork to improve or alter the surface texture and quality of the finished concrete.
Lintel:	A horizontal supporting member above an opening such as a window or a door.
Load factor:	A factor by which a service load is multiplied to determine a factored load used in the strength design.
Load-bearing wall:	A wall designed and built to carry super-imposed vertical and shear loads.
Load-transfer assembly:	The unit (basket or plate) designed to support or link dowel bars during concrete operations so as to hold them in place while in the desired alignment.
Loading hopper:	A hopper in which concrete or other free flowing material is deposited for discharge into buggies or other conveyances used for delivery to the forms or to other. Punjab Communication and Works Department Standard Specifications for Building Construction Draft 2016 Page 309 of 691 place or processing, use, or storage.
Locking device:	A device used to secure a cross brace in scaffolding to the frame or panel.
Longitudinal cracks:	Cracks that develop parallel to the length of a member.
Longitudinal joint:	A joint parallel to the length of a structure or pavement.
Longitudinal reinforcement:	Reinforcement parallel to the length of a concrete member or pavement
Loss Angeles Abrasion Test:	Test for abrasion resistance of concrete aggregates.
Loss of pre stress:	The reduction in pre stressing force which results from the combined effects of slip at anchorage, relaxation of steel stress, frictional loss due to curvature in the tendons, and the effects of elastic shortening, creep and shrinkage of the concrete.
Macadam, cement-bound:	A road consisting of broken stone, crushed slag, or gravel and either a grout or mortar filler; formed by rolling a base of stone, slag, or gravel to a compacted mass having an even surface, and then rolling in the cementitious filler.

Map cracking:	<p>(1) Intersecting cracks that extend below the surface of hardened concrete; caused by shrinkage of the drying surface concrete which is restrained by concrete at greater depths where either little or no shrinkage occurs; vary in width from fine and barely visible to open and well-defined.</p> <p>(2) The chief symptom of chemical reaction between alkalis in cement and mineral constituents in aggregate within hardened concrete; due to differential rate of volume change in different portions of the concrete; cracking is usually random and on a fairly large scale, and in severe instances the cracks may reach a width of 0.50 inch (12.7mm).</p>
Mat foundation:	A continuous footing supporting an array of columns in several rows in each direction, having a slab-like shape with or without depressions or openings, covering an area at least 75% of the total area within the outer limits of the assembly.
Matrix:	In the case of mortar, the cement paste in which the fine aggregate particles are embedded; in the case of concrete, the mortar in which the coarse aggregate particles are embedded.
Mechanical bond:	<p>(1) In general concrete construction, the physical interlock between cement paste and aggregate, or between concrete and reinforcement (specifically, the sliding resistance of an embedded bar and not the adhesive resistance).</p> <p>(2) In plastering, the physical keying of a plaster coat to: (a) another, (b) to the plaster base by means of plaster keys to the lath, or (c) through interlock with adjacent plaster casts created by means of scratching or cross raking.</p>
Membrane curing:	A process that involve either liquid sealing compound (e.g. bituminous and paraffinic emulsions, coal tar cutbacks, pigmented and non-pigmented resin suspensions, or suspensions of wax and drying oil) or non-liquid protective coating (e.g. sheet plastics or “waterproof” paper), both of which types function as films to restrict evaporation of mixing water from the fresh concrete surface.
Mesh:	The number of openings (including fractions thereof) per unit of length in either a screen or sieve in which the openings are $\frac{1}{4}$ inch (6mm) or less.
Micro cracks:	Microscopic cracks within concrete.
Micron:	An obsolete term designating a unit of length equal to one thousandth of a millimeter or one millionth of a meter; superseded by micrometer (μm).
Middle strip:	In flat-slab framing, the slab portion which occupies the middle half of the span between columns.
Mixer, efficiency:	The adequacy of a mixer in rendering a homogeneous product within a stated period; homogeneity is determinable by testing for relative differences in physical properties or composition of

samples extracted from different portions of a freshly mixed batch.

- Mixing cycle:** The time taken for a complete cycle in a batch mixer, i.e. the time elapsing between successive repetitions of the same operation (e.g. successive discharges of the mixer).
- Modified cube:** A portion of a rectangular beam of hardened concrete previously broken in flexure; used in determining the compressive strength of the concrete.
- Modified Portland Cement:** A Portland cement having moderate heat of hydration.
- Modular ratio:** The ratio of modulus of elasticity of steel E_s , to that of concrete E_c ; usually denoted by the symbol n .
- Modulus of compression:** The ratio of compressive stress to cubical compression; always positive for all physical substances; also known as bulk modulus; related to Young's modulus and Poisson's ratio by the equation
 $K = E \div 3 (1 - 2\mu)$, where k = bulk modulus, E = Young's modulus, and μ = Poisson's ratio of the material under consideration.
- Modulus of deformation:** (1) A concept of modulus of elasticity expressed as a function of two-time variables; strain in loaded concrete as a function of the age at which the load is initially applied and of the length of time the load is sustained.
(2) The ratio of stress to strain for a material that does not deform in accordance with Hooke's law when subjected to applied load.
- Modulus of elasticity:** The ratio of normal stress to corresponding strain for tensile or compressive stress below the proportional limit of the material; also referred to as elastic modulus, Young's modulus, and Young's modulus of elasticity; denoted by the symbol E .
- Modulus of rigidity:** The ratio of unit shearing stress to the corresponding unit shearing strain; referred to as shear modulus and modulus of elasticity in shear.
- Modulus of rupture:** A measure of the ultimate load-carrying capacity of a beam and sometimes referred to as rupture modulus or rupture strength. It is calculated for apparent tensile stress in the extreme fiber of a transverse test specimen under the load which produces rupture. Note: the actual stress in the extreme fiber is less than the apparent stress since the flexure formula employed in the calculation is valid only for stress within the proportional limit of the material; nevertheless, the nominal rupture strength so obtained is considered the rupture modulus.
- Mohs scale:** Arbitrary quantitative units, ranging from 1 through 10, by means of which the scratch hardness of a mineral is determined; each unit of hardness is represented by a mineral that can scratch any other mineral having a lower-ranking number; the minerals are ranked from talc or 1 (the softest), upward through gypsum

or 2, calcite or 3, fluorite or 4, apatite or 5, orthoclase or 6, quartz or 7, topaz or 8, corundum or 9, and diamond or 10 (the hardest).

Moist:	Slightly damp but not quite dry to the touch; the terms “wet” implies visible free water “damp” implies less wetness than wet and moist implies not quite dry.
Moist-air curing:	Curing in moist air (not less than 95 percent relative humidity) at atmospheric pressure and normally at a temperature approximating 73F (22.8C) temperature and at least 95 percent relative humidity.
Moist room:	A room in which the atmosphere is maintained at a selected temperature (usually 23.0+1.7C or 73.4+3.0F) and a relative humidity of at least 95 percent, for the purpose of curing and storing cementitious test specimens; the facilities must be sufficient to maintain free moisture continuously on the exterior of test specimens; also known as a fog room.
Moisture content of aggregate:	The ratio, expressed as a percentage, of the mass of water in a given granular mass to the dry weight of the mass.
Mold:	(1) a device containing a cavity into which neat cement, mortar, or concrete test specimens are cast. (2) A form used in the fabrication of precast mortar or concrete units (e.g. masonry units).
Moment distribution:	A method of structural analysis for continuous beams and rigid frames whereby successive converging corrections are made to an assumed set of moments until the desired precision is obtained.
Monolith:	A body of plain or reinforced concrete cast or erected as a single integral mass or structure.
Monolithic topping:	On flatwork: a higher quality, more serviceable topping course placed promptly after the base course has lost all slump and bleed water.
Moving forms:	Large prefabricated units of formwork incorporating supports, and designed to be moved horizontally on rollers or similar devices, with a minimum amount of dismantling between successive uses.
Multistage stressing:	Pre-stressing performed in stages as the construction progresses.
Mushroom system of flat-slab construction:	A four-way reinforced concrete girder-less floor slab in which the column reinforcing bars are bent down into the slab around the column head in radial directions and additional reinforcing bars bent into rings laid upon the radials, thus forming a spider web to provide additional reinforcement at the column head and to support the slab steel; mushroom designs of the true flat-slab

	type do not involve drop panels around the capitals of the columns.
Natural pozzolan:	Either a raw or calcined natural material that has pozzolanic properties (e.g. volcanic ash or pumicite, opaline chert and shales, tuffs, and some diatomaceous earths).
Neat cement grout:	A fluid mixture of hydraulic cement and water, with or without admixture; also, the hardened equivalent of such mixture.
Negative moment:	A condition of flexure in which top fibers of a horizontally placed member, or external fibers of a vertically placed exterior member, are subjected to tensile stresses.
Negative reinforcement:	Steel reinforcement for negative moment.
Neutral axis:	A line in the plane of a structural member subject to bending where the longitudinal stress is zero.
Nominal mixture:	The proportions of the constituents of a proposed concrete mixture.
Nominal strength:	Strength of a member or cross section calculated in accordance with provisions and assumptions of the strength design method before application of any strength reduction factor.
Non-bearing wall:	A wall that supports no vertical load other than its own weight.
Non-pre-stressed reinforcement:	Reinforcing steel, not subjected to either pre-tensioning or post-tensioning.
Normal consistency:	(1) the degree of wetness exhibited by a freshly mixed concrete, mortar, or neat cement grout when the workability of the mixture is considered acceptable for the purpose at hand. (2) The physical condition of neat cement pastes as determined with the Vicat apparatus in accordance with a standard method of test.
Normal stress:	The stress component that is perpendicular to the plane on which the force is applied; designated tensile if the force is directed away from the plane and compressive if the force is directed toward the plane.
Offset:	An abrupt change in alignment or dimension, either horizontally or vertically; a horizontal ledge occurring along a change in wall thickness of the wall above.
Offset bend:	An intentional distortion from the normal straightness of a steel reinforcing bar in order to move the center line of a segment of the bar to a position parallel to the original position of the center line; a mechanical operation commonly applied to vertical bars that reinforce concrete columns.

Oven-dry:	The condition resulting from having been dried to essentially constant mass, in an oven, at a temperature that has been fixed, usually between 221 and 239°F (105 and 115°C).
Overdesign:	To require adherence to structural design requirements higher than service demands, as a means of compensating for statistical variation or for anticipated deficiencies or both.
Over-sanded:	Containing more sand than would be necessary to produce adequate workability and a satisfactory condition for finishing.
Overstretching:	Stressing of tendons to a value higher than designed for the initial stress to: (a) overcome frictional losses, (b) temporarily overstress the steel to reduce steel creep that occurs after anchorage, and (c) counteract loss of pre-stressing force that is caused by subsequent pre-stressing of other tendons.
Over-vibration:	Excessive use of vibrators during placement of freshly mixed concrete, causing segregation, stratification, and excessive bleeding.
Panel:	(1) A section of form sheathing, constructed from boards, plywood, metal sheets, etc., that can be erected and stripped as a unit. (2) A concrete member, usually precast, rectangular in shape, and relatively thin with respect to other dimensions.
Panel strip:	A strip extending across the length or width of a flat slab for structural design and construction or for architectural purposes.
Partial pre-stressing:	Pre-stressing to a stress level such that, under design load, tensile stresses exist in the pre-compressed tensile zone of the pre-stressed member.
Partial release:	Release into a pre-stressed concrete member of a portion of the total pre-stress initially held wholly in the pre-stressed reinforcement.
Pavement (concrete):	A layer of concrete over such areas as roads, sidewalks, canals, playgrounds, and those used for storage or parking.
Pedestal:	An upright compression member whose height does not exceed three times its average least dimension, such as a short pier or plinth used as the base for a column.
Percentage of reinforcement:	The ratio of cross-sectional area of reinforcing steel to the effective cross-sectional area of a member, expressed as a percentage.
Permanent form:	Any form that remains in place after the concrete has developed its design strength; it may or may not become an integral part of the structure.

Permeability to water, coefficient of:	The rate of discharge of water under laminar flow condition through a unit cross-sectional area of a porous medium under a unit hydraulic gradient and standard temperature condition, usually 20C.
Phi (Ø) factor:	Capacity reduction factor (in structural design); a number less than 1.0 (usually 0.65-0.90) by which the strength of a structural member or element (in terms of load, moment, shear, or stress) is required to be multiplied in order to determine design strength or capacity; the magnitude of the factor is stipulated in applicable codes and construction specifications for respective types of members and cross sections.
Pigment:	A coloring matter, usually in the form of an insoluble fine powder.
Pile:	A slender timber, concrete, or steel structural element, driven, jettted, or otherwise embedded on end in the ground for the purpose of supporting a load or of compacting the soil.
Pile bent:	Two or more piles driven in a row transverse to the long dimension of the structure and fastened together by capping and (sometimes) bracing.
Pile cap:	(1) A structural member that is placed on top of a group of piles and used to transmit loads from the structure through the pile group into the soil; the piles may be connected to the cap with reinforcement to resist uplift or with reinforcement to resist moment so as to form a bent; also known as a rider cap or girder; also, a masonry, timber, or concrete footing resting on a group of piles. (2) A metal cap or helmet temporarily fitted over the head of a precast pile to protect it during driving; some form of shock-absorbing material is often incorporated.
Pipe column:	Column made of steel pipe; often filled with concrete.
Pipe pile:	A steel cylinder, usually between 10 and 24 inches (250 and 600mm) in diameter, generally driven with open ends to firm bearing and then excavated and filled with concrete, this pile may consist of several sections from 5 to 40 feet (1.5 to 8m) long joined by special fitting such as cast steel sleeves and is sometimes used with its lower end closed by a conical steel shoe.
Pitting:	Development of relatively small cavities in a surface; in concrete, localized disintegration, such as a pop-out; in steel, localized corrosion evident as minute cavities on the surface.
Placement:	The process of placing and consolidating concrete; a quantity of concrete placed and finished during a continuous operation; in appropriately referred to as pouring.

Placing:	The deposition, distribution, and consolidation of freshly mixed concrete in the place where it is to harden; inappropriately referred to as pouring.
Plain bar:	A reinforcing bar without surface deformations, or one having deformations that do not conform to the applicable requirements.
Plane of weakness:	The plane along which a body under stress will tend to fracture; may exist by design, by accident, or because of the nature of the structure and its loading.
Plaster:	A cementitious material or combination of cementitious material and fine aggregate that, when mixed with a suitable amount of water, forms a plastic mass or paste which when applied to surface, and harden to it and subsequently hardens, preserving in a rigid state the form or texture imposed during the period of plasticity; also, the placed and hardened mixture.
Plastic consistency:	Condition of freshly mixed cement paste, mortar, or concrete such that deformation will be sustained continuously in any direction without rupture.
Plastic cracking:	Cracking that occurs in the surface of fresh concrete soon after it is placed and while it is still plastic.
Plastic hinge:	Region where ultimate moment capacity in a member may be developed and maintained with corresponding significant inelastic rotation as main tensile steel elongates beyond yield strain.
Plastic limit:	The water content at which a soil will just begin to crumble when rolled into a thread approximately 1/8 inch (3mm) in diameter.
Plasticity:	A complex property of a material involving a combination of qualities of mobility and magnitude of yield value; the property of freshly mixed cement paste, concrete, or mortar that determines its resistance to deformation or ease of molding.
Plasticity index:	The range in water content through which a soil remains plastic; numerical difference between the liquid limit and the plastic limit.
Plasticize:	To produce plasticity or to render plastic. Plasticizer A material that increases the plasticity of a fresh cement paste, mortar, or concrete.
Plate:	(1) In formwork for concrete: a flat, horizontal member either at the top or bottom, or both, of studs or posts; a mud sill if on the ground. (2) In structural design: a member, the depth of which is substantially less than its length and width.
Plum:	A large random-shaped stone dropped into freshly placed mass concrete to economize on the volume of the concrete.

Point load:	A load whose area of contact with the resisting body is negligible in comparison with the area of the resisting body.
Point of inflection:	The point on the length of a structural member subjected to flexure where the curvature changes from concave to convex or conversely and at which the bending moment is zero; also called "point of contra-flexure", location of an abrupt bend in a plotted locus of points in a graph.
Poisson's ratio:	The ratio of transverse (lateral) strain to the corresponding axial (longitudinal) strain resulting from uniformly distributed axial stress below the proportional limit of the material; the value will average about 0.2 for concrete and 0.25 for most metals.
Polish or final grind:	The final operation in which fine abrasives are used to hone a surface to its desired smoothness and appearance.
Polyester:	One of a large group of synthetic resins, mainly produced by reaction of dibasic acids with dihydroxy alcohols; commonly prepared for application by mixing with a vinyl-group monomer and free-radical catalysts at ambient temperatures and used as binders for resin mortars and concrete, fiber laminates (mainly glass), adhesives, and the like.
Polyethylene:	A thermoplastic high-molecular-weight organic compound used in formulating protective coatings or, in sheet form, as a protective cover for concrete surface during the curing period, or to provide a temporary enclosure for construction operations.
Polymer:	The product of polymerization; more commonly a rubber or resin consisting of large molecules formed by polymerization.
Polymerization:	The reaction in which two or more molecules of the same substance combine to form a compound containing the same elements, and in the same proportions, but of higher molecular weight, from which the original substance can be generated, in some cases only with extreme difficulty.
Polystyrene resin:	Synthetic resin, varying from colorless to yellow, formed by the polymerization of styrene on heating with or without catalysts, that may be used in paints for concrete, or for making sculptured molds, or as insulation.
Polysulfide coating:	A protective coating system prepared by polymerizing a chlorinated alkyl polyether with an inorganic polysulfide.
Polyurethane:	Reaction product of an isocyanate with any of a wide variety of other compounds containing an active hydrogen group; used to formulate tough, abrasion-resistant coatings.
Polyvinyl acetate:	Colorless, permanently thermoplastic resin; usually supplied as an emulsion or water-dispersible powder characterized by flexibility, stability towards light, transparency to ultraviolet rays, high dielectric strength, toughness, and hardness; the higher the

degree of polymerization, the higher the softening temperature; may be used in paints for concrete.

- Polyvinyl chloride:** A synthetic resin prepared by the polymerization of vinyl chloride, used in the manufacture of non-metallic water stops for concrete.
- Pop-out:** The breaking away of small portions of a concrete surface due to localized internal pressure which leaves a shallow, typically conical, depression; small pop-outs leave holes up to 10mm in diameter, medium pop-outs leave holes 10 to 50mm in diameter, large pop-outs leave holes greater than 50mm in diameter.
- Porosity:** The ratio, usually expressed as a percentage of the volume of voids in a material to the total volume of the material including the voids.
- Positive displacement:** Wet-mix shotcrete delivery equipment in which the material is pushed through the material hose in a solid mass by a piston or auger.
- Positive moment:** A condition of flexure in which, for a horizontal simply supported member, the deflected shape is normally considered to be concave downward and the top fibers subjected to compression stresses; for other members and other conditions consider positive and negative as relative terms. Note: for structural design and analysis, moments may be designated as positive or negative with satisfactory results as long as the sign convention adopted is used consistently.
- Post-tensioning:** A method of pre-stressing reinforced concrete in which tendons are tensioned after the concrete has hardened.
- Precast:** A concrete member that is cast and cured in other than its final position; the process of placing and finishing precast concrete.
- Precast pile:** A reinforced pile manufactured in a casting plant or at the site but not in its final position.
- Tensioning:** Some of the tendons are pre-tensioned and a portion of the tendons are post-tensioned.
- Preservation:** The process of maintaining a structure in its present condition and arresting further deterioration.
- Pressure line:** Locus of force points within a structure resulting from combined pre-stressing force and externally applied load.
- Pre-stress:** To place a hardened concrete member or an assembly of units in a state of compression prior to application of service loads; the stress developed by pre-stressing, such as by pre-tensioning or post-tensioning.

Pre-stressing steel:	High-strength steel used to pre-stress concrete, commonly seven-wire strands, single wires, bars, rods, or groups of wires or strands.
Pre-tensioning:	A method of pre-stressing reinforced concrete in which the tendons are tensioned before the concrete has hardened.
Pre-tensioning bed:	The casting bed on which pre-tensioned members are manufactured and which resists the pre-tensioning force prior to release.
Principal stress:	Maximum and minimum stresses at any point acting at right angles to the mutually perpendicular planes of zero shearing stress, which are designated as the principal plans.
Proof stress:	Stress applied to materials sufficient to produce a specified permanent strain; a specific stress to which some types of tendons are subjected in the manufacturing process as a mean of reducing the deformation of anchorage, reducing the relaxation of steel, or insuring that the tendon is sufficiently strong.
Proportioning:	Selection of proportions of ingredients to make the most economical use of available materials to produce mortar or concrete of the required properties.
Pumice:	A highly porous and vesicular lava usually of relatively high silica content composed largely of glass drawn into approximately parallel or loosely entwined fibers, which themselves contain sealed vesicles.
Pumping (of pavements):	The ejection of water, or water and solid materials such as clay or silt along transverse or longitudinal joints and cracks, and along pavement edges caused by downward slab movement activated by the passage of loads over the pavement after the accumulation of sage of loads over the pavement after the accumulation of free water on or in the base course, subgrade, or subbase.
Punching shear:	(1) Shear stress calculated by dividing the load on a column by the product of its perimeter and the thickness of the base or cap or by the product of the perimeter taken at one half the slab thickness away from the column and the thickness of the base or cap. (2) Failure of a base when a heavily loaded column punches a hole through it.
Purlin:	In roofs, a horizontal member supporting the common rafters.
Putty:	A plaster composed of quick lime or hydrated lime and water with or without plaster of Paris or sand.
Raft foundation:	A continuous slab of concrete, usually reinforced, laid over soft ground or where heavy loads must be supported to form a foundation.

Rail-steel reinforcement:	Reinforcing bars hot-rolled from standard T-section rails.
Ramming:	A form of heavy tamping of concrete, grout, or the like by means of a blunt tool forcibly applied.
Raw mix:	Blend of raw materials, ground to desired fineness, correctly proportioned, and blended ready for burning; such as that used in the manufacture of cement clinker.
Reactive silica material:	Several types of materials which react at high temperatures with Portland cement or lime during autoclaving; includes pulverized silica, natural pozzolan, and fly ash.
Rebound:	Aggregate and cement, or wet shotcrete, that bounces away from the surface against which shotcrete is being projected.
Reinforcement:	Bars, wires, strands, or other slender members which are embedded in concrete in such a manner that they and the concrete act together in resisting forces.
Reinforcement ratio:	Ratio of the effective area of the reinforcement to the effective area of the concrete at any section of a structural member.
Relative humidity:	The ratio of the quantity of water vapor actually present to the amount present in a saturated atmosphere at a given temperature; expressed as a percentage.
Release agent:	Material used to prevent bonding of concrete to a surface.
Reproducibility:	Variability among replicate test results obtained on the same material in different laboratories; a quantity that will be exceeded in only about 5 percent of the repetitions by the difference, taken in absolute value, of two single test results made on the same material in two different, randomly selected laboratories; in use of the term all variable factors should be specified.
Required strength:	Strength of a member or cross section required to resist factored loads or related internal moments and forces in such combinations as are stipulated in the applicable code or specification.
Resin:	A natural or synthetic, solid or semisolid, organic material of indefinite and often high molecular weight having a tendency to flow under stress, usually has a softening or melting range, and usually fractures conchoidally.
Restraint (of concrete):	Restriction of free movement of fresh or hardened concrete following completion of placing in formwork or molds or within an otherwise confined space; restraint can be internal or external and may act in one or more directions.
Retardation:	Reduction in the rate of either hardening or setting or both, i.e. an increase in the time required to reach time of initial and final

	setting or to develop early strength of fresh concrete, mortar, or grout.
Retarder:	An admixture that delays the setting of cement paste, and hence of mixtures such as mortar or concrete containing cement.
Reveal:	The vertical surface forming the side of an opening in a wall, as for a window or door; depth of exposure of aggregate in an exposed aggregate finish.
Rib:	One of a number of parallel structural members backing sheathing; the portion of a T-beam which projects below the slab; in deformed reinforcing bars, the deformations or the longitudinal parting ridge.
Ribbed panel:	A panel composed of a thin slab reinforced by a system of ribs in one or two directions, usually orthogonal.
Rigid frame:	A frame depending on moment in joints for stability.
Rigid pavement:	Pavement that will provide high bending resistance and distribute loads to the foundation over a comparatively large area.
Roof insulation:	Low-density concrete used for insulating purposes only and placed over a structural roof system.
Rough grind:	The initial operation in which coarse abrasives are used to cut the projecting stone chips in hardened terrazzo down to a level surface.
Rubbed finish:	A finish obtained by using an abrasive to remove surface irregularities from concrete.
Rubble:	Rough stones of irregular shape and size, broken from larger masses by geological processes or by quarrying; concrete reduced to irregular fragments, as by demolition or natural catastrophe.
Sack rub:	A finish for formed concrete surfaces, designed to produce even texture and fill all pits and air holes after dampening the surface, mortar is rubbed over the surface; then, before the surface dries, a mixture of dry cement and sand is rubbed over it with either a wad of burlap or a sponge-rubber float to remove surplus mortar and fill voids.
Sandblast:	A system of cutting or abrading a surface such as concrete by a stream of sand ejected from a nozzle at high speed by compressed air; often used for cleanup of horizontal construction joints or for exposure of aggregate in architectural concrete.
Sand box (or sand jack):	A tight box filled with clean, dry, sand on which rests a tight-fitting timber plunger that supports the bottom of posts used in centering; removal of a plug from a hole near the bottom of the

	box permits the sand to run out when it is necessary to lower the centering.
Sand-coarse aggregate ratio:	Ratio of fine to coarse aggregate in a batch of concrete, by mass or by volume.
Sand equivalent:	A measure of the relative proportions of detrimental fine dust or claylike material or both in soils or fine aggregate.
Sand stone:	A cemented or otherwise compacted sedimentary rock composed predominantly of sand grains.
Saturation:	In general: the condition of coexistence in stable equilibrium of either a vapor and a liquid or a vapor and solid phase of the same substance at the same temperature; (2) as applied to aggregate or concrete: the condition such that no more liquid can be held or placed within it.
Scaffolding:	A temporary structure for the support of deck forms, cart ways, or workers, or a combination of these such as an elevated platform for supporting workers, tools, and materials; adjustable metal scaffolding is frequently adapted for shoring in concrete work.
Scale:	The oxide formed on the surface of the metal during heating.
Scour:	Erosion of a concrete surface, exposing the aggregate.
Screed:	(1) To strike off concrete lying above the desired plane or shape. (2) a tool for striking off the concrete surface, sometimes referred to as a strike-off.
Screen:	Production equipment for separating granular material according to size, using woven-wire cloth or other similar device with regularly spaced apertures of uniform size.
Sealing compound:	A liquid that is applied as a coating to the surface of hardened concrete to either prevent or decrease the penetration of liquid or gaseous media, e.g., water, aggressive solutions, and carbon dioxide, during service exposure.
Secondary moment:	In statically indeterminate structures, the additional moments caused by deformation of structure due to the applied forces; in statically indeterminate prestressed concrete structures, the additional moments caused by the use of a non-concordant prestressing tendon.
Section modulus:	A term pertaining to the cross section of a flexural member; the section modulus with respect to either principal axis is the moment of inertia with respect to that axis divided by the distance from that axis to the most remote point of the tension or compression area of the section, as required; the section modulus is used to determine the flexural stress in a beam.

Segmental member:	A structural member made up of individual elements pre-stressed together to act as a monolithic unit under service loads.
Segregation:	The differential concentration of the components of mixed concrete, aggregate, or the like resulting in non-uniform proportions in the mass.
Separation:	The tendency, as concrete is caused to pass from the unconfined ends of chutes or conveyor belts or similar arrangements, for coarse aggregate to separate from the concrete and accumulate at one side; the tendency, as processed aggregate leaves the ends of conveyor belts, chutes, or similar devices with confining sides, for the larger aggregate to separate from the mass and accumulate at one side; or the tendency for the solids to separate from the water by gravitational settlement.
Service dead load:	The dead weight supported by a member.
Service live load:	The live load specified by the general building code or bridge specification, or the actual nonpermanent load applied in service.
Set:	The condition reached by a cement paste, mortar, or concrete when it has lost plasticity to an arbitrary degree, usually measured in terms of resistance to penetration or deformation; initial set refers to first stiffening; final set refers to attainment of significant rigidity; also, strain remaining after removal of stress.
Settlement:	Sinking of solid particles in grout, mortar, or fresh concrete, after placement and before initial set.
Setting:	The lowering in elevation of sections of pavement or structures due to their mass, the loads imposed on them, or shrinkage or displacement of the support.
Sharp sand:	Coarse sand consisting of particles of angular shape.
Shear:	An internal force tangential to the plane on which it acts.
Shear-head:	Assembled unit in the tip of the columns of flat slab or flat plate construction to transmit load from slab to column.
Shear reinforcement:	Reinforcement designed to resist shear or diagonal tension stresses.
Shear strength:	The maximum shearing force a flexural member can support at a specific location as controlled by the combined effects of shear force and bending moment.
Shear stress:	The stress component acting tangentially to a plane.
Shear wall:	A wall portion of a structural frame intended to resist lateral forces, such as earthquake, wind, and blast, acting in the plane of the wall.

Sheath:	An enclosure in which post-tensioning tendons are encased to prevent bonding during concrete placement.
Sheathing:	The material forming the contact face of forms; also called lagging or sheeting.
Sheet pile:	A pile in the form of a plank driven in close contact or interlocking with other to provide a tight wall to resist the lateral pressure of water, adjacent earth, or other materials; may be tongued and grooved if made of timber or concrete and interlocking if made of metal.
Shell construction:	Construction using thin curved slabs.
Shock load:	Impact of material such as aggregate or concrete as it is released or dumped during placement.
Shooting:	Placing of shotcrete.
Shore:	A temporary support for form work and fresh concrete or for recently built structures which have not developed full design strength; also called prop, tom, post, strut.
Shoring:	Props or posts of timber or other material in compression used for the temporary supports of excavations, formwork or unsafe structures; the process of erecting shores.
Shoring, horizontal:	Metal or wood load-carrying strut, beam, or trussed section use to carry a shoring load from one bearing point, column, frame, post, or wall to another; may be adjustable.
Shotcrete:	Mortar or concrete pneumatically projected at high velocity onto a surface; also known as air-blown mortar, pneumatically applied mortar or concrete, sprayed mortar, and gunned concrete.
Shoulder:	An unintentional offset in a formed concrete surface usually caused by bulging or movement of formwork.
Shrinkage:	Decrease in either length or volume. Note: may be restricted to effects of moisture content or chemical changes.
Shrinkage, carbonation:	Shrinkage resulting from carbonation.
Shrinkage, plastic:	Shrinkage that takes place before cement paste, mortar, grout, or concrete sets.
Shrinkage crack:	Crack due to restraint of shrinkage.
Shrinkage cracking:	Cracking of a structure or member due to failure in tension caused by external or internal restraints as reduction in moisture content develops, or as carbonation occurs, or both.

Shrinkage limit:	The maximum water content at which a reduction in water content will not cause a decrease in volume of the soil masses.
Shrinkage loss:	Reduction of stress in pre-stressing steel resulting from shrinkage of concrete.
Shrinkage reinforcement:	Reinforcement designed to resist shrinkage stresses in concrete.
Si (System International):	The modern metric system;
Sieve analysis:	Particle size distribution; usually expressed as the weight percentage retained upon each of a series of standard sieves of decreasing size and the percentage passed by the sieve of finest size.
Sieve correction:	Correction of a sieve analysis to adjust for deviation of sieve performance from that of standard calibrated sieves.
Sieve fraction:	That portion of a sample which passed through standard sieve of specified size and is retained by some finer sieve of specified size.
Sieve number:	A number used to designate the size of a sieve, usually the approximate number of openings per linear inch; applied to sieve with openings smaller than 6.3 mm (1/4 in.)
Simple beam:	A beam without restraint or continuity at its supports; also known as a simply supported beam.
Skid resistance:	A measure of the frictional characteristics of a surface.
Slab-jacking:	The process of either raising concrete pavement slabs or filling voids under them, or both, by injecting material (cementitious, non-cementitious, or as phalitic) under pressure.
Slender beam:	A beam, which, if loaded to failure without lateral bracing of the compression flange, would fail by buckling rather than in flexure.
Slenderness ratio:	The effective unsupported length of a uniform column divided by the least radius of gyration of the cross-sectional area.
Slip:	Movement occurring between steel reinforcement and concrete in stressed reinforced concrete, indicating a chorage breakdown.
Slip form:	A form that is pulled or raised as concrete is placed; may move in a generally horizontal direction to lay concrete evenly for highway paving or on slopes and inverts of canals, tunnels, and siphons; or may move vertically to form walls, bins, or silos.
Sloped footing:	A footing having sloping top or side faces.

Sloughing:	Subsidence of shotcrete, plaster, or the like, due generally to excessive water in the mixture; also called sagging.
Slugging:	Pulsating and intermittent flow of shotcrete material due to improper use of delivery equipment and materials.
Slump:	A measure of consistency of freshly mixed concrete, mortar, or stucco equal to the subsidence measured to the nearest $\frac{1}{4}$ in. (6mm) of the molded specimen immediately after removal of the slump cone.
Slump cone:	A mold in the form of the lateral surface of the frustum of a cone with base diameter of 8 in. (203 mm), top diameter 4 in. (102 mm), and height 12 in. (305 mm), used to fabricate a specimen of freshly mixed concrete for the slump test; a cone 6 in. (152 mm), high is used for tests of freshly mixed mortar and stucco.
Slump loss:	The amount by which the slump of freshly mixed concrete changes during a period of time after an initial slump test was made on a sample or samples thereof.
Slurry:	A mixture of water and any finely divided insoluble material, such as Portland cement, slag, or clay in suspension.
Soffit:	The underside of a part or member of a structure, such as a beam, stairway, or arch
Solid panel:	A solid slab, usually of constant thickness.
Soundness:	The freedom of a solid from cracks, flaws, fissures, or variations from an accepted standard, in the case of a cement, freedom from excessive volume change after setting; in the case of aggregate, the ability to withstand the aggressive action to which concrete containing it might be exposed, particularly that due to weather.
Spacer:	Device that maintains reinforcement in proper position, also a device for keeping wall forms apart at a given distance before and during concreting.
Spacing factor:	An index related to the maximum distance of any point, in a cement paste or in the cement paste fraction of mortar or concrete, from the periphery of an air void; also known as powers' spacing factor.
Spall:	A fragment, usually in the shape of a flake, detached from a larger mass by a blow, by the action of weather, by pressure, or by expansion within the larger mass; a small spall involves a roughly circular depression not greater than 20 mm in depth and 150 mm in any dimension; a large spall, may be roughly circular or oval or in some cases elongated, is more than 20 mm in depth and 150 mm in greatest dimension.
Spalling:	The development of spalls

Span-depth ratio:	The numerical ratio of total span to member depth.
Specific gravity:	<p>The ratio of the mass of a volume of a material at a stated temperature to the mass of the same volume of distilled water at a stated temperature.</p> <p>(1) Apparent specific gravity the ratio of the mass of a volume of the impermeable portion of a material at a stated temperature to the mass of an equal volume of distilled water at a stated temperature.</p> <p>(2) Bulk specific gravity the ratio of the mass of a volume of a material (including the permeable and impermeable voids in the material, but not including the voids between particles of the material), at a stated temperature to the mass of an equal volume of distilled water at a stated temperature,</p> <p>(3) Bulk specific gravity (saturated surface-dry) the ratio of the mass of a volume of a material, including the mass of water within the voids (but not including the voids between particles) at a stated temperature to the mass of an equal volume of distilled water at a stated temperature.</p>
Specific gravity factor:	The ratio of the mass of aggregates (including all moisture), as introduced into the mixer, to the effective volume displaced by the aggregates.
Spiral reinforcement:	Continuously wound reinforcement in the form of a cylindrical helix.
Spirally reinforced column:	A column in which the vertical bars are enveloped by spiral reinforcement, i.e.; closely spaced continuous hooping.
Splice:	Connection of one reinforcing bar to another by lapping, welding mechanical couplers, or other means; connection of welded wire fabric by lapping; connection of piles by mechanical couplers.
Splitting tensile strength:	Tensile strength of concrete determined by a splitting tensile test.
Splitting tensile test, (diametric compression test):	A test for tensile strength in which a cylindrical specimen is loaded to failure in diametric compression applied along the entire length.
Spread footing:	A generally rectangular prism of concrete, larger in lateral dimensions than the column or wall it supports, to distribute the load of a column or wall to the subgrade.
Stain:	Discoloration foreign matter.
Standard curing:	Exposure of test specimens to specified conditions of moisture and temperature.
Standard deviation:	The root-mean-square deviation of individual values from their average.
Standard hook:	A hook at the end of a reinforcing bar made in accordance with a standard.

Static load:	The weight of a single stationary body or the combined weights of all stationary bodies in a structure (such as the load of a stationary vehicle on a roadway); or, during construction, the combined weight of forms, stringers, joists, reinforcing bars, and the actual concrete to be placed.
Static modulus of elasticity:	The value of Young's modulus of elasticity obtained by arbitrary criteria from measured stress-strain relationships derived from other than dynamic loading
Steam curing:	Curing of concrete, mortar, grout or neat-cement paste in water vapor at atmospheric or higher pressures and at temperatures between about 100 & 420°F (40 & 215°C).
Steam-curing cycle:	The time interval between the start of the temperature rise period and the end of the soaking period or the cooling-off period; also, a schedule indicating the duration of and the temperature range of the periods that make up the cycle.
Steam-curing room:	A chamber for steam curing of concrete products at atmospheric pressure.
Stem bars:	Bars used in the wall section of a cantilevered retaining wall or in the webs of a box; when a cantilevered retaining wall and its footing are considered as an integral unit, the wall is often referred to as the stem of the unit.
Stiffness factor:	A measure of the stiffness of a structural member; for a prismatic member, it is equal to the ratio of the product of the moment of inertia of the cross section and the modulus of elasticity for the material to the length of the member.
Stirrup:	A reinforcement used to resist shear and diagonal tension stresses in a structural member, typically a steel bar bent into a U or box shape and installed perpendicular to or at an angle to the longitudinal reinforcement, and properly anchored; lateral reinforcement formed of individual units, open or closed, or of continuously wound reinforcement.
Strain:	The change in length per unit of length, in a linear dimension of a body; a dimensionless quantity which may be measured conveniently in percent, in inches per inch, in millimeters per millimeters, but preferably in millionths.
Strain, unit:	Deformation of a material expressed as the ratio of linear unit deformation to the distance within which that deformation occurs.
Strand:	A pre-stressing tendon composed of a number of wires twisted above center wire or core.
Strength design method:	A design method which requires service loads to be increased by specified load factors and computed nominal strengths to be reduced by the specified phi (ϕ) factors.

Strength reduction factor:	See (\emptyset) factor stress intensity of internal force (i.e., force per unit area) exerted by either of two adjacent parts of a body on the other across an imagined plane of separation; when the forces are parallel to the plane, the stress is called shear stress; when the forces are normal to the plane, the stress is called normal stress; when the normal stress is directed toward the part on which it acts, it is called compressive stress; when the normal stress is directed away from the part on which it acts, it is called tensile stress.
Stress relaxation:	The time-dependent decrease in stress in a material held at constant strain.
Stress-strain diagram:	A diagram in which corresponding values of stress and strain are plotted against each other; values of stress are usually plotted as ordinates (vertically) and values of strain as abscissas (horizontally).
Stringer:	A secondary flexural member which is parallel to the longitudinal axis of a bridge or other structure.
Strip foundation:	A continuous foundation wherein the length considerably exceeds the breadth.
Stucco:	A cement plaster used for coating exterior walls and other exterior surfaces of buildings.
Stud:	(1) Member of appropriate size and spacing to support sheathing of concrete forms; (2) A headed steel device used to anchor steel plates or shapes to concrete members.
Sulfate attack:	Either a chemical or a physical reaction or both between sulfates usually in soil or ground water and concrete or mortar; the chemical reaction is primarily with calcium aluminate hydrates in the cement-paste matrix, often causing deterioration.
Sulfate resistance:	Ability of concrete or mortar to with stand sulfate attack.
Surface moisture:	Free water retained on surfaces of aggregate particles and considered to be part of the mixing water in concrete, as distinguished from absorbed moisture.
Surface texture:	Degree of roughness or irregularity of the exterior surfaces of aggregate particles and also of hardened concrete.
Tamper:	(1) An implement used to consolidate concrete or mortar in molds or forms. (2) A hand-operated device for consolidating floor topping or other unformed concrete by impact from the dropped device in preparation for strike off and finishing; contact surface often consists of a screen or a grid of bars to force coarse aggregates below the surface to prevent interference with floating or troweling.

Tamping:	The operation of consolidating freshly placed concrete by repeated blows or penetrations with a tamper.
Temperature cracking:	Cracking due to tensile failure, caused by temperature drop in members subjected to external restraints or by temperature differential in members subjected to internal restraints.
Temperature stress:	Stress in a structure or a member due to changes or differentials in temperature in the structure or member.
Tempering:	The addition of water and mixing of concrete or mortar as necessary to bring the mixture initially to the desired consistency.
Template:	A thin plate or board frame used as a guide in positioning or spacing form parts, reinforcement, or anchors, also a full-size mold, pattern, or frame, shaped to serve as a guide in forming or testing contour or shape.
Temporary stress:	A stress that may be produced in a precast concrete member, or in a component of a precast concrete member, during fabrication or erection, or in cast-in place concrete structures due to construction or test loadings.
Tendon:	A steel element such as wire, cable, bar rod, or strand, or a bundle of such elements, primarily used in tension to impart compressive stress to concrete.
Tensile strength:	Maximum unit stress that a material is capable of resisting under axial tensile loading; based on the cross-sectional area of the specimen before loading.
Tension reinforcement:	Reinforcement designed to carry tensile stresses such as those in the bottom of a simple beam
Tetra-calcium alumino-ferrite:	A compound in the calcium alumino-ferrite series, having the composition $4\text{CaO} \cdot \text{Al}_2\text{O}_3 \cdot \text{Fe}_2\text{O}_3$, abbreviated C_4AF , which is usually assumed to be the alumino-ferrite present when compound calculations are made from the results of chemical analysis of Portland cement.
Texture:	The pattern or configuration apparent in an exposed surface, as in concrete and mortar, including roughness, streaking, striation, or departure from flatness.
T-head:	In precast framing, a segment of girder crossing the top of an interior column; also, the top of a shore formed with a braced horizontal member projecting on two sides forming a T-shaped assembly.
Thermal conductance:	The property (of a particular body or assembly) measured by the ratio of steady-state heat flux in common between two definite surfaces (time-rate of heat flow per unit area of one surface,

which must be identified to the difference between the average temperatures of the two surfaces).

Thermal conductivity:	The property (of a homogeneous body) measured by the ratio of the steady-state heat flux (time-rate of heat flow per unit area) to the temperature.
Thermoplastic:	Becoming soft when heated and hard when cooled.
Threaded anchorage:	An anchorage device which is provided with threads to facilitate attaching the jacking device and to affect the anchorage
Tie:	(1) Loop of reinforcing bars encircling the longitudinal steel in columns. (2) A tensile unit adapted to holding concrete forms secure against the lateral pressure of unhardened concrete.
Tied column:	A column laterally reinforced with ties.
Torsional stress:	The shear stress on a transverse cross section resulting from a twisting action.
Transfer bond:	In pre-tensioning, the bond stress resulting from the transfer of stress from the tendon to the concrete.
Transfer length:	The length from the end of the member where the tendon stress is zero to the point along the tendon where the pre-stress is fully effective; also called transmission length.
Transfer strength:	The concrete strength required before stress is transferred from the stressing mechanism to the concrete.
Transverse joint:	A joint normal to the longitudinal dimension of a structural element, assembly of elements, slab, or structure.
Transverse pre-stress:	Pre-stress that is applied at right angles to the longitudinal axis of a member of slab.
Transverse reinforcement:	Reinforcement at right angles to the longitudinal reinforcement.
Transverse strength:	See flexural strength and modulus of rupture.
Tremie:	A pipe or tube through which concrete is deposited under water, having at its upper end a hopper for filling and a bail for moving the assemblage.
Tremie Seal:	The depth to which the discharge end of the tremie pipe is kept embedded in the fresh concrete that is being placed; a layer of tremie concrete placed in a cofferdam for the purpose of preventing the intrusion of water when the cofferdam is dewatered.
Trial batch:	A batch of concrete prepared to establish or check proportions of the constituents.

Triaxial Compression Test:	A test in which a specimen is subjected to a confining hydrostatic pressure and then loaded axially to failure.
Triaxial Test:	A test in which a specimen is subjected simultaneously to lateral and axial loads.
Tricalcium Aluminate:	A compound having the composition $3\text{CaOAl}_2\text{O}_3$ abbreviated C_3A .
Tricalcium Silicate:	A compound having the composition 3CaOSiO_2 abbreviated C_3S , an impure form of which (alite) is a main constituent of Portland cement.
Trowel finish:	The smooth or textured finish of an unformed concrete surface obtained by troweling.
Troweling:	Smooth and compacting the unformed surface of fresh concrete by strokes of a trowel.
Troweling Machine:	A motor driven device which operates orbiting steel trowels on radial arms from a vertical shaft.
Tunnel lining:	A structural system of concrete, steel or other materials to provide support for a tunnel for exterior loads, to reduce water seepage, or to increase flow capacity.
Two-way reinforcement:	Reinforcement arranged in bands of bars at right angles to each other.
Two-way system:	A system of reinforcement; bars rods, or wires placed at right angles to each other in a slab and intended to resist stress due to bending of the slab in two directions.
Ultimate design resisting moment:	The moment at which a reinforced concrete section reaches its usable flexural strength, commonly accepted for under-moment at which the concrete compressive strain equals 0.003; an obsolete term.
Ultimate load:	The maximum load that may be placed on a structure or structural element before its failure.
Ultimate moment:	The bending moment at which a section reaches its ultimate usable strength, most commonly the moment at which the tensile reinforcement reaches its specified yield strength; an obsolete term.
Ultimate shear strength:	The loading at a section that result in the member failing in shear.
Ultimate Strength:	The maximum resistance to a load or combination of loadings a member or structure is capable of developing before failure.
Un bonded Member:	A pre-stressed concrete member post-tensioned with tendons that are not bonded to the concrete between the end anchorages after stressing.

Unbonded post tensioning:	Post tensioning in which the tendons are not grouted after stressing.
Un bonded tendon:	A tendon that is permanently prevented from bonding to the concrete after stressing.
Unbraced length of column:	Distance between lateral support.
Undersize:	Particles of aggregate passing a designated sieve.
Unit water content:	The quantity of water per unit volume of freshly mixed concrete, often expressed as pounds or gallons per cubic yard; the quantity of water on which the water cement ratio is based, not including water absorbed by the aggregate.
Volume change, autogenous:	change in volume produced by continued hydration of cement, exclusive of effects of applied load and change in either thermal condition or moisture content.
Warping:	A deviation of a slab or wall surface from its original shape, usually caused by either temperature or moisture differentials or both within the slab or wall.
Warping joint:	A joint with the sole function of permitting warping of pavement slabs when moisture and temperature differentials occur between the top and bottom of the slabs. i.e. longitudinal or transverse joints with bonded steel or tie bars passing through them.
Water cement ratio:	The ratio of the amount of water, exclusive only of that absorbed by the aggregate, to the amount of a cement in a concrete, mortar, grout, or cement paste mixture, preferably stated as a decimal by mass and abbreviated w/c.
Water repellent:	Property of a surface that resist wetting (by matter in either liquid or vapor state) but permits passage of water when hydrostatic pressure occurs.
Water void:	Void along the underside of an aggregate particle or reinforcing steel which formed during the bleeding period; initially filled with bleed water.
Wearing course:	A topping or surface treatment to increase the resistance of a concrete pavement or slab to abrasion.
Web reinforcement:	Reinforcement placed in a concrete member to resist shear and diagonal tension.
Wedge anchorage:	A device for providing the means of a coring tendon by wedging.
Weigh batching:	Measuring the constituent materials for mortar or concrete by weight.

Welded-butt splice:	A reinforcing bar splice made by welding the butted ends.
Welded reinforcement:	Reinforcement joined together by welding
Welded-wire fabric:	A series of longitudinal and transverse wires arranged substantially at right angles to each other and welded together at all points of intersection.
Welded-wire fabric reinforcement:	Welded-wire fabric in either sheets or rolls, used to reinforce concrete.
Wet-cast process:	A process for producing concrete items such as pipe that uses concrete having a measurable slump, generally placed from above, and consolidated by vibration.
Wetting agent:	A substance capable of lowering the surface tension of liquids, facilitating the wetting of solid surfaces and permitting the penetration of liquids into the capillaries.
Working stress:	Maximum permissible design stress using working-stress design methods.
Working-stress design:	A method of proportioning either structures or members for prescribed service loads at stresses well below the ultimate, and assuming linear distribution of flexural stresses and strains.
Woven-wire fabric:	A prefabricated steel reinforcement composed of cold drawn steel wires mechanically twisted together to form hexagonally shaped openings.
Yield:	The volume of freshly mixed concrete produced from a known quantity of ingredients; the total weight of ingredients divided by the unit weight of the freshly mixed concrete; also, the number of units produced per bag of cement or per batch of concrete.
Yield point:	That point during increasing stress when the proportion of stress to strain becomes substantially less than it has been at smaller values of stress.
Yield strength:	The stress. Less than the maximum attainable stress, at which the ratio of stress to strain has dropped well below its value at low stresses, or at which a material exhibits a specified limiting deviation from the usual proportionality of stress to strain.
Yoke:	A tie or clamping device around column forms or over the top of wall or footing forms to keep them from spreading because of the lateral pressure of fresh concrete; also, part of a structural assembly for slip forming which keeps the forms from spreading and transfers form loads to the jacks.

6.1.3 Classes of Concrete

6.1.3.1 Normal Weight Concrete

The classes of concrete recognized in these Specifications shall be designated: A, B, C, D1, D2, D3, Y and Lean Concrete. The Class of concrete to be used shall be as called for on the Drawings or as directed by the Engineer or specified in the Special Provisions. The following requirements shall govern unless otherwise shown on the Drawings.

- Class A1 Concrete shall be used everywhere, for non-reinforced and reinforced concrete structures, except as noted below or directed by the Engineer. Concrete placed under water shall be Class A2 with a minimum cement content of 21.85 lbs/cubic feet of concrete with a slump between 10 and 15 cm. Concrete placed for piles shall be class A3 with a minimum cement content of 24.97 lbs/cubic feet.
- Class B concrete shall be used only where specified.
- Class C Concrete shall be used for cribbing, or as otherwise directed by the Engineer or specified in the Special Provisions or on the Drawings.
- Class D1, D2 or D3, Concrete shall be used for pre-stressed and post-tensioned elements, as indicated on drawings.
- Class Y concrete shall be used as filler in steel grid bridge floors, in thin reinforced sections, or as otherwise specified in the Special Provisions.
- Lean concrete shall be used in thin layers underneath footings and when called for on the drawings or directed by the Engineer.

The concrete of the various classes shall satisfy the requirements shown in the Table.

Class of concrete	Min. Cement (lbs/ cubic foot)	Max. size of coarse aggregate (mm)	28 days Compressive Strength		Consistency (Range in Slump) Vibrated (mm)	Max. Permissible water-cement ratio
			(Min.) (cylinder) (kg/sq.cm)	(Min.) (cylinder) (lbs/sq. inch)		
A1	18.73	20	210	3000	25 – 75	0.58
A2	21.85	25	245	3500	100 – 150	0.58
A3	24.97	38	280	4000	100 – 150	0.58
B	15.60	51	170	2418	25 – 75	0.65
C	17.17	38	210	3000	25 – 75	0.58
D1	28.09	25	350	4978	50 – 100	0.40
D2	31.21	25	425	6045	50 – 100	0.40
D3	34.33	25	500	7112	50 – 100	0.40
Y	24.97	13	210	3000	25 – 75	0.58
Lean Concrete	10.92	51	100	1423	-	-

Table 1, Classes of Concrete and their strength (Chapter 6)

6.1.3.2 Lightweight Concrete

Lightweight concrete shall conform to the requirements specified in the special provisions or shown on the plans. When the special provisions require the use of natural sand for a portion or all of the fine aggregate, the natural sand shall conform to AASHTO M 6 (Annex-II).

6.1.4 Materials

6.1.4.1 Cement

Portland cements shall conform to the requirements of Chapter 3 of Book-1 (Specification for Engineering Material).

6.1.4.2 Water

Water for concrete shall conform to the requirement of Chapter 1 of Book-1 (Specification for Engineering Material).

6.1.4.3 Aggregates

1. General Requirements

i) Cleanliness

The aggregates should be free from injurious amount of clay, salt, alkali, organic matter, shale, loam, soft flaky particles and other deleterious substance. Aggregate when not obtained in clean state are invariably washed before use. All deleterious substance shall not exceed 5% in fine aggregates and shall not exceed 3% in coarse aggregate. The extent of these impurities is determined by various field and laboratory tests as described in the testing requirements of fine and coarse aggregates

ii) Shape

Crushed aggregate should be sharp, angular and of hard grains, approximately cubical in size and those obtained from natural source be rounded, well-shaped and of hard grains. The fine aggregate should be such shape that it covers the maximum voids between coarse aggregates.

iii) Size

To obtain high crushing strength of concrete the maximum size of aggregate should be as large as conveniently possible but it should not be normally greater than one-fourth in plain concrete and one-fifth in reinforced concrete of the smallest dimension in the structure. The maximum size of aggregate may be up to 6 ins. For mass concrete, but a size of up to 9 ins. has also been used in dams. Aggregate of size requires carefully designed mixes to avoid segregation and it is probably wise to limit the maximum size to 3 ins. Large stones which are embedded in mass concrete work are called "plums" plums should be sound and hard. The spacing between two plums or a plum and the outer surface should not be less than six inches, for heavily reinforced member the nominal maximum size of aggregate should be $\frac{1}{4}$ in. less than the minimum distance between the reinforcement bars or minimum cover of concrete over the reinforcement whichever is less, provided that the concrete can be placed without difficulty so as to surround all reinforcement thoroughly and fill corners of form work.

Similarly, the nominal maximum size of the aggregates shall not be larger than one fifth of the narrowest dimension of the finished wall or slab, or larger than three fourth of the minimum clear spacing between the reinforcing steel and embedment. These limitations may be waived if, in the judgement of the Engineer-in-Charge, workability and method of consolidation be such that the concrete can be placed without honey-combs or voids.

iv) Grading

Aggregate are required to be graded into different size and mixed in desired proportions for producing mortar and concrete of specified quality and strength. The graded aggregate is one that contains all size of particles between extremes of limits proportions to produce a dense and economical mixture which will use minimum of cement per unit volume to give required strength. The aggregates are graded into minimum of cement per unit volume to give required strength. The aggregates are graded into nominal size by sieving and their fineness Modulus determined. The fineness Modulus is calculated by dividing by 100, the sum of the total, percentage retained on designated sieves in the standard sieve Analysis. A smaller value of the fineness modulus indicated the presence of large proportions of fine particles. The testing requirements are discussed in the relevant sections of testing requirements of fine and coarse aggregates.

v) Durability

Aggregates should be hard to resist grading actions; tough to withstand impact and sound to remain whole during changes in weather conditions. The resistance to grinding action is determined by Los Angeles Abrasion Test. The soundness test is carried out by means of Sodium Sulphate Test. Crushing strength test is carried out to determine the strength. The specific gravity test is required to determine the density. The testing requirements are discussed in the relevant sections of testing requirements of fine and coarse aggregates.

vi) Storage

Storing on dusty, muddy or grassy spots, should be avoided. Dump must be protected from exposure to dust. Old steel sheet or wooden planks may be used as platforms for storage. On large works storage bins and usually used. Aggregate which has deteriorated or which has been contaminated shall not be used for concrete.

vii) Composition

The use of natural sand or a combination of natural and manufactured sand may be permitted, provided that the fine aggregate meets the applicable requirements of the Specifications for the particular use intended. Coarse aggregate shall consist of gravel, crushed stone or a combination thereof. The aggregates shall be non-alkaline reactive in accordance with the provisions of ASTM C- 227, C-289.

viii) Source

The Contractor shall obtain concrete aggregate from deposits of natural sand and gravel or shall procure crushed aggregate from approved quarries (refer to construction material source study) which produce aggregates meeting with the Specifications contained herein.

ix) Processed Aggregates

The Contractor in procuring the processed aggregates or in planning his aggregate processing operations shall ensure that the aggregates, as delivered to the mixer, consist of clean, hard and uncoated particles; light weight elements (chalk, clay, coal) are separated by segregation under water by vibration where required and the fines are removed from the coarse aggregate by adequate washing. The coarse aggregate shall be re-screened just prior to delivery to the concrete mixer bins. The moisture content of coarse and fine aggregates shall be as directed by the Engineer-in-Charge. Compliance with the aggregate grading and uniformity requirements shall be determined before the material is delivered at the mixer. All aggregates shall be sieved and washed with clean water. The aggregates shall conform to the specific requirements given hereinafter.

2) Test Requirements for Fine Aggregate

The fine aggregate shall consist of sand, stone screenings or other approved inert materials with similar characteristics, or a combination thereof, having clean, hard, strong, sound, durable, uncoated grains free from injurious amount of dust, lumps, soft or flaky particles, shale alkali, organic matter, material reactive with alkalis in the cement loam or other deleterious substances and shall not contain more than three (3) % of material passing the No. 200 sieve by washing nor more than one percent of clay lumps or one (1) % of shale. For exposed work, the fine aggregate shall be free from any substance that will discolor the concrete surface. The fine aggregate shall be uniformly graded and when tested in accordance with AASHTO T 11 and T 27 shall meet the following grading requirements: -

Sieve Designation	Percentage Passing by Weight
3/8 inch	100
No.4	95~100
No.16	45~85
No. 50	10~30
No. 100	2~10
No. 200	0~3

Table 2, Grading of Fine Aggregates (Chapter 6)

Fine concrete aggregate shall meet the following requirements. Deleterious substances such as, but not limit to, pyrites, coal or micas shall not exceed two percent (2%) by weight.

Fineness Modulus, AASHTO M6	2.3 to 3.1
Sodium Sulphate Soundness, AASHTO T-104, 5 cycles, percent loss	10 Maximum
Clay Lumps and Friable Particles AASHTO T-112, Percent	1 Maximum
Test for Organic Impurities, AASHTO Than standard T-21	Lighter
Sand Equivalent AASHTO T-176	75 Minimum
Potential Cement – Aggregate Reactivity ASTM C 289, as supplemented by ASTM C 227	Innocuous

Petrographic analysis shall be done against alkali- silica reactivity.

For the purpose of determining the degree of uniformity, a fineness modulus determination shall be made upon representative samples submitted by the Contractor from such sources as he proposes to use. Fine aggregate from any one source having a variation in fineness modulus of greater than 0.20 either way from the fineness modulus of mix design samples submitted by the Contractor may be rejected till new trial mixes are prepared and tested by the Contractor.

i) Sand for Mortar

All sand for mortar used in the construction of brick paving, brick lining and brick masonry shall be natural sand and when tested by means of standard screens (ASTM Designation: E11) shall conform to the following limits: -

Screen No.	Percentage by weight, passing screen
8	100
100	15 (Maximum)

Table 3, Grading of Sand (Chapter 6)

Within the above range, the sand shall be well-graded and as coarse as practicable for the production of workable mortar.

3) Test Requirements for Coarse Aggregates (Aggregates)

The coarse aggregate shall consist of crushed or broken stone, gravel or other approved inert materials with similar characteristics, or a combination thereof, having clean, hard, strong, sound, durable uncoated particles, free from injurious amount of soft, friable, thin elongated, or laminated pieces, alkali, organic or other deleterious matter and conforming to the requirements of these Specifications.

The coarse aggregate shall be of uniform grading with maximum sizes as required for the various classes of concrete as shown in Table-2 'Grading of Coarse Aggregates' and when tested in accordance with AASHTO T 11 & T 27 shall meet the following grading requirements.

Designated Sizes	Percentage by Weight Passing Laboratory Sieves, in inches, Having Square Openings							
	2 ½	2	1 ½	1	¾	½	3/8	No. 4
½" to No. 4	-	-	-	-	100	90~100	40~70	0~15*
¾" to No. 4	-	-	-	100	90~100	-	20~55	0~10*
1" to No. 4	-	-	100	95~100	-	25~60	-	0~10*
1½" to No. 4	-	100	95~100	-	35~70	-	10~30	0~5
2" to No. 4	100	95~100	-	35~70	-	10~30	-	0~5
1½" to ¾"	-	100	90~100	20~55	0~15	-	0~5	-
2" to 1"	100	90~100	35~70	0~15	-	0~5	-	-

Table 4, Grading of Coarse Aggregates (Chapter 6)

- Not more than five (5) % shall pass No. 8 sieve.

Coarse aggregate gradation should conform to the requirements of ASTM C 33. Coarse aggregate shall contain no more than one (1) % by weight of material passing the No. 200 sieve by washing and not more than five (5) % of soft fragments.

It shall have an abrasion loss of not more than forty (40) % at five hundred (500) revolutions, when tested in accordance with AASHTO T 96.

When tested in accordance with AASHTO T 104, for five cycle, the loss with the sodium sulphate soundness test shall be not more than 12 percent.

Natural aggregates shall be thoroughly washed before use.

The aggregate shall be non-alkali/silica reactive where the concrete is to be poured under water or exposed to humid conditions. In case the Contractor proposes to use the aggregate having the alkaline/siliceous characteristics with the intention to use it with Blast Furnace Slag Cement, he will undertake to carry out the job without any extra cost and shall arrange to conduct the necessary tests as directed by the Engineer in Charge.

Coarse aggregate shall not contain materials such as iron pyrites, coal, mica, laminated materials or other materials which may adversely affect the strength and durability of the concrete.

Coarse aggregates shall meet the following requirements: -

Sodium Sulphate Soundness, AASHTO T-104

5 cycles, percent loss 12 Maximum

Clay Lumps and Friable Particles AASHTO
T-112, Percent 1 MaximumSoft Fragments and Shale, AASHTO
M-80, Percent 5 Maximum

Flakiness Index BS 812: Part 105: Section 105.1 15

Potential Cement – Aggregate Reactivity
ASTM C 289, as supplemented by ASTM
C 227 Innocuous

Petrographic examination and description, including approximate composition against alkali-silica reactivity shall be done as per ASTM C 295. Under no circumstances shall the contractor use Dacite Andesite Hyolite, Opal Cherts or Tuffs.

4) Tests & Approval

All aggregates shall be subject to testing which shall be carried out by the contractor at his own expense upon instructions of Engineer-in-Charge. Aggregates not meeting the requirements of these Specifications as determined by tests or inspection may be rejected.

Sr No.	Nominal Size (Sieves with Square Openings)	Amounts Finer than Each Laboratory Sieve (Square openings) Weight Percentage												
		4"	3 1/2 "	3"	2 1/2"	2"	1 1/2"	1"	3/4"	1/2"	3/8"	No. 4	No. 8	No. 100
1	3 1/2" to 1 1/2"	100	90 to 100	-	25 to 60	-	0 to 15	-	0 to 5	-	-	-	-	-
2	2 1/2" to 1 1/2"	-	-	100	90 to 100	35 to 70	0 to 15	-	0 to 5	-	-	-	-	-
3	2" to 1"	-	-	-	100	90 to 100	35 to 70	0 to 15	-	0 to 5	-	-	-	-
4	2" to No. 4	-	-	-	100	100	-	35 to 70	-	10 to 30	-	0 to 5	-	-
5	1 1/2" to 3/4"	-	-	-	-	100	90 to 100	20 to 55	0 to 15	-	0 to 5	-	-	-
6	1 1/2" to 3/4"	-	-	-	-	-	95 to 100	-	35 to 70	-	10 to 30	0 to 5	-	-
7	1" to 1/2"	-	-	-	-	-	100	90 to 100	20 to 55	0 to 10	0 to 5	-	-	-
8	1" to 3/4"	-	-	-	-	-	100	90 to 100	40 to 85	10 to 40	0 to 15	0 to 5	-	-
9	1" to No.4	-	-	-	-	-	100	95 to 100	-	25 to 60	-	0 to 10	0 to 5	-
10	3/4" to 3/8"	-	-	-	-	-	-	100	90 to 100	20 to 55	0 to 15	0 to 5	-	-
11	3/4" to No.4	-	-	-	-	-	-	100	90 to 100	-	20 to 55	0 to 10	0 to 5	-
12	1/2" to No.4	-	-	-	-	-	-	-	100	90 to 100	40 to 70	0 to 15	0 to 5	-
13	3/8" to No.8	-	-	-	-	-	-	-	-	100	85 to 100	0 to 30	0 to 10	0 to 5

Table 5, Grading Requirements for Coarse Aggregate, ASTM C-33-03 (Chapter 6)

4) Water

The water for curing, for washing aggregates and for mixing shall be subject to the approval of the Engineer in charge. Generally, it should be free from oil and the turbidity limit shall not exceed 2000 parts per million and the pH value shall range between 6.0 to 8.0.

In no case shall the water contain an amount of impurities that will cause a change in the setting time of Portland cement of more than twenty-five (25) % nor a reduction in the compressive strength of mortar at fourteen (14) days of more than five (5) % when compared to the result obtained with distilled water.

The water shall be free from oil, alkali, vegetable matter, salt and other impurities. If the specific conductance is less than fifteen hundred (1500) microhms per centimeter, the total solids content requirement may be waived. Water for washing aggregates, mixing, and curing shall contain no chlorides as Cl, nor sulfates as exceeding the values for the type of the work as follows: -

Type of Work	Chlorides (Parts per million)	Sulphates (Parts per million)
Conventionally Reinforced	500	1000
Pre-stressed Concrete	500	1000

Table 6, Water Requirement (Chapter 6)

In non-reinforced concrete work, the water for curing, for washing aggregates and for mixing shall be free from oil and shall not contain more than two thousand (2,000) parts per million of chlorides nor more than one thousand five hundred (1,500) parts per million of sulfates as SO₄.

In addition to the above requirements, water for curing concrete shall not contain any impurities in a sufficient amount to cause discoloration of the concrete or produce etching of the surface.

When required by the Engineer in charge, the quality of the mixing water shall be determined by the Standard Method of Test for Quality of Water to be used in concrete, AASHTO T 26.

i) Combined Aggregate

The coarse and fine aggregate shall be combined in the proportions according to the approved trial mixes for each class of concrete.

Changes from one gradation to another shall not be made during the progress of the work unless approved by the Engineer in Charge, and shall meet the following requirements for the combined aggregate: -

Material passing the 200 sieves by weight	3% Maximum
Water soluble Chlorides	0.04%Maximum
Water soluble Sulphates	
Pre-stressed concrete	0.05% Maximum
Reinforced concrete	1.0% Maximum
Non-reinforced concrete	2.0%

The water-soluble chlorides and sulfates limits specified for the fine and coarse-aggregate individually, are subject to the following overriding requirement: -

The total water-soluble chloride content (AASHTO T 260) in any mix from all sources, including any chloride present in other materials and the mixing water, shall not exceed the following limits as a percentage of the weight of cement in the mix.

Reinforced concrete in humid environment and exposed to chloride	0.1%
------------------------------------------------------------------	------

Reinforced concrete in humid environment but not exposed to chloride	0.15%
----------------------------------------------------------------------	-------

Pre-stressed concrete	0.06%
-----------------------	-------

In case of any likelihood of alkali reactivity the following further tests shall be conducted, as soon as practicable after the Contract is awarded to the Contractor.

(a) Potential Reactivity Tests

- Gel Pat Test
- ASTM Test C 289 (Standard Test Method for Potential Alkali-Silica Reactivity of Aggregates- Chemical Method)
- ASTM Test C 227 (Standard Test Method for Potential Alkali-Silica Reactivity of Aggregates –Mortar Bar Method)

(b) Shrinkage

The properties of the aggregates shall be such that Drying Shrinkage of concrete prepared and tested in accordance with the United Kingdom Building Research Station Digest No 35 (second series) shall not exceed forty-five thousandths percent (0.045%). The initial Drying Shrinkage of all the proposed concrete mixes prepared and tested in accordance with BS 1881 shall not exceed six hundredths percent (0.06%).

(c) Reactivity

Aggregates for use in concrete or mortar that will be subject to wetting, extended to humid atmosphere, or contact with moist ground, shall not contain any materials that are deleteriously reactive with the alkalis in the cement, or any which may be additionally present in the aggregates and mixing water or water in contact with the concrete or mortar, in amounts sufficient to cause excessive localized or general expansion of concrete or mortar.

6.1.4.4 Lightweight Aggregate

Lightweight aggregate for concrete shall conform to the requirements of ASTM C-330.

6.1.4.5 Air-Entraining and Chemical Admixtures

- Air-entraining admixtures shall conform to the requirements of ASTM C-260 and Chemical admixtures shall conform to the requirements of ASTM C-494. Unless otherwise specified, only approved admixtures should be used.
- Classification of admixtures as per ASTM C-494 is given as under:
 1. Type A Water Reducing (Normal Plasticizing)
 2. Type B Retarding
 3. Type C Accelerating

- | | |
|-----------|---------------------------------------------------|
| 4. Type D | Water Reducing and Retarding |
| 5. Type E | Water Reducing and Accelerating |
| 6. Type F | High Range, Water Reducing or Super Plasticizing. |
| 7. Type G | High Range, |

- Admixtures containing chloride ion (Cl) in excess of 1% by weight of the admixture shall not be used in reinforced concrete. Admixtures in excess of 0.1% shall not be used in pre-stressed concrete.
- A Certificate of Compliance signed by the manufacturer of the admixture shall be furnished to the Engineer for each shipment of admixture used in the work. Said Certificate shall be based upon laboratory test results from an approved testing facility and shall certify that the admixture meets the above specifications.
- If more than one admixture s used, the admixtures shall be compatible with each other and shall be incorporated into the concrete mix in correct sequence so that the desired effects of all admixtures are obtained.
- Air-entraining and chemical admixtures shall be incorporated into the concrete mix in a water solution. The water so included shall be considered to be a portion of the allowed mixing water.

6.1.4.6 Mineral Admixtures

Fly ash pozzolans and calcined natural pozzolans for use as mineral admixtures in concrete shall conform to the requirements of ASTM C-618. The use of fly ash as produced by plants that utilize the limestone injection process or use compounds of sodium, ammonium or Sulphur, such as soda ash, to control stack emissions shall not be used in concrete. A certificate of Compliance, based on test results and signed by the producer of the mineral admixture certifying that the material conforms to the above specifications, shall be furnished for each shipment used in the work.

6.1.4.7 Steel

Materials and installation of reinforcing and pre-stressing steel shall conform to the requirements 6.19 of these specifications.

6.1.4.8 Dry Ramming of Brick or Stone Ballast

6.1.4.8.1 Brick Ballast

The brick ballast, wherever specified for use in concrete shall be obtained by breaking bats of 1st class well burnt bricks to the specified sizes usually 1½ inches to 2 inches (40 mm to 50mm). They shall be screened through the appropriate sieves to remove dust and under size ballast.

1. Placing & Ramming of Brick Bat

Wherever brick bats are specified for placement in foundations to provide a firm base, the ballast from pre-approved stacks shall be placed evenly in layers, not exceeding 6 inches (15 cm) thickness in the foundation trench and thoroughly consolidated by means of small plate compactor (may be hand operated) or square rammer. If required/directed by the Engineer in-Charge small quantity of water may be sprinkled on the brick ballast by means of can fitted with hose. The quantity of water will be just enough to facilitate the consolidation and it should not make the foundation muddy.

6.1.4.8.2 Stone Ballast

The stone ballast, wherever specified for use in concrete shall be obtained from the approved quarry to the specified sizes usually ¼" inches to 2 inches. They shall be screened through the appropriate sieves to remove dust and under size ballast.

1. Breaking

Ballast should be broken according to the specified sizes and should be avoided from larger sizes and very small sizes. Range for size of ballast should be from 1/8" to 2".

2. Screening

Screening of stone ballast should be done under the supervision of engineer in charge and only that material should be selected which fully fills the stone size requirement for any specified project.

3. Stacking

Stacking on dusty, muddy or grassy spots, should be avoided. Stack size should be normal and contained in specified area. Wooden planks or any other suitable material should be used to make boundaries of stack pile.

6.2 Proportioning of Concrete

6.2.1 Mix Design

6.2.1.1 Responsibility and Criteria

- The contractor shall be responsible for the performance of all concrete mixes used in structures. The mix proportions selected shall produce concrete that is sufficiently workable and finish able for all uses intended and shall conform to the requirements in table 1- Portland Cement Concrete Requirements and all other requirements of this section. For normal weight concrete the absolute volume method such as described in American Concrete Institute Publication 211.1, shall be used in selecting mix proportions. For structural lightweight concrete, the mix proportions shall be selected on the basis of trial mixes with the cement factor rather than the water/cement ratio being determined by the specified strength using methods such as those described in American Concrete Institute Publication 211.2.
- The mix design shall be based upon obtaining an average concrete strength sufficiently above the specified strength so that, considering the expected variability of the concrete and test procedures, no more than 1 in 10 strength tests will be expected to fall below the specified strength. Mix designs shall be modified during the course of the work when necessary to ensure compliance with strength and consistency requirements.

6.2.1.2 Trail Batch Tests

For classes of concrete contained in table 1- Portland Cement Concrete Requirements, for lightweight concrete and for other classes of concrete when specified or ordered by the Engineer satisfactory performance of the proposed mix design shall be verified by laboratory tests on trial batches. The results of such tests shall be furnished to the Engineer by Contractor or the manufacturer of precast elements at the time the proposed mix design is submitted. For mix design approval, the strengths of a minimum of five test cylinders taken from a trial batch shall average at least 800 psi greater than the specified strength. If materials and a mix design identical to those proposed for use have been used on other work, within the previous year, certified copies of concrete test results from this work which indicate full compliance with these specifications may be substituted for such laboratory tests. If the results of more than 10 such strength tests are available from historical records for the past year, average strength for these tests shall be at least 1.28 standard deviations above the specified strength.

6.2.1.3 Approval

All mix designs, and any modifications thereto shall be approved by the Engineer prior to use. Mix design data provided to the Engineer for each class of concrete required shall include the name, source, type, and brand of each of the materials proposed for use and the quantity to be used per cubic meter of concrete.

6.2.1.4 Water Content

For calculating the water/cement ratio of the mix, the weight of the water shall be that of the total free water in the mix which includes the mixing water, the water in any admixture solutions and any water in the aggregates in excess of that needed to reach a saturated surface-dry condition. The amount of water used shall not exceed the limits listed in table 1- Portland Cement Concrete Requirements and shall be further reduced as necessary to produce concrete of the consistencies listed in table given below at the time of placement:

Type of Work	Nominal Slump Inches	Maximum Slump Inches
Formed Elements: Sections Over 12" thick	1-3	5
Sections 12" thick or Less	1-4	5
Cast-in-place Piles and Drilled Shafts not Vibrated	5-8	9
Concrete Placed under Water	5-8	9

Table 7, Slump Requirements (Chapter 6)

When Type F or G high range water reducing admixtures are used, the above listed slump limits may be exceeded as permitted by the Engineer. When the consistency of the concrete is found to exceed the nominal slump, the mixture of subsequent batches shall be adjusted to reduce the slump to a value within the nominal range. Batches of concrete with a slump exceeding the maximum specified shall not be used in the work. If concrete of adequate workability cannot be obtained by the use of the minimum cement content allowed, the cement and water content shall be increased without exceeding the specified water/cement ratio, or an approved admixture shall be used.

6.2.1.5 Cement Content

The minimum cement content shall be as listed in table 1- Portland Cement Concrete Requirements or otherwise specified. The maximum cement or cement plus mineral admixture content shall not exceed 30 lbs./Cft or 800 pounds per cubic yard of concrete. The actual cement content used shall be within these limits and shall be sufficient to produce concrete of the required strength and consistency.

6.2.1.6 Mineral Admixture

Mineral admixtures shall be used in the amounts specified. In addition, when either Types I, II, IV, or V, cements are used and mineral admixtures are neither specified nor prohibited, the Contractor will be permitted to replace up to 20% of the required Portland cement with a mineral admixture. The weight of the mineral admixture used shall be equal to or greater than the weight of the Portland cement replaced. In calculating the water/cement ratio of the mix, the weight of the cement shall be considered to be the sum of the weights of the Portland cement and the mineral admixture.

6.2.1.7 Air-Entering and Chemical Admixtures

1. Air-entraining admixtures shall conform to the requirements of ASTM C-260 and Chemical admixtures shall conform to the requirements of ASTM C-494. Unless otherwise specified, only Type A (Water reducing), Type B (retarding), Type D (Water reducing and retarding), Type F (Water-reducing, high range) or Type G (Water-reducing, high range and retarding) shall be used. Admixtures containing chloride ion (Cl) in excess of 1% by weight of the admixture shall not be used in reinforced concrete. Admixtures in excess of 0.1% shall not be used in prestressed concrete.
2. A Certificate of Compliance signed by the manufacturer of the admixture shall be furnished to the Engineer for each shipment of admixture used in the work. Said Certificate shall be based upon laboratory test results from an approved testing facility and shall certify that the admixture meets the above specifications.
3. If more than one admixture s used, the admixtures shall be compatible with each other and shall be incorporated into the concrete mix in correct sequence so that the desired effects of all admixtures are obtained.

4. Air-entraining and chemical admixtures shall be incorporated into the concrete mix in a water solution. The water so included shall be considered to be a portion of the allowed mixing water.

6.2.2 Water Cement Ratio Law

The first and most important law upon which the design of concrete mixture is based describes the relationship between the properties of the hardened concrete and the quantity of mixing water used, and was enunciated in 1918 by Duff Abrams. This law may be stated as follows: For plastic mixture, using sound and clean aggregate, the strength and other desirable properties of concrete under given job condition are governed by the net quantity of mixing water used per bag of cement.

The law, known as the water-cement ratio law, was first established with respect to compressive strength. Subsequent studies, however, have shown that it applies equally well to flexural and tensile strength, to the resistance of concrete to wear, and do the bond between concrete and steel. Still more recent investigations have established that the properties of water-tightness and resistance to weathering are in the same way controlled by the proportion of water to cement. It should be noted that in the statement of water cement ratio law, its application is limited to plastic mixtures and to give job conditions. In the laboratory studies leading to the discovery of this principle it was found that, the mixtures were of such consistency that they could be readily molded into a dense, compact mass, the strength result did not confirm to the general relationship. Likewise, in the studies of water-tightness, it was found that unless the mixture were easily placeable and were at the same time not so fluid as to segregate in placing, no regular relationship existed between water-tightness and quantity of mixing water. The need for this plastic consistency during construction is just as important as in laboratory studies if the concrete in the Structure is to have the properties for which it is being designed. The reference to given job condition applies to the various conditions peculiar to a job, such as the characteristics of the materials in use, the methods or mixing and handling and the temperature and moisture conditions under which the concrete cures.

It will be seen that the quantity of mixing water governs the quality of the cement paste, upon which in turn depends the properties of the hardened concrete. The quantity of fine and coarse aggregate does not affect the strength of the concrete, provided of course the concrete is truly plastic and workable. As aggregate is cheaper than cement paste, it is economical to use as much aggregate as possible. However, the greater the quantity of aggregate the greater the stiffness of the concrete, which makes it more difficult and costlier to place properly in the forms. This fact must be kept in mind when estimating the economic advantage of adding aggregate in order to save cement.

Designing a concrete mix; therefore, consists of two operations:

- To select the water-cement ratio which will produce concrete of the desired durability and strength, and
- To find the most suitable combination of aggregates, this will give the best results.

i. Selection of Water-Cement Ratio

The selection of water cement ratio as a basis for designing a concrete mixture involves consideration of both the degree of exposure to which the concrete is to be subjected and the strength requirements of the structure. Because of the high strengths that are now obtained with Portland cement, it is possible to provide ample strength for most exposed structures, if the requirements of exposure are properly cared for. For this reason, the first step in designing mixtures should be to select the water cement ratio necessary to meet the degree of exposure. On any specific job the relationship between the water-cement ratio and strength should be determined by a series of tests.

If it is not possible to carry out tests and plot a job curve, the water-cement ratio required for a given strength may be determined. The engineer must, however, use his discretion as to what values he would use bearing in mind his particular job conditions. There is generally a very considerable variation in the strength of concrete obtained in the field, the amount of variation depending principally upon the accuracy of the batching and control operations and on the uniformity of the raw material used.

ii. Consistency of Concrete

The next consideration in the design of a concrete mix is its handling and placing requirements. In describing the character of fresh concrete, three terms are most often used consistency, plasticity and workability.

Consistency is a general term referring to the state of fluidity from the driest to the wettest possible mixtures. It requires a qualifying term for definiteness.

The term plasticity is used to describe a consistency of concrete which can be readily molded but which permits the fresh concrete to change form slowly if the mold is removed. A plastic mass does not crumble but flows sluggishly without segregation as in water mixtures. Thus, neither the very dry, crumbly mixes nor the very fluid, watery mixes have plastic consistency. The term workability is used to describe the ease or difficulty with which concrete is placed between the forms. In this respect the various conditions under which concrete is placed size and shape of the member, space between reinforcement bars or other details interfering with the ready filling of the forms have to be taken into account. A stiff plastic mixture with large aggregate which is workable in an open form would not be workable, for example, in a thin wall with complicated reinforcement details.

Under conditions of uniform operation, however, changes in consistency as indicated by the slump are useful in showing changes in the character of the material, the proportions, or in the water-cement ratio.

iii. Unit Water Content

For a given set of materials and water cement ratio, the unit water content (water required per cubic yard of concrete) is another important, basic factor affecting the quality of concrete. In 1929 F.R McMillan called attention to the fact that the consistency of a concrete mix for given type and grading of aggregates, is determined by the water-content, and remains very nearly constant regardless of the richness of cement content.

As it will be seen later, the rule finds application in the adjustment of concrete mixes. When the trial mix has been brought to the required slumps the water-cement ratio is usually different from the one stipulated. As cement content is inversely proportional to the water-cement ratio, an increase in water-cement ratio will mean that a part of the cement should be replaced by an equal solid volume of aggregate. The method is reversed if the water-cement ratio is to be decreased.

6.2.3 Volumetric Proportions (Cement: Sand: Aggregate)

1. 1:1:2

Concrete made by using Ordinary Portland Cement (OPC) and other basic ingredients i.e. coarse aggregate, fine aggregate and water. The concrete having Volumetric proportions of 1:1:2 (1 Cement: 1 Fine Aggregate: 2 Coarse Aggregate). Nominal 28 days Cylinder Compressive Strength of such concrete is **28 MPa (4000 psi)**. However, it may vary depending on physical and chemical properties of aggregates.

2. 1:1.5:3

Concrete made by using Ordinary Portland Cement (OPC) and other basic ingredients i.e. coarse aggregate, fine aggregate and water. The concrete having Volumatic proportions of 1:1.5:3 (1 Cement: 1.5 Sand: 3 Aggregate). Nominal 28 days Cylinder Compressive Strength of such concrete is 21 MPa (3000 psi). However, it may vary depending on physical and chemical properties of aggregates. It shall be used for structural members (RCC slabs, beams, columns, walls, partitions etc.) or any other structural work where such strength is specified by the designer.

3. 1:2:4

Concrete made by using Ordinary Portland Cement (OPC) and other basic ingredients i.e. coarse aggregate, fine aggregate and water. The concrete having Volumatic proportions of 1:2:4 (1 Cement: 2 Sand: 4 Aggregate). Nominal 28 days Cylinder Compressive Strength of such concrete is 16.5 MPa (2400 psi). However, it may vary depending on physical and chemical properties of aggregates. It shall be used for structural members (RCC slabs, beams, columns, walls, partitions etc.) or any other structural work where such strength is specified by the designer.

4. 1:3:6

Concrete made by using Ordinary Portland Cement (OPC) and other basic ingredients i.e. coarse aggregate, fine aggregate and water. The concrete having Volumatic proportions of 1:3:6 (1 Cement: 3 Sand: 6 Aggregate). Nominal 28 days Cylinder Compressive Strength of such concrete is 10.5 MPa (1500 psi). However, it may vary depending on physical and chemical properties of aggregates. It shall be generally used for some structural members like foundation, hard standings, concrete blocks etc., and any other works where such strength is specified.

5. 1:4:8

Concrete made by using Ordinary Portland Cement (OPC) and other basic ingredients i.e. coarse aggregate, fine aggregate and water. The concrete having Volumatic proportions of 1:4:8 (1 Cement: 4 Sand: 8 Aggregate). Nominal 28 days Cylinder Compressive Strength of such concrete is 8 MPa (1200 psi). However, it may vary depending on physical and chemical properties of aggregates. It shall be used for no structural works like floor underlay, lean concrete etc.

6.3 Manufacture of Concrete

The production of ready-mixed concrete shall conform to the requirements of ASTM C-94, and the requirements of the Heading 6.5.1 of these specifications. The production of concrete with stationary mixers shall conform to the applicable requirements of ASTM C-94 and the requirements of this article.

6.3.1 Storage of Aggregate

The handling and storage of concrete aggregates shall be such as to prevent segregation or contamination with foreign materials. The methods used shall provide for adequate drainage so that the moisture content of the aggregates is uniform at the time of batching. Different sizes of aggregate shall be stored in separate stock piles sufficiently removed from each other to prevent the material at the edges of the piles from becoming intermixed. When specified in table 1 (page 339) or in the special provisions, the coarse aggregate shall be separated into two or more sizes in order to secure greater uniformity of the concrete mixture.

6.3.2 Storage of Cement

The contractor shall provide suitable means for storing and protecting cement against dampness. Cement which for any reason has become partially set or which contains lumps of caked cement will be rejected. Cement held in storage for a period of over 3 months if bagged or 6 months if bulk, or cement which for any reason the Engineer may suspect of being damaged, shall be subject to a retest before being used in the work. Copies of cement records shall be furnished to the Engineer, showing, in such detail, as he may reasonably require, the quantity used during the day or run at each part of the work.

6.3.3 Measurement of Material

Materials shall be measured by weighing, except as otherwise specified or where other methods are specifically authorized. The apparatus provided for weighing the aggregates and cement shall be suitably designed and constructed for this purpose. Each size of aggregate and the cement shall be weighed separately. The accuracy of all weighing devices shall be such that successive quantities can be measured to within 1% of the desired amount. Cement in standard packages (sack) need not be weighed., but bulk cement shall be weighed. The mixing water shall be measured by volume or by weight. The accuracy of measuring the water shall be within a range of error of not over 1%. All measuring devices shall be subject to approval and shall be tested, at the Contractor's expense, when deemed necessary by the Engineer. When volumetric measurements are authorized for projects, the weight proportions shall be converted to equivalent volumetric proportions. In such cases, suitable allowance shall be made for variations in the moisture condition of the aggregates, including the bulking effect in the fine aggregate.

6.3.4 Batching and Mixing of Concrete

6.3.4.1 Batching

The size of the batch shall not exceed the capacity of the mixer as guaranteed by the manufacturer. The measured materials shall be batched and charged into the mixer by means that will prevent loss of any materials due to effects of wind or other causes.

6.3.4.2 Mixing

1. The concrete shall be mixed only in the quantity required for immediate use. Mixing shall be sufficient to thoroughly intermingle all mix ingredients into a uniform mixture. Concrete that has developed an initial set shall not be used. Re tempering concrete by adding water will not be permitted. For other than transit mixed concrete, the first batch of concrete materials placed in the mixer shall contain a sufficient excess of cement, sand, and water to coat the inside of the drum without reducing the required mortar content of the mix. When mixer performance tests, as described in AASHTO M 157, are not made, the required mixing time for stationary mixers shall be not less than 90 seconds nor more than 5 minutes. The minimum drum revolutions for transit mixers at the mixing speed recommended by the manufacturer shall not be less than 70 and not less than that recommended by the manufacturer.
2. The timing device on stationary mixers shall be equipped with a bell or other suitable warning device adjusted to give a clearly audible signal each time the lock is released. In case of failure of the timing device, the Contractor will be permitted to operate while it is being repaired, provided he furnishes an approved timepiece equipped with minute and second hands. If the timing device is not placed in good working order within 24 hours, further use of the mixer will be prohibited until repairs are made.
3. For small quantities of concrete needed in emergencies or for small noncritical elements of the work concrete may be hand-mixed using methods approved by the Engineer. Between uses, any mortar coating inside of mixing equipment which sets or dries shall be cleaned from the mixer before use is resumed.

6.3.4.2.1 Hand Mixing

Unless otherwise specified or directed, hand mixing shall be done on the following lines: -

- Wooden batch boxes of one to three cubic feet capacity shall be used. Convenient sizes of these boxes are given below: -

Capacity (Cube feet)	Inside Measure (Inches)		
	Length	Breadth	Height
1	12	12	12
1¼	15	15	9 ⁵ / ₈
1½	15	15	11½
1¾	15	15	13½
2	18	18	10 ⁵ / ₈
2¼	18	18	12
2½	18	18	13 ³ / ₈
2¾	18	18	14 ⁵ / ₈
3	18	18	16

Table 8, Sizes of Box (Chapter 6)

- Hand mixing shall only be done on a smooth watertight platform large enough to allow efficient turning over of the various ingredients both before and after the addition of water. The platform shall be wooden and rectangular in shape having close fitting joints between the boards or long sheet iron troughs. The platform shall in no case be utilized for storing material other than that required for immediate mixing.
- Size of each batch shall be regulated by the proportions of the ingredients. A batch mixed at a time shall not contain more than one bag of cement. The approximate yield of concrete per bag of cement and volume of loose materials for various nominal mixes is given in the following table: -

Nominal mix by volume	Volume of fine and coarse aggregate per bag of cement (Cu.ft.)	Yield per bag of cement (Cu.ft.)	Volume of loose materials for 1 bag batch (Cu.ft.)	Minimum size of mixer for 1-bag batch
1:1:2	1¼: 2 ½	3½	5	3½
1:1½ :3	1⅞: 3 ¾	4½	6⅞	5
1:2:4	2½: 5	5¾	8¾	7

Table 9, Approximate yield of concrete per bag of cement and volume of loose materials (Chapter 6)

- In case concreting has to be done at a faster speed different gang of laborers shall prepare different batches at the same time.
- The measured quantity of cement shall be placed on top of the measured quantity of fine aggregate and then both of these shall be mixed dry three times or more till they attain a uniform colour. The measured quantity of Coarse aggregate shall then be added and mixed with it. The required quantity of water, which shall be measured or weight for each batch, shall then be added with a rose. The mixture shall be turned over and the process continued at least three times or till the entire mass has become wet and a homogeneous mixture of the required consistency has been obtained.
- The re-tempering of concrete or mortar which has partially set (that is remixing with or without additional cement aggregate or water is absolutely prohibited. Under no circumstances shall concrete which has partially hardened be deposited in the work.

6.3.4.2.2 Machine Mixing

1. Type and Capacity

All concrete shall be produced in a batching and mixing plant or by means of a mechanical mixer. The capacity of the plant shall be such that the proposed arrangement will produce adequate quantity of concrete to meet with all the other requirements of these Specifications and the construction schedule. The batched materials shall be thoroughly combined into a uniform mixture before the addition of water and admixtures. The water shall be added gradually and the mixer operated for specified duration of time so as to obtain a thoroughly mixed concrete of uniform color and quality.

2. Mixers

The mixers provided by the Contractor shall be capable of combining the materials into a uniform mixture and of discharging without segregation. Mixers shall not be charged in excess of the capacity recommended by the manufacturer and shall not be recharged before completely discharging the previous batches. Over mixing requiring additions of water will not be permitted. The mixers shall be operated at a drum speed designated by the manufacturer. The mixers shall be cleaned frequently and maintained in satisfactory operating condition, and mixer drums shall be replaced when worn down more than 10 percent of their length and or thickness.

3. Water Batcher

A suitable water measuring device shall be provided by the Contractor which shall be capable of measuring water within the specified requirements for each batch. The mechanism for delivering water to the mixer shall be such that no leakage will occur when the valves are closed.

4. Locations

The concrete plant/mixer shall be installed at the Site at locations selected by the Contractor and approved by the Engineer-in-Charge.

5. Arrangement

- Separate bins and compartments shall be provided for each size or type of aggregate and Portland cement. The compartments shall be of adequate size and so constructed that the materials will be maintained separated under all conditions. Batching equipment/arrangement shall be capable of delivering concrete within the following limits of accuracy as shown in Table-10 'Tolerances for Weights of Concrete Batching Ingredients'.

Material	Percent by weight
Cement	±1%
Water	±1%
Aggregate smaller than 19 mm (3/4 inches)	±2%
Aggregate larger than 19 mm (3/4 inches)	±3%

Table 10, Tolerances for Weights of Concrete Batching Ingredients (Chapter 6)

- For volume batching suitable measuring boxes shall be used. The batching should preferably be for one full bag of cement (50 Kgs.) corresponding to a volume of 1¼ Cu.ft. (0.035 Cu.M.) or such other amount as may be determined by the Engineer-in-Charge as a result of tests of bulking effect of aggregates shall be take into consideration.

6. Cooling

Adequate cooling facilities shall be provided to ensure that the temperature of concrete when discharged from the mixers is sufficiently low to meet the temperature requirements as specified below: -

Placing temperature unless otherwise approved by the Engineer-in-Charge shall conform to the requirements herein specified for thin, moderate and mass sections. The Engineer-in-Charge's determination as to the type of section and applicable placing temperatures shall govern. Concrete shall be placed at temperatures as follows: -

a. Thin Sections

Concrete for thin sections shall be delivered to the forms at the coolest temperature which is practicable to produce under current conditions but in no case at a temperature in excess of 30°C. Except as otherwise determined by the Engineer-in-Charge, sections to which this provision shall apply shall be less than 20 inches (50 cms) in thickness.

b. Moderate Sections

Concrete for moderate sections shall have a temperature of not more than 21°C when placed. A moderate section will be one that is greater than twenty inches (fifty centimeters) but less than 40 inches (one meter) in thickness.

c. Mass Concrete Sections

Concrete having a measure of 40 inches (one meter) or more in thickness shall have a temperature not exceeding 18°C.

Cool mixing water, ice, pre-cooled aggregate, shading the stockpiles with roofing or any other arrangements may be used to ensure the pre-cooling of the concrete, subject to the written approval of the Engineer-in-Charge, but approval shall not in any way relieve the Contractor of his responsibility of placing concrete at temperatures at or below the specified limits. The Engineer-in-Charge if required shall order the following to meet the temperature requirements.

- Avoiding the placement of concrete during the hottest part of day.
- Placement only at night.

7. Scales

Adequate weight and volume batching facilities, as approved by the Engineer-in-Charge, shall be provided by the Contractor for the accurate measurement and control of each of the materials entering each batch of concrete. The accuracy of the weighing equipment shall conform to the requirements of applicable standards. The weighing equipment shall be arranged so that the concrete plant operator and Engineer-in-Charge can observe the dials or indicators. Volumetric measurements, if approved by the Engineer-in-Charge, shall be made by means of accurate measuring boxes.

8. Mixing Time

The mixing periods specified in Table –11 ‘Mixing Periods for Concrete’ are based on proper control of the speed of rotation of the mixer in accordance with Plant Manufacturer’s recommendation and of the proper introduction of the materials into the mixer. The mixing time will be increased when such increase is necessary to secure the required uniformity, workability and consistency of the concrete. The mixing time for each batch after solid materials are in the mixer drum, provided that all the mixing water is introduced before one fourth of the mixing time has elapsed, shall be as follows: -

Capacity of	Mixer Mixing Time (Minutes)
Up to 1.5 cubic meters (2 cu.yds)	2.0
from 1.5 to 2.5 cubic meters (2.0 to 3.25 cu.yds)	2.5

Table 11, Mixing Periods for Concrete (Chapter 6)

The time for higher capacity mixing shall be according to plant manufacture’s recommendation.

6.3.5 Transporting Concrete

Concrete should be conveyed according to the requirement of ACI 304. The organization supplying concrete shall have sufficient plant capacity and transporting apparatus to ensure continuous delivery at the rate required. The rate of delivery of concrete during concreting operations shall be such as to provide for the proper handling, placing, and finishing of the concrete. The rate shall be such that the interval between batches shall not exceed 20 minutes and shall be sufficient to prevent joints within a monolithic pour caused by placing fresh concrete against concrete in which initial set has occurred. The methods of delivering and handling the concrete shall be such as will facilitate placing with the minimum of re handling and without damage to the structure or the concrete. The following main requirements should be fulfilled during transporting the concrete:

- 1) Concrete delivered at the point of placing should be uniform and of proper consistency.
- 2) There should be no separation of materials in the concrete.
- 3) Concrete should not dry or stiffen during conveyance.

6.3.5.1 Segregation

The most important consideration in handling and transporting concrete is to avoid the segregation of coarse aggregate from the concrete. It is a common fallacy to say that separation occurring in handling will be eliminated during other operations. Separation must be prevented and not corrected afterwards. The reason why separation occurs is that concrete is not a homogeneous product but a collection of materials widely different in particle, size and gravity. As a result, from the time the concrete leaves the mixer there are internal and external forces which act to separate the dissimilar constituents. Separation can be prevented by ensuring that concrete is dumped or dropped vertically. When dropped at an angle the larger aggregate is thrown to the far side of the container and the mortar is thrown to the near side thus resulting in segregation that may not be corrected upon further handling of the concrete. The prevention of separation must first be ensured at the mixer itself. The segregation of material owing to the uncontrolled chuting of the concrete as it is discharged from the mixer is particularly noticeable with non-tilting mixers where the concrete passes out in relatively small streams over the discharge chute. This can be prevented by providing a down-pipe at the end of the chute so that the concrete drops vertically into the center of the receiving container. With tilting mixers, the batch usually slides out in a bulkier mass and is thus less prone to segregate.

6.3.5.2 Methods of Conveyance

Concrete may have to be deposited below or at about the same level as the mixer; or as in the case of buildings and dams, concrete must be hoisted and distributed above mixer level. There are many devices for conveying concrete, and they are used either single or in combination to suit different conditions.

6.3.5.2.1 Hand Pans, wheelbarrows and Carts

The most common contrivance used in this country for transporting concrete from the mixer to the forms is the hand pan (or taghari), which is passed from hand to hand. This method is tedious, slow, wasteful, and with the rising cost of labor is likely to be expensive. Where concrete is to be deposited at or below the mixer level, it is better to use a steel wheelbarrow. For placing concrete much below the general ground level, as in basement slabs, foundations and footings, a wood or steel chute may be used. Such chutes are made with a flared upper end for convenience in dumping the barrow or cart direct into them. For lifting concrete above the mixer level special provisions have to be made. In a single-storey structure where the concrete has to be lifted not more than 10 or 15 feet above the ground level, inclined runways for wheeling the concrete are easy to build. These runways may be built with one or two landings to break the slope.

6.3.5.2.2 Hoists

For most of the building jobs, however, a hoist of some sort is required. A wooden hoist tower can be made by carpenters, but steel towers have a longer life and can be erected and dismantled with ease. Very often, no special tower is required, a cage being formed from the external scaffolding members to accommodate the hoisting arrangement. Barrows, carts, skips or other containers may be used to convey the concrete.

6.3.5.2.3 Buckets

Steel buckets transported by motor lorries, derricks, or cableways, and frequently by a combination of these, are the most satisfactory methods of conveying concrete over long distances and extensive sites like dams and barrages. They are of varying shape and design

and have capacities ranging from 1 to 8 cubic yards. The larger buckets usually have a rectangular cross-section, but most buckets are circular. The usual method of releasing concrete is by tripping a gate or gates fitted at the bottom of the bucket. The bucket is lowered as closed to the forms as possible or to the surface of the concrete already placed before releasing the concrete to avoid the impact of concrete falling from a height which may not only impair the quality of the concrete, disturbing that already placed, but may seriously damage formwork itself. For use on huge structures, the buckets usually have straight sides and gates opening to the full area of the bottom of the bucket. For smaller formed sections the bucket is provided with a regulating gate of smaller size than the section of the bucket which may be closed at will during unloading so that the remainder of the contents may be deposited elsewhere. Gates maybe operated by hand or by mechanical or pneumatic means. Where the buckets are handled by a cableway, mechanically or pneumatically operated gates are the safest, because they can control the discharge of the concrete in a much better way and thus prevent sudden jerks on the cableway.

6.3.5.2.4 Chutes

Concrete may be distributed by means of long chutes or chute systems for covering fairly large areas, whether at ground level as in reservoir floors, or at various elevations as in large multi-storied buildings. This method may, however, be considered most objectionable because of the tendency of the concrete to segregate and dry. The chutes should be of metal or metal lined, round-bottomed and of ample size to guard against overflow. The slope of the line of chutes has to be so adjusted that the concrete flows regularly, though not so fast as to allow the materials to segregates. The slope depends upon the consistency of the concrete, the nature of materials, and the design of the chutes, but it is generally not flatter than 1 to 3 nor steeper than 1 to 2. The addition extra water to the concrete to enable it to flow down the chutes is, of coarse, not to be allowed. When long chutes are used the concrete is delivered into a hopper, preferably of the bottom gate type before it is deposited into the forms. In this way some remixing action takes place to correct any segregation which may have taken place. If concrete is placed direct in the forms, it should not fall freely more than a few feet and nor shoot out at an angle.

6.3.5.2.5 Conveyor Belts

Belt conveyors should be used to transport plastic concrete that is approximately 48% heavier than aggregate or other commonly conveyed materials. They should transport plastic concrete from a supply source, such as a truck mixer or a batching and mixing plant, to the point of placement or to other equipment that shall be used to place the concrete. It shall require a constant supply of properly mixed concrete for charging the belt conveyor and a provision for moving the discharge point during placement so that the plastic concrete shall be deposited over the entire placement area without the need for re-handling or excessive vibration. Concrete belt conveyors shall be classified into three types: -

- Portable or self-contained;
- Feeder or series;
- Spreader-radial or side-discharge.

All concrete conveyors shall require charge and discharge hoppers, belt wipers, and proper combinations of belt support idlers and belt speed to prevent segregation of the concrete. Normal weight or lightweight aggregate concrete should be placed by a concrete belt conveyor.

6.3.5.2.6 Concrete Pumps

Pipe diameter shall be selected in view of the type and quality of concrete, maximum size of coarse aggregate, pumping conditions, ease of pumping, safety etc. Piping routes should be determined so that the piping distance and the number of bends are minimized. The type and number of concrete pumps shall be determined in view of pumping load, discharge rate, the rate of placement and the environment conditions at the job. The Contractor will be responsible for approval from Engineer in charge.

1. Pumping Equipment

Concrete pumps shall consist of a receiving hopper, two concrete pumping cylinders, and a valving system to alternately direct the flow of concrete into the pumping cylinders, and from them, to the pipeline. One concrete cylinder shall receive concrete from the receiving hopper while the other discharges into the pipeline to provide a relatively constant flow of concrete through the pipeline to the placement area. The price of concrete pumps shall vary greatly with maximum pumping capacity and maximum pressure that shall be applied to the concrete. Pumps should be selected to provide the desired output, volume, and pressure on the concrete in the pipeline.

Concrete pumps should use hydraulically operated concrete valves that should have the ability to crush or displace aggregate trapped in the valve area. These pumps shall have an outlet port 5 in. (125 mm) or larger in diameter and if necessary, shall use reducers to reach smaller pipeline sizes.

Other pumps should use steel balls and mating seats to control the flow of concrete from the hopper into the pumping cylinder and out of the pumping cylinder into the pipeline. These units shall be limited to pumping concrete with smaller than 1/2 in. (13 mm) maximum-sized aggregate. ACI 304.2R shall describe general purpose, medium-duty, and special-application pumps in detail. These should be trailer- or truck-mounted units.

Truck mounted pumps should also be equipped with placement booms that shall support a 5 in. (125 mm) diameter pipeline that shall receive the discharge from a concrete pump and place it in the forms. Most booms shall have three or more articulating sections and shall be mounted on a turret that rotates to enable the discharge of the pipeline to be located where needed. Booms shall be generally rated according to their vertical reach and range in size from about 72 ft to 175 ft (22 to 53 m). Safe operating practices should be necessary for the protection of the pump operator, ready-mixed concrete drivers, and the workers placing and finishing the pumped concrete.

2. Pipeline and Accessories

a. General

Concrete should be transported to the placement area by pumping methods i.e. pump through rigid steel tubing or heavy-duty flexible hose.

For placements on grade, rubber hose should be frequently used at the end of a steel tubing pipeline. Large or elevated placements should be done by placement booms. Following factors shall disturb the smooth flow of pumped concrete.

- Pipeline surface irregularity or roughness
- Diameter variations
- Directional changes

All components of the pipeline should be able to handle, with an adequate safety factor, the maximum internal pressure that the concrete pump being used should be capable of

producing. Straight sections of pipeline shall be made of welded or seamless steel tubing, most commonly 10 ft (3 m) in length. The most common diameters shall be 4 and 5 in. (100 and 125 mm) with most systems in the 5 in. (125 mm) size. Aluminum pipeline should not be used in concrete pumping.

b. Pipeline components

Concrete pipeline components should be assembled in virtually any order, then should be disassembled and reconfigured in a different manner. To achieve this flexibility, each delivery line component shall require the use of connecting ends or collars, a coupling, and a gasket. The coupling connections should require a gasket sealing ring to hold the required pressure and prevent grout leakage. Connecting ends should use a raised section profile to make a joint that shall withstand pressures in excess of 2000 psi (14 MPa). They should also withstand considerable stress from external bending forces. Grooved-end connections should not be used on pipeline with diameter greater than 3 in. (75 mm). Concrete pumping hose shall be divided into two classifications: -

Hose should be used at the end of a placement line (discharge hose) and hose shall be used on a placement boom (boom hose). Discharge hose shall have a lower pressure rating. A boom hose shall typically connect rigid boom sections and should withstand high pressures. Three times more pressure should be required to pump concrete through a given length of hose than needed to pump through the same length of steel line. Pumping pressure must cause a curved or bent hose to straighten. Injuries resulted from such movement, and sharp bends should be avoided. To help achieve maximum component life, safe and thorough cleaning of the pipeline should be necessary at the end of each placement. The pipeline should be cleaned by propelling a sponge ball or rubber go-devil through the line with air or water pressure. Arrangements for disposal of this residual concrete should be made before pumping begins.

3. Proportioning Pumpable Concrete

a. Basic consideration

Ready-mixed concrete producers shall supply a concrete mixture that will pump readily if they shall be informed of the concrete pump volume and pressure capability, pipeline diameter, and horizontal and vertical distance to be pumped. The shape of the coarse aggregate, whether angular or rounded, shall have an influence on the required mixture proportions, although both shapes can be pumped satisfactorily. The angular pieces should have a greater surface area per unit volume as compared with rounded pieces and thus shall require more mortar to coat the surface for pumpability.

b. Coarse aggregate

The maximum size of angular or crushed coarse aggregate should be limited to 1/3 of the smallest inside diameter of the pump or pipeline. For well-rounded aggregate, the maximum size should be limited to 2/5 of these diameters. The principles of proportioning are covered in ACI 211.1 and ACI 211.2. Whereas the grading of sizes of coarse aggregate should meet the requirements of ASTM C 33, it shall be important to recognize that the range between the upper and lower limits of this standard shall be broader than ACI Committee 304 recommended to produce a pumpable concrete.

c. Fine aggregate

Together with the cement and water, the fine aggregate should provide the mortar or fluid that shall convey the coarse aggregates in suspension, thus rendering a mixture pumpable.

Particular attention should be given to those portions passing the finer screen sizes (Anderson 1977). At least 15 to 30% should pass the No. 50 (300 μm) screen and 5 to 10% should pass the No. 100 (150 μm) screen. According to ACI 211.1, for more workable concrete, it must be desirable to reduce the estimated Coarse aggregate content by up to 10%. Exercise caution to ensure that the resulting slump, w/cm, and strength properties of the concrete should meet applicable project specification requirements.

d. Combined normal weight aggregates

The combined coarse and fine aggregates should occupy about 67 to 77% of the mixture volume. For gradation purposes, the fine and coarse aggregates should be considered as one even though proportioned separately. According to ACI 304.2R, an analysis worksheet shall be made for evaluating the pumpability of a concrete mixture by combining the fine and coarse aggregate with nominal maximum-sized aggregate from 3/4 to 1-1/2 in. (19 to 38 mm). The worksheet shall make provision for additional coarse and fine aggregate that should be added to a mixture to improve the overall gradation and shall recognize possible overlap of some coarse and fine aggregate components. If a mixture is known to be pumpable shall be evaluated and graphed first, the curve representing its proportions shall provide a useful reference for determining the pumpability of a questionable mixture. If that mixture has a curve running in a zigzag fashion, or has one or more values falling below the boundary line, the mixture shall be questionable for pumping and may not be pumpable by all types of concrete pumps. Those pumps with powered valves, higher pressure on the concrete, and the most gradual and smallest reduction from concrete tube diameter should pump the most difficult mixtures. Concrete containing lightweight fine and coarse aggregate should be pumped if the aggregate shall be properly saturated.

e. Water

The amount of water used in a mixture will influence the strength and durability (for a given amount of cement) and will also affect the slump or workability. Mixing water requirements shall vary for different maximum sizes of aggregate as well as for different slumps. Slumps from 2 to 6 in. (50 to 150 mm) shall be most suitable for pumping. In mixtures with higher slump, the coarse aggregate should separate from the mortar and paste and could cause pipeline blockage. Slumps obtained through the use of superplasticizers, however, shall be pumped without difficulty.

The slump at the end of the discharge hose should be maintained within specification limitations. It must be satisfactory for the concrete to enter the pump at a higher slump to compensate for slump loss, if the change shall be due to aggregate absorption.

f. Cementitious material

The determination of the cementitious materials content should follow the same basic principles used for any concrete. The use of extra quantities of cementitious materials as the only means to correct pumping difficulties shall be shortsighted and uneconomical. Correcting any deficiencies in the aggregate gradation shall be more important.

g. Admixtures

Any admixture that increases workability in both normal weight and lightweight concretes will usually improve pumpability. Admixtures shall be used to improve pumpability include regular and high-range, water-reducing admixtures, air-entraining admixtures, and finely divided mineral admixtures.

Increased awareness shall be needed to incorporate entrained air in concrete to minimize freezing and thawing damage to structures that shall have coincided with increased use of concrete pumps, as well as the development of longer placement booms. The effectiveness of the air-entraining agent (AEA) in producing a beneficial air-void system shall depend on many factors. The more important factors are: -

- The compatibility of the AEA and other admixtures as well as the order in which they are introduced into the batch;
- The mixture proportions and aggregate gradation;
- Mixing equipment and procedures;
- Mixture temperatures;
- Slump

AEA effectiveness and the resulting dosage of AEA shall also depend on the cement fineness, cement factor, and water content, and the chemistry of cement and water, as well as that of other chemical and mineral admixtures shall be used in the concrete. Air content and admixtures shall refer to ACI 304.2R.

4. Field Practice

Preplanning for concrete pumping shall be essential for successful placements, with increasing detail and coordination required as the size of the placement and the project increases. This planning should provide for the correct amount and type of concrete for the pump being used, provision for necessary pipeline, and agreement as to which personnel will provide the labor necessary to the complete placement operation. Any trailer- or truck-mounted concrete pump should be used for pipeline concrete placement. The limiting factor in this method should be the ability to spread the concrete as needed at the end of the pipeline. Generally, this should be done by laborers using a rubber hose at the end of a rigid placement line. The discharge of powered placement booms should be positioned at almost any point within the radius of the boom and at elevations achieved with the boom from near vertical (up or down) to horizontal. Their use should generally reduce the manpower required for a given placement.

Equipment	Type and range of work for which equipment is best suited	Advantages	Points to watch for
Belt conveyors	For conveying concrete horizontally or to a higher or lower level. Usually positioned between main discharge point and secondary discharge point.	Belt conveyors have adjustable reach, traveling diverter, and variable speed both forward and reverse. Can place large volumes of concrete quickly when access is limited.	End-discharge arrangements needed to prevent segregation and leave no mortar on return belt. In adverse weather (hot, windy) long reaches of belt need cover.
Belt conveyors mounted on truck mixers	For conveying concrete to a lower, horizontal, or higher level.	Conveying equipment arrives with the concrete. Adjustable reach and variable speed.	End-discharge arrangements needed to prevent segregation and leave no mortar on return belt.
Buckets	Used with cranes, cableways, and helicopters for	Enables full versatility of cranes, cableways, and helicopters to be	Select bucket capacity to conform to size of the concrete batch and

	construction of buildings and dams. Convey concrete directly from central discharge point to formwork or to secondary discharge point.	exploited. Clean discharge. Wide range of capacities.	capacity of placing equipment. Discharge should be controllable.
Chutes on truck mixers	For conveying concrete to a lower level, usually below ground level, on all types of concrete construction.	Low cost and easy to maneuver. No power required; gravity does most of the work.	Slopes should range between 1 to 2 and 1 to 3 and chutes must be adequately supported in all positions. End-discharge arrangements (downpipe) needed to prevent segregation.
Cranes and buckets	The right equipment for work above ground level.	Can handle concrete, reinforcing steel, formwork, and sundry items in bridges and concrete-framed buildings.	Has only one hook. Careful scheduling between trades and operations is needed to keep crane busy.
Drop chutes	Used for placing concrete in vertical forms of all kinds. Some chutes are one-piece tubes made of flexible rubberized canvas or plastic, others are assembled from articulated metal cylinders (elephant trunks).	Drop chutes direct concrete into formwork and carry it to bottom of forms without segregation. Their use avoids spillage of grout and concrete on reinforcing steel and form sides, which is harmful when off-the-form surfaces are specified. They also will prevent segregation of coarse particles.	Drop chutes should have sufficiently large, splayed-top openings into which concrete can be discharged without spillage. The cross section of drop chute should be chosen to permit inserting into the formwork without interfering with reinforcing steel.
Mobile batcher mixers	Used for intermittent production of concrete at jobsite, or where only small quantities are required.	A combined materials transporter and mobile batching and mixing system for quick, precise proportioning of specified concrete. One-man operation.	Trouble-free operation requires good preventive maintenance program on equipment. Materials must be identical to those in original mix design.
Non-agitating trucks	Used to transport concrete on short hauls over smooth roadways.	Capital cost of non-agitating equipment is lower than that of truck agitators or mixers.	Concrete slump should be limited. Possibility of segregation. Height is needed for high lift of truck body upon discharge.
Pneumatic guns (Shotcrete)	Used where concrete is to be placed in difficult locations and where	Ideal for placing concrete in free form shapes, for repairing structures, for	Quality of work depends on skill of those using equipment. Only

	thin sections and large areas are needed.	protective coatings, thin linings, and building walls with one-sided forms.	experienced nozzlemen should be employed.
Pumps	Used to convey concrete directly from central discharge point at jobsite to formwork or to secondary discharge point.	Pipelines take up little space and can be readily extended. Delivers concrete in continuous stream. Pump can move concrete both vertically and horizontally. Truck-mounted pumps can be delivered when necessary to small or large projects. Tower-crane mounted pump booms provide continuous concrete for tall building construction.	Constant supply of freshly-mixed concrete is needed with average consistency and without any tendency to segregate. Care must be taken in operating pipeline to ensure an even flow and to clean out at conclusion of each operation. Pumping vertically, around bends, and through flexible hose will considerably reduce the maximum pumping distance.
Screw spreaders	Used for spreading concrete over large flat areas, such as in pavements and bridge decks.	With a screw spreader a batch of concrete discharged from a bucket or truck can be quickly spread over a wide area to a uniform depth. The spread concrete has good uniformity of compaction before vibration is used for final compaction.	Screw spreaders are normally used as part of a paving train. They should be used for spreading before vibration is applied.
Tremies	For placing concrete under- water.	Can be used to funnel concrete down through the water into the foundation or other part of the structure being cast.	Precautions are needed to ensure that the tremie discharge end is always buried in fresh concrete so that a seal is preserved between water and concrete mass. Diameter should be 250 to 300 mm (10 to 12 in.) unless pressure is available. Concrete mixture needs more cement, 390 kg/m ³ (658 lb/yd ³), and greater slump, 150 to 230 mm (6 to 9 in.), because concrete must flow and consolidate without any vibration.
Truck agitators	Used to transport concrete for all uses	Truck agitators usually operate from central	Timing of deliveries should suit job

	in pavements, structures, and buildings. Haul distances must allow discharge of concrete within 1 1/2 hours, but limit may be waived under certain circumstances.	mixing plants where quality concrete is produced under controlled conditions. Discharge from agitators is well controlled. There is uniformity and homogeneity of concrete on discharge.	organization. Concrete crew and equipment must be ready onsite to handle concrete.
Truck mixers	Used to transport concrete for uses in pavements, structures, and buildings. Haul distances must allow discharge of concrete within 1 1/2 hours, but limit may be waived under certain circumstances.	No central mixing plant needed, only a batching plant, since concrete is completely mixed in truck mixer. Discharge is same as for truck agitator.	Timing of deliveries should suit job organization. Concrete crew and equipment must be ready onsite to handle concrete. Control of concrete quality is not as good as with central mixing.
Wheelbarrows and buggies	For short flat hauls on all types of onsite concrete construction, especially where accessibility to work area is restricted.	Very versatile and therefore ideal inside and on jobsites where placing conditions are constantly changing.	Slow and labor intensive.

Table 12, Methods and Equipment for Transporting and Handling Concrete (Chapter 6)

6.3.6 Sampling and Testing

Compliance with the requirements indicated in this Section shall be determined in accordance with the following standard methods of AASHTO or ASTM:

- Sampling Fresh Concrete, AASHTO T 141 (ASTM C 172)
- Weight Per Cubic Foot, Yield and Air Content (Gravimetric) of Concrete, AASHTO T 121 (ASTM C 138).
- Sieve Analysis of Fine and Coarse AGGRGATE, AASHTO T 27.
- Slump of Portland Cement Concrete, AASHTO T 119 (ASTM C 143).
- Air Content of FRESHLY Mixed Concrete by the Pressure Method, AASHTO T 152 (ASTM C 231).
- Specific Gravity and Absorption of Fine Aggregate, AASHTO T 84 (ASTM C 128)
- Specific Gravity and Absorption of coarse Aggregate, AASHTO T 85 (ASTM C 127).
- Unit Weight of Structural Lightweight Concrete, ASTM C 567.
- Making and Curing Concrete TEST Specimens in the Laboratory, AASHTO T 126 (ASTM C 192).
- Making and Curing Concrete Test Specimens in the Field, AASHTO T 23 (ASTM C 31).
- Compressive Strength of Cylindrical Concrete Specimens, AASHTO T 22 (ASTM C 39).

6.3.6.1 Slump Test

As mentioned earlier a test that will indicate changes in consistency is the slump test. The apparatus consists of a metal cone, 4-inch diameter at the top, 8-inch diameter at the bottom and 12-inch high, and a metal tamping rod 2 feet long and 5/8-inch diameter, bullet pointed at the tamping end. The cone should be first inspected to make sure that the internal surface is clean, dry and free from set cement. It is then placed on a smooth, flat, impervious surface such as a steel plate, the operator holding it firmly in place by standing on the foot pieces. The cone is then filled with freshly mixed concrete to about one-fourth of its height and tamped with 25 strokes of the rod. The filling is complete in successive layers similar to the first and the top struck off level with a trowel. Immediately afterwards, the cone is removed by lifting vertically, the molded concrete allowed to subside, and the height of the specimen measured after coming to rest. The consistency is then recorded in terms of inches of subsidence of the specimen during the test, which is known as the slump. The idea in controlling the slump is to control directly the consistency and workability necessary for concrete placement, and indirectly the water-cement ratio; the principle being that repeated batches of the same mix having the same consistency will have the same water content and consequently the same water-cement ratio provided factors like batch weights or volumes, aggregate grading, and temperature of materials are practically uniform. Fortunately, variations in water content have a much more pronounced effect on slump than variations in the factors mentioned above. Hence on jobs where grading and hatching are properly controlled, slump variations will reflect variations in water content and water-cement ratio.

6.3.6.2 Compressive Strength

Concrete compressive strength requirement consists of a minimum strength at the age of twenty-eight (28) days and the minimum strength which must be attained before various loads or stresses are applied to the concrete. The various strengths required are specified in Table 401-1. The compressive strength of concrete will be determined from test cylinders, which have been fabricated from concrete sampled and tested in accordance with AASHTO T 23, AASHTO T 22 ASTM C - 39. A set of six (6) cylinders shall be taken from each fifty (50) cubic meters of each class of concrete or fraction thereof placed each day, three (3) of the six (6) cylinders to be tested after even (7) days and three (3) after twenty-eight (28) days.

- a) The minimum average 28 days test result of all samples tested at any time shall be the specified twenty-eight (28) days strength.
- b) No individual samples tested after 28 days shall show a test result lower than eighty-five (85) percent of the required twenty-eight (28) days.
- c) Specimens shall not be tested if any individual diameter of a cylinder differs from any other diameter of the same cylinder by more than 2 %.

Concrete represented by any single test cylinders that fails to comply with the requirement under(b) above will be rejected unless the contractor at his expense, provides evidence that the strength and quality of the concrete placed in the work are acceptable. If such evidence consists of tests made on cores taken from the work, the cores shall be obtained and tested in accordance with the specifications of AASHTO T -24.

Test results of the cores shall meet the following requirements: -

- a) Average test result of the cores shall be less than the minimum required twenty-eight (28) days strength
- b) No individual core shall show a strength less than Ninety-five (95) percent of the required twenty-eight (28) days strength.

Should the above test results fail to comply with the requirements concrete of that particular pour shall be rejected and removed as directed by the Engineer. Furthermore, contractor shall redesign the concrete mix for approval of the Engineer.

In case, seven (7) days strength shows less than seventy (70) percent of the twenty-eight (28) days strength (in case of type-I cement), Engineer may stop further work on that particular portion of concrete, unless twenty-eight (28) days strength gives satisfactory results.

Trial Batches for mix Productions

The placing of concrete shall not begin until trial batches of the mix design to be used have been produced by the Contractor and tested and approved by the Engineer. The trial mix proportions shall be such that the average strength of five (5) consecutive test cylinders shall be 20% higher than the specified twenty-eight (28) days strength and no individual test cylinder shall be below the specified strength.

When concrete compressive strength is specified as a prerequisite to applying loads or stresses to a concrete structure or member, test cylinders will be cured under conditions similar to those at the casting site. The compressive strength of concrete determined for such purposes will be evaluated on the basis of individual tests.

6.3.6.2.1 Minimum Cube Strength Requirement & Strength corresponding to Cylinder

Unless otherwise specified concrete mixes shall conform to the strength requirements given in the following table: -

Nominal Mix	Minimum cube strength required (in psi)				General use
	Laboratory Tests		Work Tests		
	7 days	28 days	7 days	28 days	
1:1:2	4000	6000	3000	4500	In paving.
1:1½:3	3350	5000	2500	3750	For reinforced concrete other than in paving
1:2:4	2700	4000	2000	3000	
1:3:6	-	2500	-	2000	For mass concrete
1:4:8	-	2000	-	1500	For Lean concrete

Table 13, Minimum Cube Strength Requirements (Chapter 6)

28 days 6 inches x 12 inches (15cm x 30 cm) cylinder strength corresponding to 28 days cube strength in the Table are given hereunder: -

28 days cube strength (Psi)	6" x 12" cylinder strength (Psi)
4500	4000
3750	3000
3000	2200
2000	1500

Table 14, 28 Days Cube Strength (Chapter 6)

Lower grade concrete with greater proportions of sand and coarse aggregates could be used as specified. The cube strength for these mixes shall be determined in field for reference.

6.3.7 Evaluation of Concrete Strength

6.3.7.1 Tests

A strength test shall consist of the average strength of two compressive strength test cylinders fabricated from material taken from a single randomly selected batch of concrete, except that, if any cylinder should show evidence of improper sampling, molding, or testing, said cylinder shall be discarded and the strength test shall consist of the strength of the remaining cylinder.

6.3.7.2 For Controlling Construction Operation

For determining adequacy of cure and protection, and for determining when loads or stresses can be applied to concrete structures, test cylinders shall be cured at the structure site under condition that are not more favorable than the most unfavorable conditions for the portions of the structure which they represent as described in Article 9.44 of AASHTO T 23. Sufficient test cylinders shall be made and tested at the appropriate ages to determine when operations such as release of false work, application of prestressing forces or placing the structure in service can occur.

6.3.7.3 For Acceptance of Concrete

For determining compliance of concrete with a specified 28-day strength, test cylinders shall be cured under controlled conditions as described in Article 9.3 of AASHTO T 23 and tested at the age of 28 days. Samples or acceptance tests for each class of concrete shall be taken not less than once a day nor less than once for each 150 cubic yards of concrete or once for each major placement. Any concrete represented by a test which indicates a strength which is less than the specified 28-day compressive strength by more than 500 psi will be rejected and shall be removed and replaced with acceptable concrete

6.3.7.4 For Control of Mix Design

Whenever the average of three consecutive tests, which were made to determine acceptability of concrete, falls to less than 150 psi above the specified strength or any single test falls more than 200 psi below the specified strength, the Contractor shall, at own expense, make corrective changes in the materials, mix proportions or in the concrete manufacturing procedures before placing additional concrete of that class. Such changes must be approved by the Engineer prior to use.

6.3.7.4 Steam Radiant Heat Cured Concrete

When a precast concrete member is steam or radiant heat-cured, the compressive strength test cylinders made for any of the above purposes shall be cured under conditions similar to the member. Such concrete will be considered to be acceptable whenever a test indicates that the concrete has reached the specified 28-day compressive strength provided such strength is reached not more than 28 days after the member is cast.

6.4 Protection of Concrete from Environmental Conditions

6.4.1 General

Precautions shall be taken as needed to protect concrete from damage due to weather or other environmental conditions during placing and curing operations. Concrete that has been frozen or otherwise damaged by weather conditions shall be either repaired to an acceptable condition or removed and replaced. The temperature of the concrete mixture immediately before placement shall be between 50 F and 90 F, except as otherwise provided herein.

6.4.2 Rain Protection

Under conditions of rain, the placing of concrete shall not commence or shall be stopped unless adequate protection is provided to prevent damage to the surface mortar or damaging flow or wash of the concrete surface.

6.4.3 Hot and Weather Protection

When the ambient temperature is above 90 F, the forms reinforcing steel, steel beam flanges, and other surfaces which will come in contact with the mix shall be cooled to below 90 F by means of a water spray or other approved methods. The temperature of the concrete at time of placement shall be maintained within the specified temperature range by any combination of the following:

- Shading the materials storage areas or the production equipment.
- Cooling the aggregates by sprinkling with water which conforms to the requirements of Heading 30-3.2 of these specifications.
- Cooling the aggregates or water by refrigeration or replacing a portion or all of the mix water with ice that is flaked or crushed to the extent that the ice will completely melt during mixing of
- the concrete.
- Liquid nitrogen injection.

6.4.4 Cold Weather Protection

6.4.4.1 Protection during Cure

When there is a probability of air temperatures below 35 F during the cure period, the Contractor shall submit for approval by the Engineer prior to concrete placement, a cold weather concreting and curing plan detailing the methods and equipment which will be used to assure that the required concrete temperatures are maintained. The concrete shall be maintained at a temperature of not less than 45 F for the first six days after placement except that when pozzolan cement or fly ash cement is used, this period shall be as follows:

Percentage of Cement Replaced, by Weight, With Pozzolans	Required Period of Controlled Temperature
10%	8 Days
11-15 %	9 Days
16-20 %	10 Days

Table 15, Requirement for an extended period of controlled temperature (Chapter 6)

The above requirement for an extended period of controlled temperature may be waived if a compressive strength of 65% of the specified 28-day design strength is achieved in 6 days. If external heating is employed, the heat shall be applied and withdrawn gradually and uniformly so that no part of the concrete surface is heated to more than 90 F or caused to change temperature by more than 20 F in 8 hours. When requested by the Engineer, the Contractor shall provide and install two maximum-minimum type thermometers at each structure site. Such thermometers shall be installed as directed by the Engineer so as to monitor the temperature of the concrete and the surrounding air during the cure period.

6.4.4.2 Mixing and Placing

When the air temperature is below 35 F, the temperature of the concrete at the time of placement in sections less than 12 inches thick shall be not less than 60 F. Regardless of air temperature, aggregates shall be free of ice, frost and frozen lumps when batched and concrete shall not be placed against any material whose temperature is 32 F or less.

6.4.4.3 Heating of Mix

When necessary in order to produce concrete of the specified temperature, either the mix water or the aggregates, or both, shall be heated prior to batching. Heating shall be done in a manner which is not detrimental to the mix and does not prevent the entrainment of the required amount of air. The methods used shall heat the materials uniformly. Aggregates shall not be heated directly by gas or oil flame or on sheet metal over fire. Neither aggregates nor water shall be heated to over 150 F. If either are heated to over 100 F, they shall be mixed together prior to the addition of the cement so that the cement does not come into contact with materials which are in excess of 100 F.

6.4.5 Special Requirements for Bridge Decks

During periods of low humidity, wind or high temperatures and prior to the application of curing materials, concrete being placed and finished for bridge decks shall be protected from damage due to rapid evaporation. Such protection shall be adequate to prevent premature crusting of the surface or an increase in drying cracking. Such protection shall be provided by raising the humidity of the surrounding air with fog sprayers operated upwind of the deck, the use of windbreaks or sun-shades, additionally reducing of the temperature of the concrete, scheduling placement during the cooler times of days or nights, or any combination thereof. For bridge decks that are located over or adjacent to salt water or when specified, the maximum temperature of the concrete at time of placement shall be 80 F.

6.4.6 Concrete Exposed to Salts Water

Unless otherwise specifically provided, concrete for structures exposed to salt or brackish water or concrete placed under water shall be class A2. Such concrete shall be mixed for a period of not less than 2 minutes and the water content of the mixture shall be carefully controlled and regulated so as to produce concrete of maximum impermeability. The concrete shall be thoroughly consolidated as necessary to produce maximum density and a complete lack of rock pockets. Unless otherwise indicated on the plans, the clear distance from the face of the concrete to the reinforcing steel shall be not less than 4 inches. No construction joints shall be formed between levels of extreme low water and extreme high water or the upper limit of wave action as determined by the Engineer. Between these levels the forms shall not be

removed, or other means provided, to prevent salt water from coming in direct contact with the concrete for a period of not less than 30 days after placement. Except for the repair of any rock pockets and the plugging of form tie holes, the original surface as the concrete comes from the forms shall be left undisturbed. Special handling shall be provided for precast members to avoid even slight deformation cracks.

6.4.7 Concrete Exposed to Sulfate Soils or Water

When the special provisions identify the area as containing sulfate soils or water, the concrete that will be in contact with such soil or water shall be mixed, placed and protected from contact with soil or water as required for concrete exposed to salt water except that the protection period shall be not less than 72 hours.

6.5 Form Work

6.5.1 Material Requirements

All material shall comply with the requirements of ACI 347-R 2014 'Guide to formwork for concrete'. Materials and components used for formwork shall be examined for damage or excessive deterioration before use and shall be used only if found suitable after necessary repairs. In case of timber form work, the inspection shall not only cover physical damages but also signs of attacks by decay, rot or insect attack or the development of splits. Forms shall, be constructed with metal or timber. The metal used for forms shall be of such thickness that the forms remain true to shape. All bolts should be countersunk. The use of approved internal steel ties or steel or plastic spacers shall be permitted. Structural steel tubes used as support for forms shall have a minimum wall thickness of 4 mm. Other materials conforming to the requirements of ACI 347-R 2014 may also be used if approved by the Engineer. Following materials should be used for formwork: -

- Timber
- Plywood
- Steel
- Aluminum
- Plastics
- Fabric
- Fiber Glass

Materials	Principal uses
Sawn lumber	Form framing, sheathing, and shoring
Engineered wood*	Form framing and shoring
Plywood	Form sheathing and panels
Steel	Panel framing and bracing Heavy forms and falsework
	Column and joist forms
	Stay-in-place deck forms
	Shoring
	Steel joists used as horizontal shoring Expanded metal bulkheads, single-sided forms
Aluminum	Form panels and form framing members Horizontal and vertical shoring and bracing
Reconstituted wood panel products	Form liners and sheathing
Insulation materials	Stay-in-place form liners or sheathing
Wood fiber or glass fiber Other commercial products	Cold-weather protection for fresh concrete
Fiber or laminated paper pressed tubes or forms	Column and beam forms Void forms for slabs, beams, girders and precast piles
Corrugated cardboard	Internal and under-slab void forms Void forms in beams and girders (normally used with internal "egg-crate" stiffeners)

Concrete	Stay-in-place forms Molds for precast units
Glass fiber-reinforced plastic	Ready-made column forms Domes and pans for concrete joist construction Custom-made forms for special architectural effects Form ties
Cellular plastics	Form lining and insulation Stay-in-place wall forms
Other plastics, including ABS, polypropylene, polyethylene, polyvinyl chloride, polyurethane	Form liners, both rigid and flexible, for decorative concrete Chamfer and rustication formers
Rubber and rubberized or architectural fabrics	Form lining and void forms Inflatable forms for dome and culvert construction
Form ties, anchors, and hangers	Hold formwork secure against loads and pressures from concrete and construction activities
Side form spacers	Maintain correct distance between reinforcement and form to provide specified concrete cover for steel
Plaster	Waste molds for architectural concrete
Release agents and protective form coatings	Help preserve form facing and facilitate release

Table 16, Form Materials with Data Sources for Design and Specifications (Chapter 6)

6.5.1.1 Timber

Timber shall be the most common material used for bracing the members called as traditional formwork. Timber used for formwork should have following requirements: -

- It should be well seasoned
- Should be light in weight
- Easily workable with nails without splitting
- It should free from loose knots

6.5.1.2 Lumber

1. Size Classification

- Boards: Lumber that shall be less than 2 in. (50.8 mm) thick and 2 in. (50.8 mm) or more wide. Boards' thicknesses shall refer to the smallest cross-section dimension of lumber and the term width refers to the largest dimension. Boards less than 6 in. (152.4 mm) wide shall be classified as strips. Boards shall be used for sheathing, roofing, siding, and paneling.

- Dimension lumber: Lumber with a nominal thickness of 2–5 in. (50.8–127 mm) and a nominal width of 2 in. (50.8 mm) or more. Dimension lumber shall range in size from 2 x 2 in. (50.8 x 50.8 mm) to 4 -16 in. (101.6 x 406.4 mm). Dimension lumber shall be used for general construction where appearance is not a factor, such as studding, blocking, and bracing.

2. Mechanical Properties of Lumber

a. Bending Stresses

The lumber shall be stressed internally to resist the external loads. Bending in a member shall causes tension forces in the extreme fibers along the face farthest from the load and causes compression in the fiber along the side closest to the applied load. The maximum stress induced in the fibers, which occurs at the edges, shall be referred as the “extreme fiber stress in bending.” This stress shall be highly dependent on the parallel-to-grain strength of the wood in both tension and compression. The allowable bending stresses shall be based on a clear specimen having no defects. Allowable bending stresses shall then factored to account for defects.

b. Modulus of Elasticity (MOE)

(MOE) is a relationship between the amount of deflection in the member and the value of load applied that causes the deflection. The amount of deflection should depend on the size of the member, the span between the supports, the load, and the particular member specie of wood. The parallel-to-grain MOE (i.e., the stiffness when wood is pushed or pulled parallel to the wood grain) should be about 30 times greater than the perpendicular-to-grain MOE.

c. Tensile and Compressive Strengths

Tensile strength shall measure of the ability of wood to resist pulling forces. On the other hand, compressive strength shall be the measure of the ability of wood to resist pushing forces. For clear wood (wood without defects), the tensile and compressive strengths for parallel-to-grain loads should approximately 10 times greater than for loads applied perpendicular to the wood grain.

6.5.1.3 Plywood

Plywood shall be used as sheathing that contact concrete for job-built forms and prefabricated form panels. Most plywood panels shall be made of softwood. Many species of trees shall be used to make plywood, such as Douglas fir and Southern pine. The grain of each ply shall be laid at a right angle to the adjacent pieces that should give extra strength and reduces shrinkage and swelling. Size of Plywood sheets should be 4 x 8 ft (1.22 x 2.44 m). Plywood called “1/2 in. (12.7 mm) plywood” shall be 1/2 in. (12.7 mm) thick. In contrast to the situation with lumber, actual and nominal thickness for plywood shall be same; 1 in. (25.4 mm) plywood shall be 1 full inch (25.4 mm) thick.

Special type of plywood called exterior plywood should be used for formwork. The plywood boards shall be available in thicknesses from 7mm to 32mm. In general, plywood of size 1220 x 2440 and 18mm thick boards should be sufficient for most of the works.

1. Ply form

Plyform shall be a plywood product specially made for concrete formwork. Plyforms shall be available in class I and class II, where class I shall be stronger than class II. Other plyform that

shall commonly use for formwork includes B-B plyform, high-density overlaid (HDO), and structural 1 plyform.

6.5.1.4 Steel

This shall consist of panels fabricated out of thin steel plates stiffened along the edges by small steel angles. The panel units should be held together through the use of suitable clamps or bolts and nuts. The panels should be fabricated in large number in any desired modular shape or size. Steel forms should be largely used in large projects or in situation where large number of reuses of the shuttering shall be possible.

Steel sections shall be used in the fabrication of different formwork components, namely: -

- steel panel forms,
- horizontal and vertical shores,
- steel pan and dome components used for joist and waffle slabs,
- steel pipes for formwork bracing.

Other heavy forms and formwork shall also made of steel, such as bridge formwork.

6.5.1.5 Aluminum

Aluminum shall be used for many formwork applications such as lightweight panels, joists, horizontal and vertical shoring, and aluminum trusses for flying forms. Aluminium Formwork System shall provide aluminium Formwork for RCC load bearing or RCC framed multi-storied buildings and shall enable the walls and slabs to be poured in the same operation. The aluminum formworks should be recycled after smelting. Aluminum formworks are light in weight and highly precise in assembly. The installation process is easier and the installation time should be reduced by 30% compared with the wooden formworks. An area of 2,000 m² aluminum formworks should be completed in about 35 hours.

6.5.1.6 Fiber Glass

Fiber glass is less expensive than steel and aluminum forms/shuttering. It shall provide smooth concrete finish. It should have sealed edges to improve water resistance. Large areas or sections should be made without joints or seams. Fiberglass form work should be used when repeated usage is possible.

6.5.2 Formwork Design

Forms work shall conform to the various shaped lines, grades and dimensions of the concrete as shown on the drawings or as established by the Engineer-in-charge. Their material and design shall be subject to the approval by the Engineer-in-charge before their construction is started. However, such approval shall not relieve the contractor of the responsibility for the adequacy of the forms nor from the necessity for remedying any defects which may develop or become apparent with use. The Engineer-in-charge may at any time condemn any sections of forms found deficient in any respect, and the contractor shall promptly remove the condemned forms from the work and replace them at his own expense.

6.5.2.1 Choose a Formwork System

Choosing formwork system activity includes the process of selecting formwork systems for different structural elements. It also includes the process of selecting accessories, bracing, and a release agent for the selected formwork system. There are several forming systems used in the construction of reinforced concrete structures. For example, formwork systems for concrete slabs can be classified as hand-set or conventional systems and crane-set systems. Conventional systems are still the most common and popular formwork systems. Their popularity stems from their ability to form different shapes and elements. However, conventional formwork usually results in high labor and material cost. Nonconventional or crane-set systems have gained increasing popularity because of low labor costs and their ability to achieve faster construction cycle.

Before selecting any system of form work contractor will get the written permission from Engineer in charge and Engineer in charge will propose the best suitable form work system keeping the requirement of project in mind. It's necessary that Contractor will follow the technical specifications of the specific project and conditions of contract.

6.5.2.1.1 Horizontal form work Conventional

The traditional slab formwork technique shall consist of supports out of lumber or young tree trunks, that support rows of stringers assembled roughly 3 to 6 feet or 1 to 2 meters apart, depending on thickness of slab. Between these stringers, joists are positioned roughly 12 inches, 30 centimeters apart upon which boards or plywood are placed. The stringers and joists shall usually 4 by 4 inch or 4 by 6-inch lumber. The most common imperial plywood thickness shall be $\frac{3}{4}$ inch and the most common metric thickness shall be 18 mm.

6.5.2.1.2 Horizontal form work- Flying / Table form work

A table form/flying form is a large pre-assembled formwork and false work unit, often forming a complete bay of suspended floor slab. It offers mobility and quick installation for construction projects with regular plan layouts or long repetitive structures, so is highly suitable for flat slab, and beam and slab layouts. Table form work consist of decks made of plywood and slab is lifted with the help of crane. slab formwork "tables" that are reused on multiple stories of a building without being dismantled so that's why the use of these systems can greatly reduce the time and manual labor involved in setting and striking the formwork. This type of formwork reduces the labor cost considerably as compared to conventional formwork.

6.5.3 Formwork Construction

- Forms work to confine the concrete and shape it to the required lines shall be used wherever necessary. They shall be made of metal, of metal lined timber, or of smooth planed boards in good condition.
- A smooth finished surface of the concrete shall be required. The forms shall be true in every respect to the required shape and size, and shall be of sufficient strength and rigidity to maintain their position and shape under loads and operations incident to placing and vibrating the concrete.
- All forms when erected shall be tight. Adequate and suitable means for removing the forms without injury to the surface of the finished concrete shall be provided.
- Chamfer strips shall be placed in the form so as to produce leveled edges on permanently exposed concrete surfaces if indicated on the drawings or instructed by the Engineer-in charge.

- All forms shall be properly secured in position so as to prevent floating, or other movements, during the placing of concrete. Form supports shall be carried to firm foundation so that no settlement of the forms is possible during construction.
- Unless otherwise specified sliding forms shall be used for enclosing vertical structures which maintain a constant section to give a lift of concrete from 2 to 4 feet. In very tall structures they shall be made to move continuously during concreting operations.

6.5.4 Treatment of Formwork Construction

Unless otherwise specified the faces of this formwork which come into contact with the concrete shall be treated with parting agents, such as, mineral oils, vegetable oils and soaps, before reinforcement is placed, in order to prevent concrete from adhering to formwork and to reduce the risk of damage when the formwork is struck.

6.5.4.1 Form Coatings and release agents

1. Coatings

Form coatings or sealers shall be usually applied in liquid form to contact surfaces either during manufacture or in the field to serve one or more of the following purposes: -

- Alter the texture of the contact surface;
- Improve the durability of the contact surface;
- Facilitate release from concrete during stripping; or
- Seal the contact surface from intrusion of moisture.

2. Release agents

Form release agents should be applied to the form contact surfaces to prevent bond and thus facilitate stripping. They should be applied permanently to form materials during manufacture or shall be applied to the form before each use. When applying in the field, be careful to avoid coating adjacent construction joint surfaces or reinforcing steel.

3. Manufacturers' Recommendations

Manufacturers' recommendations should be followed in the use of coatings, sealers, and release agents, but independent investigation of their performance shall be recommended before use. When concrete surface color is critical, effects of the coating, sealing, and release agents should be evaluated. Where surface treatments such as paint, tile adhesive, sealers, or other coatings are to be applied to formed concrete surfaces, be sure that adhesion of such surface treatments will not be impaired or prevented by use of the coating, sealers, or release agent. Also, consider bonding requirements of subsequent concrete placements.

6.5.5 Preparation for Concrete Placing

1. No concrete shall be placed till all formwork, reinforcement, installation of parts to be embedded, bracing of forms, and preparation of surfaces involved in the placing have been approved by the Engineer-in-charge. No concrete shall be placed in water, except with the written permission of the Engineer-in-charge, and the method of depositing concrete shall be subject to his approval. Concrete shall not be placed in

running water and shall not be subjected to the action of running water until after the concrete has been cured for 28 days. All surfaces of forms and embedded materials that have become encrusted with dried mortar or grout from concrete previously placed shall be cleaned of all such mortar or grout before the surrounding or adjacent concrete is placed.

2. Immediately before placing concrete, all surface upon or against which it is to be placed shall be free from standing water, mud, debris or loose material. The surfaces of absorptive materials against or upon which concrete is to be placed shall be moistened thoroughly so that moisture is not drawn from the freshly placed concrete.
3. Where surface to be covered by fresh concrete are absorptive and where it will facilitate the placing and vibrating of concrete in paving and base slabs (which is to be determined by the Engineer-in-charge), the contractor shall place a "blinding course" consisting of a 2-inch layer of concrete. The "blinding course" shall be spread uniformly over the foundation to be protected and allowed to set for 24 hours before fresh concrete is placed.
4. Concrete surface upon or against which concrete is to be placed and to which new concrete is to adhere, and have become so rigid that the new concrete cannot be incorporated integrally with them are defined below as "construction joints". The surfaces of construction joints shall be clean and damp when covered with fresh concrete or mortar. These surfaces shall be cleaned by wet sand-blasting or other approved methods and then washed thoroughly with high pressure air water jets or other approved means immediately before fresh concrete is placed. Cleaning shall consist of the removal of all laitance, loose or defective concrete, coatings or foreign material. All pools of water shall be removed from the surface construction joints before new concrete is placed.
5. The surface of all contraction joints or expansion joints as shown on the drawings shall be thoroughly cleaned of accretions of concrete or other foreign material by scraping, chipping or by other means satisfactory to the Engineer-in-Charge.

6.5.5.1 Placing of Concrete

1. Concrete shall be placed only in presence of the Engineer-in-charge.
2. Any concrete which has become so stiff that proper placing cannot be assured shall be wasted and no payment shall be made to the contractor for such wasted concrete, including contained cement. Concrete shall be deposited direct in all cases as near as practicable to its final position and shall not flow in a manner to permit or cause segregation.
3. Concrete buckets, where used, shall be capable of promptly discharging the low-slump concrete mixes specified and the dumping mechanism shall be designed to permit the discharge or as little as four cubic feet portion of the load in one place.
4. Each layer of concrete shall be consolidated to the maximum practicable density so that it is free from pockets of aggregate, and close, snugly against all surfaces, of forms and embedded materials.
5. In consolidating each layer of concrete, the vibrating head of the vibrator shall be secured to form or allowed to penetrate and re-vibrate the concrete in the upper portion of the underlying layer. All concrete shall be consolidated with electric or pneumatic power-driven vibrators having a frequency of not less than 5000 cycles per minute. Additional layers of concrete shall be placed after the layers previously placed have been worked thoroughly so that no air bubble comes to the surface. The operation shall be carried out by a person trained in the job.

6. Special care shall be taken in placing concrete when it has to be dropped from a height, especially when reinforcement is in the way, and every effort shall be made to reduce this drop to the minimum. In any case the drop shall not be more than 5 feet.
7. Unless otherwise specified, no peripheral slopes shall be allowed in the bed when it becomes necessary for any reason to terminate placing operations. Such termination shall be against forms stepped as directed by the Engineer-in-charge.
8. Ducts, recesses, rebates and holes shall be molded in the concrete during placing at their proper position as shown on the drawing or as directed by the Engineer-in-charge

6.5.6 Removal of Forms

In all cases the contractor shall satisfy himself that reinforced and prestressed concrete has thoroughly set before removing formwork and shuttering or supports and shall obtain the permission of the Engineer-charge before removing formwork, shuttering and supports. The following minimum times shall elapse after depositing reinforced concrete in forms before the later may be removed.

Work	Cold Weather	Hot Weather
Columns, sides to beams	3 days	2 days
Props to slabs and beams	10 days	7 days
Props to beams and slabs in composite action	14 days	10 days

Table 17, Removal of Forms (Chapter 6)

6.5.7 Measurement and Payment

Form work shall be measured in the unit of sq. ft and payment to the contractor will be made on rental basis as per the rate analysis of this item. Engineer in Charge will be responsible for the evaluation of work to be paid to contractor.

6.6 Handling and Placing Concrete

6.6.1 General

Concrete shall be handled, placed, and consolidated by methods that will not cause segregation of the mix and will result in a dense homogeneous concrete which is free of voids and rock pockets. The methods used shall not cause displacement of reinforcing steel or other materials to be embedded in the concrete. Concrete shall be placed and consolidated prior to initial set and in no case more than 1 ½ hours after cement was added to the mix. Re tempering the concrete by adding water to the mix shall not be done.

Concrete shall not be placed until the forms, all materials to be embedded and, for spread footings the adequacy of the foundation material have been inspected and approved by the Engineer. All mortar from previous placements, debris, and foreign material shall be removed from the forms and steel prior to commencing placement. The forms and subgrade shall be thoroughly moistened with water immediately before concrete is placed against them. Temporary form spreader devices may be left in place until concrete placement precludes their need, after which they shall be removed.

Placement of concrete for each section of the structure shall be done continuously without interruption between planned construction or expansion joints. The delivery rate, placing sequence and methods shall be such that fresh concrete is always placed and consolidated against previously placed concrete before initial set has occurred in the previously placed concrete.

During and after placement of concrete, care shall be taken not to injure the concrete or break the bond with reinforcing steel. Workmen shall not walk in fresh concrete. Platforms for workmen and equipment shall not be supported directly on any reinforcing steel. Once the concrete is set, forces shall not be applied to the forms or to reinforcing bars, which project from the concrete, until the concrete is of sufficient strength to resist damage.

6.6.2 Sequence of Placing

Whenever a concrete placement plan or schedule is specified or approved, the sequence of placement shall conform to the plan. Unless otherwise specifically permitted by such a placement plan, the requirements of the following paragraphs shall apply.

6.6.2.1 Vertical Members

Concrete for columns and retaining walls, and other similar vertical members shall be placed and allowed to set and settle for a period of time before concrete for integral horizontal members, such as caps, slabs, or footings is placed. Such period shall be adequate to allow completion of settlement due to loss of bleed water and shall be not less than 12 hours for vertical members over 15 feet in height and not less than 30 minutes for members over 5 feet but not over 15 feet in height. When friction collars or falsework brackets are mounted on such vertical members and unless otherwise approved, the vertical member shall have been in place at least 7 days and shall have attained its specified strength before loads from horizontal members are applied.

6.6.2.2 Superstructure

1. Unless otherwise permitted, no concrete shall be placed in the superstructure until substructure forms have been stripped sufficiently to determine the character of the supporting substructure concrete.
2. Concrete for T-beam or deck girder spans whose depth is less than 4 feet may be placed in one continuous operation or may be placed in two separate operations; first, to the top of the girder stems, and second, to completion. For T-beam or deck girder

spans whose depth is 4 feet or more and, unless the false work is nonyielding, such concrete shall be placed in two operations and at least 5 days shall elapse after placement of stems before the top deck slab is placed.

3. Concrete for box girders may be placed in two or three separate operations consisting of bottom slab, girder stems and top slab. In either case the bottom slab shall be placed first and, unless otherwise permitted by the Engineer, the top slab shall not be placed until the girder stems have been in place for at least 5 days.

6.6.2.3 Arches

Concrete for box girders may be placed in two or three separate operations consisting of bottom slab, girder stems and top slab. In either case the bottom slab shall be placed first and, unless otherwise permitted by the Engineer, the top slab shall not be placed until the girder stems have been in place for at least 5 days.

6.6.2.4 Present Elements

The sequence of placement for concrete in precast elements shall be such that sound well-consolidated concrete which is free of settlement or shrinkage cracks is produced throughout the member.

6.6.3 Placing Methods

6.6.3.1 General

1. Concrete shall be placed as nearly as possible in its final position and the use of vibrators for extensive shifting of the mass of fresh concrete will not be permitted.
2. Concrete shall be placed in horizontal layers of a thickness not exceeding the capacity of the vibrator to consolidate the concrete and merge it with the previous lift. In no case shall the depth of a lift exceed 2 feet. The rate of concrete placement shall not exceed that assumed for the design of the forms as corrected for the actual temperature of the concrete being placed.
3. When placing operations would involve dropping the concrete more than 5 feet, the concrete shall be dropped through a tube fitted with a hopper head, or through other approved devices, as necessary to prevent segregation of the mix and spattering of mortar on steel and forms above the elevation of the lift being placed. This requirement shall not apply to cast-in-place piling when concrete placement is completed before initial set occurs in the first-placed concrete.

6.6.3.2 Equipment

1. All equipment used to place concrete shall be of adequate capacity and designed and operated so as to prevent segregation of the mix or loss of mortar. Such equipment shall not cause vibrations that might damage the freshly placed concrete. No equipment shall have aluminum parts which come in contact with the concrete. Between uses, the mortar coating inside of placing equipment which sets or dries out shall be cleaned from the equipment before use is resumed.
2. Chutes shall be lined with smooth watertight material and, when steep slopes are involved, shall be equipped with baffles or reverses.
3. Concrete pumps shall be operated such that a continuous stream of concrete without air pockets is produced. When pumping is completed, the concrete remaining in the pipeline, if it is to be used, shall be ejected in such a manner that there will be no contamination of the concrete or separation of the ingredients.
4. Conveyor belt systems shall not exceed a total length of 550 lineal feet, measured from end to end of the total assembly. The belt assembly shall be so arranged that each

section discharges into a vertical hopper arrangement to the next section. To keep segregation to a minimum, scrapers shall be situated over the hopper of each section so as to remove mortar adhering to the belt and to deposit it into the hopper. The discharge end of the conveyor belt system shall be equipped with a hopper, and a chute or suitable deflectors to cause the concrete to drop vertically to the deposit area.

6.6.4 Consolidation

1. All concrete, except concrete placed under water and concrete otherwise exempt, shall be consolidated by mechanical vibration immediately after placement. The vibration shall be internal except that external form vibrators may be used for thin sections when the forms have been designed for external vibration.
2. Vibrators shall be of approved type and design and of a size appropriate for the work. They shall be capable of transmitting vibration to the concrete at frequencies of not less than 4,500 impulses per minute.
3. The Contractor shall provide a sufficient number of vibrators to properly compact each batch immediately after it is placed in the forms. The Contractor shall also have at least one spare vibrator immediately available in case of breakdown.
4. Vibrators shall be manipulated so as to thoroughly work the concrete around the reinforcement and imbedded fixtures and into the corners and angles of the forms. Vibration shall be applied at the point of deposit and in the area of freshly deposited concrete. The vibrators shall be inserted and withdrawn out of the concrete slowly. The vibration shall be of sufficient duration and intensity to thoroughly consolidate the concrete, but shall not be continued so as to cause segregation. Vibration shall not be continued at any one point to the extent that localized areas of grout are formed. Application of vibrators shall be at points uniformly spaced and not further apart than 1.5 times the radius over which the vibration is visibly effective.
5. Vibration shall not be applied directly to, or through the reinforcement to sections or layers of concrete which have hardened to the degree that the concrete ceases to be plastic under vibration. Vibrators shall not be used to transport concrete in the forms. When immersion-type vibrators are used to consolidate concrete around epoxy-coated reinforcement, the vibrators shall be equipped with rubber or other non-metallic coating.
6. Vibration shall be supplemented by such spading as is necessary to ensure smooth surfaces and dense concrete along form surfaces and in corners and locations impossible to reach with the vibrators. When approved by the Engineer, concrete for small noncritical elements may be consolidated by the use of suitable rods and spades.

6.6.5 Placing Concrete Underwater

6.6.5.1 General

- When the space to be filled with concrete contains water which cannot be removed in some practical way or when so specified or directed by the Engineer-in-charge the concrete shall be deposited under water according to the following stipulations.
- Only concrete used in cofferdams to seal out water may be placed under water unless otherwise specified or specifically approved by the Engineer. The minimum cement content of the mix shall be increased by 10% to compensate for loss due to wash.
- To prevent segregation, concrete placed under water shall be carefully placed in a compact mass, in its final position, by means of a tremie, concrete pump, or other approved method, and shall not be disturbed after being deposited. Still water shall be maintained at the point of deposit and the forms under water shall be watertight.

Cofferdams shall be vented during the placement and cure of concrete to equalize the hydrostatic pressure and thus prevent flow of water through the concrete.

- Concrete placed under water shall be placed continuously from start to finish. The surface of the concrete shall be kept as nearly horizontal as practicable. To ensure through bonding, each succeeding layer of seal shall be placed before the preceding layer has taken initial set. For large pours, more than one tremie or pump shall be used to ensure compliance with this requirement.

6.6.5.2 Equipment

- **Tremie:** The top section of the tremie shall be a hopper enough to hold one complete batch of the mix or the entire contents of the transporting bucket when it is used. The tremie pipe shall not be less than 8 inches in diameter and shall be large enough to allow a free flow of concrete so strong enough to withstand the external pressure of water in which it is suspended, even if a partial vacuum develops inside the pipe. Unless otherwise specified, flanged steel pipe of adequate strength to sustain the greatest length and weight shall be used. A separate lifting device shall be provided for each tremie pipe with its hopper at the upper end. Unless the lower end of the pipe is equipped with an approved automatic check valve, the upper end shall be plugged with a wadding of gunny sacking or other approved material, before delivering the concrete to the tremie pipe through the hopper. The hopper shall be forced to and out of the bottom end of the pipe by filling the pipe with concrete. The tremie shall be raised slowly to cause a uniform flow of the concrete, but it shall not be emptied so that water enters above the concrete in the pipe. From the time the placing of concrete starts till it finishes, the lower end of the tremie pipe shall be below the top surface of the plastic concrete. This shall cause the concrete to build up from below instead of flowing out over the surface, to avoid formation of laitance layers. If the charge in the tremie is lost while depositing, the tremie shall be raised above the concrete surface, and if not sealed by a check valve it shall be re-plugged at the top end, as at the beginning, before refilling for depositing concrete.
- **Bottom Dump Bucket:** The bottom dump bucket shall be of the type that cannot be opened till it has rested, with its load, on the surface upon which concrete is to be deposited. The bottom doors shall be so equipped as to be automatically unlatched by the release of tension on the supporting line or cable of the bucket and shall open downward and outward as the bucket is raised. The top of the bucket shall be fitted with double, overlapping canvas flaps, or other approved covers, to cover the contained concrete and to protect it from being washed as the bucket enters the water and descends to the bottom. The bucket shall preferably be so designed that the hinged bottom doors shall operate inside a steel skirt, which shall surround the bucket while the bottom doors are shut and shall extend below the bucket as the bottom doors open, and thus minimize turbulence and motion while the concrete is being deposited. The bucket shall be submerged slowly till it is completely under water. The normal dive speed after that shall not exceed 200 feet per minute. After the bucket has reached the surface on which concrete is to be deposited, it shall be raised slowly for the first six to eight feet to allow concrete to be deposited properly.
- **Sacks of Concrete:** When only a little quantity of concrete is to be deposited under water, it shall be placed in sacks; unless otherwise specified. The space to be concreted shall be filled with sacks of concrete carefully placed in header and stretcher formation, so that they become interlocked. Sacks used for this purpose shall be made of jute or other coarse material free from deleterious materials and duly approved by the Engineer-in-charge. They shall be filled about two-thirds with concrete and their openings securely tied.

6.6.5.3 Cleanup

Dewatering may proceed after test specimens cured under similar conditions indicate that the concrete has sufficient strength to resist the expected loads. All laitance or other unsatisfactory materials shall be removed from the exposed surface by scraping, chipping, or other means which will not injure the surface of the concrete before placing foundation concrete.

6.6.6 Placing Concrete under Sea Water

Unless otherwise specified, concreting under sea water shall be governed by the following stipulations:

1. The nominal mix employed shall under no condition be leaner than 1: 1: 2,
2. An air entrant agent or admixture duly approved by the Engineer-in-charge shall be added to give 3% - 6% entrained air in the concrete.
3. Sea water shall not be allowed to come in contact with the concrete till it has hardened for at least 4 days.
4. Reinforcement or other corrodible metal shall be placed not less than 3" from any plane or curved surface, and 4" adjacent surface at corners.
5. If specially required the face of concrete shall be protected from severe climatic conditions or severe abrasion by stone of suitable quality, dense verified shale bricks or creosoted timber as shown on the drawing or as directed by the Engineer-in-charge.

6.6.7 Placing Concrete in Saline Soil

Unless otherwise specified, concreting in saline soils shall be done keeping in view the following:

1. The nominal mix used shall be 1:1:2 or richer as actually specified by the Engineer-in-charge depending upon the degree of salinity.
2. Reinforcement or other corrodible metal shall not be placed closer than two inches from the surface of the concrete.

6.6.8 Compaction

As concrete is being placed it should be compacted thoroughly and uniformly by means of hand tools, vibrators, or finishing machines to secure a dense structure, a close bond with reinforcement, and smooth surface. Concrete should be worked well around the reinforcement and embedded fixtures and into the corners of the forms, but should not be worked more than necessary, since any disturbance of the concrete in place makes for segregation of materials, and the water and fine particles move towards the surface. This water may collect under the bars and the larger pieces of aggregate, thereby weakening the bond and opening channels for possible leakage through the concrete. Also, excessive working of concrete at formed surfaces brings undesirable fines and water to the surface brings undesirable fines and water to the surface. Sufficient equipment and operators should be provided in order that the entire mixer output can be handled without delay, otherwise the concrete may stiffen too much before it is thoroughly compacted and the surface is finished.

6.6.8.1 Hand Compaction

Ordinary hand methods of consolidating concrete consist of ramming, tamping; spading, and slicing with suitable tools. Tramping of the workmen while handling these tools also plays an important part in the compaction. Spading is done at or near vertical form faces in order to secure a smooth surface, but too much of spading will draw out an excess of cement paste

which will later craze, crack or scale, for compacting dry concrete the surface is rammed with a heavy flat-bottomed rammer until a thin film of mortar or paste appears at the surface, showing that the voids of the aggregate have been filled.

6.6.8.2 Compaction by Vibration

- Vibration as a means of consolidating concrete has many advantages over hand compaction methods. Modern high frequency vibrators make it possible to place, economically mixtures which cannot be placed by hand. For example, a concrete of still consistence $1\frac{1}{2}$ inches slump can be placed in forms containing closely spaced reinforcement by vibrators whereas a much wetter consistency is necessary, probably 5- or 6-inches slumps, for hand puddling. The action of vibration sets the particles of fresh concrete into motion, reducing friction between them, and affecting a temporary liquefaction of the concrete which enables it to settle easily into place.
- While vibration in itself does not affect the strength of concrete which is controlled by the water-cement ratio just in the case of hand compaction, it permits -the use of either less water or a leaner mix. Concrete of higher strength and better quality can, therefore, be made with a given cement factor because less mixing water can be used. Where only a given strength is required, it can be obtained with leaner mixes than possible with hand placing, thus making for economy. This shows that vibration makes for improvement in the quality of concrete as well as economy.
- In the case of vibration process, stiffer mixtures and also mixtures containing fewer fine materials can be used than are required to give the cohesive qualities necessary to prevent segregation in hand-placed mixtures. A larger proportion of coarse and a smaller proportion of fine aggregate can, therefore, be used. Since coarser gradings prevents less surface area to be coated with paste, less water or less paste can be used for a given consistency. Thus, improvement in quality and economy is affected by harsher as well as stiffer mixtures.
- The vibration method can be conveniently used for placing concrete under conditions where it is difficult to get good results by hand placing. Vibration makes it possible for the concrete to flow through small openings, and in and around closely spaced reinforcement.
- Shrinkage of a vibrated concrete owing to less moisture is somewhat less than concrete placed by hand because of the higher aggregate factor or lower water content. If the potential advantages of vibration are fully realized, volume changes due to changes in moisture content may be reduced by as much as one-half.
- When using vibrators for compacting, care must be taken in the construction of formwork. It must be stronger than that for hand-rammed work in order to withstand the hydrostatic pressure which develops when the concrete liquefies under vibration. For the same reason, the forms must be watertight.

6.6.8.2.1 Vibratory Equipment

Most of the high-frequency vibrators now available give at least 3,600 impulses per minute. Some of them produce twice this number or even more. They may be electrically driven, or operated from a petrol engine or air compressor. The vibrations are caused by eccentric weights attached to the shaft or the mortar or to the rotor of a vibrating element. Electric magnet pulsating equipment is also available.

Vibrators are of the following four general types: -

- i). Internal, "spud" or "needle" vibrators consist of a metal spud or rod, which is inserted into newly-placed concrete and which vibrates while being withdrawn.
- ii). Surface vibrators which are mounted on screeds or platforms and are chiefly used for consolidating road slabs, floors, etc.

- iii). External or "form" vibrators which are attached to formwork and external shuttering of walls, columns, etc. The forms transmit the vibrating action of the Concrete.
 - iv). Vibrating tables, which are used for making precast products.
- Any of these types should be applied systematically at short distances on the surface so that vibrated areas of concrete may overlap without omission of any part. Vibration should be continued till concrete has been thoroughly compacted and the voids have been filled, as indicated by the appearance of mortar or paste at the exposed surface or at lines of contact with the forms. Then vibration should be stopped; otherwise it would cause coarse aggregate to settle to the bottom and water or paste to rise to the top. Usually vibration should secure the desired results within 5 to 15 seconds at points 16 to 30 inches apart. It should not be done for longer periods at wider distances. Internal vibrators should be inserted to the full depth of the layer. They should be inserted and withdrawn slowly and operated continuously while being withdrawn so that no hole is left in the concrete. The entire depth of a new layer of concrete should be vibrated, and ordinarily the vibrator should penetrate the layer below for several inches to ensure through union of the layers. Concern has sometimes been expressed of the effects of re-vibration of a lower layer which may be partially hardened and in which the cement may be setting. Tests, however; indicate that re-vibration of partially set concrete actually improves its strengths. Apparently, the kneading action on the concrete further consolidates it.
 - Form vibrators are particularly effective on column and in the casting of precast units such as pipes, slabs, piles. The machine is fastened to a wale or gut and transmission of the vibration around the perimeter of the member is further assisted by means of an encircling chain where this is practicable. Form vibrators are also used on thin wall sections where reinforcement, ties and spreaders interfere too much with internal vibrators. The portable electric or air hammers are especially useful in such work as architectural concrete where the appearance of the finished work is particularly important, and also on sections that are too thin for internal vibrators. Vibrating tables are used for precast units which are made in gang molds fastened to the table. Tables are available in various sizes and are usually equipped with adjustable eccentrics so that both the speed and amplitude can be adjusted.
 - Personal preference and job conditions will affect the selection of the motive power for operating vibrators. On large jobs both electricity and compressed air are generally available. For smaller work compact, portable electric generating equipment is available which will not only furnish power for the vibrators but also for other small tools and for lighting. Petrol engines are also used to drive vibrators directly and can be very cheaply operated. On most jobs, power costs of operating vibrators are not important and personal preference and convenience will therefore generally govern the selection. High frequencies can be secured with all three kinds of power with properly designed equipment.

6.7 Cover Over Reinforcement

Unless otherwise specified the following minimum thickness of concrete cover, exclusive of plaster or other decorating finish, shall be provided in all cases:

- i. For each end of reinforcing bar, not less than 1 inch or twice the diameter of such bar.
- ii. For a longitudinal reinforcing bar in a column, not less than 1½ inches or the diameter of such bar. In the case of columns with a minimum dimension of 7 ½ inches or less where bars do not exceed ½ inch diameter, one-inch cover shall be used.
- iii. For longitudinal reinforcing bar in a beam not less than one inch or the diameter of such bar.
- iv. For tensile, compressive, shear or other reinforcement in a slab not less than ½ inch or the diameter of such reinforcement.
- v. For any other reinforcement not less than ½ inch or the diameter of such reinforcement.
- vi. In case of works in saline or corrosive conditions a minimum of 1 ½ inches cover over bars, stirrups or links

6.8 Construction Joints

6.8.1 General

Construction joints shall be made only where located on plans, or shown in the pouring schedule, unless otherwise approved. All planned reinforcing steel shall extend uninterrupted through joints. In the case of emergency, construction joints shall be placed as directed by the Engineer and, if directed, additional reinforcing steel dowels shall be placed across the joint. Such additional steel shall be furnished and placed at the Contractor's expense.

6.8.2 Bonding

1. Unless otherwise shown on the plans, horizontal joints may be made without keys and vertical joints shall be constructed with shear keys. Surfaces of fresh concrete at horizontal construction joints shall be rough floated sufficiently to thoroughly consolidate the surface and intentionally left in a roughened condition. Shear keys shall consist of formed depressions in the surface covering approximately one-third of the contact surface. The forms for keys shall be beveled so that removal will not damage the concrete.
2. All construction joints shall be cleaned of surface laitance, curing compound and other foreign materials before fresh concrete is placed against the surface of the joint. Abrasive blast or other approved methods shall be used to clean horizontal construction joints to the extent that clean aggregate is exposed. All construction joints shall be flushed with water and allowed to dry to a surface dry condition immediately prior to placing concrete.

6.8.3 Bonding and Doweling to Existing Structures

When new concrete is shown on the plans to be bonded to existing concrete structures, the existing concrete shall be cleaned and flushed as specified above. When the plans show reinforcing dowels grouted into holes drilled in the existing concrete at such construction joints, the holes shall be drilled by methods that will not shatter or damage the concrete adjacent to the holes. The diameters of the drilled holes shall be ¼ inch larger than the nominal diameter of the dowels unless shown otherwise on the plans. The grout shall be a neat cement paste of Portland cement and water. The water content shall be not more than 4 gallons per 94 pounds of cement. Re-tempering of grout will not be permitted. Immediately prior to placing the dowels, the holes shall be cleaned of dust and other deleterious materials, shall be

thoroughly saturated with water, have all free water removed and the holes shall be dried to a saturated surface dry condition. Sufficient grout shall be placed in the holes so that no voids remain after the dowels are inserted. Grout shall be cured for a period of at least 3 days or until dowels are encased in concrete.

When specified or approved by the Engineer epoxy may be used in lieu of Portland cement grout for the bonding of dowels in existing concrete. When used epoxy shall be mixed and placed in accordance with the manufacturer's recommendations.

6.8.4 Forms at Construction Joints

When forms at construction joints overlap previously placed concrete, they shall be retightened before depositing new concrete. The face edges of all joints that are exposed to view shall be neatly formed with straight bulk-heads or grade strips, or otherwise carefully finished true to- line and elevation.

6.9 Contraction & Expansion Joints

6.9.1 General

Expansion and contraction joints shall be constructed at the locations and in accordance with the details shown on the plans. Such joints include open joints, filled joints, joints sealed with sealants or water stops, joints reinforced with steel armor plates or shapes and joints with combinations of these features.

6.9.2 Material

6.9.2.1 Pre-molded Expansion Joint Fillers

Pre-molded fillers shall conform to one of the following specifications:

1. Specification for Preformed Expansion Joint Fillers for Concrete Paving and structural Construction, ASTM D-1751 Specification for Preformed Sponge Rubber and Cork Expansion Joint Fillers for Concrete Paving and Structural Construction, ASTM D-1752, Type II (cork) shall not be used when resiliency is required.
2. Specification for Preformed Expansion Joint Filler for Concrete, ASTM D- 994.

6.9.2.2 Polystyrene Board Fillers

Board fillers shall be expanded polystyrene with a minimum flexural strength of 35 pounds per square inch, as determined by ASTM C-203 and a compressive yield strength of between 16 and 40 pounds per square inch at 5% compression. When shown on the plans, or required to prevent damage during concrete placement, the surface of polystyrene board shall be faced with 1/8-inch-thick hardboard.

6.9.2.3 Contraction Joint Material

Material placed in contraction joints shall consist of asphalt saturated felt paper or other approved bond-breaking material.

6.9.2.4 Pourable Joint Sealants

Pourable sealants for placement along the top edges of contraction or filled expansion joints shall conform to the following: -

1. Hot-poured sealants shall conform to ASTM D-3406 except that when the sealant will be in contact with asphaltic material, it shall conform to ASTM D-3405.
2. Cold-poured sealant shall be silicone type. The sealant shall be a one-part, low modulus silicone rubber type with an ultimate elongation of 1,200%.
3. Polyethylene foam strip of dia 45mm or 25mm which one will be mentioned in BOQ, for use when shown on the plans, shall be of commercial quality with a continuous impervious glazed top surface, suitable for retaining the liquid sealant at the proper elevation in the joint while hardening.

6.9.2.5 Metal Armor

Expansion joint armor assemblies shall be fabricated from steel in conformance with the requirements of Chapter of Structure Steel. Assemblies shall be accurately fabricated and straightened at the shop after fabrication and galvanizing as necessary to conform to the concrete section.

6.9.2.6 Water stops

Water stops shall be of the type, size and shape shown on the plans. They shall be dense, homogeneous, and without holes or other defects.

6.9.2.7 Bitumen

Bitumen used for joint sealant should be of grade 90/40 (Oxidized Bitumen).

6.9.3 Installation

6.9.3.1 Open Joints

Open joints shall be constructed by the insertion and subsequent removal of a wood strip, metal plate or other approved material. The insertion and removal of the template shall be accomplished without chipping or breaking the corners of the concrete. When not protected by metal armor, open joints in decks and sidewalks shall be finished with an edging tool. Upon completion of concrete finishing work, all mortar and other debris shall be removed from open joints.

6.9.3.2 Filled Joints

When filled joints are shown on the plans, pre-molded type fillers shall be used unless polystyrene board is specifically called for. Filler for each joint shall consist of as few pieces of material as possible. Abutting edges of filler material shall be accurately held in alignment with each other and tightly fit or taped as necessary to prevent the intrusion of grout,. Joint filler material shall be anchored to one side of the joint by waterproof adhesive or other methods so as to prevent it from working out of the joint but not interfere with the compression of the material.

6.9.3.3 Sealed Joints

Prior to installation of pourable joint sealants, all foreign material shall be removed from the joint, the filler material shall be cut back to the depth shown or approved and the surface of the concrete which will be in contact with the sealant cleaned by light sand blasting. When required, a polyethylene foam strip shall be placed in the joint to retain the sealant and isolate it from the filler material. The sealant materials shall then be mixed and installed in accordance with the manufacturer's directions. Any material that fails to bond to the sides of the joint within 24 hours after placement shall be removed and replaced.

6.9.3.4 Water Stops

Adequate water stops of metal, rubber, or plastic shall be placed as shown on the plans. Where movement at the joint is provided for, water stops shall be of a type permitting such movement without injury. They shall be spliced welded, or soldered, to form continuous watertight joints. Precautions shall be taken so that the water stops shall be neither displaced nor damaged by construction operations or other means. All surfaces of the water stops shall be kept free from oil, grease, dried mortar, or any other foreign matter while the water stop is being embedded in concrete. Means shall be used to ensure that all portions of the water stop designed for embedment shall be tightly enclosed by dense concrete.

1. PVC Water Stops

PVC (polyvinylchloride) water-stops shall be extruded from an elastomeric plastic compound, the basic resin of which shall be polyvinylchloride. The compound shall contain such additional resins, plasticizers, stabilizers or other materials needed to ensure that when the material is compounded and extruded to the shapes and dimensions shown and tested it shall have the physical characteristics as shown in Table-18 'Physical Characteristics of PVC Water stop'.

Physical Characteristics	Test Method	Typical Values
Ultimate Elongation	ASTM D 638 (CRD C 573)	350 % min
Tensile Strength	ASTM D 638 (CRD C 573)	1750 psi (12.07 Mpa) min
Low Temperature Brittleness	ASTM D 746 (CRD C 570)	No Failure @ - 35 F (-37 C)
Stiffness in Flexure	ASTM D 747 (CRD C 571)	400 psi (2.76 Mpa) min
Specific gravity	ASTM D 792	1.37 max
Hardness, Shore A	ASTM D 2240	70 - 80

Table 18, Physical Characteristics of PVC Water Stop (Chapter 6)

2. Metal Water Stops

a. Copper

Copper water-stops shall conform to the requirements of ASTM B-370 and shall have the weight as shown in the Drawings.

b. Stainless Steel

Stainless steel water and grout stops shall conform to the requirement of ASTM A-167, Type 302 or 304.

c. Steel

Sheet steel for steel water-stops shall conform to the requirements of ASTM A-366 or ASTM A-569 where no welding is required and to ASTM A-4256 where welding is required.

d. Aluminum

Aluminum sheet for water-stops shall conform to the requirements of ASTM B-209.

e. Copper

Copper sheet water-stops shall conform to the requirements of ASTM B-152-97(a).

6.9.3.5 Expansion Joint Armor Assemblies

Armor assemblies shall be installed so that their top surface matches the plane of the adjacent finished concrete surface throughout the length of the assembly. Positive methods shall be employed in placing the assemblies to keep them in correct position during the placing of the concrete. The opening at expansion joints shall be that designated on the plans at normal temperature or as directed by the Engineer for other temperatures, and care shall be taken to avoid impairment of the clearance in any manner.

6.10 Curing Concrete

Concrete hardens because of chemical reactions between Portland cement and water. This process, known as hydration of cement, is not fully known but, it is believed that the principal reaction products are silicate gels which form at the surfaces of the cement grains and in the spaces between them. So long as the temperatures are favorable and the water necessary for the chemical reaction is present, the formation of gels proceeds from the surface of the grains inwards, gradually transforming them completely. The gel structure between the grains increase in density at the same time. The quality of the concrete, therefore, depends on the uninterrupted development of the hydration process.

The water used in mixing concrete is actually more than necessary to fill the inter-grain spaces. However, the loss from evaporation from the time of the initial set of the concrete is normally so rapid that the hydration process may be seriously affected. The Primary aid of curing is to prevent or replenish this loss of moisture during the early relatively rapid stage of hydration. The commonest method is to keep the exposed surface of the concrete continually moist by spraying, ponding, or covering it with earth, sand, straw or hessian maintained in a moist condition. Precast concrete is often cured in chambers in which steam is released, keeping the concrete moist. All these methods are collectively known as moist curing.

6.10.1 Effect of Temperature

The effect of temperature during curing in the rate at which concrete hardens. The best result is obtained when concrete hardens in a warm, damp atmosphere. If the weather is cold and the concrete is exposed to a temperature below 40 degrees Fahrenheit, the rate of hardening will be extremely slow and the concrete will have, for equal periods, considerably lower strength than concrete cured in a temperature of 70 degrees Fahrenheit. If, on the other hand, the concrete is exposed to a hot atmosphere and drying winds, there is a danger that the water required for hydration might evaporate and prevent the hardening of the concrete. Quick drying out of the concrete will also lead to contraction cracks, since the concrete is not hard enough at an early age to resist, without cracking, the stresses set up by contraction. Special precautions are, therefore, necessary during hot weather. Concreting should be done at night, using cold mixing water, sprinkling or covering aggregate, and avoiding the use of hot cement. To reduce absorption of mixing water the aggregates, wooden forms, sub-grade, foundation or other moisture absorbing surface should be well wetted before concreting. To lessen evaporation, the fresh concrete should be protected from the direct rays of the sun and from the drying wind. Mat canopies supported on light framework may be used for shading concrete.

6.10.2 Period of Curing

Specifications generally require that concrete must be kept moist for period of at least 7 days and preferable 14 days, when ordinary Portland cement is used. Rapidly hardening cements require less time (about half), and slowly hardening cements require more time, than ordinary Portland cement. When low-heat cement is used, the curing period must extend to 21 or 28 days.

6.10.3 Moist Curing

Moist curing is by far the easiest and most efficient method and is extensively used. It consists in the application of water direct to the concrete or by means of continuously saturated coverings of earth, sand, straw, Hessian, etc. Even when other methods are to be used, moist curing by means of spraying is usually specified for the first one or two days. Water should be applied on unformed surface as soon as it can be done without marring the surface and on formed surface immediately after the forms are stripped. Wooden forms, kept wet, and metal

forms provide satisfactory protection against loss of moisture. Hence, they should be left on as long as practicable. The exposed top surface should, however, be kept wet.

6.10.4 Spraying

If properly applied, spraying is a satisfactory method of curing formed or unformed surfaces and is also extensively employed in the curing yards of precast concrete factories, where mechanical sprinkles are usually installed. Spraying within the first few hours after concreting may wash some of the cement; hence Hessian should be used on unformed surfaces for several hours at least. Hand spraying may not in certain cases be quite satisfactory, because the surface is likely to get dry.

6.10.5 Ponding

This is a good method to use for flat horizontal surfaces such as floor slabs and pavements. Little earth dams are built over the surface to form squares which are flooded with water to a depth of 2 inches or so.

6.10.6 Wet Coverings

These consist of clean sand, straw, matting Hessian, gunny bags, canvas, etc., which must be kept saturated with water. Wet Hessian is particularly invaluable in that it can, unlike other wet-curing agents, be applied immediately after the finishing of the concrete without causing any damage to the surface. It is also very useful for curing vertical surface. In case wet earth or sand is used, it should be free from large lumps or stones, because they get dry more quickly.

6.11 Finishing Concrete Surfaces

6.11.1 General

Unless otherwise specified, after concrete has been consolidated and prior to the application of cure, all surfaces of concrete which are not placed against forms shall be struck off to the planned elevation or slope and the surface finished by floating with a wooden float sufficiently to seal the surface. While the concrete is still in a workable state, all construction and expansion joints shall be carefully tooled with an edger. Joint filler shall be left exposed.

1. Surface finishes for formed concrete surfaces shall be classified as follows: -

- Class 1 Ordinary Surface Finish
- Class 2 Rubbed Finish
- Class 3 Tooled Finish
- Class 4 Sandblast Finish
- Class 5 Wire Brush, or Scrubbed Finish

2. All concrete shall be given a class 1, Ordinary Surface Finish, and in addition if further finishing is required, such other type of finish as is specified.
3. If not otherwise specified, exposed surfaces except the soffits of superstructures and the interior faces and bottoms of concrete girders shall also be given a class 2, Rubbed Finish.
4. Class 3, 4, or 5 type surface finishes shall be applied only where shown on the plans or specified.

6.11.2 Finishing of Roadway Surface

All bridge decks, approach slabs, and other concrete surfaces for use by traffic shall be finished to a smooth skid-resistant surface in accordance with this article. During finishing operations, the contractor shall provide suitable and adequate work bridges for proper performance of the work, including the application of fog sprays and curing compound, and for inspecting the work.

6.11.2.1 Straight Edging

1. After the concrete is placed and consolidated according to Heading 6.7, top surface of structures serving as finished pavements shall be finished using approved power-driven finishing machines. Hand finishing methods may be used if approved by the Engineer for short bridges 50 feet or less in length or for irregular areas where the use of a machine would be impractical.
2. All surfaces shall be struck-off by equipment supported by and traveling on rails or headers. The rails, headers, and strike-off equipment shall be of sufficient strength and be adjusted so that the concrete surface after strike-off will conform to the planned profile and cross section.
3. The rails or headers shall be set on nonyielding supports and shall be completely in place and firmly secured for the scheduled length for concrete placement before placing of concrete will be permitted. Rails for finishing machines shall extend beyond both ends of the scheduled length for concrete placement a sufficient distance that will permit the float of the finishing machine to fully clear the concrete to be placed. Rails or headers shall be adjustable for elevation and shall be set to allow for anticipated

settlement, camber, and deflection of falsework, as necessary to obtain a finished surface true to the required grade and cross section. Rails or headers shall be of a type and shall be so installed that no springing or deflection will occur under the weight of the finishing equipment and shall be so located that finishing equipment may operate without interruption over the entire surface being finished. Rails or headers shall be adjusted as necessary to correct for unanticipated settlement or deflection that may occur during finishing operations. If rail supports are located within the area where concrete is being placed, as soon as they are no longer needed, they shall be removed to at least 2 inches below the finished surface and the void filled with fresh concrete.

4. Before the delivery of concrete is begun, the finishing machine or, if used, the hand-operated strike-off tool shall be operated over the entire area to be finished to check for excessive rail deflections, for proper deck thickness, and cover on reinforcing steel, and to verify operation of all equipment. Any necessary corrections shall be made before concrete placement is begun.
5. The finishing machine shall go over each area of the surface as many times as it is required to obtain the required profile and cross section. A slight excess of concrete shall be kept in front of the cutting edge of the screed at all times. This excess of concrete shall be carried all the way to the edge of the pour or form and shall not be worked into the slab, but shall be wasted.
6. After strike-off, the surface shall be finished with a float, roller, or other approved device as necessary to remove any local irregularities and to leave sufficient mortar at the surface of the concrete for later texturing.
7. During finishing operations, excess water, laitance, or foreign materials brought to the surface during the course of the finishing operations shall not be reworked into the slab, but shall be removed immediately upon appearance by means of a squeegee or straightedge drawn from the center of the slab towards either edge.
8. The addition of water to the surface of the concrete to assist in finishing operations will not be permitted.

6.11.2.2 Texturing

The surface shall be given a skid-resistant texture by either burlap or carpet dragging, brooming, tinning, or by a combination of these methods. The method employed shall be as specified or as approved by the Engineer. Surfaces that are to be covered with a waterproofing membrane deck seal shall not be coarse textured. They shall be finished to a smooth surface free of mortar ridges and other projections. This operation shall be done after floating and at such time and in such manner that the desired texture will be achieved while minimizing displacement of the larger aggregate particles.

6.11.2.3 Surface Testing and Correction

After the concrete has hardened, an inspection of finished deck roadway surfaces, which will not be overlaid with a wearing surface, will be made by the Engineer. Any variations in the surface which exceed 1/8 inch from a 10-foot straightedge will be marked. The Contractor shall correct such irregularities by the use of concrete planning or grooving equipment which produces a textured surface equal in roughness to the surrounding unground concrete without shattering or otherwise damaging the remaining concrete.

6.11.3 Pedestrian Walkway Surface Finish

After the concrete for sidewalks and decks of pedestrian structures has been deposited in place, it shall be consolidated and the surface shall be struck off by means of a strike board and floated with wooden or cork float. If directed, the surface shall then be lightly broomed in a transverse direction. An edging tool shall be used on edges and expansion joints. The surface shall not vary more than 1/8 inch under a 5-foot straightedge. The surface shall have a granular or matte texture that will not be slippery when wet. Sidewalk surfaces shall be laid out in blocks with an approved grooving tool as shown on the plans or as directed.

6.11.4 Finishing Formed Concrete Surfaces

6.11.4.1 Class -1 Ordinary Surface Finish

1. Immediately following the removal of forms, fins, and irregular projections shall be removed from all surfaces which are to be exposed or waterproofed. Bulges and offsets in such surfaces shall be removed with carborandum stones or discs.
2. Localized poorly bonded rock pockets or honey-combed concrete shall be removed and replaced with sound concrete or mortar. If rock pockets, in the opinion of the Engineer, are of such an extent or character as to affect the strength of the structure materially or to endanger the life of the steel reinforcement, he or she may declare the concrete defective and require the removal and replacement of the portion of the structure affected.
3. On all surfaces the cavities produced by form ties and all other holes, broken corners or edges, and other defects shall be thoroughly cleaned, and after having been thoroughly saturated with water shall be carefully pointed and trued with a cement: sand mortar conforming to Chapter-5 of Book-2. For exposed surfaces, white cement shall be added to the mortar in an amount sufficient to result in a patch which, when dry, matches the surrounding concrete. Mortar used in pointing shall be not more than 1 hour old. The concrete shall then be rubbed if required or the cure continued as specified under Heading 6.11.4. Construction and expansion joints in the completed work shall be left carefully tooled and free of mortar and concrete. The joint filler shall be left exposed for its full length with clean and true edges.
4. The resulting surfaces shall be true and uniform. Repaired surfaces the appearance of which is not satisfactory, shall be "rubbed" as specified under Class 2, Rubbed Finish.

6.11.4.2 Class-2 Rubbed Finish

1. After removal of forms, the rubbing of concrete shall be started as soon as its condition will permit. Immediately before starting this work, the concrete shall be thoroughly saturated with water. Sufficient time shall have elapsed before the wetting down to allow the mortar used in the pointing of rod holes and defects to thoroughly set. Surfaces to be finished shall be rubbed with a medium coarse carborandum stone, using a small amount of mortar on its face. The mortar shall be composed of cement and fine sand mixed in proportions used in the concrete being finished. Rubbing shall be continued until form marks, projections, and irregularities have been removed, voids have been filled, and a uniform surface has been obtained. The paste produced by this rubbing shall be left in place.
2. After other work which could affect the surface has been completed, the final finish shall be obtained by rubbing with a fine carborandum stone and water. This rubbing shall be continued until the entire surface is of a smooth texture and uniform color.

3. After the final rubbing is completed and the surface has dried, it shall be rubbed with burlap to remove loose powder and shall be left free from all unsound patches, paste, powder, and objectionable marks.
4. When metal forms, fiber forms, lined forms or plywood forms in good condition are used, the requirement for a Class 2, Rubbed Finish may be waived by the Engineer when the uniformity of color and texture obtained with Class I finishing are essentially equal to that which could be attained with the application of a Class 2, Rubbed Finish. In such cases, grinding with powered disc grinders or light sandblasting with fine sand or other means approved by the Engineer may be utilized in conjunction with Class I finishing.

6.11.4.3 Class-3 Tooled Finish

Finish of this character for panels and other like work may be secured by the use of a bush hammer, pick, Crandall, or another approved tool. Air tools, preferably shall be employed. No tooling shall be done until the concrete has set for at least 14 days and as much longer as may be necessary to prevent the aggregate particles from being "picked" out of the surface. The finished surface shall show a grouping of broken aggregate particles in a matrix of mortar, each aggregate particle being in slight relief.

6.11.4.4 Class-4 Sand Blasted Finish

The thoroughly cured concrete surface shall be sandblasted with hard, sharp sand to produce an even fine-grained surface in which the mortar has been cut away, leaving the aggregate exposed.

6.11.5 Wire Brushed or Scrubbed Finish

As soon as the forms are removed and while the concrete is yet comparatively green, the surface shall be thoroughly and evenly scrubbed with stiff wire or fiber brushes, using a solution of muriatic acid in the proportion of one part acid to four parts water until the cement film or surface is completely removed and the aggregate particles are exposed, leaving an even-pebbled texture presenting an appearance grading from that of fine granite to coarse conglomerate, depending upon the size and grading of aggregate used. When the scrubbing has progressed sufficiently to produce the texture desired, the entire surface shall be thoroughly washed with water to which a small amount of ammonia has been added, to remove all traces of acid.

6.11.6 Concrete Coloring

Concrete have color added to provide a look that fits with the architecture of the associated structure. This can be accomplished through mix-added pigments or post-cure staining, both of which are discussed below:

6.11.6.1 Pigments

Concrete coloring using pigments is a simple process, accomplished by adding the pigments directly to the concrete mix prior to pouring. Pigments are available in liquid form or in "mix-ready" dissolvable bags. In both cases, the pigments are placed in the mixer with the other concrete ingredient. The range of colors available is typically confined to "earthy" variants of browns and tans, although greens, blues and grays can also be purchased. It is important to

keep pigmented concrete well sealed throughout its lifetime in order to prevent water infiltration, which may cause the pigment to fade.

6.11.6.2 Concrete Stain

The color of concrete can also be manipulated through the use of various staining products. One common method of staining concrete is through the use of acid. Similar to concrete pigments, the range colors are typically confined to non-bright, relatively subtle tones. Water based (acrylic) staining provides for a much larger number of colors, including black and white. Stains can be applied to concrete of any age, though the colors are typically more vibrant if the stain is applied relatively soon after the concrete has been placed. Application of stain is typically followed up with installation of a seal over the concrete to protect the surface.

6.11.7 Concrete Polishing

Cured concrete, whether freshly-placed or well-aged, can be provided with a polished surface for a clean and glossy look, ease of maintenance and a surface that provides additional slip resistance over that of non-polished concrete.

The polishing process is typically accomplished using concrete floor grinders that are outfitted with diamond abrasives. The grade of the abrasives, from coarse to fine, will determine the final smoothness of the concrete surface at the completion of the polishing process. First, concrete is stripped of any existing sealer or coatings and any visible cracks are repaired. This is followed by the polishing process using the floor grinders mentioned above. Part way through the polishing process, chemical hardeners are often added to the concrete to provide future protection against water infiltration. Finer and finer abrasives are used until the desired surface finish is achieved. If desired, the final step involves application of a sealing product to protect the concrete from oil, chemicals, staining and moisture.

6.12 Pre-Cast Concrete Members

6.12.1 General

1. Precast concrete members shall be constructed and placed in the work in conformance with the details shown on the plans, specified or shown on the approved working drawings.
2. If approved by the Engineer, the use of precasting methods may be used for elements of the work which are otherwise indicated to be constructed by the cast-in-place method. When such pre-casting is proposed, the Contractor shall submit working drawings showing construction joint details and any other information required by the Engineer.

6.12.2 Pre-Casting Floor

In laying out the work yards the contractor shall provide a pre-casting floor of 3 to 1 concrete-in-mass at least 6 inches thick to be laid over the entire floor area where pre-casting is to be done. The surface of the floor shall be finished perfectly true and level with a steel troweled finish so as to produce even and fair beds for the concrete to be made thereon. Precaution shall be taken to prevent settlement of the floor should settlement take place the floor shall be re-laid or other means adopted to reinstate the level surface before it is used again. During the time the floor is in use it shall be kept true, level, clean and dry. Drains shall be provided to drain away the surplus water quickly and sufficient space shall be provided between the various molds to allow working room for handling them and clearing debris.

6.12.3 Materials and Manufacturing

1. The materials and manufacturing processes used for precast concrete members shall conform to the requirements of the other articles in this section except as those requirements are modified or supplemented by the provisions that follow.
2. When precast members are manufactured in established casting yards, the manufacturer shall be responsible for the continuous monitoring of the quality of all materials and concrete strengths. Tests shall be performed in accordance with appropriate ASTM methods. The Engineer shall be allowed to observe all sampling and testing and the results of all tests shall be made available to the Engineer.
3. Established, Precast Concrete Manufacturing Plants shall be approved by Building Research Station of Communication & Works Department for the category of work being manufactured.
4. Plant Quality Control personnel shall be certified in by I.S.O Quality Control Personnel Certification Program. Plant Quality Control Managers shall be also certified by I.S.O. These requirements may be met by alternative experience and certification considered to be equivalent.
5. Precast members shall be cast on unyielding beds or pallets. Special care shall be used in casting the bearing surface so that they will join properly with other elements of the structure.
6. For prestressed precast units, several units may be cast in one continuous line and stressed at one time. Sufficient space shall be left between ends of units to permit access for cutting of tendons after the concrete has attained the required strength.

7. The side forms may be removed as soon as their removal will not cause distortion of the concrete surface, providing that curing is not interrupted. Members shall not be lifted from casting beds until their strength is sufficient to prevent damage.
8. When cast-in-place concrete will later be cast against the top surfaces of precast beams or girders, these surfaces shall be finished to a coarse texture by brooming with a stiff coarse broom. Prior to shipment, such surfaces shall be cleaned of laitance or other foreign material by sandblasting or other approved methods.
9. When precast members are designed to be abutted together in the finished work, each member shall be match-cast with its adjacent segments to ensure proper fit during erection. As the segments are match-cast they must be precisely aligned to achieve the final structure geometry. During the alignment, adjustments to compensate for deflections shall be made.

6.12.4 Molds

Unless otherwise specified, the molds in which the concrete is precast shall consist of mild steel and shall not be less than 3/16 inches thick for small items and ¼ inch thick for large items, and suitable arrangements shall be made to prevent them from bulging. In all cases suitable precautions shall be taken to maintain the molds vertical, rectangular and with true faces during the time concrete is being filled in and packed. Core pieces of the required shapes to form chamfers, radii, joggle recesses, cavities, tongues, grooves, and other recesses or chassis shall be provided and firmly attached to the inside faces of the molds. Wooden molds may be used for small non-repetitive items.

6.12.4.1 Design of Molds and Lifting Apparatus approved

The general arrangement of the floor with its mixing machines, methods of supplying materials to the machines and transporting concrete from them and the detail designs of the molds shall be duly approved by the Engineer-in-charge. Methods of lifting precast concrete shall also be approved by the Engineer-in-charge.

6.12.4.2 Setting up Molds

The floor shall be thoroughly cleaned, dried and cleared of all cement, scum and debris before setting up the molds. The inside faces of the molds shall be thoroughly cleaned and, if necessary, scraped. The molds shall be set absolutely square and vertical. Their inside faces and the floor shall be coated with a vegetable oil or other parting agent duly approved so that concrete does not stick to them. The molds shall be maintained in a serviceable condition, all damaged fittings and core pieces shall be replaced when required, and the various parts shall be checked from time to time to see that no distortion or alternation in size has occurred.

6.12.4.3 Depositing concrete in Molds

Concrete shall be transported from the mixing machine to the molds as quickly as possible and shall be deposited and spread in them in layers. Each batch of concrete shall be well worked in and thoroughly packed against the faces of the molds. On the completion of each block, its top surface shall be well beaten down and struck off true and level by means of a long straight edge and finally floated off with a hand float. When the manufacture of an item has begun the supply of concrete shall be continuous and the item shall be finished off complete in one operation.

6.12.4.4 Removal of Molds

When the concrete has set sufficiently the sides and ends of a mold shall be slackened off and chased away from the face of the green concrete to allow the circulation of air but this shall not be done till 24 hours have elapsed since concreting was completed, except when items have hollow faces.

6.12.5 Storage and Handling

1. Extreme care shall be exercised in handling and moving precast prestressed concrete members. Precast girders shall be transported in an upright position and the points of support and directions of the reactions with respect to the member shall be approximately the same during transportation and storage as when the member is in its final position.
2. Prestressed concrete members shall not be shipped until tests on concrete cylinders, manufactured of the same concrete and cured under the same conditions as the girders, indicate that the concrete of the particular member has attained a compressive strength equal to the specified design compressive strength of the concrete in the member.
3. Care shall be taken during storage, hoisting, and handling of the precast units to prevent cracking or damage. Units damaged by improper storage or handling shall be replaced at the Contractor's expense.

6.12.6 Erection

1. The Contractor shall be responsible for the safety of precast members during all stages of construction. Lifting devices shall be used in a manner that does not cause damaging bending or torsional force. After a member has been erected and until it is secured to the structure, temporary braces shall be provided as necessary to resist wind or other loads.
2. Precast deck form panels shall be erected and placed so that the fit of mating surfaces shall be such that excessive grout leakage will not occur. If such fit is not provided, joints shall be dry-packed or sealed with an acceptable caulking compound prior to placing the cast-in place concrete. End panels for skewed structures may be sawed to fit the skew.

6.12.7 Curing

Unless otherwise permitted, precast members shall be cured by either the water method or the steam or radiant heat method.

6.12.8 Other Respects

- If the sides or ends of any precast concrete are not true as a result of the bulging of the mold or faulty setting, all such rounding or inequalities shall be dressed off neatly and accurately by masons so as to produce true and even faces when it is set in position. If honeycomb exists in a slight degree only it shall be slopped neatly and carefully with 2 to 1 cement mortar rubbed in with dry sand by means of a hand float fair with the general face of the block. Precast concrete that is irreparably out of square or badly honeycomb shall not be accepted for use in the permanent work.

- Broken or damaged precast concrete shall not be allowed to be set anywhere in the permanent work unless approved in writing the Engineer-in-charge and provided that the concrete shall be good and sound.
- No precast concrete shall be lifted off the floor till at least seven days have elapsed after pre-casting it. Its date of manufacture shall be legibly written on the top directly after it has been floated off and finished.
- The precast concrete after being cured shall be placed in stacks to mature and air space shall be left around each one of them.
- No precast concrete shall be set in the permanent work unless 4 weeks have elapsed since its date of manufacture.
- In all other respects precast concrete shall confirm to 6.1 for Cement Concrete (General).

6.13 Molded Cement Concrete Article

6.13.1 General

All coping, landing, steps, slabs, ashlar, and other similar things specified or shown on the drawings to be molded concrete shall consist of well-graded aggregate. The proportions of Portland cement shall be as specified. Concrete shall be cast in strongly proportioned molds fitted with all requites for the formation of chamfers, radii, V-grooves, recesses, Lewis holes, etc., to produce blocks perfect in shape, true to dimensions, having smooth and true faces and clearly defined chamfers, radii and sharp arises on all exposed edges.

6.13.2 Molding

Concrete shall be deposited slowly in layers, and shall be thoroughly worked in and packed so as to dispel all air and fill the molds perfectly. The molds shall not he slackened off or removed till a period of 36 hours has elapsed since the blocks were made. Immediately after the removal of molds, the back and side joints of the blocks against which the concrete is still green. No plastering of any exposed face or surface shall be allowed. All molded concrete shall be kept continuously watered for a period of at least 28 days after the molding.

6.13.3 Carborandum Non-Skid Surface

If so specified, the top surface of coping of all description and the treads of steps shall be impregnated with carborandum grains dusted through a No. 12 mesh hand-screen upon the concrete in such a manner as to ensure an even distribution. Rich superficial square yard of surface so treated shall receive 2¾ lbs. of carborandum grains which shall be well worked into the surface or the concrete by a wooded hand float.

6.13.4 Nipper Holes and V-Grooves

Nipper holes shall not be allowed in any exposed face whatsoever and if Lewis holes are to be provided, they shall be filled solid with 1 to 2 grouts at the same time as the joints are filled. Lewis holes shall not be allowed in copings, but V-grooves shall be provided which can be used for setting with chain clips.

6.13.5 Other Respects

In all other respects molded concrete shall conform to Specification for Precast Concrete.

6.13.6 Measurement and Payment

Concrete shall be measured to the neat lines of the structures as shown on the drawings or as modified by the Engineer-in-charge for the appropriate parts of the structure in which such concrete is incorporated. In measuring concrete, the volume of openings, recess ducts, embedded piping and metal work (each of which large than 36 square inches in cross-section) shall be deducted. Concrete shall be measured by volume. The unit of measurement shall be 100 cubic feet

6.13.7 Rate

The unit rate per 100 cubic feet shall include the cost of cement, sand, aggregate, water, mixing, placing, vibrating, curing, preparing, assembling and removing form, and all other operations, procedures and requirements necessary to finish the concrete in accordance with these specifications.

6.14 Mortar and Grout

6.14.1 General

This work consists of the making and placing of mortar and grout for use in concrete structures other than in prestressing ducts. Such uses include mortar for filling under masonry plates and for filling keyways between precast members where shown on the plans, mortar used to fill voids and repair surface defects, grout used to fill sleeves for anchor bolts, and mortar and grout for other such uses where required or approved.

6.14.2 Materials and Mixing

1. Materials for mortar and grout shall conform to the requirements of Article 20.3. The grading of sand for use in mortar when the width or depth of the void to be filled is less than $\frac{3}{4}$ inch shall be modified so that all material passes the No.8 sieve.
2. Type IA, air entraining, Portland cement shall be used when air entrainment is required for the concrete against which the grout or mortar is to be placed.
3. Unless otherwise specified or ordered by the Engineer, the proportion of cement to sand for mortar shall be one to two and for grout shall be one to one. Proportioning shall be by loose volume.
4. When no shrink mortar or grout is specified, either a no shrink admixture or an expensive hydraulic cement conforming to ASTM C 845 of a type approved by the Engineer, shall be used.
5. Only sufficient water shall be used to permit placing and packing. For mortar, only enough water shall be used so that the mortar will form a ball when squeezed gently in the hand.
6. Mixing shall be done by either hand methods or with rotating paddle type mixing machines and shall be continued until all ingredients are thoroughly mixed. Once mixed, mortar or grout shall not be re-tempered by the addition of water and shall be placed within 1 hour.

6.14.3 Placing and Curing

1. Concrete areas to be in contact with the mortar or grout shall be cleaned of all loose or foreign material that would in any way prevent bond and the concrete surfaces and shall be flushed with water and allowed to dry to a surface dry condition immediately prior to placing the mortar or grout.
2. The mortar or grout shall completely fill and shall be tightly packed into recesses and holes, on surfaces, under structural members and at other locations specified. After placing, all surfaces of mortar or grout shall be cured by the water method as provided in Heading 6.12 of these specifications for a period of not less than 3 days.
3. Keyways, spaces between structural members, holes, spaces under structural members, and other locations where mortar could escape shall be mortar-tight before placing mortar.
4. No load shall be allowed on mortar that has been in place less than 72 hours, unless otherwise permitted by the Engineer.
5. All improperly cured or otherwise defective mortar or grout shall be removed and replaced by the Contractor at own expense.

6.15 Application of Loads

6.15.1 General

Loads shall not be applied to concrete structures until the concrete has attained sufficient strength and, when applicable, sufficient prestressing has been completed, so that damage will not occur.

6.15.2 Earth Loads

Whenever possible the sequence of placing backfill around structures shall be such that overturning or sliding forces are minimized. When the placement of backfill will cause flexural stresses in the concrete, and unless otherwise permitted by the Engineer, the placement shall not begin until the concrete has reached not less than 80% of its specified strength.

6.15.3 Construction Loads

1. Light materials and equipment may be carried on floor slab / bridge decks only after the concrete has been in place at least 24 hours, providing curing is not interfered with and the surface texture is not damaged. Vehicles needed for construction activities and weighing between 1,000 and 4,000 pounds, and comparable materials and equipment loads, will be allowed on any span only after the last placed deck concrete has attained a compressive strength of at least 2,400 pounds are square inch. Loads in excess of the above shall not be carried on bridge decks until the deck concrete has reached its specified strength. In addition, for post-tensioned structures, vehicles weighing over 4,500 pounds, and comparable materials and equipment loads, will not be allowed on any span until the prestressing steel for that span has been tensioned.
2. Precast concrete or steel girders shall not be placed on substructure elements until the substructure concrete has attained 70% of its specified strength.
3. Otherwise, loads imposed on existing, new or partially completed portions of structures due to construction operations shall not exceed the load, carrying capacity of the structure, or portion of structure, as determined by the Load Factor Design methods of AASHTO using Load Group IB. The compressive strength of concrete (f') to be used in computing the load-carrying capacity shall be the smaller of the actual compressive strength at the time of loading or the specified compressive strength of the concrete.

6.16 Measurement and Rate

6.16.1 Measurement

1. Except for concrete in components of the work for which payment is made under other bid items, all concrete for structures will be measured by either the cubic foot or cubic meter for each class of concrete included in the schedule of bid items or by the unit for each type of precast concrete member listed in the schedule of bid items.
2. When measured by the cubic foot or cubic meter, the quantity of concrete will be computed from the dimensions shown on the plans or authorized in writing by the Engineer with the following exceptions.
3. The quantity of concrete involved in fillets, scorings and chamfers 1 square inch or less in cross-sectional area will not be included or deducted. Deductions for embedded materials as reinforcing, structural and prestressing steel, expansion joint filter material, water stops and deck drains will not be made.
4. When there is a bid item for concrete to be used as a seal course in cofferdams, the quantity of such concrete to be paid for shall include the actual volume of concrete seal course in place, but in no case shall the total volume to be paid for exceed the cubical contents contained between the vertical surfaces 1 foot outside the neat lines of the seal course as shown on the plans. The thickness of seal course to be paid or shall be thickness shown on the plans or ordered in writing by the Engineer.
5. The number of precast concrete members of each type listed in the schedule of bid items will be the number of acceptable members of each type furnished and installed in the work.
6. Whenever an alternative or option is shown on the plans or permitted by the specifications, the quantities of concrete will be computed on the basis of the dimensions shown on the plans and no change in quantities measured for payment will be made because of the use by the Contractor of such alternatives or options.
7. The number of moulded concrete articles of each type listed in the bid items will be number of acceptable numbers of each type furnished.

6.16.2 Rate

The unit rates for various types of Portland cement concrete, listed in table 1, shall be full compensation for all the work specified in this section including testing of concrete and shall also include all forms, false work, weep holes, drain setting anchor bolts and dowels, surface finish and cleaning up as shown on the drawings or ordered by the Engineer-in-charge.

6.17 Reinforced and Pre-stressed Cement Concrete

This work shall consist of pre-stressing, furnishing and placing precast concrete or cast-in place concrete members/ structures in accordance with details shown on the drawings and as specified in these specifications. The pre-stressing i.e., pre-tensioning or post tensioning shall be as per drawings. This Work shall include the furnishing and installation of all items necessary for the particular pre-stressing system to be used, including but not limited to pre-stressing and reinforcing steel, ducts, anchorage assemblies, bulkheads and grout used for pressure grouting ducts. The Work also includes curing, storing, transportation of pre-stressed members.

In this type of concrete work, designed and constructed in accordance with ACI code, the crushing strength of concrete f'_c shall not be less than 2500 psi. Requirements for f'_c shall be based on tests of cylinders made and tested as ASTM C39-93a. In all other respects, except the following it shall conform to 6.1 for Cement Concrete (General).

6.17.1 Material Requirements

6.17.1.1 High tensile Wire

Pre-stressing steel (Cables) shall be high-tensile wire conforming to ASTM Specification A-421 or AASHTO Designation M-204, strand or rope conforming to ASTM Specification A-416 or AASHTO Designation M-203 or high tensile alloy bars as follows: -

Grade MPa (Ksi)	Strand Designation No.	Día of strand mm (in)	Min Breaking strength of Strand KN (Lbf)	Steel Area of Strand, mm ² (in ²)	Weight of Strand kg/1000 m (lb. /1000 ft)
1725 (250)	6	6.4 (0.250)	40.0 (9,000)	23.2 (0.036)	182 (122)
	8	7.9 (0.313)	64.5 (14,500)	37.4 (0.058)	294 (197)
	9	9.5 (0.375)	89.0 (20,000)	51.6 (0.080)	405 (272)
	11	11.1 (0.438)	120.1(27,000)	69.7 (0.108)	548 (367)
	13	12.7 (0.500)	160.1(36,000)	92.9 (0.144)	730 (490)
	15	15.2 (0.600)	240.2 (54,000)	139.4 (0.216)	1094 (737)
1860 (270)	9	9.53 (0.375)	102.3(23,000)	54.8 (0.085)	432 (290)
	11	11.11(0.438)	137.9 (31,000)	74.2 (0.115)	582 (390)
	13	12.70(0.500)	183.7 (41,300)	98.7 (0.153)	775 (520)
	15	15.24(0.600)	260.7 (58,600)	140.0 (0.217)	1102 (740)

Table 19, Breaking Strength Requirements as per ASTM A-416 (Chapter 6)

Grade MPa (Ksi)	Strand Designation No.	Día of strand mm (in)	Initial Load KN (lbf)	Min Load at 1% Extension KN (lbf)	
				Low Relaxation	Normal Relaxation
1725 (250)	6	6.4 (0.250)	40.0 (9,00)	36.0 (8100)	34.0 (7650)
	8	7.9 (0.313)	64.5 (14,50)	58.1 (13,050)	54.7 (12,300)
	9	9.5 (0.375)	89.0 (2000)	80.1 (18,000)	75.6 (17,000)
	11	11.1 (0.438)	120.1(2700)	108.1 (24,300)	102.3 (23,000)
	13	12.7 (0.500)	160.1(3600)	144.1 (32,400)	136.2 (30,600)
	15	15.2 (0.600)	240.2 (5400)	216.2 (48,600)	204.2 (45,900)
1860 (270)	9	9.53 (0.375)	102.3(2300)	92.1 (20,700)	87.0 (19,550)
	11	11.11(0.438)	137.9 (3100)	124.1 (27,900)	117.2 (26,350)

	13	12.70(0.500)	183.7 (4130)	165.3 (37,170)	156.1 (35,100)
	15	15.24(0.600)	260.7 (5860)	234.6 (52,740)	221.5 (49,800)

Table 20, Yield Strength Requirements as per ASTM A-416

The steel shall be free from injurious defects and shall have a smooth surface. Material, which shows injuries defects during or prior to its installation in the work, shall be rejected. Strand shall be supplied in coils of sufficient diameter to ensure that they lie out straight. The Engineer-in-Charge may call for a relaxation test on pre-stressing steel in case, he is not satisfied with the source of manufacture. Relaxation for pre-stressing steel shall be measured over a period of thousand (1000) hours stressed at seventy (70) percent of its ultimate tensile strength giving less than six (6) percent elongation.

6.17.1.2 Sampling and Testing

Generally, all strands, or bars to be transported to the site shall be assigned a lot number and tagged for identification purposes. Anchorage assemblies to be transported shall be likewise identified. All samples submitted shall be representative of the lot to be furnished. All of the materials specified for testing shall be furnished free of cost and shall be delivered in time for tests to be made well in advance of anticipated time of use. The contractor shall furnish for testing the following samples selected from each lot as ordered by the Engineer-in-Charge. The selection of samples shall be made at the manufacturer's plant by the Engineer-in-Charge or his representative.

1. Pre-tensioning Method

Samples at least 2.1 meter (7 Ft) long shall be furnished of strand size. A sample shall be taken from each and every coil.

2. Post-tensioning Method

Samples of the following lengths shall be furnished. For wires, sufficient length to make up one parallel lay cable one and half (1.5) M long consisting of the same number of wires as the cable to be furnished. For strands, one and half (1.5) M (5 Ft) length shall be furnished. For bars to be furnished with threaded ends and nuts, one and half (1.5) M (5 Ft) between threads at end.

3. Anchorage Assemblies

Two anchorage assemblies of each size of anchorage to be used shall be furnished, complete with distribution plates. The RCC precast end block where used shall be of reinforced concrete manufactured in accordance with the provisions Plain & Reinforced Concrete. All anchorages and couplers for post-tensioning shall be capable of holding the prestressing steel at a load producing a stress of not less than ninety-five (95) percent of the specified ultimate tensile strength of the pre-stressing steel. The coupling of tendons shall not reduce the elongation at rupture below the requirements of the tendon itself. Couplers and coupler components shall be enclosed in housing long enough to permit necessary movements. Couplers shall not be used at points of sharp tendon curvature. The contractor shall prepare working drawings, backup calculations and material data for the bulk head, anchorages and couplers for pre-tensioning to be submitted to the Engineer in Charge for approval unless otherwise directed. Anchorage devices shall have a minimum clear concrete or grout coverage of 50 mm in every direction. Allowance for draw in of the tendon during anchoring shall be in accordance with the Engineers/Designers instructions, and the actual.

6.17.2 Construction Requirements

6.17.2.1 General

Unless otherwise ordered by the Engineer-in-Charge, the Contractor shall certify can sublet the work to approved specialized firm approved by the Engineer in Charge for pre-stressing / post-tensioning accompanied by experience certificates for similar projects including list of qualified technicians for completion of pre-stressing operations, equipment for jacking, calibration certificates for equipment to be used and methodology to be adopted for early completion of work The tensioning process shall be conducted so that the tension being applied and the elongation may be measured at all times.

6.17.2.2 Size of Aggregates

Unless otherwise specified, the nominal size of graded aggregate shall be:

- i. Floors, piers, abutments, and such like: 1½ inches to 3/16 inch.
- ii. Prestressed beams for: ¾ inch to 3/16 inch.

6.17.2.3 Reinforcement

Unless otherwise specified, reinforcement shall conform to 6.17. Reinforcement shall not be stacked on the ground to save it from mud, rust or other dangerous coatings, different sizes shall be stacked separately to facilitate identification. The bent bars ready for fixing shall be correctly marked in order that there is no difficulty in selecting the correct bars. The bars to be fixed shall be free from dust, oil, paint, rust or loose scale. All bending machine. No heating of bars shall be allowed except for fishtailing. Welding shall be permitted under suitable, conditions and safeguards in accordance with Pakistan standard Specification for Welding. Where the reinforcement is congested or complicated, spot welding shall be done for the assembling of reinforcement.

6.17.2.3.1 Placing Reinforcement

The number, size, length, form and position of all bars, links, stirrups, distance pieces and other member of the steel reinforcement shall be in exact accordance with the working drawings. The contractor shall take particular care that the reinforcement is laid out correctly in every respect and temporarily suspended by annealed wire or supported on small tapered concrete blocks in the forms to prevent displacement before or during the placing of concrete. Pieces of steel or wood shall not be used on the bottom boards or against the sides of moulds for this purpose. Stirrups and distance pieces shall be kept tight to the bars they embrace or support. Stirrups shall be kept away from the face of the concrete at the distance shown on the working drawings.

a. Laps Splices and Development length

Laps in any member shall be staggered. The length of lap splice shall be calculated as following:

i. Lap Splices in Tension

The required of lap for tension splices is stalled in terms of the development length l_d , the usual modification. factors are applied except that the reduction factor for excess reinforcement should not be applied because that factor is already accounted for in the splice specification.

Two different classifications of lap splices are established, corresponding to the minimum length of lap required: A Class A splice requires a lap of $1.0l_d$, and a class B splice requires a lap of $1.3l_d$, in either case, a minimum length of 12 in applies. Lap splices, in general, must be class B splices, according In ACI Code 12.15.2, except that class A splices are allowed when the area of reinforcement provided is at least twice that required by analysis over the entire length of the splice and when one-half or less of the total reinforcement is spliced within the required lap length.

ii. Compression Splices

Compression bars may be spliced by lapping, by direct end bearing, or by welding or mechanical devise that provide positive connection. The minimum length of lap for compression splices is set according to ACI Code 12.16:

For bars with $f_y \leq 60,000$ psi $0.0005 f_y d_b$

For bars with $f_y > 60,000$ psi $(0.0009 f_y - 24) d_h$

But not less than 12 in. For f_c' less than 3000 psi, the required lap is increased by $1/3^{\text{rd}}$. When bars of different size are lap spliced in compression, the splice length is to be the larger of the development length of the larger bar and the splice length or the smaller bar. In exception to the usual restriction on lap splices for large diameter bars, No. 14 and No. 18 bars may be lap spliced In No. 11 and smaller bars.

iii. Shear Reinforcement

All bent up bars acting as shear reinforcements shall be fully anchored in both flanges of the beam. The anchorage length shall be measured from the end of the sloping portion of the bar.

b. Hooks

Hooks shall be of such form, dimension and arrangement as to ensure their adequacy without over stressing the concrete or other anchorage material. They shall normally be of U-type, unless otherwise specified, and shall be of following dimensions:

- The internal radius of the bend should be at least twice the diameter of the bar except where the hook fits over a main reinforcing or other adequate anchor bar, when the radius of the bend may be reduced to that of such bar; and
- The length of straight bar beyond the end of the curve shall be at least four times the diameter of the bar.

c. Distance between Two Bars

- i. The horizontal distance between two parallel steel bars shall not be less than the three. following distances, unless otherwise specified:
 - The diameter of either bar, if their diameters are equal.
 - The diameter of the larger bar, if the diameters are unequal.

- ¼ inch more than the nominal; maximum size of the coarse aggregate used in the concrete.
- A greater distance shall be provided when convenient.
- ii. A vertical distance between the two horizontal main steel reinforcement or corresponding distance at right angle to two inclined main steel reinforcement shall not be less than ½ inch or the nominal maximum size of the aggregate whichever is greater; except where one of these reinforcements is transverse to the other.

d. Reinforcement

- Binding wire for steel reinforcement shall be soft annealed wire of No. 16 gauge and lashings. It shall be considered enough to secure the bars in position.
- After reinforcement has been placed and fixed in the correct position, no concreting shall done unless the Engineer-in-charge has inspected and approved it.
- Unless otherwise specified the following minimum thickness of concrete cover, exclusive of plaster or other decorating finish, shall be provided in all cases.

	<u>Minimum cover, in inches</u>
i. Concrete exposed to earth or weather:	
a. No.6 through No.18 bars	2
b. No.5 bar, W31 or D31 wire, and smaller	1-½
ii. Concrete not exposed to weather or in contact with ground:	
<u>Slabs, walls joist:</u>	
a. No. 14 and No.18 bars	1-½
b. No. 11 bar and smaller	¼
<u>Beams, Columns:</u>	
Primary reinforcement, ties, stirrups, spirals	1
<u>Shell, folded plate member:</u>	
a. No. 6 bar and larger	¾
b. No. 5 bar, W31 or D31 wire and smaller	1-½

6.17.2.4 Pre-stressing System

The pre-stressing system shall be as shown on drawings and indicated in the tender. The Contractor may opt for the alternate method of pre-stressing to be used, provided he introduces no change in the position of centroid of the total pre-stressing force over the length of the member and in the magnitude of the final effective pre-stressing force as prescribed in the Drawings. In case Contractor wants to use alternate systems provided in the drawings, he shall provide details of the system he proposes to use to the Engineer in Charge for his approval the alternate option shall be subject to all requirements hereinafter specified.

- The safety of the anchorage of the pre-stressing tendons and their suitability for the transmission of forces to the concrete under all loads whatsoever.
- That the actual losses due to friction coincide with the calculated ones for the prestressing.
- The suitability of the proposed steel for the chosen pre-stressing system.
- The length of transmission of the force to the concrete and the minimum strength of the latter necessary for pre-stressing in systems, where the pre-stressing elements are fully or partially anchored to the concrete through bond and friction.
- The suitability of measures taken to protect pre-stressing tendons from corrosion until the final tensioning is carried out.

The Contractor shall submit well in advance to the Engineer-in-Charge for approval complete details of the methods, materials, and equipment he proposes to use in the prestressing operations. Such detail shall outline the method and sequence of stressing, complete specifications and details of the pre-stressing steel and anchoring devices proposed for use, anchoring stresses, type of enclosures, and all other data pertaining to the pre-stressing operation, including the proposed arrangement of the pre-stressing units in the members.

An agreement certificate for the pre-stressing system shall be submitted and approved by the Engineer-in-Charge before any structural member to be pre-stressed may be tensioned, this agreement certificate must be issued by an authorized testing laboratory otherwise the Engineer-in-Charge may order such an agreement certificate from a laboratory of his choice at the cost of the Contractor. All rules referring to this agreement certificate here in after are subject to the approval of the Engineer-in-Charge. In his submittal, the Contractor will also describe techniques he intends to use for: -

- Placing ducts and strands
- Making ducts completely tight against accidental entrance of laitance during concreting.
- Pre-stressing operations and measurement of elongation.
- Injection
- Cutting of tendons surplus, and filling anchorage recesses.

He will also ensure that all precautions will be taken for the protection of pre-stressing steel, ducts, anchorages, jacking and grouting equipment's and all miscellaneous items. Protection will be on storage areas, and also at every stage of construction until injection by grouting and concreting of anchorages recesses. All type of protections will be described in details (methodology and materials) by the Contractor in his submittal. As for the "storage of materials on site" he will follow AASHTO-Standard Specifications-Division II 10.6. It is ensured that all these precautions will be sufficient to ensure that the friction coefficient of strands/ducts will be included between 0.20 and 0.24 and no oxidation on steel (ducts and strands) will occur.

6.17.2.5 Pre-stressing Equipment

Hydraulic jacks shall be equipped with accurate pressure gauges. The contractor may elect to substitute screw jacks or other types for hydraulic jacks. In that case, proving rings or other approved devices shall be used in connection with the jacks (at least three (3) functional jacks will be provided on the job in good condition). All devices, whether hydraulic jack gauges or otherwise, shall be calibrated so as to permit the stress in the pre-stressing steel to be computed at all times. A certified calibration curve shall accompany each device. Safety measures shall be taken by the Contractor to prevent accidents due to possible breaking of the pre-stressing steel or the slipping of the grips during the pre-stressing process. All equipment's shall be thoroughly washed with clean water at least once every three (3) hours during the grouting operations and at the end of use for each day.

1. Grouting Equipment

Grouting equipment shall be capable at a pressure of at least seven (7) Kg/sq. cm (100 psi). Grouting equipment shall be furnished with a pressure gauge having a full-scale reading of not more than 20 Kg/sq. cm (284.5 psi). Reciprocating pumps or equipment that produces a pulsating flow shall not be used. Grouting equipment shall be thoroughly washed with clean

water at least once every three (3) hours during grouting operations and at the end of use each day. Grout injection pipes shall be fitted with positive mechanical shut off valves. Vents and ejection pipes shall be fitted with valves capable of withstanding the pumping pressure.

6.17.2.6 Enclosure

Enclosures for pre-stressing steel shall be accurately placed at locations shown on the plans or approved by the Engineer-in-Charge. All enclosures shall be of strong ferrous metallic material and shall be completely mortar tight with the exception that the contractor, at his option, with the approval of the Engineer in- Charge, may form the enclosures by means of cores or ducts composed of rubber or other suitable material which can be removed prior to installing the pre-stressing reinforcement. Enclosures shall be strong enough to maintain their shape under such forces as will be imposed upon them. They shall be six (6) mm larger in internal diameter than the bar, cable, strand or group of strands, which they enclose. Where pressure grouting is specified, cores or ducts shall be provided with the pipes or other suitable connection for the injection of grout after the pre-stressing operations have been completed.

When approved by the Engineer in Charge, ducts shall be of the flexible, corrugated type, delivered to the site on large diameter wooden drums. Ducts shall be protected from rusting, damage, oil or any other deleterious matter. Ducts shall have sufficient strength to maintain their correct alignment during placing of concrete and shall be bent without crimping or flatter. Joints in adjacent ducts shall be staggered by at least 300 mm. Waterproof tape shall be used at the connections.

6.17.2.7 Placing Steel (Spacer)

All steel units shall be accurately placed in the position shown on the Drawings or required by the Engineer-in-Charge and firmly held during the placing and setting of the concrete. Distance from the forms shall be maintained by stays, blocks, ties, or hangers approved by the Engineer-in-Charge. Blocks for holding units from contact with the forms shall be precast mortar blocks of approved shape and dimensions. Layers of units shall be separated by mortar blocks or other equally suitable devices. Wooden blocks shall not be left in the concrete. Suitable horizontal and vertical spacers shall be provided, if required, to hold the wires in place in true position in the enclosure. Density of supports, their stiffness and accuracy of position are parameters that affect the loss of tension in cables due to wobbling. The Contractor will take all suitable provisions to reduce this "wobbling effect. In particular, the space between two supports will be less than 1m.

6.17.2.8 Depositing Concrete in Forms

Concrete shall be deposited in the forms in layer or as best suited to the work in hand. Concrete shall be well packed and rammed between and around reinforcement. Flat wooden tools, rammers and spatulas and subsequently vibrators shall be employed to ensure compact concrete and smooth surface to the face work. Great care shall be exercised to prevent the displacement or bending or any portion of reinforcement.

6.17.2.9 Pre-Tensioning

The pre-tensioning elements shall be accurately held in position and stressed by jacks. A record shall be kept of the jacking force and the elongation produced thereby. Several units may be cast in one continuous line and stressed at one time. Sufficient space shall be left

between ends of units, if necessary, to permit access for cutting after the concrete has attained the required strength. No bond stress shall be transferred to the concrete, nor end anchorages released, the concrete has attained a compressive strength, as shown by cylinder tests, of at least two hundred and eighty (280) Kg/sq.cm (4000 psi), and as approved by the Engineer-in-Charge. The elements shall be cut or released in such an order that lateral eccentricity of pre-stress will be minimum. The contractor shall submit design and drawings along with the backup calculations and material data for the bulk head, anchorages and couplers for pre-tensioning of viaduct for Engineer approval.

6.17.2.10 Post Tensioning

Tensioning shall be carried out only in the presence of the Engineer-in-Charge or his representative unless permission has been obtained to contrary. Immediately before tensioning, the contractor shall prove that all tendons are free to move between jacking points and that members are free to accommodate the horizontal and vertical movements due to the applications of pre-stress. Tensioning of pre-stressing reinforcement shall not be commenced until tests on concrete cylinders, manufactured of the same concrete and cured under the same conditions, indicate that the concrete of the particular member to be pre-stressed has attained a compressive strength of at least 280 Kg/sq.cm (4000 psi) by cylinder tests. After the concrete has attained the required strength, the pre-stressing reinforcement shall be stressed by means of jacks to the required tension and stress transferred to the end anchorage(s). Stressing shall be from both ends unless otherwise required in the Contract or agreed by the Engineer-in-Charge. The tensioning process shall be so conducted that the tension being applied and the elongation of the pre-stressing elements may be measured at all times. The friction loss in the elements, i.e. the difference between the tension at the jack and the minimum tension in the pre-stressing steel shall be determined by the formula.

$$FT = 2\left(1 - \frac{a.c.e}{d}\right)$$

Where

FT = total friction loss

F1 = observed tension at the jack

a = cross sectional area of the pre`-stressing element

c = observed elongation of the element when the force at the jack is F1.

E = secant modulus of elasticity of the element for stress F1 as determined from the stress-strain diagram of the element.

D = Distance from the jack to the point of lowest tension in the element. Where jacking is done from both ends of the members; the point of minimum tension is the center of the member. Where jacking is done from one end only. D is the distance to the other end of the member.

Any surplus length of tendon shall be cut off by an approved method which will not affect the strength of the stressed tendon, with particular care if the use of spark erosion or oxyacetylene burning methods of cutting are approved by the Engineer-in-Charge. A record shall be kept of gauge pressures and elongation at all times and submitted to the Engineer-in-Charge for his approval within twenty-four (24) hours of each tensioning operation. The tendons shall be maintained in such a condition that they can be re-stressed until the Engineer-in-Charge has given final approval after inspecting the tensioning log. After cutting surplus length of cables, recess will be filled with concrete having a compressive cylinder strength of 280 Kg/cm² (4000 Psi).

6.17.2.11 Grouting of Bonded Steel

1. Grout

It shall be a mixture of Portland cement, water and approved admixtures. Composition of the mix shall be submitted to the Engineer in Charge for approval, along with the following information: -

- The nature, quality and origin of the constituents.
- Measure by weight of each constituent,
- Sequence of mixing

The cement will be Portland cement that does not exhibit phenomenon of "false setting" (Test of Tusschenbrook), without any Sulphur ions S^{--} , with a chloride ions Cl^- less than 0.05%, and without any element susceptible to induce corrosion of steel.

- The water will not contain chloride ions Cl^- more than 500 mg/l, sulphate ions SO_4^{--} more than 400 mg/l, and no detergent.
- Type of admixtures
- Admixtures, if used, should impact the properties of low water content, good flow ability, minimum bleed and expansion if desired. Its formulation should contain no chemicals in quantities that may have harmful effect on the prestressing steel or cement. Admixtures containing chlorides (as Cl^- in excess of 0.5% by weight of admixture), fluorides, sulfites and nitrate shall not be used.

All admixtures should be used in accordance with the instructions of the manufactures. The submittal will include the chemical composition of the grout and results of laboratory tests for the following features: -

- Sweating
- Fluidity
- Mechanical Strength

2. Sweating

The quantity of water due to sweating at the surface of the grout maintained at rest during three (3) hours must be less than 2% of the volume of the grout; this water must be totally re-absorbed twenty-four (24) hours after the mixing.

3. Fluidity

The flow-out time through the MARSH cone with a 10 mm diameter hole, will be included between 13 and 25 seconds during the time foreseen for the grouting, and at least for 1 hour, at a temperature of 32°C.

4. Portland Cement

Portland cement conforming to ASTM C150

5. Mechanical Strength

- Three days 230Kg/sq. cm
- Seven days 300Kg/sq. cm
- Twenty-eight days 350Kg/sq. cm

6. Grouting Operation

AASHTO-Standard Specifications-Division II -10.6 & 10.9 will be followed. Note that mixing water will have to be cooled in summer when temperature of concrete will be above 32°C.

7. Quality Control

a. Laboratory tests

They will be made to verify the suitability of the grout composition to the intended basic features here above specified.

b. Checking tests on site

Checking for sweating and fluidity will be made 24 hours before beginning of the injections at the conditions that will really prevail at the injection time; same materials and equipment's will be used for that purpose. Results of tests will be transmitted to the Engineer in Charge for approval.

c. Tests during grouting operations

For each operation, three series of fluidity tests will be made. Each series consists of one test on the grout at the entry vent and one test on the grout at the exit vent. Results of tests will be transmitted to the Engineer in Charge as well as quantities of grout actually consumed for each duct.

6.17.2.12 Handling

Precast pre-stressed concrete members shall be transported in an upright position and the points of support with respect to the member shall be approximately the same during transportation and storage as when the member is in its final position. In the event that the Contractor deems it expedient to transport or store precast girders in other than this position it should be done at his own risk. Care shall be taken during storage, hoisting, and handling of the pre-casting units to prevent cracking or damage. Units shall be lifted and supported at the designated lift points only. Units damaged by improper storing or handling shall be replaced by the Contractor at his expense. Pre-stressed structural members shall be constructed in conformity with the drawings governing the particular type of structure to be built or as required by the Engineer-in- Charge. Working Shop Drawings of handling and all operations to the final positioning of girders will be submitted to the Engineer in Charge. If permanent displacements of the piers/abutments or of the neoprene bearings are induced as a result of Contractor's methodology, these displacements will be calculated by the Contractor and provisions, like jacking, will be provided by him at his own cost to relieve the structure of these displacements. Calculations notes showing that stability of beams, inclusive lateral buckling, are ensured at every stage until concreting & achieving desired compressive strength of diaphragms and deck slab. This submittal does not relieve the Contractor of his full responsibility during handling, transport, placing, and attached operations like jacking or slinging.

6.17.2.13 Precast Prestressed Members

- The details of the method of manufacture shall be approved by the Engineer in Charge before work is started. When the method has been approved, no changes shall be made without the consent of the Engineer-in-Charge.
- The Contractor shall inform the Engineer-in-Charge in advance of the date of commencement of manufacture and the dates when tensioning of tendons, casting of members and transfer of stress will be undertaken for the first time for each type of beam.
- The Contractor shall send to the Engineer-in-Charge not more than seven (7) days after the transfer of stress, a certificate showing the force and strain in the tendons immediately after they were anchored, the strength and age of the test cubes in accordance with specified procedure and the minimum age in hours of the concrete at the time the stress was applied to the member. A copy of all twenty-eight (28) days cube or cylinder test results relating to the work shall be sent to the Engineer-in-Charge as these become available. Records shall be kept so that the identity of those who stress the tendons, cast the concrete and transfer the stress on any member or line of members can be traced.
- Where the Engineer-in-Charge's Representative requires tests to be carried out, no beams to which the test relate shall be dispatched to the site until the tests have been satisfactorily completed.

6.17.2.14 Composite Slab Bridge

- The manufacturing tolerances for the precast members shall nowhere exceed those given for the length, cross section and straightness in BS Code of Practice CP 116 (1969), "the structural use of precast concrete". In addition, where beams are laid side by side in a deck: -
- The difference in soffit level between adjacent units before the in-situ concrete is placed shall nowhere exceed five (5) mm for units up to five (5) meters nor ten (10) mm for longer units.
- The width of the deck soffit shall be within plus twenty-five (+ 25) mm of that described in the Contract.
- In adjacent spans, the continuity of line of the outside beams shall be maintained.
- The width of the gap between individual beams shall not exceed twice the nominal gap described in the Contract.
- The alignment of transverse holes shall permit the reinforcement or pre-stressing tendons to be placed without distortion.
- The in-situ concrete shall be placed in such a sequence that the advancing edge of the freshly deposited concrete over the full width of deck or between longitudinal construction joints is approximately parallel to the deck supports.
- Beams shall be prevented from moving laterally during the placing of the in-situ concrete.

6.17.2.15 Removal of Forms

In all cases the contractor shall satisfy himself that reinforced and prestressed concrete has thoroughly set before removing formwork and shuttering or supports and shall obtain the

permission of the Engineer-in-charge before removing formwork, shuttering and support. The following minimum times shall elapse after depositing reinforced concrete in forms before the latter may be removed.

	Cold Weather	Hot Weather
Sides to piers, abutments, berms, etc.	03 days	02 days
Props to slabs and beams	10 days	07 days
Props to beams and slabs in composite action	14 days	10 days

Table 21, Minimum Time Required for Removal of Formwork (Chapter 6)

Shuttering of the hollow sides of the prestressed concrete bridge beams shall, however, be removed before concrete starts shrinking.

6.17.2.16 Curing

1. General

- For all pre-stressed concrete operations, the curing procedures shall be well established and properly controlled. Curing shall be commenced immediately following initial set or completion of surface finishing. Members shall be kept wet during the entire period of curing.
- The curing shall conform to Plain & Reinforced Concrete and as approved by the Engineer-in-Charge.

6.17.3 Measurement and Payment

6.17.3.1 Composite Rates

The measurement and payment for the items of the work of Pre-Stressed Concrete hereof shall be made corresponding to the applicable CSR items as provided in Contract Agreement and shall constitute full compensation, for procurement, transportation, performance in all respects and completion of work as specified including the site clearance as approved by the Engineer-in-Charge.

6.17.3.2 Labor Rates

The measurement and payment for the items of the work of Pre-Stressed Concrete hereof shall be made corresponding to applicable CSR item as provided in Contract Agreement and shall constitute full compensation for procurement transportation, performance in all respects and completion of work as specified including site clearance, as approved by the Engineer-in-Charge except the cost of materials to be provided by Department at designated location as defined in the Contract Agreement.

6.18 Lime Concrete

6.18.1 Material Requirements

- **Aggregate:** Aggregate shall consist of brick ballast, broken stone or shingle. It shall comply with the specification for Coarse Aggregate given in Book 1 (Specification for Engineering Material).
- **Size of Aggregate:** Unless otherwise specified or directed, the size of the aggregate shall not exceed 1½ inches gauge for ordinary lime concrete and ¾ inch gauge for fine lime concrete. All coarse aggregate shall be screened through ¼ inch mesh to remove dust and rubbish.
- **Lime:** Unless otherwise specified, lime shall be stone lime and shall comply with Specification No.3.2 of Book-1(Specification for Engineering Material) for stone Lime.
- **Surkhi:** Surkhi shall comply with Specification for 'Surkhi' given in Book-1 (Specification for Engineering Material).
- **Proportion:** Unless otherwise specified, concrete for ordinary works shall consist of 13 cubic feet of lime and 26 cubic feet of Surkhi mixed with 100 cubic feet of aggregate. For importance work the proportion shall be 17 cubic feet of lime, 34 cubic feet of Surkhi and 100 cubic feet of aggregate, all mixed dry before the addition of water.
- **Soaking:** If aggregate is brick ballast. it shall be soaked by heavily sprinkling with water for at least 3 hours before the layer of Surkhi and lime is added.
- **Platform for Stacking and Making:** The material shall be measured and mixed on a pacca platform and protected from any admixture of earth, dirt or other foreign matter. The measurement shall be done by stacking the ballast in a rectangular layer of one-foot thickness and spreading on its top the mixed Surkhi and lime in uniform layer of thickness to give the specified proportion.

6.18.2 Construction Requirements

6.18.2.1 Mixing, Laying and Ramming

- The materials shall be turned over 3 times dry and 3 times wet. The quantity of water which shall be added by means of a can fitted with a rose shall be just enough to make a wet, but not sloppy, concrete. No further water shall be added either during or ramming.
- The ramming shall at one be laid (not thrown from a height) in layer not exceeding 6 inches in thickness, and thoroughly consolidated with rammers. Square rammers shall be used for consolidating the edges. Consolidation is not considered complete till a skin of pure mortar covers the surface and completely hides the aggregate and till a stick dropped endways from a height rebounds with a ringing sound.
- The mixing and ramming shall go on continuously when once started. No concrete shall be placed later than 2 hours before work is stopped for the day.

6.18.2.2 Test

Unless otherwise specified, the following test shall be applied. 2-days after ramming is completed, a hole shall be made, wherever directed by the Engineer-in-charge, and filled with water. If the water is retained in the hole, it means the concrete is good and well compacted; otherwise is retained in the hole, it means the concrete is good and well compacted; otherwise (if the water runs through), the concrete is either not properly rammed or the quantity of mortar

used is insufficient. Any layer of concrete which fails to pass this test shall be removed and replaced by sound and well-rammed concrete at the expense of the contractor.

6.18.2.3 Joints

The lower layer shall in each case be swept and washed clean before the next is laid. Where joints in layers are unavoidable, the end of each layer shall be sloped at an angle of 30° . Where vertical joints occur in an upper and lower layer, they shall be at least 2 feet apart horizontally.

6.18.2.4 Curing

When completed, concrete shall be kept wet for a period of not less than 14 days. No brickwork or masonry shall be laid on concrete for at least 7 days after lying.

6.18.2.5 Protection

In all concrete work suitable plans and gangways shall be provided to prevent traffic over the surface of the work.

6.18.3 Measurement and Rates

In respect of measurement and rate it shall conform to Specification for chapter-6 concrete (General) given in this chapter.

6.19 Reinforcement

6.19.1 Description

This work shall consist of furnishing and placing reinforcing steel in accordance with these Specifications and in conformity with the plans. Over all reinforcement should fulfilled the criteria of ASTM A-615.

Bars extending out of finished concrete should be protected against possible damage and corrosion to ensure good continuity with further construction.

6.19.2 Materials

Bars are of five minimum yield strength levels: namely, 40 000 psi [280 MPa], 60 000 psi [420 MPa], 75 000 psi [520 MPa], 80 000 psi [550 MPa], and 100 000 psi [690 MPa], designated as Grade 40 [280], Grade 60 [420], Grade 75 [520], Grade 80 [550], and Grade 100 [690], respectively.

Bars are of five minimum yield strength levels: namely, 40 000 psi [280 MPa], 60 000 psi [420 MPa], 75 000 psi [520 MPa], 80 000 psi [550 MPa], and 100 000 psi [690 MPa], designated as Grade 40 [280], Grade 60 [420], Grade 75 [520], Grade 80 [550], and Grade 100 [690], respectively.

Bar Designation No.	Nominal Weight, lb./ft [Nominal Mass, kg/m]	Nominal Dimensions ^A			Deformation Requirements, in. [mm]		
		Diameter, in. [mm]	Cross-Sectional Area, in. 2 [mm ²]	Perimeter, in. [mm]	Maximum Average Spacing	Minimum Average Height	Maximum Gap (Chord of 12.5 % of Nominal
3 [10]	0.376 [0.560]	0.375 [9.5]	0.11 [71]	1.178 [29.9]	0.262 [6.7]	0.015 [0.38]	0.143 [3.6]
4 [13]	0.668 [0.994]	0.500 [12.7]	0.20 [129]	1.571 [39.9]	0.350 [8.9]	0.020 [0.51]	0.191 [4.9]
5 [16]	1.043 [1.552]	0.625 [15.9]	0.31 [199]	1.963 [49.9]	0.437 [11.1]	0.028 [0.71]	0.239 [6.1]
6 [19]	1.502 [2.235]	0.750 [19.1]	0.44 [284]	2.356 [59.8]	0.525 [13.3]	0.038 [0.97]	0.286 [7.3]
7 [22]	2.044 [3.042]	0.875 [22.2]	0.60 [387]	2.749 [69.8]	0.612 [15.5]	0.044 [1.12]	0.334 [8.5]
8 [25]	2.670 [3.973]	1.000 [25.4]	0.79 [510]	3.142 [79.8]	0.700 [17.8]	0.050 [1.27]	0.383 [9.7]
9 [29]	3.400 [5.060]	1.128 [28.7]	1.00 [645]	3.544 [90.0]	0.790 [20.1]	0.056 [1.42]	0.431 [10.9]
10 [32]	4.303 [6.404]	1.270 [32.3]	1.27 [819]	3.990 [101.3]	0.889 [22.6]	0.064 [1.63]	0.487 [12.4]
11 [36]	5.313 [7.907]	1.410 [35.8]	1.56 [1006]	4.430 [112.5]	0.987 [25.1]	0.071 [1.80]	0.540 [13.7]
14 [43]	7.65 [11.38]	1.693 [43.0]	2.25 [1452]	5.32 [135.1]	1.185 [30.1]	0.085 [2.16]	0.648 [16.5]

18 [57]	13.60 [20.24]	2.257 [57.3]	4.00 [2581]	7.09 [180.1]	1.58 [40.1]	0.102 [2.59]	0.864 [21.9]
20 [64] ^B	16.69 [24.84]	2.500 [63.5]	4.91 [3167]	7.85 [199.5]	1.75 [44.5]	0.113 [2.86]	0.957 [24.3]

Table 22, Deformed Bar Designation Numbers, Nominal Weights [Masses], Nominal Dimensions, and Deformation Requirements (Chapter 6)

6.19.3 Bar Lists and Bending Diagram

When the plans do not include detailed bar lists and bending diagrams, the Contractor shall provide such lists and diagrams to the Engineer for review and approval. Fabrication of material shall not begin until such lists have been approved. The approval of bar lists and bending diagrams shall in no way relieve the Contractor of responsibility for the correctness of such lists and diagrams. Any expense incident to the revision of material furnished in accordance with such lists and diagrams to make it comply with the design drawings shall be borne by the Contractor.

6.19.4 Fabrication

6.19.4.1 Bending

Bar reinforcement shall be cut and bent to the shapes shown on the plans. All bars shall be bent cold, unless otherwise permitted. Bars partially embedded in concrete shall not be field bent except as shown on the plans or specifically permitted.

6.19.4.2 Hooks and Bend Dimension

The dimensions of hooks and the diameters of bends measured on the inside of the bar shall be as shown on the plans. When the dimensions of hooks or the diameter of bends are not shown, they shall be in accordance with ACI 318, "Building Code Requirements for Reinforced Concrete".

6.19.4.3 Bar Bending Machine

Bar bending machine of approved quality and standard should be used at site for bar bending. Before establishing bar bending machine contractor will be responsible to approve machine from Engineer in Charge as per the requirement of project.

6.19.4.3.1 Precautionary measures

- A steel bar bending machine is a heavy, powerful machine. It must not be operated by inexperienced workers and operatives of the machine must have a very good understanding of the functioning and method of operation of the machine.
- Bar bending machines should be placed on firm, level ground, with sufficient clearance allowing safe access and operations.
- Moving parts and cutters on metal bar fixed machines for cutting, bending etc should be guarded.
- Work pieces or materials should be secured or gripped to prevent whiplashing or flying offcuts etc.
- Do not allow operators to operate the steel bar bending machine under the influence of alcohol, drugs or medication.

- Provide sufficient information and safe work procedures for operating bar bending machines, training and supervision to operators/workers.
- Duty of contractor to provide and maintain plant and equipment that is safe and without risk to health.

6.19.5 Handling, Storage, Surface Condition and testing of Reinforcement

Steel reinforcement shall be stored above the surface of the ground on platforms, skids, or other supports and shall be protected from mechanical injury and surface deterioration caused by exposure to conditions producing rust. When placed in the work, reinforcement shall be free from dirt, loose rust or scale, mortar, paint, grease, oil, or other nonmetallic coatings that reduce bond. Reinforcement, shall be free from injurious defects such as cracks and laminations. Bonded rust, surface seams, surface irregularities, or mill scale will not be cause for rejection, provided the minimum dimensions cross-sectional area, and tensile properties of a hand wire brushed specimen meet the physical requirements for the size and grade of steel specified.

6.19.5.1 Deformation Requirement

Deformation requirement should meet the table-17 of these specifications.

6.19.5.2 Tensile Requirement

- The material, as represented by the test specimens, shall conform to the requirements for tensile properties prescribed in Table -18 'Tensile Requirements'.
- The yield point or yield strength shall be determined by one of the following methods:
 -
- The yield point shall be determined by the drop or halt of the gauge of the tensile testing machine, where the steel tested has a sharp-kneed or well-defined yield point.
- Where the steel tested does not have a well-defined yield point, the yield strength shall be determined by the offset method (0.2 % offset), as described in Test Methods and Definitions A370.
- When material is furnished in coils, the test specimen shall be taken from the coil and straightened prior to placing it in the jaws of the tensile testing machine.

Note: Straighten the test specimen to avoid formation of local sharp bends and to minimize cold work. Insufficient straightening prior to attaching the extensometer can result in lower-than-actual yield strength readings.

- Test specimens taken from post-fabricated material shall not be used to determine conformance to this specification.

Note: Multiple bending distortion from mechanical straightening and fabricating machines can lead to excessive cold work, resulting in higher yield strengths, lower elongation values, and a loss of deformation height.

- The percentage of elongation shall be as prescribed in Table-18 'Tensile Requirements'.

	Grade 40 [280]^A	Grade 60 [420]	Grade 75 [520]	Grade 80 [550]	Grade 100 [690]
Tensile strength, min, psi [MPa]	60000 [420]	90000 [620]	100000 [690]	105000 [725]	115000 [790]
Yield strength, min, psi [MPa]	40000 [280]	60000 [420]	75000 [520]	80000 [550]	100000 [690]
Elongation in 8 in. [200 mm], min, % Bar Designation No.					
3 [10]	11	9	7	7	7
4, 5 [13, 16]	12	9	7	7	7
6 [19]	12	9	7	7	7
7, 8 [22, 25]	---	8	7	7	7
9, 10, 11 [29, 32, 36]	---	7	6	6	6
14, 18, 20 [43, 57, 64]	---	7	6	6	6

Table 23, Tensile Requirements (Chapter 6)

^A Grade 40 [280] bars are furnished only in sizes 3 through 6 [10 through 19].

6.19.5.3 Bending Requirement

- The bend-test specimen shall withstand being bent around a pin without cracking on the outside radius of the bent portion. The requirements for degree of bending and sizes of pins are prescribed in Table- 'Bend Test Requirements'. When material is furnished in coils, the test specimen shall be straightened prior to placing it in the bend tester.
- The bend test shall be made on specimens of sufficient length to ensure free bending and with apparatus that provides: -
 - Continuous and uniform application of force throughout the duration of the bending operation.
 - Unrestricted movement of the specimen at points of contact with the apparatus and bending around a pin free to rotate.
 - Close wrapping of the specimen around the pin during the bending operation.
 - It shall be permissible to use other methods of bend testing as described in Test Methods E290, such as placing a specimen across two round bearings free to rotate and applying the bending force with a fixed rounded-tip mandrel conforming to the specified bend radius, allowing the bar to pass through with sufficient clearance. When failures occur under other methods of bend testing, retests shall be permitted under the bend-test method prescribed in 6.19.5.3(2).

Bar Designation No.	Pin Diameter for Bend Tests^A				
	Grade 40 [280]	Grade 60 [420]	Grade 75 [520]	Grade 80 [550]	Grade 100 [690]
3, 4, 5 [10, 13, 16]	3 1/2 d B	3 1/2 d	5d	5d	5d
6 [19]	5d	5d	5d	5d	5d
7, 8 [22, 25]	---	5d	5d	5d	5d
9, 10, 11 [29, 32, 36]	---	7d	7d	7d	7d
14, 18 [43, 57] (90°)	---	9d	9d	9d	9d
20 [64] (90°)	---	10d	10d	10d	---

Table 24, Bend Test Requirements (Chapter 6)

6.19.5.4 Sampling and Testing

Sampling and testing should be taken as per approved standard practices and ASTM A-615. Any lot rejected by Engineer in charge based on test results should be promptly returned to the manufacture and contractor will be responsible for changing such reinforcement lot and if any bar used, from such lot, in any structural member should be replaced by contractor. No extra payment will be given for such replacement.

6.19.6 Placing and Fasting

6.19.6.1 General

Steel reinforcement shall be accurately placed as shown on the plans and firmly held in position during the placing and consolidation of concrete.

6.19.6.2 Support System

Reinforcing steel shall be supported in its proper position by use of precast concrete blocks wire bar supports, supplementary bars or other approved devices. Such reinforcement supports or devices shall be of such height and placed at sufficiently frequent intervals so as to maintain the distance between the reinforcing steel and the formed surface or the top surface of slabs within $\frac{1}{4}$ inch of that indicated in the plans. Platforms for the support of workers and equipment during concrete placement shall be supported directly on the forms and not on the reinforcing steel.

6.19.6.3 Pre-Cast Concrete Blocks

Precast concrete blocks shall have a compressive strength not less than that of the concrete in which they are to be embedded. The face of blocks in contact with forms for exposed surfaces shall not exceed 2 inches by 2 inches in size and shall have a colour and the texture that will match the concrete surface. When used on vertical or sloping surface such blocs shall have an embedded wire for securing the block to the reinforcing steel. When used in slabs, either such a tie wire or when the weight of the reinforcing steel is sufficient to firmly hold the blocks a place, a groove in the top of the block maybe used.

6.19.7 Splicing of Bars

6.19.7.1 General

All reinforcement shall be furnished in the full lengths indicated on the plans unless otherwise permitted. Except for slices shown on the plans and lap slices for No.5 or smaller bar, splicing of bars will not be permitted without written approval. Splices shall be staggered as far as possible.

6.19.7.2 Lap Splicing

Lap splices shall be of the lengths shown on the plans. If not shown on the plans, the length of lap splices shall be approved by the Engineer. In lap splices, the bars shall be placed and tied in such a manner as to maintain the minimum distance to the surface of the concrete

shown on the plans. Lap splices shall not be used for Nos. 14 and 18 bars except as approved by the Engineer.

6.19.7.3 Welded Splices

Welded splices of reinforcing bars shall be used only if detailed on the plans or if authorization is made by the Engineer in writing. Welding shall conform to the Structural Welding Code, Reinforcing Steel, ANSI AWS D1.4 of the American Welding Society and applicable special provisions in the contract documents.

6.19.8 Substitutions

Substitution of different size reinforcing bars will be permitted only when authorized by the Engineer. The substituted bars shall have an area equivalent to the design area, or larger.

6.19.9 Measurements and Rates

6.19.9.1 Measurements

Steel reinforcement incorporated in the concrete will be measured in pounds / Kg on the total computed weight for the sizes and lengths of bars. The weight of bars will be computed using the following weights:

Bar Size	Weight lbs. per in feet
3	0.376
4	0.668
5	1.043
6	1.502
7	2.044
8	2.670
9	3.400
10	4.303
11	5.313
14	7.65
18	13.60

Table 25, Bar Sizes and Weight of bars (Chapter 6)

No allowance will be made for clips, wire, separators, wire chairs, and other material used in fastening the reinforcement in place, if bars are substituted upon the Contractor's request and as a result more reinforcing steel is used than specified, only the amount specified will be included. The additional reinforcing steel required for splices that are not shown on the plans but are authorized as provided herein, will not be included.

6.19.9.2 Rates

The unit rate for the quantity of reinforcement determined under measurement for each class of reinforcing steel shown in the bid schedule will be made at the contract price per pound / Kg. Reinforcement steel to be full compensation for furnishing, fabricating, splicing, and placing of the reinforcing steel including all incidental work and materials required as per above specifications specially included in the contract.

6.20 Damp Proof Course

6.20.1 Cement Concrete D.P.C.

6.20.1.1 Description

This specification covers providing and laying Damp Proof Course horizontally or vertically of specified material in specified ratio. Unless otherwise specified Damp Proof Course shall be laid in accordance with the specifications.

6.20.1.2 Materials

- a) Cement shall confirm to the chapter 3 of Book – 1 (Specification for Engineering Material) of these specifications.
- b) Fine aggregate shall confirm to the chapter 3 of Book – 1 (Specification for Engineering Material) of these specifications.
- c) Coarse aggregate shall confirm to the chapter 3 of Book – 1 (Specification for Engineering Material) of these specifications.
- d) Water shall confirm to the chapter 3 of Book – 1 (Specification for Engineering Material) of these specifications.
- e) Bitumen shall confirm to the chapter 3 of Book - 1 (Specification for Engineering Material) of these specifications.

6.20.1.3 Operation

Unless otherwise specified, concrete DPC shall consist of laying of cement concrete of specified thickness over the masonry wall covering entire width of the wall.

6.20.1.4 Concrete

Unless otherwise specified, cement concrete in DPC shall be of ratio 1:2:4 by volume and shall conform to chapter 6 of these specification for cement concrete.

6.20.1.5 Preparation of Base

Before laying Damp Proof Coarse bottom surface of masonry shall be cleaned, it shall be clear from plaster, dust and other foreign matters.

6.20.1.6 Mixing & Placing

Mixing and placing of concrete shall be in accordance with the of these specifications for cement concrete.

6.20.1.7 Finishing

The surface shall be leveled with a wooden trowel. The fines in the concrete which have come to the surface with the stroking quickly but carefully smoothed with the steel trowel.

6.20.1.8 Curing

Unless otherwise specified, the DPC shall be cured by water curing for a period of seven days and then surface shall be allowed to dry.

6.20.1.9 Bitumen Coating

Bitumen shall be heated to a temperature specified by the manufacture and specified number of coats shall be applied on the surface to be treated. Minimum thickness of a coat shall be 1/16th of an inch.

6.20.1.10 Polythene Sheet

Polythene sheet of specified gauge shall be laid over the bitumen to the entire width of DPC.

6.20.1.11 Measurement

The cement concrete DPC shall be measured by superficial area. The unit of measurement shall be 100-Sq ft/ Sq. Mtr.

6.20.1.12 Rate

1. Labor Rate

The unit rate shall include

- a) Washing and cleaning of masonry base.
- b) Mixing, placing, finishing and curing of topping concrete.
- c) Laying coat of bitumen.
- d) Laying a layer of polyethene sheet.

2. Composite Rate

The unit rate shall include the cost of material specified for carrying out work in addition to the labor rate as detail in 6.20.1.12.1 above.

6.20.2 DPC Of Cement Sand Plaster

6.20.2.1 Description

This specification covers providing and laying Damp Proof Course of cement sand plaster of specified ratio and thickness. Unless otherwise specified cement sand plaster damp proof course shall be laid in accordance with the specifications.

6.20.2.2 Materials

- a) Cement shall confirm to the chapter 3 of Book – 1 (Specification for Engineering Material) of these specifications.
- b) Fine aggregate shall confirm to the chapter 6 of Book - 1 (Specification for Engineering Material) of these specifications.
- c) Water shall confirm to the chapter 1 of Book – 1 (Specification for Engineering Material) of these specifications.
- d) Bitumen shall confirm to the chapter 12 of Book – 1 (Specification for Engineering Material) of these specifications.
- e) Unless otherwise specified, cement sand mortar shall confirm to chapter 5 of Book - 2 of these specifications for preparation of mortar.

6.20.2.3 Operation

Unless otherwise specified, DPC shall consist of applying cement sand plaster of specified thickness and ratio over the masonry work horizontally/vertically.

6.20.2.4 Preparation of Mortars

The following preparation (by volume) of dry material shall be used as specified.

Cement	:	Sand
1		2
1		3
1		4

6.20.2.5 Preparation of Base

Before laying Damp Proof Course bottom surface of masonry shall be cleaned to remove all loose dust and other foreign matters and surface then thoroughly washed with water.

6.20.2.6 Plastering

Plastering shall be done in accordance with these specifications for cement plaster.

6.20.2.7 Bitumen Coating

Bitumen shall be heated to a temperature specified by the manufacturer and specified number of coats shall be applied on the surface to be treated. Minimum thickness of a coat shall be 1/16th of an inch.

6.20.2.8 Polythene Sheet

Polythene sheet, where required shall of specified gauge and shall be laid on the entire surface of DPC.

6.20.2.9 Measurement

The cement sand plaster DPC shall be measured by superficial area. The unit of measurement shall be 100-sq ft/ sq.m.

6.20.2.10 Rate**1. Labor Rate**

The unit rate shall include:

- a) Washing and cleaning of masonry base.
- b) Mixing, placing, finishing and curing of cement sand plaster.
- c) Laying coat of bitumen.
- d) Laying a layer of polyethene sheet.

2. Composite Rate

The unit rate shall include the cost of material specified for carrying out work in addition to the labour rate as detail in 6.20.2.10.1 above.

6.20.3 Marble DPC**6.20.3.1 Description**

This specification covers providing and laying Marble Damp Proof Course of specified thickness. Unless otherwise specified marble damp proof course shall be laid in accordance with the specifications.

6.20.3.2 Material

1. Marble Slab

- a) Marble Slab shall be conforming to the specifications contained in chapter 5 of Book - 1 of these specifications.
- b) Marble stone slab shall be of specified thickness, width in accordance to the wall to be covered and appropriate length.
- c) All slabs shall have a true plain surface and shall be accurately sawn, truly square at edges to full thickness. The slabs at corners shall be cut at 45° angles.

2. Mortar

Cement sand Mortar 1:2 conforming to the specification as contained in chapter 5 of Book – 2.

6.20.3.3 Construction Requirements

1. Preparation of Base

Before laying Marble Slabs, the surface of the base shall be washed & Scrubbed with wire brush.

2. Bedding Mortar

Marble Slabs shall be laid over bedding Mortar not more than $\frac{3}{4}$ ".

3. Joints

No joints shall be more than $\frac{1}{16}$ of an inch in thickness.

4. Laying

Slabs shall be laid in position on bedding mortar and shall cover full width of masonry wall, the joints shall be filled with specified mortar.

5. Levels

The surface of the Marble DPC Slabs when laid shall be perfect and true in levels.

6. Curing & Protection

The Marble DPC shall be kept watered for seven day. Three clear days shall be given for setting before any one is allowed to walk over. Further work shall not be executed before seven days after laying of DPC.

6.20.3.4 Measurement

The measurements of Marble DPC shall be done by the superficial area. The unit of measurement shall be 100-Sq feet / Sq. meter.

6.20.3.5 Rate**1. Labor Rate**

The unit rate shall include.

- a) Washing scrubbing & cleaning of masonry base.
- b) Laying of bedding Mortar.
- c) Laying of marble DPC slabs over bedding Mortar.
- d) Filling of joints with specified mortar.

2. Composite Rate

It includes the cost of all the material supplied at site of work as per these specifications, in addition to the labor rate detailed in 6.20.3.5.1 above.

6.20.4 Jutoid (Jute Based) DPC**6.20.4.1 Description**

This specification covers providing and laying Damp Proof Course of Jutoid of specified thickness. Unless otherwise specified cement sand plaster damp proof course shall be laid in accordance with the specifications.

6.20.4.2 Materials**1. Jutoid**

- a) Normal weight of jutoid shall be 3.5-kg/sq.m.
- b) Manufactured by an approved manufacturer.

2. Mortar

Cement: Sand mortar of 1:2 ratio shall conform to chapter 5 of Book - 2 of these specifications.

6.20.4.3 Preparation of Base

Jutoid DPC shall be laid on smooth surface free from sharp protrusions. In case of rough surface, a layer of 1:4 cement sand plaster $\frac{1}{2}$ " thick is done in accordance to the chapter 3 of Book - 1 of these specifications for cement sand plaster.

6.20.4.4 Laying

Jutoid D.P.C is laid over the walls & it shall cover full width of the wall.

6.20.4.5 Lap

A minimum of 3" lap shall be provided.

6.20.4.6 Rate**1. Labor Rate**

The unit rate shall include, cleaning surface & laying of Jutoid D.P.C.

2. Composite Rate

The unit rate shall include the cost of materials specified for carrying out work in addition to the labor rate as detail in 6.20.4.6.1 above except the cost of cement sand plaster which will be paid separately if required & executed.

6.21 Cement Concrete Block Masonry

6.21.1 Scope

The work under this section of the specifications consists of furnishing all plant, labour, equipment, appliances and materials and performing all operations in any floor and at any height in connection with the supply and installation of ordinary cement concrete Solid block masonry work including wall ties, anchors, damp-proof courses, complete in strict accordance with this section of the Specifications and applicable drawings, and subject to the terms and conditions of the Contract.

6.21.2 Materials

6.21.2.1 For Block

Cement, aggregates and water for concrete blocks shall conform to the requirements as specified for Plain and Reinforced Concrete.

6.21.2.2 For Mortar

The cement and sand mortar for concrete block masonry shall specified.

1. Sand

Sand for mortar shall comply with the requirements for BS-1200. It shall be graded in accordance with the following table and the various sizes of particles shall be uniformly distributed. Sand that has been in contact with seawater shall not be used unless it has been thoroughly washed to the satisfaction of the Engineer-in-Charge.

Sieve Size Number	Percent Passing by Weight	
	Min.	Max.
#4	100	Not Applicable
#8	95	100
#16	70	100
#30	40	75
#50	10	35
#100	2	15
#200	0	0

Table 26, Grading Requirements (Chapter 6)

2. Cement

Cement shall be Ordinary Portland Cement conforming to BS-12.

3. Water

Water shall be clean and free from any harmful impurity. Where the quality of the water is doubtful, it shall be tested in accordance with BS- 3148. The water shall comply with the provisions as given below:

- a) The water for curing, for washing aggregates and for mixing shall be subject to the approval of the Engineer in charge. Generally, it should be free from oil and the turbidity limit shall not exceed 2000 parts per million and the pH value shall range between 6.0 to 8.0. In no case shall the water contain an amount of impurities that will cause a change in the setting time of Portland cement of more than twenty-five (25) % nor a

reduction in the compressive strength of mortar at fourteen (14) days of more than five (5) % when compared to the result obtained with distilled water the water shall be free from oil, alkali, vegetable matter, salt and other impurities. If the specific conductance is less than fifteen hundred (1500) microohms per centimeter, the total solids content requirement may be waived. Water for washing aggregates, mixing, and curing shall contain no chlorides as Cl, nor sulfates as exceeding the values for the type of the work as follows: -

Type of Work	Chlorides (ppm)	Sulphates (ppm)
Conventionally Reinforced	500	1000
Pre-stressed Concrete	500	1000

Table 27, Chlorides and Sulphates Amount in Water (Chapter 6)

- b) In non-reinforced concrete work, the water for curing, for washing aggregates and for mixing shall be free from oil and shall not contain more than two thousand (2,000) parts per million of chlorides nor more than one thousand five hundred (1,500) parts per million of sulfates as SO₄. In addition to the above requirements, water for curing concrete shall not contain any impurities in a sufficient amount to cause discoloration of the concrete or produce etching of the surface. When required by the Engineer in charge, the quality of the mixing water shall be determined by the Standard Method of Test for Quality of Water to be used in concrete, AASHTO Ts 26.

4. Additives

Additives where used, shall be proprietary products used in the proportions and manner recommended by the manufacturer. The additives shall in no way adversely affect the mortar strength or contain chemicals, which may be harmful to other building materials. To add gypsum to cement is strictly forbidden.

5. Mortars and Grout

Materials for mortar, sand and binding agent and water, shall be mixed by volume or by weight as specified for at least 3 minutes with the minimum amount of water to produce a correctly mixed mortar or grout of workable consistency in a mechanical batch mixer. For small jobs, hand mixing may be permitted, the ingredients being mixed with sufficient water to produce a correctly mixed workable mortar. Mortar shall be as strong, but no stronger than the materials it bonds together. Mortars shall be mixed in batches, which can be used within a period before the setting process commences. Once a mix begins drying off, it shall be rejected. No ingredients shall be added to it once the setting process has begun.

6.21.3 Concrete Block Making

The Solid blocks shall be factory manufactured/fabricated and be machine moulded. The block making machines shall be of the standard approved by the Engineer-in-Charge. They shall be operated according to the instructions laid down by the manufacturers. The contractor shall submit samples/literature of various manufacturers for Engineer-in-Charge's approval. The contractor should note that only blocks supplied by the approved manufacturer(s) shall be allowed to be used in the work. The blocks shall be continuously water cured by sprinkling water for a minimum of 10 days and covered between sprinkling operations with 4 mils thick polyethylene sheeting. After 10 days water curing period the blocks shall be air-dried. Under no circumstance's blocks will be used in the work until they are completely dry. During curing period no surfaces of the block will be allowed to dry. Cured concrete blocks shall be stored off the ground, stacked on level platforms which allow air circulation under stacked units. Units shall be covered and protected against wetting. Care shall be exercised in the handling of all concrete blocks. No damaged blocks shall be used in the work. The hollow blocks shall be

manufactured as per pattern shown on the drawing. These block units shall be provided by the Contractor for use where required in building structures from approved type of materials. Units shall have uniformly fine smooth surfaces of uniform color. These shall be free of any honey combing or other imperfections or deformations, all edges true and straight, and at right angles with each other and without any chipped or otherwise broken edges. The blocks cast on different dates shall be stacked separately and must be labelled showing the date on which they were cast. Reinforced cement concrete hollow block masonry shall be provided where shown on the drawings. Hollow block manufactured by molding machine shall have well-formed cavities, sharp and well-defined edges and corners, smooth surfaces without any imperfections or deformations.

6.21.4 Properties of Blocks

All blocks shall be of the size and shape required to complete the work shown in the Drawings or as instructed by the Engineer-in-Charge. The cement, sand and coarse aggregate shall be volume batched and their proportion may be adjusted so as to provide the concrete of the required strength when tested and shall be mixed in a concrete mixer. All blocks shall comply with ASTM C-55-03 edition. The compressive strength of various Solid blocks shall be as follows:

Sr. #	Type of Concrete Masonry	Compressive Strength (Psi)		Location
		Average of 3 Units	Individual Unit	
1	Solid load bearing Masonry units (ASTM-C-145-85)	2000 psi minimum	2000	Exposed to frost action
2	Solid/Hollow non-load bearing Masonry units (ASTM-C-90-85)	600	500	Not exposed to moisture & weather
3		700	600	Not exposed to moisture & weather

Table 28, Properties of Solid Blocks (Chapter 6)

Normally 1:3:6 concrete mix should meet the above strength requirement. The specific gravity should be between 2.3 to 2.4. The proportion shall however be confirmed by contractor by trial mix and approved by Engineer-in-Charge for actual site conditions. The Contractor shall provide test certificates providing the average minimum crushing strength of the blocks prior to the commencement of the construction. Further test certificates shall be provided as required by the Engineer-in-Charge to ensure that all batches of blocks have the minimum specified crushing strength. A laboratory approved by the Engineer-in-Charge shall carry out the test. Evidence shall be produced that the block manufacturer has an efficient method of quality control. The Engineer in- Charge will require to test samples of blocks periodically and the Contractor shall make necessary arrangements accordingly. The method of sampling for all tests shall be in accordance with ASTM standards referred in Section 9.4.3.

6.21.5 Suction Rate

The Contractor shall, at his own cost, satisfy the Engineer-in-Charge that the suction rate of the block when determined in accordance with Appendix "A" of BS 3921 does not exceed 20 g/dm²/ min. or that the Contractor is able to adjust it so that it does not exceed this value on site.

6.21.6 Soluble Salt Content

For exposed blockwork, the contents by weight percent of soluble sulphate, calcium, magnesium, potassium and sodium radicals, shall not exceed 0.30, 0.10, 0.30, 0.03 and 0.03, percent respectively when ascertained in accordance with BS 3921, at the cost of the Contractor.

6.21.7 Reinforcing and Anchors of Block Masonry

Unless otherwise stated reinforcing and anchors shall conform to under-mentioned sizes: -

Joint reinforcing shall be 1.32mm (0.05-inch) diameter mild steel wire mesh design, galvanized after fabrication. Steel wire woven into 12mm mesh 75mm wide. Reinforcing bar anchors shall be 25 mm dia. deformed bar minimum 10 inch long. Two 6mm dia bar shall be provided at every fourth course for anchoring of block masonry to columns. Two 10 mm bars at every fourth horizontal course shall be provided for anchoring masonry walls to plinth beam/floor beam, as shown on the drawings. Dovetail anchors and slots (if used as an alternate anchorage) shall be not less than 18-gauge galvanized steel.

6.21.8 Erection

Blocks shall be laid true to line, level and laid in accurately spaced courses in stretcher bond with vertical joints of each course located at centre of units in alternate courses below. Vertical joints shall be buttered in the entire height of blocks. Each course shall be bonded at corners and at intersections of walls and shall be properly bonded. Courses of block shall be kept plumb throughout and corner reveals shall be true and in plumb. Standard width of mortar joints for both horizontal and vertical joints shall be 10mm (maximum). Mortar joints in walls shall have full mortar coverage on vertical and horizontal faces between the blocks. Mortar joints on wall including struck joints, shall be thoroughly compacted and pressed tight against the edges of the blocks with proper tools. Blocks terminating against soffits of beam or slab construction shall be wedged tight with wedges and the joints shall be packed solidly with mortar between the top of the block and the bottom of slab or beam. Control expansion joints shall be kept free from mortar or other debris. Unless otherwise shown on the drawings or specified by the Engineer-in-Charge, the spaces around doorframes and other material or built in items shall be solidly filled with mortar. Spaces around the door and window holdfasts shall be filled in with 1:3:6 concrete. Work required to be built in with masonry including doorframe anchors, wall plugs, and dovetail anchors and accessories shall be built in as the erection progresses. The block work shall be carried up in a uniform manner and no portion shall be carried more than one meter above the adjoining one at any time. All masonry shall be kept strictly true and square and the whole properly bonded together and levelled round each floor. Sleeves, Chases, holes, sinking and mortices for other trades shall be correctly located and formed to the sizes as required by the relevant trades. Chiseling of completed walls or the formation of holes shall only be carried out as per design drawings with the approval of the Engineer-in-Charge. Walls of blocks indicated, as being non-load bearing shall be constructed on the in-situ concrete floor slab unit after the floor formwork is struck and the concrete has obtained sufficient strength to support their-weight. Tothing into load-bearing walls shall not be permitted. All bolts, anchors, ties, pipe sleeves, flushing metal attachments, lintels and the like required to be built into the work shall be correctly inserted and executed as the work proceeds. Walls or partitions abutting concrete columns or walls shall be securely anchored and tied with metal anchors or ties at not more than 450mm vertical centers. Wall ties cast in with concrete shall be bent down after the removal of formwork and shall be securely jointed into the mortar beds of walling. Care shall be taken during construction of cavity walls so as to avoid the filling up of cavity with mortar. G.I. flashing and weep holes shall be provided wherever specified on the drawings or as per the instructions of the Engineer-in-Charge. Weep holes will be formed by oiled rods, removed after the mortar is set, at specified locations.

6.21.9 Scaffolding

Contractor shall provide safe scaffolding of adequate strength for use of workmen at all levels and heights at his own expense. Scaffolding which is unsafe in the opinion of the Engineer in Charge shall not be used until it has been strengthened and made safe for use of workmen. Cost of scaffolding etc. shall be included by the Contractor in the unit rate for masonry items. Damage to masonry from scaffolding or from any other object shall be repaired by the Contractor at his own cost.

6.21.10 Jointing

Jointing is the forming of joints as work proceeds. Joints shall be as follows: -

- a) Exterior exposed joints shall be tightly formed to a weather joint with the point of the trowel.
- b) Interior exposed joints shall be tightly formed to a concave joint.
- c) Joints which are subsequently covered with plaster or other finish materials shall be struck flush.

6.21.11 Tolerances

All block work shall be erected plumb and true to line and level with the maximum variation in any storey height or any length of wall being one mm in one meter. The maximum tolerance in the length, height or width of any single masonry unit shall be ± 3 mm.

6.21.12 Damp Proof Course

Damp-proof course shall be laid on an even mortar bed, free from projections, which may puncture the material. Where the damp-proof course is to be stepped, only flexible membrane shall be used. All damp-proof course, unless otherwise specified, shall consist of 1:2:4 cement concrete 50mm thick, mixed with 2.5 kg of pudlo per bag of cement or other approved quality water proofing compound as per manufacturer's specifications and shall be laid at required levels as per drawings and instructions of the Engineer-in-Charge. The D.P.C shall be tamped consolidated, levelled, edges and corners made to the requirements of concerned drawings including finishing and curing complete.

6.21.13 Solid Block Work Around Opening of Hollow Masonry

Around all openings in hollow block masonry, the Contractor shall provide solid block work of same thickness as that of hollow block masonry wall and of width as indicated on the Drawings. Solid block shall be laid around openings in such a manner that these are bonded integrally with hollow block masonry.

6.21.14 Curing and Repairs

All block masonry shall be water cured and shall be kept wet for at least seven days, by an approved method, which will keep all surfaces to be cured continuously wet. Water used for curing shall meet the requirements of the specifications for water used in the manufacture of blocks. If, after the completion of any block masonry, the work is not in alignment or level, or does not conform to the lines and grades shown on the Drawings or shows a defective surface, it shall be removed and replaced by the Contractor at his expense unless the Engineer-in-Charge grants permission, in writing, to patch or replace the defective area.

6.21.15 Masonry Short of Height

In case of different thickness of slab in different areas or rooms or for any other reasons, whatsoever if chiseling of masonry is required, the Contractor shall do so at his own cost. Where for any reason whatsoever, the height of the wall is short of ceiling height, the actual height shall be made good with 1:3:6 nominal mix concrete. This concrete shall neither be measured nor be paid under item of concrete but will be paid for under the item of wall masonry. Similarly, where the lintel heights are such that the Contractor has to chisel the masonry or provide cast-in-place concrete to make up the height of the course, no payment will be made for chiseling, but where such cast-in-place concrete is provided, payment for the same will be made at the unit rate of masonry.

6.21.16 Measurement and Payment

Solid Concrete Block Masonry work shall be measured in cubic feet unless otherwise specified. Any extra work over the specified dimensions shall be ignored. Dimensions shall be measured correct to the nearest 0.01 m i.e. 1 cm. Areas shall be calculated to the nearest 0.01 sq. feet and the cubic contents shall be worked out to the nearest 0.01 cubic feet. Block Masonry Work shall be measured separately in the following stages: -

- a) From foundation to floor one level (Plinth level)
- b) Plinth (floor one) level to floor two level
- c) Between two specified floor levels above floor two level

Note: (i) Work in parapet walls, mummy, lift machine room and water tanks constructed on the roof up to 1.2 m height above roof shall be measured together with the corresponding work of the floor next below.

No deductions or additions shall be done and no extra payment made for the following: -

Note: Where minimum area is defined for deduction of an opening, void or both, such areas shall refer only to opening or void within the space measured.

- a) Ends of dissimilar materials (that is, joists, beams, lintels, posts, girders, rafters, purlins, trusses, corbels, steps, etc.); up to 0.1 m² in section;
- b) Opening up to 0.1 m² in area (see Note);
- c) Wall plates, bed plates, and bearing of slabs, and the like, where thickness does not exceed 10 cm and bearing does not extend over the full thickness of wall;
- d) Cement concrete blocks as for hold fasts and holding down bolts;
- e) Iron fixtures, such as wall ties, pipes up to 300 mm diameter and hold fasts for doors and windows; and
- f) Chases of section not exceeding 50 cm in girth.
- g) Bearing portion of drip course, bearing of moulding and cornice.

Note: In calculating area of an opening, any separate lintel or sills shall be included with the size of the opening but end portions of lintel shall be excluded. Extra width of rebated reveals, if any, shall also be excluded. Walls half Block and less shall each be measured separately in square meters stating thickness. Walls beyond half block thickness shall be measured in multiples of half block which shall be deemed to be inclusive of mortar joints. String courses, projecting pilasters, aprons, sills and other projections shall be fully described and measured separately in running meters stating dimensions of each projection. Square or rectangular pillars shall be measured separately in cubic meters in multiple of half brick. Circular pillars shall be measured separately in cubic meters as per actual dimensions. Solid Block Masonry work curved on plan shall be measured like the block work in straight walls and shall include all cutting and wastage of blocks, tapered vertical joints and use of extra mortar, if any. Block

work curved on plan to a mean radius not exceeding six meters shall be measured separately and extra shall be payable over the rates for Block work in straight walls. Nothing extra shall be payable if the mean radius of the Block work curved in plan exceeds six meters. Tapered walls shall be measured net as walls and extra payment shall be allowed for making tapered surface for Block work in walls.

6.21.16.1 Composite Rate

The measurement and payment for the items of the work of Solid Cement Concrete Block Masonry hereof shall be made corresponding to the applicable CSR items as provided in Contract Agreement and shall constitute full compensation, for procurement, transportation, performance in all respects and completion of work as specified including the site clearance as approved by the Engineer-in-Charge. Furthermore, the rate shall include the cost of materials and labour required for all the operations described above except the vertical reinforcement and its encasement in cement mortar or cement concrete. The rate shall also include the following:

- a) Raking out joints or finishing joints flush as the work proceeds;
- b) Preparing tops of existing walls and the like for raising further brick work.
- c) Rough cutting and waste for forming gables, splays at eaves and the like.
- d) Leaving holes for pipes up to 150 mm dia. and encasing hold fasts etc.
- e) Rough cutting and waste for block work curved in plan and for backing to stone or other types of facing.
- f) Embedding in ends of beams, joists, slabs, lintels, sills, trusses etc.
- g) Bedding wall plates, lintels, sills, roof tiles, corrugated sheets, etc. in or on walls if not covered in respective items and
- h) Leaving chases of section not exceeding 50 cm in girth or 350 sq. cm in cross-section.
- i) Cut brick corners, splays reveal, cavity walls, block works curved on plan to a mean radius exceeding six meters.

6.21.16.2 Labor Rate

The measurement and payment for the items of the work of Cement Concrete Block Masonry hereof shall be made corresponding to applicable CSR item as provided in Contract Agreement and shall constitute full compensation for procurement transportation, performance in all respects and completion of work as specified including site clearance, as approved by the Engineer-in-Charge except the cost of materials to be provided by Department at designated location as defined in the Contract Agreement.

6.22 Cement Concrete Hollow Block Masonry

6.22.1 Scope

The work under this section of the specifications consists of furnishing all plant, labour, equipment, appliances and materials and performing all operations in any floor and at any height in connection with the supply and installation of ordinary cement concrete Hollow block masonry work including wall ties, anchors, damp-proof courses, complete in strict accordance with this section of the Specifications and applicable drawings, and subject to the terms and conditions of the Contract.

6.22.2 Materials

6.22.2.1 For Block

Cement, aggregates and water for concrete blocks shall conform to the requirements.

6.22.2.2 For Mortar

The cement and sand mortar for concrete block masonry shall specified.

1. Sand

Sand for mortar shall comply with the requirements for BS-1200. It shall be graded in accordance with the following table and the various sizes of particles shall be uniformly distributed. Sand that has been in contact with seawater shall not be used unless it has been thoroughly washed to the satisfaction of the Engineer-in-Charge.

Sieve Size Number	Percent Passing by Weight	
	Min.	Max.
#4	100	Not Applicable
#8	95	100
#16	70	100
#30	40	75
#50	10	35
#100	2	15
#200	0	0

Table 29, Grading Requirements (Chapter 6)

2. Cement

Cement shall be Ordinary Portland Cement conforming to BS-12.

3. Water

Water shall be clean and free from any harmful impurity. Where the quality of the water is doubtful, it shall be tested in accordance with BS- 3148. The water shall comply with the provision 6.21.2.2(3).

4. Additives

Additives where used, shall be proprietary products used in the proportions and manner recommended by the manufacturer. The additives shall in no way adversely affect the mortar

strength or contain chemicals, which may be harmful to other building materials. To add gypsum to cement is strictly forbidden.

5. Mortars and Grout

Materials for mortar, sand and binding agent and water, shall be mixed by volume or by weight as specified for at least 3 minutes with the minimum amount of water to produce a correctly mixed mortar or grout of workable consistency in a mechanical batch mixer. For small jobs, hand mixing may be permitted, the ingredients being mixed with sufficient water to produce a correctly mixed workable mortar. Mortar shall be as strong, but no stronger than the materials it bonds together. Mortars shall be mixed in batches, which can be used within a period before the setting process commences. Once a mix begins drying off, it shall be rejected. No ingredients shall be added to it once the setting process has begun.

6.22.3 Concrete Hollow Making

The Hollow blocks shall be factory manufactured/fabricated and be machine moulded. The block making machines shall be of the standard approved by the Engineer-in-Charge. They shall be operated according to the instructions laid down by the manufacturers. The contractor shall submit samples/literature of various manufacturers for Engineer-in-Charge's approval. The contractor should note that only blocks supplied by the approved manufacturer(s) shall be allowed to be used in the work. The blocks shall be continuously water cured by sprinkling water for a minimum of 10 days and covered between sprinkling operations with 4 mils thick polyethylene sheeting. After 10 days water curing period the blocks shall be air-dried. Under no circumstance's blocks will be used in the work until they are completely dry. During curing period no surfaces of the block will be allowed to dry. Cured concrete blocks shall be stored off the ground, stacked on level platforms which allow air circulation under stacked units. Units shall be covered and protected against wetting. Care shall be exercised in the handling of all concrete blocks. No damaged blocks shall be used in the work. The hollow blocks shall be manufactured as per pattern shown on the drawing. These block units shall be provided by the Contractor for use where required in building structures from approved type of materials. Units shall have uniformly fine smooth surfaces of uniform colour. These shall be free of any honey combing or other imperfections or deformations, all edges true and straight, and at right angles with each other and without any chipped or otherwise broken edges. The blocks cast on different dates shall be stacked separately and must be labelled showing the date on which they were cast. Reinforced cement concrete hollow block masonry shall be provided where shown on the drawings. Hollow block manufactured by moulding machine shall have well-formed cavities, sharp and well-defined edges and corners, smooth surfaces without any imperfections or deformations.

6.22.4 Properties of Blocks

All blocks shall be of the size and shape required to complete the work shown in the Drawings or as instructed by the Engineer-in-Charge. The cement, sand and coarse aggregate shall be volume batched and their proportion may be adjusted so as to provide the concrete of the required strength when tested and shall be mixed in a concrete mixer in accordance with the provisions Plain and Reinforced Concrete. All blocks shall comply with ASTM C-55-03 edition. The compressive strength of various Hollow blocks shall be as follows:

Sr. #	Type of Concrete Masonry	Compressive Strength (Psi)		Location
		Average of 3 Units	Individual Unit	
1	(ASTM-C-90-85)	700	600	Not exposed to moisture

				& weather
--	--	--	--	-----------

Table 30, Properties of Hollow Blocks (Chapter 6)

Normally 1:3:6 concrete mix should meet the above strength requirement. The specific gravity should be between 2.3 to 2.4. The proportion shall however be confirmed by contractor by trial mix and approved by Engineer-in-Charge for actual site conditions. The Contractor shall provide test certificates providing the average minimum crushing strength of the blocks prior to the commencement of the construction. Further test certificates shall be provided as required by the Engineer-in-Charge to ensure that all batches of blocks have the minimum specified crushing strength. A laboratory approved by the Engineer-in-Charge shall carry out the test. Evidence shall be produced that the block manufacturer has an efficient method of quality control. The Engineer in- Charge will require to test samples of blocks periodically and the Contractor shall make necessary arrangements accordingly. The method of sampling for all tests shall be in accordance with ASTM standards referred in Section 9.4.3.

6.22.5 Suction Rate

The Contractor shall, at his own cost, satisfy the Engineer-in-Charge that the suction rate of the block when determined in accordance with Appendix "A" of BS 3921 does not exceed 20 g/dm²/ min. or that the Contractor is able to adjust it so that it does not exceed this value on site.

6.22.6 Soluble Salt Content

For exposed blockwork, the contents by weight percent of soluble sulphate, calcium, magnesium, potassium and sodium radicals, shall not exceed 0.30, 0.10, 0.30, 0.03 and 0.03, percent respectively when ascertained in accordance with BS 3921, at the cost of the Contractor.

6.22.7 Reinforcing and Anchors of Block Masonry

Unless otherwise stated reinforcing and anchors shall conform to under-mentioned sizes: Joint reinforcing shall be 1.32mm (0.05-inch) diameter mild steel wire mesh design, galvanized after fabrication. Steel wire woven into 12mm mesh 75mm wide. Reinforcing bar anchors shall be 25 mm dia. deformed bar minimum 10 inch long. Two 6mm dia bar shall be provided at every fourth course for anchoring of block masonry to columns. Two 10 mm bars at every fourth horizontal course shall be provided for anchoring masonry walls to plinth beam/floor beam, as shown on the drawings. Dovetail anchors and slots (if used as an alternate anchorage) shall be not less than 18-gauge galvanized steel.

6.22.8 Erection

Blocks shall be laid true to line, level and laid in accurately spaced courses in stretcher bond with vertical joints of each course located at centre of units in alternate courses below. Vertical joints shall be buttered in the entire height of blocks. Each course shall be bonded at corners and at intersections of walls and shall be properly bonded. Courses of block shall be kept plumb throughout and corner reveals shall be true and in plumb. Standard width of mortar joints for both horizontal and vertical joints shall be 10mm (maximum). Mortar joints in walls shall have full mortar coverage on vertical and horizontal faces between the blocks. Mortar joints on wall including struck joints, shall be thoroughly compacted and pressed tight against the edges of the blocks with proper tools. Blocks terminating against soffits of beam or slab construction shall be wedged tight with wedges and the joints shall be packed solidly with mortar between the top of the block and the bottom of slab or beam. Control expansion joints shall be kept free from mortar or other debris. Unless otherwise shown on the drawings or

specified by the Engineer-in-Charge, the spaces around doorframes and other material or built in items shall be solidly filled with mortar. Spaces around the door and window holdfasts shall be filled in with 1:3:6 concrete. Work required to be built in with masonry including doorframe anchors, wall plugs, and dovetail anchors and accessories shall be built in as the erection progresses. The block work shall be carried up in a uniform manner and no portion shall be carried more than one meter above the adjoining one at any time. All masonry shall be kept strictly true and square and the whole properly bonded together and levelled round each floor. Sleeves, Chases, holes, sinking and mortices for other trades shall be correctly located and formed to the sizes as required by the relevant trades. Chiseling of completed walls or the formation of holes shall only be carried out as per design drawings with the approval of the Engineer-in-Charge. Walls of blocks indicated, as being non-load bearing shall be constructed on the in situ concrete floor slab unit after the floor formwork is struck and the concrete has obtained sufficient strength to support their-weight. Tothing into load-bearing walls shall not be permitted. All bolts, anchors, ties, pipe sleeves, flushing metal attachments, lintels and the like required to be built into the work shall be correctly inserted and executed as the work proceeds. Walls or partitions abutting concrete columns or walls shall be securely anchored and tied with metal anchors or ties at not more than 450mm vertical centers. Wall ties cast in with concrete shall be bent down after the removal of formwork and shall be securely jointed into the mortar beds of walling. Care shall be taken during construction of cavity walls so as to avoid the filling up of cavity with mortar. G.I. flashing and weep holes shall be provided wherever specified on the drawings or as per the instructions of the Engineer-in-Charge. Weep holes will be formed by oiled rods, removed after the mortar is set, at specified locations.

6.22.9 Scaffolding

Contractor shall provide safe scaffolding of adequate strength for use of workmen at all levels and heights at his own expense. Scaffolding which is unsafe in the opinion of the Engineer in Charge shall not be used until it has been strengthened and made safe for use of workmen. Cost of scaffolding etc. shall be included by the Contractor in the unit rate for masonry items. Damage to masonry from scaffolding or from any other object shall be repaired by the Contractor at his own cost.

6.22.10 Jointing

Jointing is the forming of joints as work proceeds. Joints shall be as follows:

1. Exterior exposed joints shall be tightly formed to a weather joint with the point of the trowel.
2. Interior exposed joints shall be tightly formed to a concave joint.
3. Joints which are subsequently covered with plaster or other finish materials shall be struck flush.

6.22.11 Tolerances

All block work shall be erected plumb and true to line and level with the maximum variation in any storey height or any length of wall being one mm in one meter. The maximum tolerance in the length, height or width of any single masonry unit shall be ± 3 mm.

6.22.12 Damp Proof Course

Damp-proof course shall be laid on an even mortar bed, free from projections, which may puncture the material. Where the damp-proof course is to be stepped, only flexible membrane shall be used. All damp-proof course, unless otherwise specified, shall consist of 1:2:4 cement

concrete 50mm thick, mixed with 2.5 kg of pudlo per bag of cement or other approved quality water proofing compound as per manufacturer's specifications and shall be laid at required levels as per drawings and instructions of the Engineer-in-Charge. The D.P.C shall be tamped consolidated, levelled, edges and corners made to the requirements of concerned drawings including finishing and curing complete.

6.22.13 Reinforced Hollow Block Masonry

Where specified on the Drawings, reinforced hollow block masonry shall be provided. Horizontal and vertical reinforcement shall be cold worked deformed bar. Two bars of (8mm) diameter shall be provided at every third horizontal course at 600 mm centers, while the vertical reinforcement shall be two bars of (12mm) diameter at 800mm centers. Bars shall be anchored and held firmly vertical in respective beams and columns in the manner shown in shop Drawings. The reinforced hollow part of the block wall shall be solidly filled with Class 'D' concrete at intervals of one-meter maximum height as the laying of block masonry work proceeds. The filled concrete shall be consolidated thoroughly by rodding to avoid formation of voids. Contractor shall submit shop drawings of anchoring and placing of reinforcement in hollow block masonry for approval of the Engineer-in-Charge.

6.22.14 Curing and Repairs

All block masonry shall be water cured and shall be kept wet for at least seven days, by an approved method, which will keep all surfaces to be cured continuously wet. Water used for curing shall meet the requirements of the specifications for water used in the manufacture of blocks. If, after the completion of any block masonry, the work is not in alignment or level, or does not, conform to the lines and grades shown on the Drawings or shows a defective surface, it shall be removed and replaced by the Contractor at his expense unless the Engineer-in-Charge grants permission, in writing, to patch or replace the defective area.

6.22.15 Masonry Short of Height

In case of different thickness of slab in different areas or rooms or for any other reasons, whatsoever if chiseling of masonry is required, the Contractor shall do so at his own cost. Where for any reason whatsoever, the height of the wall is short of ceiling height, the actual height shall be made good with 1:3:6 nominal mix concrete. This concrete shall neither be measured nor be paid under item of concrete but will be paid for under the item of wall masonry. Similarly, where the lintel heights are such that the Contractor has to chisel the masonry or provide cast-in-place concrete to make up the height of the course, no payment will be made for chiseling, but where such cast-in-place concrete is provided, payment for the same will be made at the unit rate of masonry.

6.22.16 Measurement and Payment

Hollow Concrete Block Masonry work shall be measured in cubic meters unless otherwise specified. Any extra work over the specified dimensions shall be ignored. Dimensions shall be measured correct to the nearest 0.01 m i.e. 1 cm. Areas shall be calculated to the nearest 0.01 sq. meter and the cubic contents shall be worked out to the nearest 0.01 cubic meters. Block Masonry Work shall be measured separately in the following stages: -

- a) From foundation to floor one level (Plinth level)
- b) Plinth (floor one) level to floor two level
- c) Between two specified floor levels above floor two level

Note: Work in parapet walls, mummy, lift machine room and water tanks constructed on the roof up to 1.2 m height above roof shall be measured together with the corresponding work of the floor next below. No deductions or additions shall be done and no extra payment made for the following: -

Note: Where minimum area is defined for deduction of an opening, void or both, such areas shall refer only to opening or void within the space measured.

- a) Ends of dissimilar materials (that is, joists, beams, lintels, posts, girders, rafters, purlins, trusses, corbels, steps, etc.); up to 0.1 m² in section;
- b) Opening up to 0.1 m² in area (see Note);
- c) Wall plates, bed plates, and bearing of slabs, and the like, where thickness does not exceed 10 cm and bearing does not extend over the full thickness of wall;
- d) Cement concrete blocks as for hold fasts and holding down bolts;
- e) Iron fixtures, such as wall ties, pipes up to 300 mm diameter and hold fasts for doors and windows; and
- f) Chases of section not exceeding 50 cm in girth.
- g) Bearing portion of drip course, bearing of moulding and cornice.

Note: In calculating area of an opening, any separate lintel or sills shall be included with the size of the opening but end portions of lintel shall be excluded. Extra width of rebated reveals, if any, shall also be excluded.

Walls half Block and less shall each be measured separately in square meters stating thickness. Walls beyond half block thickness shall be measured in multiples of half block which shall be deemed to be inclusive of mortar joints. String courses, projecting pilasters, aprons, sills and other projections shall be fully described and measured separately in running meters stating dimensions of each projection. Square or rectangular pillars shall be measured separately in cubic meters in multiple of half brick. Circular pillars shall be measured separately in cubic meters as per actual dimensions. Hollow Block Masonry work curved on plan shall be measured like the block work in straight walls and shall include all cutting and wastage of blocks, tapered vertical joints and use of extra mortar, if any. Block work curved on plan to a mean radius not exceeding six meters shall be measured separately and extra shall be payable over the rates for Block work in straight walls. Nothing extra shall be payable if the mean radius of the Block work curved in plan exceeds six meters. Tapered walls shall be measured net as walls and extra payment shall be allowed for making tapered surface for Block work in walls.

6.22.16.1 Composite Rate

The measurement and payment for the items of the work of Cement Concrete Block Masonry hereof shall be made corresponding to the applicable CSR items as provided in Contract Agreement and shall constitute full compensation, for procurement, transportation, performance in all respects and completion of work as specified including the site clearance as approved by the Engineer-in-Charge. The measurement and payment for the items of the work of Hollow Cement Concrete Block Masonry hereof shall be made corresponding to the applicable CSR items as provided in Contract Agreement and shall constitute full compensation, for procurement, transportation, performance in all respects and completion of work as specified including the site clearance as approved by the Engineer-in-Charge. Furthermore, the rate shall include the cost of materials and labour required for all the operations described above except the vertical reinforcement and its encasement in cement mortar or cement concrete. The rate shall also include the following: -

- a) Raking out joints or finishing joints flush as the work proceeds;
- b) Preparing tops of existing walls and the like for raising further brick work.

- c) Rough cutting and waste for forming gables, splays at eaves and the like.
- d) Leaving holes for pipes up to 150 mm dia. and encasing hold fasts etc.
- e) Rough cutting and waste for block work curved in plan and for backing to stone or other types of facing.
- f) Embedding in ends of beams, joists, slabs, lintels, sills, trusses etc.
- g) Bedding wall plates, lintels, sills, roof tiles, corrugated sheets, etc. in or on walls if not covered in respective items and
- h) Leaving chases of section not exceeding 50 cm in girth or 350 sq. cm in cross-section.
- i) Cut brick corners, splays reveal, cavity walls, block works curved on plan to a mean radius exceeding six meters.

6.22.16.2 Labor Rate

The measurement and payment for the items of the work of Cement Concrete Block Masonry hereof shall be made corresponding to applicable CSR item as provided in Contract Agreement and shall constitute full compensation for procurement transportation, performance in all respects and completion of work as specified including site clearance, as approved by the Engineer-in-Charge except the cost of materials to be provided by Department at designated location as defined in the Contract Agreement.

6.23 Ready Mix Concrete

6.23.1 Description

This specification covers ready-mixed concrete manufactured and delivered to the site in a freshly mixed and unhardened state as hereinafter specified and as per the requirements specified by Engineer in Charge.

Prior to purchasing the ready-mix concrete or setting up the Batching plant, plant should be approved by the Engineer in Charge so that the required quality of concrete can be obtained. Before selection of plant matters considered should include transportation time to sites, unloading time, number of transportation vehicles, condition of manufacturing equipment and production capacity of plant.

6.23.2 Materials Requirements, Storage and Handling

Overall materials should fulfill the requirements of heading 6.1.4 of these specifications and requirement of ASTM C-94 and ACI – 304R.

6.23.2.1 Cement

Separate storage for different types and grades of cement shall be provided. Containers may be used to store cements of different types provided these are emptied before loading anew cement. Bins or silos shall be weatherproof and permit free flow and efficient discharge of the cement. Each silo or compartment of a silo shall be completely separate and fitted with a filter or alternative method of dust control. Each filter or dust control system shall be of sufficient size to allow delivery of cement to be maintained at a specified pressure, and shall be properly maintained to prevent undue emission of cement dust and prevent interference with weighing accuracy by buildup of pressure. Cement shall be stored and stacked in bags and shall be kept free from the possibility of any dampness or moisture coming in contact with them and where cement can be stored and retrieved without undue damage to the bags. The bags are to be protected from becoming damp either from the ground or the weather. The cement is to be used in the order it is delivered. In case, the cement remains in storage for more than 3 months, the cement shall be retested before use and shall be rejected if it fails to conform to the requirements.

6.23.2.2 Aggregate

Stockpiles shall be free draining and arranged to avoid contamination and to prevent intermingling with adjacent material. Handling procedures for loading and unloading aggregates shall be such as to reduce segregation to a minimum. Provision shall be made for separate storage for each nominal size and type of aggregate and the method of loading of storage bins shall be such as to prevent intermingling of different sizes and types. Fine aggregates shall be stacked in a place where loss due to the effect of wind is minimum.

6.23.2.3 Water

An adequate supply shall be provided and when stored on the plant such storage facilities shall be designed to minimize the risks of contamination.

6.23.2.4 Mineral Admixture

Suitable separate arrangement for storage of pulverized fuel ash, silica fume, metakaolin, rice husk ash, ground granulated blast furnace slag such as for cement, shall be provided, in the plants utilizing these materials.

6.23.2.5 Chemical Admixture

Tanks or drums containing liquid admixtures shall be clearly Labeled for identification purposes and stored in such a way to avoid damage, contamination or the effects of prolonged exposure to sunlight (if applicable). Agitation shall be provided for liquid admixtures, which are not stable solutions.

6.23.3 Construction Requirement

6.23.3.1 Batching Plant

6.23.3.1.1 Plant Mechanical Equipment

1. Bins or Silos

A bin or silo shall consist of a suitable container for storing aggregates or cement and cementitious materials and, in the case of the latter, protecting it from moisture. Bins or silos shall be designed structurally in accordance with the current specifications of the American Institute of Steel Construction.

2. Conveying Equipment

All conveyor capacities, as shown on the rating plate, shall be based on the equipment being uniformly and continuously fed.

a. Belt Conveyors for Aggregates

Belt Conveyors for Aggregates shall conform to the current Standards of the Conveyor Equipment Manufacturers Association. Rated capacities, as shown on the rating plate, shall be stated in metric tons per hour (tons per hour) assuming the material to weigh 1600 kg/m³ (99.9 lb./ft³).

b. Bucket Elevators for Aggregates

Bucket Elevators for Aggregates shall have their rated capacities, as shown on the rating plate, stated in terms of tons per hour (metric tons/hr.) computed by assuming that the buckets are filled to 75 percent of their actual volume capacity with material weighing 1600 kg/m³ (99.9 lb./ft³).

c. Bucket Elevators for Cement

Bucket Elevators for Cement shall have their rated capacities, as shown on the rating plate, stated in terms of ft³/hr. (m³/hr.) computed on the assumption that the buckets are filled to 100 percent of their water level capacity.

d. Other Conveyors for Cement

Other Conveyors for Cement such as screw conveyors, slides and pumps shall have their rated capacities as shown on the rating plate stated in terms of cubic meters per hour based on the volumetric capacity rating by the manufacturer of the conveyor.

3. Batching Equipment

Batching Equipment shall provide that: -

- cement or cementitious materials shall be batched by weight;
- aggregates shall be batched by weight;
- water shall be batched by weight or volume;
- powdered admixtures shall be batched by weight; and
- liquid admixtures shall be batched by weight or volume.

6.23.3.1.2 Plant Control Systems

1. Batching Controls and Systems

Batching controls shall be that part of the batching equipment that shall provide the means for controlling the batching device for an individual material. They shall be mechanical, hydraulic, pneumatic, electrical, etc. or a combination of these means. A batching system shall be a combination of batching controls necessary to proportion the ingredients for concrete. A batching system may consist of controls for batching cement and aggregate only, if the mixing water is not added at the batching plant. Volumetric admixture batching controls shall be included in the scope of these Standards only when they shall be a part of a batching system. Batching controls or systems shall be so located with respect to the batching equipment being controlled that visual monitoring for accuracy, calibration of controls and manual batching can be accomplished. If manual batching is not normally done, monitoring devices shall be sufficiently accurate to detect an error equal to the specified tolerance when a batch equal to the rated size of the batcher is batched. Where batching controls or systems are remotely located with respect to the batching equipment and manual batching is not normally done, monitoring devices shall be sufficiently accurate to detect an error equal to the specified tolerance when a batch equal to the rated size of the batcher is batched. Where batching controls or systems are remotely located with respect to the batching equipment, follower scales or other remote monitoring devices may be used for manual batching if they repeat the reading of the master scale within $\pm 0.2\%$ of scale capacity.

a. Manual Controls

Manual controls shall not be furnished with a rating plate. Manual control shall exist when the batching devices are actuated manually with the accuracy of the batching operation being dependent on the operator's visual observation of a scale or volumetric indicator. The batching devices shall be actuated by hand or by pneumatic, hydraulic, or electrical power assists.

b. Semi-Automatic Batcher Controls

Semi-Automatic Batcher Controls shall be furnished with rating plates only when ingredients are weighed. This rating plate shall be used only for an individual batcher control. When actuated by one or more starting mechanisms, a semi-automatic batcher control shall start the weighing operation of each material and stop automatically when the designated weight of each material has been reached. No interlocks shall be required.

c. Semi-Automatic Interlocked Batcher Controls

Semi-Automatic Interlocked Batcher Controls shall be furnished with rating plates only when ingredients are weighed. This rating plate shall be used only for an individual batcher control. When actuated by one or more starting mechanisms, a semi-automatic interlocked batcher

control shall start the weighing operation of each material and stop automatically when the designated weight of each material has been reached, interlocked in such a manner that the discharge device cannot be actuated until the indicated material is within the applicable tolerances.

d. Automatic Batcher Controls

Automatic Batcher Controls shall be furnished with rating plates only when ingredients are weighed. This rating plate shall be used only for an individual batcher control. When actuated by a single starting signal, an automatic batcher control shall start the weighing operation of each material and stop automatically when the designated weight of each material has been reached, interlocked in such a manner that: -

- The charging device shall not be actuated until the scale has returned to zero balance within $\pm 0.3\%$ of the scale capacity;
- The charging device shall not be actuated if the discharge device is open;
- The discharge device shall not be actuated if the charging device is open; and
- The discharge device shall not be actuated until the indicated material is within the applicable tolerances.

A tare compensated control is one that treats the start of the weighing of each ingredient as zero. For cumulative batchers with tare compensated controls, interlocked sequential controls shall be provided, and the applicable tolerances shall apply to the required weight of each individual material. For cumulative batchers without tare compensated controls, interlocked sequential controls shall be provided, and the applicable tolerances shall apply to the required cumulative weight of material as batched.

2. Batching Recorders, General

A batching recorder may be either graphic or digital as described in the following paragraphs. All batching recorders shall produce a record of the batch weights or volume of each material requiring recordation, a batch identification or a batch count, day, month, year, time of day to the nearest minute and shall register empty balance. Any automatically produced permanent record, including the above minimum information, shall be considered an acceptable batching record. Target weights, simulated weights or any other weights other than actual batch weights shall be clearly identified as to their representation.

6.23.3.1.3 Plant Mixer Equipment

1. Specifications

a. Size and Mixing Capacity

The size of a mixer shall be its rated maximum mixing capacity. The rated maximum mixing capacity is the maximum volume of concrete that can be held and mixed properly when the mixer is operated in its normal mixing position, based on the slump range and maximum aggregate size. However, the manufacturer shall provide a data plate on the mixer showing the same or a lower capacity, in which case such limitations shall govern.

b. Computed Interior Volume

The computed interior volume of the mixing compartment shall be not less than the minimum volume prescribed for its size and type.

c. Water Level Capacity

The water level capacity of the mixing compartment (below a horizontal plane through the lowest edge of the lowest opening that is open while mixing) when the mixer is operating in its normal mixing position shall be not less than 70 percent of the rated maximum mixing capacity prescribed for its size and type.

d. Mixing Speed

A data plate indicating mixing speed in rpm shall be attached to the mixer. The mixing speed shall be as designated by the manufacturer as best suited for the maximum rated capacity.

2. Definitions**a. Concrete Plant Mixer**

A machine used to combine cementitious materials, water, aggregates and other ingredients to produce concrete in a batch, and usually operated in a fixed plant location while mixing concrete.

b. Non-Tilting Mixer

A rotating drum mixer that charges, mixes and discharges with the drum axis horizontal.

c. Tilting Mixer

A rotating drum mixer that discharges by tilting the drum about a fixed or movable horizontal axis at right angles to the drum axis. The drum axis may be horizontal or inclined from the horizontal while charging and mixing.

d. Vertical Shaft Mixer

A mixer with an essentially level floor and cylindrical or annular mixing compartment, with one or more vertical rotating shafts to which blades or paddles are attached. The mixing compartment may be stationary or rotate about a vertical axis.

e. Horizontal Shaft Mixer

A mixer with a stationary or rotatable cylindrical mixing compartment with the axis of the cylinder horizontal and one or more rotating horizontal shafts to which mixing blades are attached.

6.23.4.3.2 Mixing

As per ASTM C-94 Ready-mixed concrete shall be mixed and delivered to the point designated by the Engineer in Charge by means of one of the following combinations of operations:

1. Central Mixed Concrete
2. Shrink Mixed Concrete
3. Truck Mixed Concrete

1. Central Mixed Concrete:

Central-mix plants are sometimes referred to as wet batch or pre-mix plants. Concrete that is mixed completely in a stationary mixer and transported to the point of delivery either in a truck agitator, or a truck mixer operating at agitating speed, or in non-agitating equipment approved by the Engineer in Charge and meeting the requirements of these specifications shall conform to the following: -

- The mixing time shall be counted from the time all the solid materials are in the drum.
- The batch shall be so charged into the mixer that some water will enter in advance of the cement and aggregate, and all water shall be in the drum by the end of the first one fourth of the specified mixing time.

2. Shrink Mixed Concrete:

The concrete is partially mixed in the plant mixer and then balance mixing is done in the truck mounted drum mixer during transit time. Concrete that is first partially mixed in a stationary mixer, and then mixed completely in a truck mixer, shall conform to the following: -

- The time of partial mixing shall be the minimum required to intermingle the ingredients, after transfer to a truck mixer, the amount of mixing at the designated mixing speed will be that necessary to meet the requirements for uniformity of concrete as per ASTM C -94.
- Tests to confirm such performance shall be made in accordance with ASTM C-94. Additional turning of the mixer, if any, shall be at a designated agitating speed.

3. Truck / Transit Mixed Concrete:

It is also called dry batched concrete because all the basic ingredients including water are charged directly into the truck mixer. The mixer drum is revolved fast at charging speed during the loading of the material and after that it continues rotating at a normal agitating speed.

Concrete is completely mixed in a truck mixer, 70-100 revolutions at the mixing speed designated by the manufacturer to produce the uniformity of concrete indicated as per ASTM C-94. Concrete uniformity tests shall be made in accordance with standards and these specifications and if requirements for uniformity of concrete indicated in ASTM -C-94 are not met with 100 revolutions of mixing, after all ingredients including water are in the drum, that mixer shall not be used until the condition is corrected, except as per ASTM C-94. When satisfactory performance is found in one truck mixer, the performance of mixers of substantially the same design and condition of blades are permitted to be regarded as satisfactory. Additional revolutions of the mixer beyond the number found to produce the required uniformity of concrete shall be at a designated agitating speed.

6.23.3.3 Transporting and Handling of Concrete

6.23.3.3.1 General

As per ACI – 304R; Concrete can be transported by a variety of methods and equipment, such as pipeline, hose, conveyor belts, truck mixers, open-top truck bodies with and without agitators, or buckets hauled by truck or railroad car. The method of transportation should efficiently deliver the concrete to the point of placement without losing mortar or significantly altering the concrete's desired properties associated with w/cm, slump, air content, and homogeneity. Various conditions should be considered when selecting a method of

transportation, such as: mixture ingredients and proportions; type and accessibility of placement; required delivery capacity; location of batch plant; and weather conditions. These conditions can dictate the type of transportation best suited for economically obtaining quality in-place concrete. During transporting concrete following requirements should be fulfilled: -

- Concrete shall be discharged from the truck mixer within 90 mins however this period can be increased by adding retarding admixture of approved quality.

6.23.3.3.2 Revolving Drum

In this method, the truck mixer should serve as an agitating transportation unit. The drum shall be rotated at charging speed during loading and shall be reduced to agitating speed or stopped after loading is complete. The elapsed time before discharging the concrete should be the same as for truck mixing and the volume carried should be increased to 80% of the drum capacity (ASTM C 94).

6.23.3.3.3 Truck Body with or without an agitator

Units used in this form of transportation shall consist of an open-top body mounted on a truck, although bottom-dump trucks have been used successfully. The metal body should have smooth, streamlined contact surfaces and is usually designed for discharge of the concrete at the rear when the body is tilted. A discharge gate and vibrators mounted on the body should be provided at the point of discharge for control of flow. An agitator, if the truck body is equipped with one, aids in the discharge and ribbon-blends the concrete as it is unloaded. Water should never be added to concrete in the truck body because no mixing is performed by the agitator. Use of protective covers for truck bodies during periods of inclement weather, proper cleaning of all contact surfaces, and smooth haul roads contribute significantly to the quality and operational efficiency of this form of transportation. The maximum delivery time specified is usually 30 to 45 min, although weather conditions can require shorter or permit longer times. Trucks that have to operate on muddy haul roads should not be allowed to discharge directly on the grade or drive through the discharged pile of concrete.

6.23.3.3.4 Concrete Buckets on Truck or railroad cars

This is a common method of transporting concrete from the batch plant to a location close to the placement area of a mass concrete placement. A crane then lifts the bucket to the final point of placement. Occasionally, transfer cars operating on railroad tracks should be used to transport the concrete from the batch plant to buckets operating from cableways. Discharge of the concrete from the transfer cars into the bucket, which can be from the bottom or by some form of tilting, should be closely controlled to prevent segregation. Delivery time for bucket transportation should be the same as for other non-agitating units—usually 30 to 45 min.

6.23.3.3.5 Other Methods

If necessary, helicopter deliveries shall have been used in difficult-to-reach areas where other transporting equipment could not be used. This system should usually employ one of the methods described previously to transport the concrete to the helicopter, which then lifts the concrete in a lightweight bucket to the placement area.

6.23.4 Measurements & Payment

Ready mix concrete should be measure in cubic meter or cubic feet and paid accordingly.

6.24 Shotcrete

6.24.1 Description

This Standard Specification describes the requirements for materials, proportioning, and application of shotcrete.

6.24.3 Material Requirement

6.24.3.1 Cement

Portland cement shall conform to ASTM C 150. Type I. For shotcrete, ordinary Portland cement is generally used. In cases where the shotcrete is exposed to a sulfate environment (e.g. in hot spring areas) or to an environment affected by salt as in an ocean, Portland blast furnace cement type B is used.

6.24.3.2 Aggregate

For shotcrete aggregates inducing no alkali-silica reaction should be used as a standard practice. The total alkali content of concrete generally exceeds 3.0 kg/m³. Aggregate shall conform to the following standards: -

- Normal weight aggregate: ASTM C 33. Aggregate not meeting ASTM C 33 may be used provided preconstruction tests demonstrate the shotcrete can meet specified requirements.
- Lightweight aggregate: ASTM C 330

In cases where aggregates inducing no alkali-silica reaction are unavailable, blended Portland cement should be used.

6.24.3.3 Reinforcement

Reinforcement shall conform to the following standards: -

- Deformed steel reinforcement: ASTM A 615
- Welded wire fabric: ASTM A 185
- Steel fibers: ASTM A 820 and C 1116

Shotcrete using steel fibers should be used in sections subjected to structurally high stress such as tunnel portals, intersections of tunnels and enlarged sections; or in sections under poor geological conditions that are subjected to great earth pressure such as Emit fracture zones and expansive ground, mainly for improving toughness. Increasing the flexural strength, tensile strength, shear strength and flexural toughness of shotcrete is expected to reduce shotcrete thickness and prevent shotcrete from spoiling. In some cases, the designated mechanical properties and toughness may not be available for shotcrete even if the designated percentage of steel fibers is attained. Steel fibers should therefore be of a shape that prevents deformation during mixing or shotcreting and causes no clogging of the hose.

When using steel fibers in shotcrete, the pumping load of concrete., quantity of steel fibers in the material that rebounds, orientation and deformation of steel fibers in concrete and wear of shotcrete machine should be fully considered.

6.24.3.4 Admixture and Short fiber

Admixture shall conform to: -

- Water-reducing: ASTM C 1141
- Retarding: ASTM C 1141
- Accelerating: ASTM C 1141
- Air-entraining: ASTM C 1141
- Fly ash and natural pozzolans: ASTM C 618
- Ground granulated blast-furnace slag: ASTM C 989
- Silica fume: ASTM C 1240

When using admixtures, it should be verified in advance by conducting testing that the designated quality requirements are met for the concrete. Shotcrete using fine limestone powder as well as that using admixtures has been determined to improve the ease of construction and work and reduce the dust concentration and rebound. Fine limestone powder is sometimes used with other types of admixtures. When using fine limestone powder, it should be verified in advance by conducting testing that the designated quality requirements are met for the concrete.

Chemical admixtures for concrete have been used in an increasing number of cases to reduce the water content of shotcrete, improve resistance to material segregation and obtain designated workability. For slope shotcrete in particular, the designated resistance to freezing and thawing action is frequently demanded. It is therefore necessary to use air-entraining agents, air-entraining water-reducing agents and high-performance air-entraining water-reducing agents.

6.24.3.5 Curing Material

Curing materials that cause stains on architectural finishes shall not be used. Curing material shall conform to: -

- Sheet materials: ASTM C 171
- Curing compounds: ASTM C 309, apply twice the coverage (double the application rate) recommended by manufacturers.

6.24.4 Construction Requirements

6.24.4.1 Batching and Mixing

Weight batching shall comply with the accuracy specified in ASTM C 94. Volume batching shall comply with the accuracy specified in ASTM C 685. Volume batching shall be verified once a week by a weight batching check. Use batching and mixing equipment capable of proportioning and mixing the required materials. Shoot dry-mix shotcrete material within 45 min after batching or pre-dampening. This requirement does not include dry, pre-bagged material unless pre-bagged material is pre-dampened. Shoot wet-mix shotcrete material within 90 min after batching.

6.24.4.2 Production

1. General

When producing shotcrete, facilities for storing, measuring and mixing the materials and shotcrete machines shall be selected so as to meet quality requirements for the shotcrete.

2. Production Facilities

- For measuring the volume of materials, equipment with designated measurement accuracy should be used as a standard practice.
- For mixing, mixers with designated mixing capacity should be used as a standard practice. The method for inputting materials and mixing time should be determined so that the designated quality requirements are satisfied.

When using continuous mixers, the measuring equipment for respective materials should be inspected using the materials to be used in the work before the start of construction work. In cases where measuring the mass is difficult when measuring the volume of water to be added in the dry shotcreting system or when measuring the quantity of chemical admixtures applied in the wet shotcreting system, flow meters or other equipment should be used for measurement.

3. Shotcrete Machinery and accessory Equipment

- Shotcrete machines shall be able to uniformly and continuously pump and spray concrete of designated quality.
- Accessory equipment shall be able to help shotcrete machines meet the designated performance requirements.

Shotcrete machines should be able to uniformly and continuously transport materials so that the designated quality of concrete and work efficiency may be secured. When constructing shotcrete, the nozzle is either remote-operated by an automatic shotcrete machine or operated manually. In cases where a wide work area is available and no scaffolding is required, automatic shotcrete machines are should be adopted. In a tunnel cross section of 30 m² or less or when spraying concrete on a slope, concrete is sprayed manually in numerous cases. It should be verified by conducting preliminary tests that the designated quality requirements are met for the concrete. It should be made sure that adequate strength is available at the points of hose connection and attachment Shotcrete machines, without the capacity for pumping materials uniformly and continuously, may fail to provide designated quality and excellent finished surface and deteriorate work efficiency. If the pumping distance or vertical height is increased, pumping becomes difficult and concrete quality is likely to become heterogeneous. A hose length of 100 m or a height of 45 m is therefore specified as a standard. Compressors should be provided with adequate capacity considering the piping resistance and leakage because insufficient volume or pressure of compressed air may cause clogging or production of non-uniform shotcrete. Then. no designated quality may be obtained. Methods of adjustment to secure the designated quantities should be verified in advance by conducting material pumping tests. Compressed air used for pumping contains moisture. When using powder set accelerators. therefore. the moisture in compressed air should be removed using a drier.

6.24.4.3 Surface Preparation

1. **Earth** - Prepare surfaces to line and grade. Do not apply shotcrete to frozen surface. Dampen surface immediately prior to shooting.
2. **Concrete, masonry, and shotcrete** - When bonding is required, remove all deteriorated, loose unsound material or contaminants that may inhibit bonding. Chip areas to be repaired to remove offsets causing abrupt changes in thickness. Taper edges to eliminate square shoulders at the perimeter of a cavity. Surface shall be saturated surface dry immediately prior to shooting.
3. **Structural/reinforcement** - The surface shall be free of deleterious materials that inhibit bonding. For new construction, reinforcement laps shall be separated with a clearance of at least three times the diameter of largest aggregate. Reinforcement shall be secured to prevent movement.
4. **Rock** - Remove loose material, mud or other foreign material that will prevent bonding. Clean surface. Pre-wet surface immediately prior to shooting.
5. **Forms** - Use form-release coating material on removable forms. Secure forms to minimize the effects of vibration. Construct forms to allow escape of placement air and rebound.

6.24.4.4 Applications

1. Placement techniques

Provide a platform that permits nozzleman unobstructed access to the receiving surface. Place shotcrete first in corners, recesses, and other areas where rebound or overspray cannot escape easily. Remove rebound and overspray from previously prepared surfaces prior to shotcrete placement. Place shotcrete with nozzle held approximately perpendicular to the receiving surface. In corners, direct nozzle at approximately 45 deg angle or bisect the corner angle. Apply shotcrete so sags or sloughing do not occur. Discontinue shooting or shield the nozzle stream if wind causes separation of ingredients during shooting. Do not reuse rebound or overspray. Remove laitance from shotcrete surfaces to receive additional shotcrete layers. Surface preparation after final set shall be according to following requirement: -

When bonding is required, remove all deteriorated, loose unsound material or contaminants that may inhibit bonding. Chip areas to be repaired to remove offsets causing abrupt changes in thickness. Taper edges to eliminate square shoulders at the perimeter of a cavity. Surface shall be saturated surface dry immediately prior to shooting.

Do not apply shotcrete on surfaces with standing water or running water. Remove hardened overspray and rebound from adjacent surfaces, including exposed reinforcement.

2. Encasement of reinforcement

Place shotcrete to completely encase reinforcing steel. Encase reinforcement by shooting with sufficient velocity and plasticity so material flows around and behind the reinforcement. Front face of reinforcement shall remain clean during encasement. Place shotcrete to provide the cover over reinforcement required by ACI 301. Minimum slump of wet-mix shotcrete is 1 in.

6.24.4.5 Mechanized Spraying

Mechanized spraying should be used in underground and open pit mining and in civil tunneling and slope stabilization activities.

1. Inspecting for Hazards Prior to Spraying

Before approaching any area where shotcrete is to be applied, the machine should be parked in a safe position and an inspection of the work area should be carried out on foot, the risk of rockfall should be assessed and a safe position within supported ground should be ascertained for the rig to be set up. The surface to be shotcrete should be examined for any remaining misfired explosives (if it has been exposed through recent blasting), loose ground, water seepage and any signs of ground movement. After a thorough inspection and risk assessment, the shotcrete machine can be moved into position.

2. Set up of Machines

Spray machines should be set on level ground and should be chocked to avoid any movement.

3. Spraying Procedure

a. Preparing to Spray

Before any shotcrete is sprayed, the shotcrete machine should be carefully coated with a layer of form oil to assist with cleaning of the machine after spraying. The shotcrete nozzle should be checked for cleanliness and wear. Accelerator lines must also be checked before spraying is commenced. This is done by turning the air valve to the nozzle off, pointing the nozzle to the ground (to stop accelerator flowing down the concrete lines) and slowly turning on the air supply to check for leaks and pressure and then turning on the accelerator. The flow of the accelerator can be checked from a gauge on the pump, or assessed through timing the discharge into a calibration jug. It should be ensured that the dosage rate matches the manufacturer's recommendations for the cement content of the mix. The shotcrete machine's pump and delivery lines must initially be primed using a small amount of slurry. This material should be discharged onto the floor of the excavation and not applied to the surface to be supported. Priming may not be required if the lines are still wet following cleaning from a previous load.

The slump and condition of the shotcrete mix should be assessed by the sprayer as it is initially discharged into the hopper. The slump of the shotcrete should be checked through slump test.

b. Spray Technique

To minimize rebound and maximize compaction, the nozzle must always be kept a distance of one to two meters from the surface being sprayed. The correct nozzle angle is also important and should be as close as perpendicular to the surface as possible. The sprayer must first spray all fissures and faults to ensure that they are filled with shotcrete. All back angles (shadows) and possible areas of rebound accumulation should then be sprayed. Following this, the first layer of shotcrete may be sprayed onto the surface. The operator should start at the lowest point and work forward in a horizontal oscillating pattern to spray an even layer of shotcrete onto the surface.

Shotcrete should be applied in layers of 25mm (especially when being applied overhead) to prevent fallout. Ideally, the operator should wait ten minutes between layers to ensure adequate set of the first layer before applying the second. Most mining applications require shotcrete thickness of between 50mm and 100mm and civil applications commonly require a thickness in excess of 100mm. Methods of thickness control during spraying include using

metal probes of a set length mounted on the end of the shotcrete boom to check the depth of the wet shotcrete and the use of stick on depth indicators which may be applied before spraying commences.

Shotcrete thickness can also be measured by several methods post spraying. The most common method in use is the drilling and measuring of probe holes, though the small number usually drilled combined with the fact that they only provide point data suggest this method is of questionable value. There is also ample evidence that drilled probe holes provide initiation points for cracking of shotcrete. More representative areal data can be obtained through the generation of before and after three dimensional surveys of the areas being sprayed. This has been achieved through the use of laser scanners and more recently has been achieved through photogrammetry. A survey must be taken after hydro scaling and then one after spraying. The two surveys can then be compared and a "thickness map" generated.

If spraying an area where access is required to the area to continue tunnel advance, it is common to spray a "re-entry panel" of shotcrete on an area of wall under supported ground. This panel can be marked with the date and time of spraying and a penetrometer may then be used to check the strength development of the shotcrete without entry into the area sprayed being necessary. All sprayed areas should be barricaded or a sign used to indicate the hazard of wet shotcrete.

6.24.4.6 Curing

Immediately after finishing, cure shotcrete continuously by maintaining in a moist condition for seven days or until specified strength is attained or until succeeding shotcrete layers are placed. Cure by one of the following methods: -

- Ponding or continuous sprinkling
- Covering with an absorptive mat or sand that is kept continuously wet
- Covering with impervious sheet material
- Curing compounds

Natural curing shall be permitted if ambient relative humidity is maintained above 95 percent.

6.24.5 Measurement and Payment

Shotcrete should be measured in units of cubic feet and will be paid accordingly. Payment should be inclusive of labor and material and complete in all respect.

6.25 Mass Concrete

6.25.1 Description

Mass concrete is defined in ACI 116R as “any volume of concrete with dimensions large enough to require that measures be taken to cope with generation of heat from hydration of the cement and attendant volume change to minimize cracking.”

Prior to mass concrete construction, appropriate plans for concrete temperature control, transportation, placement, curing, etc. shall be made so that the effects of thermal crack control measures determined in advance can be achieved.

In controlling thermal cracking during mass concrete construction, various measures for preventing cracking, controlling the position, interval and width of cracks shall be carried out at construction stage in order to satisfy the required function and performance of the structure. In order to control thermal cracking, not only the selection of cement type, materials, admixtures, mix proportions as well as the adjustment of concrete placing temperature, but also the selection of formwork dimension, lift height, joint position, placing time interval, material and fabrication of formwork as well as curing method should be considered thoroughly from production to construction stages. Depending on the structure type, controlling the crack position by crack-inducing joints may be effective in some cases. Regarding these measures in making concrete and construction for controlling and preventing cracking, construction of mass concrete should, in general, be carried out in accordance with Standard Specification: Design in which the requirements on material, mix proportion, production and construction method are described in details based on prior examination related to thermal cracking. Other methods for controlling or preventing thermal cracking such as using pipe cooling for dam concrete or large bridge pier, using expansive concrete or arranging reinforcing bars for crack control can be adopted. However, since these methods lead to cost rise, their technical and economical efficiencies should be evaluated.

Material Requirements	Temperature Monitoring	Temperature Requirements	Thermal Control Plan
Type III Cement shall not be used unless specified by the engineer	Place two sensors at the center of the largest portion of the placement and two sensors no more than 2 in. from center of the nearest exterior surface. The second sensor at each location is for redundancy.	Maximum concrete temperature of placement of 95°F	A thermal control plan (TCP) must be submitted and approved by the project engineer.
Use hydraulic cement with a low heat-of-hydration or use a Portland cement in combination with Class F fly ash and/or slag cement	Temperatures should be recorded no less often than every 12 hours	Maximum concrete temperature of 160°F	

		Maximum temperature difference of 35°F	
--	--	----------------------------------------	--

Table 31, Mass concrete requirements of ACI 301 (2016) (Chapter 6)

6.25.2 Material Requirements

6.25.2.1 Cement

ACI 207.2R and 207.4R contain additional information on cement types and effects on heat generation. The following types of hydraulic cement are suitable for use in mass concrete construction:

- Portland cement—Types I, II, IV, and V, as covered by ASTM C 150;
- Blended cement—Types P, IP, S, IS, I(PM), and I(SM), as covered by ASTM C 595; and
- Hydraulic cement—Types GU, MS, HS, MH, and LH, as covered by ASTM C 1157.

6.25.2.2 Aggregates

Coarse and fine Aggregate properties should follow these specifications and ASTM C-125 and ACI 221 R.

Test sieve size, square mesh, in. (mm)	Percent by weight passing designated test sieve			
	Cobbles 6 to 3 in. (150 to 75 mm)	Coarse 3 to 1-1/2 in. (75 to 37.5 mm)	Medium 1-1/2 to 3/4 in. (37.5 to 19 mm)	Fine 3/4 in. to No. 4 (19 to 4.75 mm)
7 (175)	100			
6 (150)	90 to 100			
4 (100)	20 to 45	100		
3 (75)	0 to 15	90 to 100		
2 (50)	0 to 5	20 to 55	100	
1-1/2 (37.5)		0 to 10	90 to 100	
1 (25)		0 to 5	20 to 45	100
3/4 (19)			1 to 10	90 to 100
3/8 (9.5)			0 to 5	30 to 55
No. 4 (4.75)				0 to 5

Table 32, Grading requirements for Coarse Aggregate for Mass concrete (Chapter 6)

6.25.2.3 Water

Water used for mixing concrete should be free of materials that significantly affect the hydration reactions of Portland cement and should fulfill the requirement of these specifications.

6.25.3 Construction Requirements

6.25.3.1 Selection of Proportions

The primary objective of proportioning studies for mass concrete is to establish economical mixtures of proper strength, durability, and permeability with the best combination of available materials that will provide adequate workability for placement and least practical rise in temperature after placement. Proportion methods should follow the ACI 211.1, Appendix 5. Aggregate used for proportioning of mass concrete should be as follows:

Maximum size in concrete, in. (mm)	Percentage of cleanly separated Coarse aggregate fractions				
	Cobbles 6 to 3 in. (150 to 75 mm)	Coarse 3 to 1-1/2 in. (75 to 37.5 mm)	Medium 1-1/2 to 3/4 in. (37.5 to 19 mm)	Fine	
				3/4 to 3/8 in. (19 to 9.5 mm)	3/8 in. to No. 4 (9.5 to 4.75 mm)
6 (150)	20 to 30	20 to 32	20 to 30	12 to 20	8 to 15
3 (75)		20 to 40	20 to 40	15 to 25	10 to 15
1-1/2 (37.5)			40 to 55	30 to 35	15 to 25
3/4 (19)				30 to 70	20 to 45

Table 33, Ranges in each size fraction of Coarse Aggregate that have produced workable concrete (Chapter 6)

The batch weight of the cement is determined by dividing the total weight of the mixing water by the w/c or, when workability governs, it is the minimum weight of cement required to satisfactorily place the concrete. With the batch weights of cement and water determined and with an assumed air content of 3 to 5%, the remainder of the material is aggregate. The only remaining decision is to select the relative proportions of fine and coarse aggregate. The optimum proportions depend on aggregate grading and particle shape, and they can be finally determined only in the field and can be used after the approval from Engineer in Charge. For 6 in. (150 mm) aggregate concrete containing natural sand and gravel, the percentage of fine aggregate to total aggregate by absolute volume may be as low as 21%. With crushed aggregates, the percentage may be in the range of 25 to 27%.

6.25.3.2 Temperature control

The four elements of an effective temperature control program, any or all of which may be used for a particular mass concrete project, are:

- Cementitious material content control, where the choice of type and amount of cementitious materials can lessen the heat-generating potential of the concrete;
- Precooling, where cooling of ingredients achieves a lower concrete temperature as placed in the structure;
- Post cooling, where removing heat from the concrete with embedded cooling coils limits the temperature rise in the structure; and
- Construction management, where efforts are made to protect the structure from excessive temperature differentials by knowledge of concrete handling, construction scheduling, and construction procedures.

Before Placing the Mass Concrete contractor should develop a plan to reduce the temperature and should submit this plan to Engineer in Charge.

6.25.3.3 Placing

The placing temperature of mass concrete shall not exceed the planned temperature. During placing process, the temperature of concrete shall be measured, the thermal history of placed

concrete shall be monitored, and the plan for construction may be changed accordingly, if necessary.

One must keep in mind that the assumed conditions at design stage of thermal characteristic of materials and environmental conditions may differ from those at construction stage. When actual placing temperature exceeds the assumed placing temperature of mass concrete, the prevention of thermal cracking as well as the control of crack width may become difficult. As a result, the desired function and performance may not be satisfied. Therefore, Concrete temperature and temperature rise of laced concrete should be confirmed at the time of construction. The construction plan should be modified if the actual condition is too much different from the assumed one. Especially, when placing concrete under the scorching sun, special cares on the management of materials, concrete production, transportation, placing, etc. shall be applied to make sure that the actual placing temperature will not exceed the planned one. Since the exothermic properties of Portland blast furnace slag cement is accelerated if temperature is high, the placing temperature should be as low as possible in order to control the temperature rise.

6.25.3.4 Curing

In curing mass concrete, appropriate care shall be taken to control concrete temperature, so that thermal cracks can be controlled as per plan.

In the curing of mass concrete, adequate measures for thermal crack control based on the results of the verification and curing methods specified in the construction plans need to be taken additionally with the conditions required for the curing of normal concrete. Specifically, it is necessary to apply appropriate measures to cool down the concrete temperature as close to the ambient air temperature as possible, to keep the temperature difference between the interior and exterior of the concrete member as low as possible and to maintain the temperature drop rate of the whole member at acceptable level. If necessary, such measures as thermal insulation and protection of the concrete surface with adiabatic materials (styrol or sheet) should be implemented. The sprinkle of more water that necessary may lead to the formation of cracking by the decrease in the surface temperature of concrete.

The pipe cooling is used in order to reduce maximum internal temperature of young concrete and overall temperature of members to average temperature of concrete structure. Pipe cooling is carried out by pumping chilled water or natural river water through the pipes previously placed in concrete. In pipe cooling practice, thin-walled steel pipes of external diameter of approximately 25mm are usually used. Factors such as the space between pipes, water flow, and length of a coil as well as cooling-off duration should be determined to obtain the required effect. The temperature of cooling water also should be determined by considering placing time intervals, construction period, thickness of members, etc. If the temperature of cooling water is too low, temperature difference within a member or between members may cause crack initiation. Therefore, sufficient caution needs to be taken. Temperature difference between the circumference of cooling pipe and cooling water should be maintained less than 20°C. In pipe cooling practice, air can be used instead of water. Mass concrete using moderate-heat Portland cement, low-heat Portland cement and blast furnace slag cement requires sufficient curing with thermal insulation to obtain sufficient strength.

6.25.4 Measurement & Payment

Mass concrete should be measured in units of cubic feet and should be paid accordingly.

6.26

Materials and Construction of RCSPs Building System

Introduction

As the Sandwich panels are nowadays used for building construction, one might want to know how these panels are being constructed which is explained. Reinforced concrete sandwich panels consist of three layers. The middle layer is made up of Expanded Polystyrene (EPS) Foam. Instead of EPS any other type of polymer can be used. The outer layers, one on each side of the foam, consists steel mesh covered by sprayed concrete called as Shotcrete. The typical picture of SCIP wall is shown in figure 01.

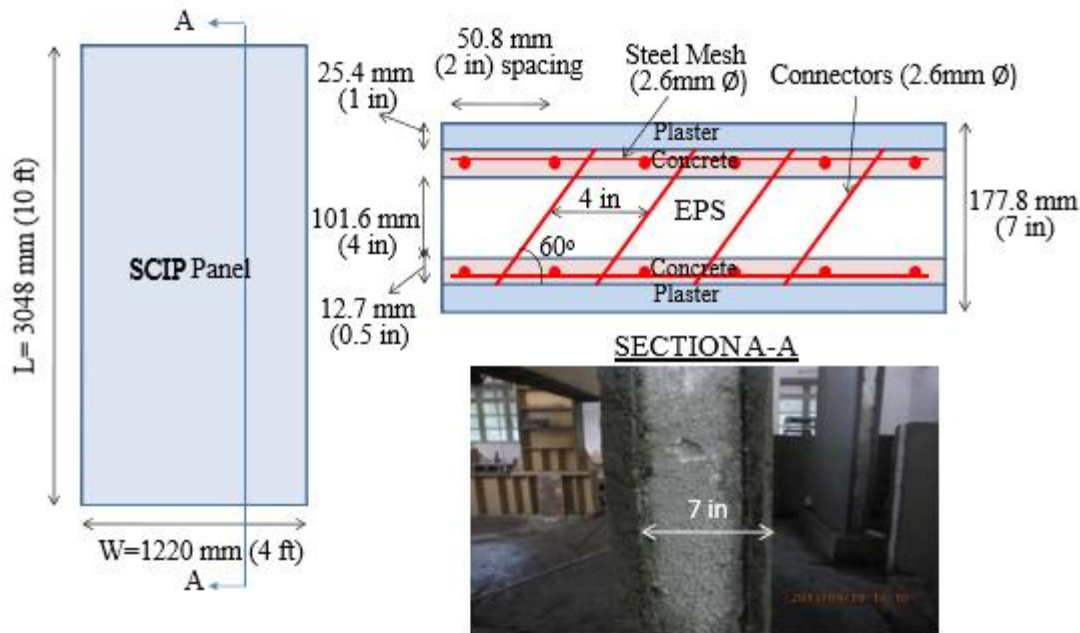

Figure 1 : SCIP panel details

Outer Layer

The two outer layers, also called “ faces or leaves”, are made up of stiff material e.g. concrete with a ratio of 1:2:1 with using zero pane crush instead of normal size aggregate or mortar (1:3). The ratios can vary according to the design requirements. Another material used in the concrete mix of the outer layers is Polypropylene (PP). Polypropylene is an organic material, 19mm (3/4 in) long, silk thin, white colored Monofilament fibres, are used in concrete to increase the adhesive force between the fibers and the concrete. It also increases cracking resistance properties of the concrete. Galvanized welded steel mesh of diameter ranging 2.5mm to 5mm is used as reinforcement inside the concrete. The spacing between these steel bars is usually 50mm (2”) and can be changed based on the design requirements. The range of concrete thickness is 25mm to 40mm. Steel mesh is connected to each other by means of

cross/diagonal connectors. The purpose of steel meshing is to increase the tensile strength of these panels under different loading conditions.

Middle Layer

Middle sandwiched layer, also called “core”, is composed of a relatively much lighter and less stiff material (EPS, metallic honeycomb, balsa wood etc.). The thickness of the core varies from 50mm (2”) to 100mm (4”) and has a density of 15 kg/m³ to 25kg/. The middle layer is provided for insulation purpose. Besides insulation it also plays a very important role in transferring shear between the layers. This transfer mechanism establishes composite action in the panels. The shear properties of the middle layer material and the strength of the joint play an important role in the shear transfer.

Construction of RCSPs Building System

Construction of RCSPs building system is totally different than masonry or frame building construction. The RCSPs building is easy to construct with less time and labor requirement. The construction of RCSP building consists of the following steps.

Foundation construction

The first step in construction of a building is the site layout plan. Usually lime is used for layout marking. Once the layout is done, excavation for foundation is started. Then reinforcement is tied as per design requirements. Up to this point the construction for ordinary brick masonry buildings and RCSPs building is the same. In case of RCSPs building dowels (reinforcement) of about 1ft or 1.5ft are left at certain spacing above the foundation so as to allow the insertion of the panels. These dowels can be provided either before pouring concrete into the foundation or after pouring by drilling holes in foundation’s concrete after hardening and putting epoxy resin or any other kind of resin to hold the reinforcement. The foundation setup is shown in figure 02 and 03.



Figure 02: Making of foundation



Figure 03: Leaving dowels in foundation

After preparation of foundation the required number of panels are transported from factory to the site and piled up according to the space and will be better if covered. The panels for the complete structure is shown in figure 04



Figure 04: Transportation of panel to site

Erection and Installation of Panel

The panel can easily be hand transported by one or two persons, even in the assembled way. Afterwards, during the assembling phase, it can be worked and manually positioned just by one person without the use of any lifting machine. This facilitates speeds up the installation of the panels in any situation. These operations do not demand any specialized laborers. All the panels are placed one by one inside the dowels. In order to join two panels extra steel mesh is provided at the joining point on both side and tied with the help of binding wire. This makes the structure monolithic and one complete body. All structural connections such as corners and joints or the most stressed locations are reinforced with a galvanized electro welded mesh for a better continuity. Windows and doors can be easily cut out from the panels using a cutting tool. The positioning of the floor is enormously simplified due to lightness and handiness of the panels. The panels are placed in the similar way and jointed as walls as shown in figure 05 and 06.



Figure 05 : Placing panels in dowels



Figure 06: Placed Slab panels on wall panels

Installation of utilities

The constructive speed of the system and its clean work are valued to utmost in the installation of various systems i.e. plumbing, heating, electricity etc as shown in figure 07. The chases in the foam are carried out with the simple hot jet of hot air. If needed, the metal mesh is cut in the required length in case of installation of rigid or semi rigid pipes. The cut mesh can again be put over the pipes and sprayed with concrete.



Figure 07: Installation of utilities before concretion

Concreting and Plastering

When all the panels have been joined together and the utilities have been installed, a special concrete mix is applied to these panels using “Hopper Gun” attached to a compressor/hydraulic pump. The spraying of concrete is called shotcreting which has been classified into two types in which one is spraying using wet concreting sprayed by pressure of compressor while other is called as Guniting in which dry material is used and the water is mixed during application at the nozzle of the spray as shown in figure 08. After concreting, plaster of required ratio is applied on these panels which makes the structure as it like normal structure.



Figure 08:Applying Concrete

Slab concreting:

The top surface of slab is concreting using any required mix with normal size aggregate and the concrete thickness is 2.5 inches on the top while the bottom size concreting is like the walls application.

Contents

CHAPTER – 7	BRICK MASONARY	5
7.1	General	5
7.1.1	Glossary	5
7.1.2	Classification of Bricks	7
7.1.3	Materials	7
7.1.4	Tools	7
7.1.5	Wetting of Bricks	7
7.1.6	Bond	7
7.1.7	Lying of Bricks	7
7.1.8	Joints	7
7.1.9	Corner	8
7.1.10	Round Pillars	8
7.1.11	Plumb Bobs and Straight Edges	8
7.1.12	Facework	8
7.1.13	Joining Works	8
7.1.14	Joints	8
7.1.15	Cut Brick Work	8
7.1.16	Fixtures	8
7.1.17	Progress	9
7.1.18	Bed Plate	9
7.1.19	Opening	9
7.1.20	Centering	9
7.1.21	Scaffolding	9
7.1.22	Putlogs	10
7.1.23	Lying of Bricks in Freezing Weather	10
7.1.24	Protection & Watering	11
7.1.25	Measurements	11
7.1.26	Sampling and Testing of Bricks	11
7.1.27	Rates	12
7.2	Brick Laying	13
7.2.1	Walling	13
7.2.2	Reinforced Brickwork	18
7.2.3	Scaffolds	18
7.2.4	Piers	19

7.2.5	Chimneys	19
7.2.6	Arches	21
7.3	Classification of Brick Work.....	23
7.3.1	Brick Work 1 st Class	23
7.3.2	Brickwork 2 nd Class	23
7.3.3	Brickwork 3 rd Class.....	24
7.3.4	Fourth Class Jhama Bricks	25
7.4	Brickwork in Arches	25
7.4.1	Material	25
7.4.2	Centering.....	25
7.4.3	Wedges and Sand Boxes	25
7.4.4	Building of Arches	25
7.4.5	Striking of Centre	26
7.4.6	Precautions for Relieving Arches	26
7.4.7	Other Respects	26
7.4.8	Measurement.....	26
7.4.9	Rate	26
7.5	Lining Tunnels with Bricks.....	28
7.5.1	Construction Requirements	28
7.6	Corbelling.....	30
7.6.1	Description.....	30
7.6.2	Other Respects	30
7.6.3	Measurement.....	30
7.6.4	Rate	30
7.7	Coping.....	31
7.7.1	Description.....	31
7.7.2	Other Respects	31
7.7.3	Measurement.....	31
7.7.4	Rate	31
7.8	Window Sills.....	32
7.8.1	Description.....	32
7.8.2	Other Respects	32
7.8.3	Measurement.....	32
7.8.4	Rate	32
7.9	Cornices	33
7.9.1	Description.....	33

7.9.2	Other Respects	33
7.9.3	Measurement	33
7.9.4	Rate	33
7.10	String Courses	34
7.10.1	Description	34
7.10.2	Other Respects	34
7.10.3	Measurement	34
7.10.4	Rate	34
7.11	Eave Brickwork	35
7.11.1	Description	35
7.11.2	Other Respects	35
7.11.3	Measurement	35
7.11.4	Rate	35
7.12	Drip Course	35
7.12.1	Description	35
7.13	Brickwork in Reimbursement to Drain	36
7.13.1	Description	36
7.13.2	Joints	36
7.13.3	Base	36
7.13.4	Strike	36
7.13.5	Other Respects	36
7.13.6	Measurement	36
7.13.7	Rate	36
7.14	Brickwork in Tega to Drain	37
7.14.1	Description	37
7.14.2	Base	37
7.14.3	Other Respects	37
7.14.4	Measurement	37
7.14.5	Rate	37
7.15	Sun – Dried Brickwork and Ghilafi Brick Work	37
7.15.1	Material and Construction Requirement for Sundried Brick	37
7.15.2	Ghilafi Brickwork	37
7.15.3	Measurement	38
7.16	Partition Walls	39
7.16.1	Brick Partition Walls	39
7.16.2	Clay Brick Partition Walls	42

7.16.3	Concrete Partition Wall.....	42
7.17	Cavity Wall	43
7.17.1	General.....	43
7.17.2	Materials Requirements.....	43
7.17.3	Construction Requirement	44
7.17.4	Measurements and Rate.....	44
7.18	Construction with Seismic Consideration.....	46
7.18.1	General.....	46
7.18.2	Width of foundation.....	46
7.18.3	Materials of foundation.....	46
7.18.4	Depth of foundation.....	46
7.18.5	Typical Foundations.....	46
7.18.6	Plinth Masonry	46
7.18.7	Walls	47
7.18.8	Joints.....	47
7.18.9	Seismic Strengthening Measures.....	47
7.19	Honey Comb Brick Work/Perforated Brick Masonry	48
7.19.1	Measurements.....	49

CHAPTER – 7 BRICK MASONRY

7.1 General

Unless otherwise specified, all brickwork shall be finished in a workmanlike manner, true to dimensions and grades shown on the drawings to the following specification.

7.1.1 Glossary

Frog:	Indentation formed on the bedding surface of a brick manufactured by molding or pressing. The indentation may be shallow (not exceeding 3/8" (9.5mm)). The frog face is to be kept upward in brickwork.
Course:	Row of bricks between two consecutive bed joints. Its thickness is taken as one brick plus one mortar joint.
Bed Joints:	Joints normal to the pressure.
Quoins:	External corners of walls. The term is sometimes used for bricks or stones which form the quoins e.g. quoin brick, quoin stone.
Prepends:	Vertical joints of the face of the wall. In plain walling it is necessary for good bond that these joints should, in alternate courses, be vertically one above the other.
Stretchers:	Bricks laid with their lengths on the face of wall or parallel to the face of wall.
Headers:	Bricks laid with their widths on the face of wall or parallel to the face of wall.
Bats:	Pieces of bricks and are usually known as 1/2 or 3/4 bat according to the fraction of a whole brick.
Lap:	Horizontal distance between the vertical joints in two consecutive courses. Queen Closers Bricks made with the same length and thickness but with half the width of a brick. They are usually placed next to the quoin header to obtain the lap. They are usually made economically by cutting the broken bricks.
King Closer:	Bricks which are cut in such a way that one end is half the width of the brick. They are used in the construction of reveals to avoid having any face brick less than four inches on the bed.
Squint Quoins:	Bricks cut or molded to form angles other than right angles in plan. They are cut to show a 3/4 brick on one face and a 1/4 brick on return. No closers are then used on the front of the brickwork.
Keyed brick:	Brick used to provide effective key for plaster.
Cellular brick:	Brick having hollow cells to lighten the weight of wall and to increase thermal insulation.

- Plinth bricks:** Bricks molded with a splay or molding of a projection of $2\frac{1}{4}$ and are used to form the top member of a projecting plinth.
- Bull-nose Bricks:** Bricks molded with an angle employed to form quoins. The radius of the curve lies on the long center line of the brick.
- Cow-nose:** Brick having double bull-nose on end brick.
- Junctions of Cross Walls:** The bond is obtained in cross or party walls abutting against main walls by placing a closer of $4\frac{1}{2}$ inches from the face in every alternate course in the main wall thus leaving a space $2\frac{1}{2}$ inches deep and having a length equal to the thickness of the cross wall for the reception of the $2\frac{1}{4}$ inches projection in every other course of the cross wall.
- Projecting Courses:** There are three cases in which it is necessary to enlarge the horizontal area of walls: first, to increase the area of the base to distribute the pressure over greater area of earth as in footing; secondly, to form a projection to afford a bearing area to support the ends of girders or joist; and thirdly, to obtain architectural effect, as in the construction of strings or cornices. The following two rules must be complied with in order to obtain the greatest efficiency. First, in any course the projection should not exceed one-fourth the length of the brick. This is to prevent the bricks from overturning, provided they are properly weighted at their back end. Secondly, all bricks as far as possible should be laid as headers; this renders the bricks more secure from being drawn from the wall.
- Footings:** They are the side courses placed at the base of a wall to distribute the pressure over a greater area of foundation.
- Corbelling:** It is sometimes necessary to support loads. It consists of one or more courses projecting a distance sufficient to afford the required bearing area for the load.
- Throating:** Groove on the surface of copings or string course.
- Coping:** Covering course of brickwork at the lightest to form the water-proof top for preventing the interior of the wall from wetting. Copings are commonly throated.
- Drip Course:** Drip course throws off water clear of walls. It has a throated under surface and is usually done over arches, doors and window sills and parapets.
- String Courses:** Horizontal projections of brickwork often constructed below windows.
- Flush joint:** Joint formed by slicing surplus surface mortar on the face of brickwork.
- Raked joint:** Joint formed by raking the mortar about $\frac{1}{4}$ inch or $\frac{3}{8}$ inch so that the joint is in shade. It is effective when the perpend is flush.
- Weathered joint:** Joint formed by drawing the point of trowel at a slight angle along the course. It is the best joint for reducing the ingress of water.

Mason's V joint: Where it is desired to produce the even looking joints, mason's V joint is formed.

7.1.2 Classification of Bricks

Unless otherwise specified, brickwork shall be of the following 2 classes:

1. Brickwork 1st Class
2. Brickwork 2nd Class
3. Brick Work 3rd Class
4. Brick Work 4th Class

7.1.3 Materials

Bricks: Bricks shall conform to book 1 (Specification for Engineering Material). of the specifications for Clay Bricks, unless otherwise specified. No bats shall be used, except where absolutely necessary for obtaining the dimensions of different courses or the specified bond.

Mortar: Mortar shall be contained in bill of quantities. It shall be prepared in accordance with the relevant provisions set forth in Chapter 15 of these specifications for the specified Mortar.

Water: Water in brickwork shall conform to Book 1 (Specification for Engineering Material).

7.1.4 Tools

All equipment used for mixing mortar, transporting it and for laying bricks shall be clean and free from set mortar, dirt, or other injurious foreign substances. It shall be thoroughly cleaned at the end of each day's work.

7.1.5 Wetting of Bricks

Before use all bricks, except sun-dried bricks, shall be soaked in clean water in a tank or pit for at least 2 hours. In the case of masonry in mud mortar, however, dry bricks shall be used.

7.1.6 Bond

Unless otherwise specified, all brickwork shall be laid in English Bond with facing frogs upwards.

7.1.7 Lying of Bricks

Each brick shall be set with both bed and vertical joints filled with mortar and thoroughly bedded in by tapping with handle of trowel. At every fourth course bricks shall be flushed with mortar and grouted full.

7.1.8 Joints

Horizontal joints shall be parallel and truly level, vertical joints in alternate course shall come directly over one another. Thickness of joints, unless otherwise specified, shall not be less than $\frac{1}{4}$ of an inch and shall not be more than $\frac{3}{8}$ of an inch. The height of 4 courses and 3 joints as laid shall not exceed more than 1 inch the height of 4 bricks as piled dry one upon the other.

7.1.9 Corner

At all corners alternate courses of bricks shall be laid header-wise and stretcher-wise so as to bond the two walls well together.

7.1.10 Round Pillars

Round pillars shall be built with quadrant shaped bricks; if the pillars are of considerable height flat circular discs of stone or cement concrete of the same diameter as the pillar about 3 inches thick shall be introduced at every 4 to 6 feet as bond stone. The cost of this operation will be included in the unit rate.

7.1.11 Plumb Bobs and Straight Edges

All brickwork shall be truly plumbed and each set of 4 brick course shall be checked with plumb bob and straight edge.

7.1.12 Facework

All face work shall be finished with neat drawn joints and pointed out if it has not to be plastered. If it has to be plastered the joints shall be raked out before any plaster is laid on. For face work the bricks shall be of true edges, uniform colour and correct dimensions. If specially required, face work shall be laid up with pressed bricks. All brick courses shall be so proportioned that they will work out evenly with the height of windows and doors. Backing of the pressed brickwork shall be done as per specifications for brickwork 1st class.

7.1.13 Joining Works

When fresh masonry is to join masonry that has partially or fully set, the exposed joining surface of the set masonry shall be cleaned, roughened and wetted so as to effect the best possible bond with the new work. All loose bricks and mortar shall be removed. In all cases, returns, buttresses, counterforts, etc., shall be built up well course by course and carefully bonded with the main wall and shall never be joggled on afterwards.

7.1.14 Joints

Striking Joints: Where in the case of brickwork in lime or cement mortar, pointing or plastering to the face work is not provided as a separate item the joints in face work shall be struck.

Raking Joints: The joints of brickwork, which is to be pointed or plastered, shall be raked out with a hook to a depth of half an inch. The raking shall be done before the mortar sets each day.

7.1.15 Cut Brick Work

Bricks shall be cut, dressed or grooved, as required for shaping jambs, fitting chowkats and for architectural features of the building. Corners shall be made with cut bricks; five bricks shall be used for each corner.

7.1.16 Fixtures

Holdfasts and similar fixtures shall be built in with the surrounding brickwork in their correct position in specified mortar. They shall be built in as the work progresses and not inserted later on into space left for them.

7.1.17 Progress

Brickwork shall be carried up in a uniform manner. No portion shall be raised more than 3 feet above another at the same time. Temporary spaces left during construction shall be racked and not toothed. Straight edges supplied to bricklayers shall have courses marked on them with saw cut or measuring rod shall be provided and the height of course shall be checked all over the building from time to time so as to keep all courses level.

7.1.18 Bed Plate

Bed plates of concrete or stone shall be provided under beam. They shall conform to the dimension given in the drawing and shall be carefully laid to correct level. Backing up, if necessary, shall be done with tiles or split bricks.

7.1.19 Opening

Door and window openings shall have flat or relieving arches or lintels spanning across them as shown on the drawing or as specified.

7.1.20 Centering

Centrings for all openings shall be strong enough to support the lintels or arches spanning the openings and shall remain in position till the brickwork has set. No additional payment will be made to the contractor for this item of work.

7.1.21 Scaffolding

The contractor shall provide all scaffolding, staging, ladders, etc. necessary for the work. All walls or other brickwork shall be securely braced and protected against damages by wind and storms during the construction period. No extra rate shall be paid for this item.

- Scaffolding Types by their Use

7.1.21.1 Single Scaffolding

Where plastering, pointing or any other finishing has been indicated for brick work, single scaffolding may be provided, unless otherwise specified. In single scaffolding, one end of the put-logs/pole shall rest in the hole provided in the header course of brick masonry. Not more than one header for each put-log/pole shall be left out. Such holes shall not be allowed in the case of pillars, brick work less than one meter in length between the openings or near the skew backs of arches or immediately under or near the structural member supported by the walls. The holes for putlogs/poles shall be made good with brick work and wall finishing as specified.

7.1.21.2 Double Scaffolding (Independent Scaffolding)

The brick work or tile work is to be exposed and not to be finished with plastering etc. double scaffolding having two independent supports, clear of the work, shall be provided.

7.1.21.3 Cantilever Scaffolding

Cantilever Scaffolding is a type of scaffolding in which the standards are supported on series of needles and these needles are taken out through holes in the wall called single frame type scaffolding. In the other type needles are strutted inside the floors through the openings and called independent or double frame type scaffolding. Care should be taken while construction of cantilever scaffolding. Conditions under which cantilever scaffolding shall be used: -

- When the ground does not have the capacity to support standards,
- When the Ground near the wall is to be free from traffic,
- When upper part of the wall is under construction.

7.1.21.4 Suspended Scaffolding

The working platform should be suspended from roofs with the help of wire ropes or chains etc. It should be raised or lowered to required level. This type of scaffolding should be used for repair works, pointing, paintings etc.

7.1.21.5 Trestle Scaffolding

The working platform shall support on movable tripods or ladders. Trestle scaffolding shall use for work inside the room, such as paintings, repairs etc., up to a height of 5m.

7.1.21.6 Steel Scaffolding

Steel scaffolding should construct by steel tubes which shall fixed together by steel couplers or fittings. It is very easy to construct or dismantle. It has greater strength, greater durability and higher fire resistance. It is not economical but will give more safety for workers. So, it is used extensively nowadays.

7.1.21.7 Measurement & Payment

All scaffolding used during brick work should be measured in square feet and shall be paid on rental basis.

7.1.22 Putlogs

Only headers shall be left out to allow a putlog to be inserted and not more than one brick shall be left out for each putlog. Under no circumstances shall putlogs be made immediately under or next to the impost or skew back of arches.

7.1.23 Lying of Bricks in Freezing Weather

i. Protection of Bricks:

All bricks delivered for use in freezing weather shall be fully protected immediately upon delivery by a weather-tight covering that will prevent the accumulation of water, snow or ice on the bricks; loose board covering shall not be permitted.

ii. Heating of Sand:

All sand shall be heated in such a manner as will remove all frost, ice or excess moisture but will prevent the burning or scorching of the sand.

iii. Heating of Bricks:

All frosted bricks shall be defrosted by heating them to a temperature of approximately 180oF.

iv. Heating of Water:

All water used shall be heated to a temperature of approximately 180°F.

v. Slaking or Soaking of Lime:

All slaking of quick lime or soaking of hydrated lime shall be done at a temperature of at least 60°F, and this temperature shall be maintained until lime is incorporated into the mortar.

vi. Protection of Mortar Against Freezing:

After the mortar has been mixed it shall be maintained at such temperature as will prevent its freezing at all times and if necessary, the contractor shall use metal mortar board equipped with oil torches. No anti-freeze liquid, salt or other substance shall be used in mortar, except when specified or permitted by the Engineer in-charge.

vii. Enclosures and Artificial Heat:

All work under construction shall be protected from freezing for a period of 48 hours by means of enclosures, artificial heat or by other suitable methods duly approved by the Engineer-in-charge.

7.1.24 Protection & Watering

All brickwork shall be protected during construction from the effects of rain and frost by suitable covering. The brickwork laid in cement or in cement & lime mortar shall be kept moist for a period of 10 days.

7.1.25 Measurements

Brickwork shall be measured by volume. The unit of measurement shall be 100 cubic feet. No deduction shall be made for openings having a superficial area of one square foot or less.

7.1.26 Sampling and Testing of Bricks**7.1.26.1 Sampling**

For carrying out compressive strength, water absorption, efflorescence and dimensional tests, the samples of bricks shall be taken by one of the methods given below: -

Sampling Bricks or Tiles from a Motion: Whenever practicable samples shall be taken whilst the bricks or tiles are being moved; for example, during loading or unloading, in this case the bricks or tiles shall be taken at random from each of a number of convenient portions of the consignment or batch. The portion chosen should be small enough in relation to the whole to provide the minimum number of samples specified below.

Sampling Bricks or Tiles from a Stack: Samples shall be taken each at random from a stack of bricks or tiles. The number of bricks required for the tests shall be taken from across the top of the stack, the sides accessible and from the interior of the stack by opening the trenches from the top. Whichever method is employed, a sample of 50 bricks/tiles shall be taken at

random from every consignment of 50,000 bricks/tiles or part thereof. The samples thus taken shall be stored in a dry place not in contact with the ground until the tests are made. The bricks for tests shall be taken at random from the sample.

7.1.26.2 Compressive strength

The average compressive strength of five representative bricks, when tested according to ASTM Designation C-67 shall have a minimum average compressive strength for various classes as given below in table. The compressive strength of any individual brick tested shall not fall below the min. average compressive strength specified for the corresponding class of brick by more than 20%.

Designation Average	compressive strength (lbs/Sq.inch)
First Class	2000
Second Class	1500
Third Class	1000
Fourth Class	725

Table 1 Compressive strength of bricks (Chapter 7)

7.1.27 Rates

7.1.27.1 Labor Rate

The unit rate (on labor rate basis) for brickwork shall include cost of carrying out brickwork, cutting bricks wherever required, curing and protecting as per above specifications specially included in the **BOQ**. It shall further include the rental cost of providing, using and removing scaffolding, shuttering, centering, staging, ladders, supports and other tools and plants required for carrying out brickwork as per above specifications.

7.1.27.2 Composite Rate

The unit rate shall include the cost of bricks, mortar and any other material required, in addition to the labor rate detailed in Section 7.1.26.1.

7.2 Brick Laying

Brickwork in Buildings:

7.2.1 Walling

The usual procedure for erecting a wall in bricks is to build its corners or extremities to a height of 2 to 3 ft. the bricks must be carefully plumed on both faces. The base of the corner is extended along the wall and is raked back as the work is carried up. The intermediate portion of the wall is then between the two corners. The bricks in the courses are kept level and straightened by building their upper edges to a line stretched between the corners. The entire wall should be carried up simultaneously, and no part of the wall should be built higher than 3 ft part so as to avoid the risk of unequal settlements before the mortar has sufficiently set.

7.2.1.1 Wall Classification

Walls are divided into two main types: -

- a. Load bearing walls: These include all solid building walls supporting a continuous load from the roofs and floors, and retaining walls for retaining earth and water.
- b. Non-load bearing walls: These include all panel filling walls which carry no superimposed load.

7.2.1.2 Durability of Brickwork

There are four main causes which impair the durability of brickwork: frost action, crystallization of soluble salts, chemical action and moisture movement. Since it is the presence of water in brickwork which is responsible for bringing these causes into action the first safeguard is to protect the work by avoiding unnecessary exposure and providing dampproof course, where practicable.

Frost can affect both the bricks and mortar, and its effects are fairly straight forward. The affected part spalls or crumbles with the action of ice-forming, in its saturated pores. Crystallization of salts and chemical action depends on the presence of soluble salts which may originate in the bricks or the mortar or both. The movement of salts to the surface of the wall is influenced by pore structure of its elements, so that some extent in incidence of efflorescence and crystallization by ensuring that the parts at which these actions would be least harmful are most porous. In the case of chemical action, an important type of failure occurs when clay bricks containing a dangerous proportion of calcium sulphate are bonded in mortar containing cement or covered with a rendering containing cement. In damp conditions the sulphate can combine with cement and cause general expansion and failure of work.

7.2.1.3 Thickness of Brick Walls

The thickness of brick walls is regulated by the following rules which only apply to walls not more than 45 feet long between supports or cross walls and buildings three story high. Local authority by-laws may be referred for detailed information. Walls built of various types of brickwork detailed in the table below, should not go beyond the maximum permissible height shown for various thickness, subject to the following further limitations:

- a. The bricks are not less than 9 inches long.

- b. The thicknesses of extended and party walls (i.e. walls separating adjoining buildings) is not less than 1/16th of the height of the story in the case of ordinary buildings and 1/14th in the case of warehouses. The thickness of walls below if increased to a like extent, though any such additional thickness is confined to piers, properly distributed, of which collective widths amount to 1/4th of the length of the wall.
- c. 13.5 inches is the minimum thickness for the external party walls of any story more than 10 feet high.
- d. Walls do not support super-incumbent external walls and are not built of burnt brick in mud mortar. The thickness of cross walls is 2/3rd the thickness of the external party walls but never less than 9 inches (except in case of bricks in cement suitably reinforced with steel). No wall should be considered as cross wall unless it is carried upto the floor of the top most story and unless in each story the combined area of openings and recesses is less than 50% of the wall area. Properly bonded cross walls may be considered return walls deforming the length of external or party walls.

Material of which the walls are built	F = safe pressure (ton/ft ²)	Maximum permissible height for a thickness of				
		9" (1 brick)	13 1/2" (1 1/2 bricks)	18" (2 bricks)	22 1/2" (2 1/2 bricks)	27" (3 bricks)
Burnt brickwork in 1:3 Cement	8	25	38	51	-----	-----
Burnt brickwork in Lime Cement, sand mortar (1:1:6)	4	16	24	32	40	-----
Burnt brickwork in mud	2 1/2	11	17	23	28	34
Sun-dried brick in mud	1	6	9	12	15	18

Table 2, Thickness of Brick Walls (Chapter 7)

These heights are calculated by the following formula:

$$\text{Height in feet} = (6F)^{0.7N}$$

F = Safe allowable pressure in tons/square feet.

N = thickness of wall in bricks.

In no case, the pressure on any portion of the wall should exceed the safe pressure given in column 2 of the table. Wherever it is necessary to exceed the pressure, the thickness of the wall shall be increased to satisfy this condition.

7.2.1.4 Resistance to Damp Penetration

Dampness is eliminated from buildings to provide healthy conditions and to protect the structure itself from decay and other effects such as efflorescence. Measures are, therefore, adopted to exclude rain or ground moisture. Rain falling on a brick wall can penetrate the body of the work through pores of the bricks and mortar or cracks in the joints. Resistance to water penetration through brick walls can be achieved by either of the two methods:

- a. The provision of a degree of absorption sufficient on hold, without full penetration, of greatest amount of water likely to accumulate the wall;

- b. The use of dense, impervious units and mortar and the avoidance, by good workmanship, of cracking through which penetration could occur.

From the point of view of excluding dampness, however, the mortar should not be richer in cement than is necessary. In addition to being exposed to the falling rain, brickwork may be in contact with more constant sources of dampness such as the ground or may have vulnerable points such as the base of a roof parapet. In such a situation it is customary to insert a damp-proof course of impervious material. Wall construction with two separate thickness of materials connected only with horizontal metal ties can be an effective method of excluding rain. The ties should be of correct design and be protected from mortar drippings during building to ensure that no water v. runs across them.

7.2.1.5 Thermal Insulation

The insulation provided by brickwork depends mainly on the thickness, design (i.e. whether solid or cavity), finish and dryness of structure. Variation in the type of bricks, unless cavity is used, does not make a great difference. Light porous bricks when dry would, however, give slightly less insulation than average clay bricks.

7.2.1.6 Wetting of bricks

The presence of water in mortar is necessary for the setting action to take place. Precautions should, therefore, be taken to prevent the work from drying too quickly. Bricks should be saturated before bending, except during frost, to remove all loose dust from the surface that is to be in contact with the mortar.

7.2.1.7 Bending of Bricks

While bending bricks, both the bed and side joints must be thoroughly flushed or filled up with mortar.

7.2.1.8 Levelling

While bending bricks, great care should be taken to keep all courses perfectly level. To do this, the footing and the starting course should be carefully leveled, using a spirit level with a stack at least 10 feet long.

7.2.1.9 Tothing

The usual method while levelling a brick wall which is to be continued at some future time is to tooth the wall. This consists in leaving alternate stretchers projecting 2¼ inches beyond the stretching courses above and below.

Usually, new cross walls are jointed to old main walls by cutting out a number of rectangular recesses in the main wall equal in width to the width of the cross wall, three courses in height, and half a brick in depth. A space of three courses is left between the sinking, and the new cross wall is then bonded into the recesses with cement mortar to avoid any settlement. The sinking should not be less than 9 inches apart, since in the cutting, the portion between is likely to become shaken and cracked. This is known as block bonding.

7.2.1.10 Thickening

Where old walls have to be thickened, recesses 9"x9"x4½" deep are usually cut, one in every yard square of the surface of the old wall. The new is then built against the old and block-bonded at every recess. The surface of the old work is well cleaned, brushed and wetted before the new work is added. This is also known as block-bonding.

7.2.1.11 Racking

Racking is the term applied to the method of arranging the edge of a brick wall, part of which is unavoidably delay while the remainder is carried up. The unfinished edge must not be built vertically or simply toothed, but should be set back 2½ inches in each course, with a maximum of twelve courses, to reduce the possibility and the unsightliness of defects caused by any settlement that may take place in the most recently built portion of the wall.

7.2.1.12 Stability of Brickwork

The stability of brickwork is affected in three general ways:

- a. By loading a given area of ground beyond its ultimate resistance, by an irregular concentration of great pressure on a sub-soil, by the tendency of the sub-stratum to slide or by eccentric loadings, the walls are thrown out of the upright, crack or disintegrated.
- b. By bad bonding, resulting in disintegrated.
- c. By side trusts which may be distributed or concentrated, and their tendency is to overturn the walls, they are provided for by designing the walls of a sufficient thickness, or by placing buttresses at regular intervals.

7.2.1.13 Bond & Bonds in Brickwork

Bond is the name given to any arrangement of bricks in which no vertical joints of a course is exactly over a vertical joint in another course immediately above or below it, and has the greatest possible amount of lap, which is usually 1/4th the length of a brick.

To ensure good bond the following rules should be rigidly adhered to:

- i. Brick must be arranged in a uniform manner.
- ii. Fewest possible bats are employed.
- iii. Vertical joints in every other course must be perpendicularly in line on the internal as well as external face.
- iv. Stretches are to be used only on the face of the wall; the interior should consist of headers only, as also the footings and corbels.
- v. When bedded, length of a brick should equal twice the width, plus a mortar joint.
- vi. Lateral lap between Perpend is ¼ of the brick length.

Common types of bonds used in brickwork are described as follows:

i. English Bond

It consists of one course of headers and one course of stretchers alternately. In this bond, bricks are laid as stretchers only on the boundaries of courses, thus showing on the face of the wall. The joints in a course running through from back to front of a wall must not be broken. The course which consist of headers with the expectation of the closer brick, which is always

placed next to the quoin header to complete the bond. These courses are called as heading, courses:

It may be noticed that in walls the thickness of which is a multiple of a whole brick the same course will show.

Either

- Stretchers in front elevation and stretchers in back elevation.

Or

- Header in front elevation and headers in back elevation.

But in walls whose thickness is an odd number of half bricks, the same course will show.

Either

- Stretchers in front elevation and headers in back elevation.

Or

- Header in front elevation and stretcher in back elevation.

In setting out the plan of a course to any width, the quoin or corner brick should be drawn; then next to the face (which in front elevation shows headers) closers should be to the required thickness of wall; after which all the front headers should be set out. The intervening space, if any, should always be filled in with headers.

ii. Double Flemish Bond

This has headers and stretchers alternatively in the same course with the headers centered on the stretchers above and below, both in front and back elevations. It is weaker than the English Bond because of the greater number of bats and stretchers, but is considered by some to look better on the face. It is also economical, since a large number of bats may be used in it and thus bricks broken in transit may be utilized. By using the Double Flemish Bond for walls one brick in thickness, it is easier to obtain a better appearance on both sides than with the English Bond.

iii. Single Flemish Bond

It consists in arranging the bricks a Flemish Bond on the face, and English Bond as backing. This is often done on the presumption that it attains the strength of the English Bond and the external appearance of the Double Flemish. It is generally used where expensive bricks are specified for facing. The thinnest wall where this method can be introduced is 1½ brick thick.

iv. Stretching Bond

Stretching bond also called running bond is used for half-brick thick walls such as partition walls, brick-noggin in partitions. All bricks are laid as stretchers upon the face. Walls constructed with stretcher bonds are not stable enough to stand alone in case of longer span and height.

v. Heading Bond

Heading bond is also known as header bond. All bricks in this bond show on face, it is used chiefly for rounding curves, for footings, corbels, cornices.

vi. Racking Bond

Wall as they increase in thickness increase in transverse strength but become proportionately weaker in a longitudinal direction, owing to the fact that stretchers are not placed in the interior

of walls. This defect is remedied by using racking course at rectangular intervals of four to eight courses in the height of a wall. The joints of bricks laid in this position cannot coincide with the joints of the ordinary courses directly above or below, the inclination to the face usually being determined by making the longitudinal distance between the opposite corners equal to the length of a brick. It is not advisable to use one racking course directly above another, as there is always a weakness at the junction of the racking with the face bricks.

Racking bonds are most effective when placed in the stretching courses in walls of an even number of half-bricks in thickness. In this way they are effective over a greater area than if they were placed in the heading courses.

The alternate courses of racking bonds should be laid in different directions in order to make the tie as perfect as possible. There are two varieties of racking bonds, viz. hearing bond and diagonal.

7.2.2 Reinforced Brickwork

Brickwork may advantageously be reinforced by iron and steel. Hoop-iron bond has been used for a considerable time, but probably in many cases without any exact knowledge of its true value.

Reinforcement skillfully applied adds considerable tensional strength to the brickwork. The mortar should be of good Portland cement, one to three of sand, and the reinforcement should be effectively bedded and surrounded with the mortar so the all air may be excluded, to prevent the rusting of the metal. All rods should be treated with two coats of bituminous paint. Where structures are erected on soils of unequal bearing value, or on the side of hill where sliding of the sub-stratum may take place, proper reinforcement is of great value to resist unequal settlement or the dislocation of parts of brickwork.

There are several proprietary makes of brick-reinforcement. all of which are coated with bitumen to avoid rusting. They are made in several widths and lengths.

7.2.3 Scaffolds

Temporary erections constructed to support a number of platforms at different heights so as to enable the workmen to get at their work and to raise the necessary material, are termed as scaffolds. A scaffold consists of a number of uprights, called standards, placed about 8 feet apart, which are Fir poles about 5 inches in diameter and 30 feet in length. Standard may be increased to any length by lashing a number of poles together; this is done on many occasions during the erection of the building. Standard rest with their bottom ends on the ground, but to increase their stability and prevent lateral motion the ends are often embedded for about 2 feet in the ground. If any difficulty is experienced in doing so a barrel filled with earth is employed to receive the ends of the pole, a York stone flag immediately beneath the standard extends the bearing surface; they are placed approximately 8 feet apart. Similar poles, called ledgers, are placed horizontally and with a vertical distance apart of 5 feet, and are lashed to the building side of the standards (5 feet being the greatest height the average man can work with ease).

Scaffolds form a frame which is erected about 4 feet 6 inches from the face of the intended building with which it is connected by means of horizontal members called putlogs. They take a bearing on the wall at one end, and on the ledgers to which some are lashed at the other end. Ledgers are wedged to the wall when it has been built sufficiently to permit this being done.

Putlogs are of square timber, usually 3"x3" and 5 feet long. The pieces are not cut but split, to ensure the length fibers being uncut. These are placed about 4 feet apart, and on them the

scaffold hoards are laid to form the platform. These boards are 12 feet long, 9"x 1½" in size; the ends are bound in hoop iron to prevent their splitting.

The scaffold boards at their heading joints are butted. Two putlogs are placed at this part about 4 inches apart to support the ends. About the edges of the staging, guard-boards are placed, consisting of boards placed on edge and nailed to the standards.

The frames are braced to add stiffness and prevent the scaffold from rocking. The braces consist of poles lashed to the outside of the frames to triangulate the latter. Unless otherwise specified, for 9-inch walls a scaffold is only required on one side but for walls of a greater thickness it is required on both sides.

7.2.4 Piers

Piers in brickwork are constructed to support loads transmitted to them by beams and girders, or to receive the thrusts of two or more arches, the resultant of which falls in a vertical line. The height of any isolated brick or stone pier should not exceed 18 times its least dimension. No pier should have a width less than 13 inches.

Attached Piers: Attached piers strengthen a wall at given intervals along its length. A usual spacing is 10 or 12 feet.

7.2.5 Chimneys

The function of the chimney flue is to remove smoke and other products of combustion from the fire to a position well above surrounding windows. Unfortunately, large quantities of air, which the fire has just warmed up, are also removed by the draught up the chimney. Flues need careful designing so that fires do not smother, and acids which are liable to form in flues slow combustion appliances cannot cause damage to the mortar in the chimney stack.

Types of fire	Size and type of flue
Open fire	Minimum diameter 7"; traditional size 9"x9" (flues must be purged, i.e. rendered with mortar or lined with clay or other fired liners.)
Domestic boiler, slow-combustion stoves, etc., burning non-smokeless fuels.	6" diameter with salt-glazed liners.
Domestic boiler, slow-combustion stoves, etc., burning exclusively smokeless fuels.	4" diameter flue with salt-glazed liners

Table 3, Chimney Flue Requirements (Chapter 7)

7.2.5.1 Draught

An open fire requires roughly four to six times the volume of air in a room per hour to keep it going satisfactorily. Only two air changes per hour are needed for purposes of health, so that two to four times as much air as is really required has to be heated up to produce comfortable conditions. This additional air comes from cracks, round window, under and between floor

boards. That is why draughts are one of the characteristic discomforts of rooms warmed by open fires. If these cracks are draught proofed, the fire may be starved of air and it may smoke.

Air supply to the fire should, therefore, be provided independently of the air in the room by means of pipes laid beneath the floor communicating with the outside air. These pipes should be 4 to 6 inches in diameter and should be arranged so that they can draw air from both sides of the house. (In a wind, the leeward side of a house is in reduced pressure, and air is then sucked along any ventilation pipe opening to one side only.) Ventilation pipes should be arranged to supply air to the space immediately below the grate.

In order to reduce the waste of air up the chimney, the bottom of the flue should be formed, immediately above the head of the fire, into a throat 8 to 10 inches wide, 4 inches from front to back, and 6 inches deep. Precast throat units and cast-iron throat units with register doors to ensure that the throat is formed to the right dimensions can be purchased.

7.2.5.2 Smoke shelf

Immediately above and to the back of the throat unit is the traditional site for the smoke shelf. It is not necessary to design the other features in the proper traditional manner. In fact some people consider that it is a trap for soot and may cause chimney fires.

There must be a smooth transition from the fireplace opening through the throat unit to the beginning of the flue with no cavities exposed at the back of the fireplace. The throat unit, of course, is not necessary where the appliance had its own flue connection, as in the case, a stove or boiler.

7.2.5.3 Flues

They should generally be positioned within the house so that the heat coming from them can warm the building. Flues placed on outside walls waste heat. The brickwork is also liable to get chilled below the dew point of the flue gases, and water vapors condense out on the flue lining, bringing with them Sulphur compounds, tar, acid, or ammonia. These compounds can and do attack the lime or the cement in the mortar, and can cause severe damage to chimney stacks, and leakage of flue gases back into the building. This acid attack is severe with slow combustion appliances and that is why it is necessary to provide a flue lining of salt-glazed drain pipes (sockets upwards) to remove the possibility of this type of attack. When these liners are used, the stove-connection is brought in at right angles to the flue, with the bottom end of the flue emptying over a vessel to collect the condensate. This can be removed from time to time through a flue door. If the walls of a flue are only half a brick thick the outside of the flue (within the building) must be plastered. If the flue passes through a roof of shingles or thatch, the flue must be thickened out to at least 9 inches - one brick thickness - to a distance of at least 4 inches above and below.

i). Insulation of Flues

Brickwork in flues slow combustion stoves and boilers where they are exposed to the outside air should be at least 9 inches thick and preferably constructed of an insulating block with fireclay liners. This insulation will reduce the risk of condensation in the flue.

ii). Inclination of Flues

The flue should not be inclined more than 45°, but if it is, the thickness of the top side of the slope should be at least one brick thick.

iii). Fixings

Wooden plugs should not be within 9 inches of a flue or nearer than 6 inches to a fireplace opening. Similarly, metal fastenings should be kept at least 2 inches away from a fireplace opening.

7.2.5.4 Hearths

Hearths should be constructed so that there is no danger of any fire spreading to combustible structure. Bye-laws lay down that the hearth must project 16 inches from the front of the fireplace and must be 6 inches thick. The jambs to the fire should be at least 9 inches thick. The thickness at the back of the fireplace opening can be reduced to 4½ inches except on party or party walls.

7.2.5.5 Chimney through roofs

Where the slope of the roof is not less than 10° the chimney should project above the ridge at least 2 feet. Where the chimney stack comes through the roof other than at the ridge, it must project through the roof a distance of 3 feet measured from the highest point of its junction with the roof.

7.2.5.6 Chimney Pots

There is no need for the chimney pot to project more than 2 to 3 inches from the top of the brick or stonework. The pot is merely a convenient termination to the flue and should not be exposed. The top of the brick or stonework should be flaunches to throw water to the side in order to prevent undue penetration of rain into brickwork. It is better to cap the top of the rack with an impervious material such as a concrete.

7.2.6 Arches

One method of spanning an opening in brickwork is to form an arch. A curved template of wood is placed in position and the voussoirs (bricks forming the arch) are bedded together on it. They transfer the weight of the wall into the abutments. Lateral thrust is produced, the amount of which depends upon the span, the rise of the arch and the load of the brickwork. This lateral thrust must be taken by either producing a sufficiently wide and heavy abutment or buttress, or by placing a similar arch alongside to balance the thrust.

If a square opening is cut in a plain brick wall, the brickwork within a 60° triangle above will tend to fall out, forming a triangle arch. This formation results from the diagonal support which each brick provides to the brick above. Therefore, a lintel only supports the weight of this triangular area.

i). Rough Arches

These arches are made of bricks which are not specially shaped to fit the curve of the arch. In order that the wedge-shaped mortar joints may not get unseemly thick near the top, stretchers are usually replaced by half bricks with perpends overlapping them. This form of construction is often used behind gauged arches so that the rather untidy half bricks are not seen.

ii). Gauged Arches

Here the bricks are formed to the tapered shape necessary to make neat jointing in the arch. A saw cut of 1/8 inch is first made in the brick to give a precise line of finish, and then the unwanted part of the brick removed by axing (with a bricklayer's axe or scutch). Alternatively, softer bricks may be used and instead of being axed may be rubbed with a rubbing stone or file.

iii). Relieving Arches

In the past relieving arches were often built over square opening to take most of the load. The fiat head of the opening was then carried on timber joists.

7.3 Classification of Brick Work

7.3.1 Brick Work 1st Class

The brickwork shall be executed in accordance with section 7.1 of these specifications using the specified mortar.

7.3.1.1 Material

i). Bricks

Bricks shall conform to the chapter 4 of book 1 (Specification for Engineering Material). Their size shall be as specified.

ii). Mortar

Mortars shall conform to Chapter-5 of Book-2 of these specifications as specified.

7.3.1.2 Other Respects

In all other respects it shall conform to section 7.1 of these specifications.

7.3.1.3 Measurement

Brickwork shall be measured by volume. The unit of measurement shall be 100 cubic feet. No deduction shall be made for openings having a superficial area of one square foot or less.

7.3.1.4 Rate

i). Labor Rate

The unit rate (on labor rate basis) for brickwork shall include cost of carrying out brickwork, cutting bricks wherever required, curing and protecting as per above specifications specially included in the contract. It shall further include the cost of providing, using and removing scaffolding, shuttering, centering, staging, ladders, supports and other tools and plants required for carrying out brickwork as per above specifications.

ii). Composite Rate

The unit rate shall include the cost of bricks, mortar and any other material required, in addition to the labor rate detailed in Section 7.3.4.1.

7.3.2 Brickwork 2nd Class

The work covers brickwork 2nd class in accordance with Section 7.1 of these specifications using the specified mortar.

7.3.2.1 Materials

i). Bricks

Bricks shall conform to chapter 4 of book 1 (Specification for Engineering Material). Their size shall be as specified.

ii). Mortar

It shall conform to Chapter-5 of Book-2 of these specifications as specified.

7.3.2.2 Other Respects

In all other respects it shall conform to section 7.1 of these specifications.

7.3.2.3 Measurement

Brickwork shall be measured by volume. The unit of measurement shall be 100 cubic feet. No deduction shall be made for openings having a superficial area of one square foot or less.

7.3.2.4 Rate**i). Labour Rate**

The unit rate (on labour rate basis) for brickwork shall include cost of carrying out brickwork, cutting bricks wherever required, curing and protecting as per above specifications specially included in the contract. It shall further include the cost of providing, using and removing scaffolding, shuttering, centering, staging, ladders, supports and other tools and plants required for carrying out brickwork as per above specifications.

ii). Composite Rate

The unit rate shall include the cost of bricks, mortar and any other material required, in addition to the labour rate detailed in Section 7.4.4.2.

7.3.3 Brickwork 3rd Class**7.3.3.1 Construction Requirements****Bricks**

Bricks shall conform to the specifications given in this Volume for brickwork.

7.3.3.2 Laying of Brickwork

Brickwork shall be laid in accordance with the Specifications given in this Volume for Brickwork (General) with the following exceptions:

- No Cut brick shall be executed with third class bricks.
- Joints in third class bricks shall be ½ inch, but shall, in no case, exceed 5/8 inch.
- The height of 4 courses laid according to the allow specifications with 4 horizontal joints shall not exceed 2 inches the height of 4 bricks piled dry one upon another.
- Third class brick work shall not be bonded with any other class of brickwork.
- Third class shall never be allowed for face work.

7.3.3.3 Other Respects

In all other respects it shall conform to the specifications given in this Volume for Brickwork (General)

7.3.4 Fourth Class Jhama Bricks

Jhama bricks are bricks so over-burnt as to get vitrified or distorted and are useless for exact work. Their compressive strength shall not be less than 725 lbs. per square inch. They may be broken up for ballast provided the vitrified mass has not become porous or spongy in the process of being over-burnt.

7.4 Brickwork in Arches

The work covers brickwork in Arches.

7.4.1 Material

Bricks

1st class bricks shall conform to chapter 4 of book 1 (Specification for Engineering Material).

Mortar

Mortar composition as mentioned in BOQ shall conform to Chapter-5 of Book-2 of these specifications.

7.4.2 Centering

Centering shall be strong enough to bear the weight of an arch without any deflection. The surface of centering shall be correctly struck to the curvature of the soffit of the arch.

7.4.3 Wedges and Sand Boxes

Centers of arches over 5 feet in span shall be erected on wedges, those over 10 feet in span on double wedges and those over 20 feet span on sand boxes so as to allow the gradual lowering of center (i.e. striking).

7.4.4 Building of Arches

The building of Arches shall not commence till abutments have been built to their full width and up to the level of skew backs. Arch work shall be carried up evenly from both abutments and as soon as the arch is complete, masonry shall be built up evenly on both sides to the heights of the crown so as to load the haunches. The brickwork in arches shall conform to Section 32-1 of these specifications, except with the following modifications.

- a) In all arches, the voussoir joints shall be truly radial. Bricks shall be laid in full beds of mortar and shall be thoroughly rubbed and pressed into their beds so as to squeeze out surplus mortar and leave the joints as thin as possible.
- b) Joints in arches shall not exceed $\frac{1}{4}$ inch in thickness at any point Radial joints in gauged arches shall not exceed $\frac{1}{8}$ inch in thickness.
- c) Skewbacks shall be formed of bricks correctly shaped to radiate from the center of curvature and shall not be packed with mortar or chips. Before the building of an arch is commenced abutments shall be exactly as the same level and skewbacks in place.
- d) For gauged arch work, the arch shall be laid out full size on the ground on lime plaster and all joints carefully marked out.
- e) Templates shall then be made as a guide for the special shapes of bricks. Special bricks shall, where possible, be molded and burnt but if the amount of work is small,

they shall conform to the requirements of the Engineer in-charge and shall be carefully cut and rubbed to the required shape. All bricks for an arch shall be prepared in full and set up dry on the ground before the work begins.

- f) Segmental arches used over rectangular door or window openings shall have a flat rectangular soffit and segmental extrados.
- g) Flat arches shall be built in the same manner as gauged arches but with all the voussoir joints converging on the apex of an equilateral triangle described on the soffit of the arch. Cross joints and extrados shall be parallel to the soffit. The arch shall be built with a camber of 1/8 per foot of span.
- h) Arches shall be built in concentric rings and each ring shall be completed before work on the one above it is commenced. In all cases, whether, specially molded brick or ordinary bricks are used, the center line of the brick face shall be radially placed. The arch rings shall, in all cases, be bonded together by a special bond stone (key stone) which shall be of stone concrete or brickwork, as actually specified or shown on the drawing.

7.4.5 Striking of Centre

Centre shall be struck as noted below:

- a) For single segmental arch, center shall be struck immediately after the arch is finished.
- b) For series of segmental arches, center of each arch shall be struck as soon as the arch succeeding it is completed.
- c) For semi-circular, elliptical or pointed arches, centers shall be struck as soon as the brickwork has reached two-thirds the height of such arches.

7.4.6 Precautions for Relieving Arches

The space between the relieving and flat arches shall not be filled till the wall has been completed.

7.4.7 Other Respects

In all other respects it shall conform to section 7.1 of these specifications.

7.4.8 Measurement

It shall be measured by volume. The unit of measurement shall be 100 cubic feet. No deduction shall be made for openings having a superficial area of one square foot or less.

7.4.9 Rate

7.4.9.1 Labor Rate

The unit rate (on labor rate basis) for brickwork in arches shall include cost of carrying out brickwork, cutting bricks wherever required, curing and protecting as per above specifications specially included in the contract. It shall further include the cost of providing, using and removing scaffolding, shuttering, centering, staging, ladders, supports and other tools and plants required for carrying out brickwork as per above specifications.

7.4.9.2 Composite Rate

The unit rate shall include the cost of bricks, mortar and any other material required, in addition to the labor rate detailed in Section 7.4.9.1.

7.5 Lining Tunnels with Bricks

7.5.1 Construction Requirements

This Section covers the lining of new tunnels and the relining of old tunnels through ordinary formation.

7.5.1.1 Bricks

First class bricks or vitrified bricks shall have a crushing strength of not less than 2,000 lbs. per square inch and when broken in two parts and immersed in water for 24 hours, shall not absorb water in excess of 3% of their weight.

7.5.1.2 Mortar

The mix of the mortar shall be as shown on the drawing and, if not shown on the drawing, as specified. It shall conform to the Specifications for Mortar given in this Volume.

7.5.1.3 Side Walls and Arches

In side walls, the bricks shall be laid with their 4 inches by 8½ inches face up, and every fifth course shall be headers; in arches, every alternate course shall be headers, and joints shall not be less than ¼ of an inch and not more than ½ of an inch thick. All joints must be filled solidly with mortar. The space between the natural face of the tunnel and brick lining shall be filled with concrete or hard durable stone, thoroughly rammed, or tamped into place. When it is necessary to temporarily support the face of the excavation with steel or timber supports, the space between the liner plates or lagging and the face of the excavation shall be firmly packed with hard durable stone rammed into place or sand placed pneumatically. The space between the lagging or liner plates and the brick lining shall be filled with concrete or hard durable stone thoroughly rammed or tamped into place.

7.5.1.4 Drainage Openings

Weep holes shall be placed through the side walls at intervals of not less than 20 feet, unless drainage conditions require closer spacing. These holes shall be formed of cast-iron pipe not less than 4 inches in diameter and placed on a slope of 45°. The outer end of weep holes shall not be less than 12 inches above the bottom of the side drains.

Where the tunnel floor is paved with concrete and where moisture is present in the sub-grade below the concrete, invert, perforated drains to the gutter as required and shown on the drawings shall be provided. Four inches round drains shall be provided through the concrete ballast wall to provide drainage of the ballast section.

Side wall drainage shall be installed at no less than 20 feet centers and where moisture is present, at closer spacing, if groundwater is present, vertical and diagonal openings, trench drains, or iron pipe drains shall be provided in the rear of the lining. The drains shall be carefully installed and adequately anchored and shall terminate in openings through bricks of not less than 4 inches in diameter. Openings through the bricks shall be provided using cast-iron pipe with the outer ends of the outlets not less than 12 inches above the bottom of the side drains.

7.5.1.5 Refuge Niches

Refuge niches shall be at least 7 feet high and the dimensions as shown on the drawings. In single track tunnels the brickwork at back of niches should not be less than 1 course thick. Niches should be spaced approximately 100 feet apart and staggered with opposite side so

that niches will occur every 50 feet in the tunnel. The bottom of niches shall be at the elevation or the base of rails.

7.5.1.6 Other Respects

In all other respects it shall conform to the Specifications given in this Volume for Brickwork in Arches.

7.6 Corbelling

7.6.1 Description

Unless otherwise specified or directed by the Engineer-in-charge, corbelling shall be affected by 1/4th brick projection in ordinary work and 1/8th brick projection in a work where greater strength is required.

7.6.2 Other Respects

In all other respects it shall conform to the specifications given in this volume for brickwork first class.

7.6.3 Measurement

It shall be measured by volume. The unit of measurement shall be 100 cubic feet. No deduction shall be made for openings having a superficial area of one square foot or less.

7.6.4 Rate

7.6.4.1 Labor Rate

The unit rate (on labor rate basis) for corbelling shall include cost of carrying, cutting wherever required, curing and protecting as per above specifications specially included in the contract. It shall further include the cost of providing, using and removing scaffolding, shuttering, centering, staging, ladders, supports and other tools and plants required for carrying out brickwork as per above specifications.

7.6.4.2 Composite Rate

The unit rate shall include the cost of corbelling, mortar and any other material required, in addition to the labor rate detailed in Section 7.6.4.1.

7.7 Coping

7.7.1 Description

Unless otherwise specified, the top courses of all plinths, parapets, steps, etc., shall be built in brick on edge. In case of parapet walls the outside half of the brick shall be weathered and throated. The corners shall be made by cutting fine bricks or by special bricks of 9" x 9" x 4-3/8" size to give a radiated and keyed joint.

7.7.2 Other Respects

In all other respects it shall conform to the specifications given in this volume for brickwork first class.

7.7.3 Measurement

It shall be measured by volume. The unit of measurement shall be 100 cubic feet. No deduction shall be made for openings having a superficial area of one square foot or less.

7.7.4 Rate

7.7.4.1 Labor Rate

The unit rate (on labor rate basis) for coping shall include cost of carrying, cutting wherever required, curing and protecting as per above specifications specially included in the contract. It shall further include the cost of providing, using and removing scaffolding, shuttering, centering, staging, ladders, supports and other tools and plants required for carrying out brickwork as per above specifications.

7.7.4.2 Composite Rate

The unit rate shall include the cost of coping, mortar and any other material required, in addition to the labor rate detailed in Section 7.7.4.2.

7.8 Window Sills

7.8.1 Description

Unless otherwise specified, window sills shall be made by laying brick on edge over 1½ inch tile creasing to keep the joints in line. The bricks shall project 3 inches from the face of the wall and shall be weathered on the upper edge and throated underneath up to 3 inches from either end.

7.8.2 Other Respects

In all other respects it shall conform to the specifications given in this volume for brickwork first class.

7.8.3 Measurement

It shall be measured by volume. The unit of measurement shall be 100 cubic feet. No deduction shall be made for openings having a superficial area of one square foot or less.

7.8.4 Rate

7.8.4.1 Labor Rate

The unit rate (on labor rate basis) for window sill shall include cost of carrying, cutting wherever required, curing and protecting as per above specifications specially included in the contract. It shall further include the cost of providing, using and removing scaffolding, shuttering, centering, staging, ladders, supports and other tools and plants required for carrying out brickwork as per above specifications.

7.8.4.2 Composite Rate

The unit rate shall include the cost of window sills, mortar and any other material required, in addition to the labor rate detailed in Section 7.8.4.2.

7.9 Cornices

7.9.1 Description

Unless otherwise specified or directed by the Engineer-in-charge, all cornices shall be in line with the straight and parallel faces. All exposed cornices shall be weathered and rendered on top in specified mortar and throated underneath. The profile shall be checked constantly with the sheet iron templates. Cornices intended to be pointed shall be made with specially molded bricks or bricks cut and rubbed so as to give moldings true to drawings. In cornices to be plastered the bricks shall be roughly cut so as to allow the plaster to finish true to drawings and templates. Thickness of plaster shall not be less than half an inch and more than one inch.

7.9.2 Other Respects

In all other respects it shall conform to the specifications given in this volume for brickwork first class.

7.9.3 Measurement

The measurement of cornice shall be done by length. The unit of measurement shall be one running foot.

7.9.4 Rate

7.9.4.1 Labor Rate

The unit rate (on labor rate basis) for cornices shall include cost of carrying, cutting wherever required, curing and protecting as per above specifications specially included in the contract. It shall further include the cost of providing, using and removing scaffolding, shuttering, centering, staging, ladders, supports and other tools and plants required for carrying out brickwork as per above specifications.

7.9.4.2 Composite Rate

The unit rate shall include the cost of cornices, mortar and any other material required, in addition to the labor rate detailed in Section 7.9.4.3.

7.10 String Courses

7.10.1 Description

String courses shall comprise bricks laid on edge or flat in one or two courses as actually specified.

7.10.2 Other Respects

In all other respects it shall conform to the specifications given in this volume for brickwork first class.

7.10.3 Measurement

It shall be measured by volume. The unit of measurement shall be 100 cubic feet. No deduction shall be made for openings having a superficial area of one square foot or less.

7.10.4 Rate

7.10.4.1 Labour Rate

The unit rate (on labour rate basis) for string courses shall include cost of carrying, cutting wherever required, curing and protecting as per above specifications specially included in the contract. It shall further include the cost of providing, using and removing scaffolding, shuttering, centering, staging, ladders, supports and other tools and plants required for carrying out brickwork as per above specifications.

7.10.4.2 Composite Rate

The unit rate shall include the cost of string courses, mortar and any other material required, in addition to the labour rate detailed in Section 7.10.4.2.

7.11 Eave Brickwork

7.11.1 Description

Eave bricks shall be laid flat or on edge as specified with a projection of 3 inches and chamfered 1½ inch on the upper edge.

7.11.2 Other Respects

In all other respects it shall conform to the specifications given in this volume for brickwork first class.

7.11.3 Measurement

Eave brickwork shall be measured by length. The unit of measurement shall be one running foot.

7.11.4 Rate

7.11.4.1 Labor Rate

The unit rate (on labor rate basis) for eave brickwork shall include cost of carrying, cutting wherever required, curing and protecting as per above specifications specially included in the contract. It shall further include the cost of providing, using and removing scaffolding, shuttering, centering, staging, ladders, supports and other tools and plants required for carrying out brickwork as per above specifications.

7.11.4.2 Composite Rate

The unit rate shall include the cost of eave brickwork, mortar and any other material required, in addition to the labor rate detailed in Section 7.11.4.2.

7.12 Drip Course

7.12.1 Description

Brickwork in drip courses when made of flat bricks, shall conform to 7.11 "Eave brick work" of these specifications for Eave Brickwork and measured at the same rate. When built in brick on edge it shall conform to 7.8 "Window Sills" of these specifications for Window Sills and measured and paid at the same rate. Punjab Communication and Works Department Standard Specifications for Building Construction.

7.13 Brickwork in Reimbursement to Drain

7.13.1 Description

Bricks shall be laid flat or on edge as shown on drawings or as specified. Each brick shall be set on a layer of at least $\frac{1}{4}$ inch mortar with vertical joints filled with mortar and bedded in by tapping with the handle of the trowel. The width of reimbursement shall be 9 inches and shall be constructed on sides of the roads sloping towards the drain; the slope shall be $\frac{1}{8}$ of an inch in 9 inches. Cut and dressed bricks shall be laid in reimbursements for laying narrow strips in width along sides of drain, for all curves, bends, slopes, change of slopes and irregular areas. No extra amount shall be paid for any difficulty or complicated items required during execution.

7.13.2 Joints

The thickness of the joint shall not be less than $\frac{1}{4}$ of an inch and not more than $\frac{3}{8}$ of an inch. All joints between bricks and along outer end and inner side of reimbursement shall be completely filled with mortar and struck.

7.13.3 Base

The base concrete shall be of specified thickness.

7.13.4 Strike

All strips, sides and narrow width areas shall be filled with bricks on edge or flat.

7.13.5 Other Respects

In all other respects it shall conform to the specifications given in this volume for brickwork first class. The base concrete shall be paid separately.

7.13.6 Measurement

The brickwork in reimbursement shall be measured by length. The unit of measurement shall be one running foot. Punjab Communication and Works Department Standard Specifications for Building Construction.

7.13.7 Rate

7.13.7.1 Labour Rate

The unit rate (on labour rate basis) for eave brickwork shall include cost of carrying, cutting wherever required, curing and protecting as per above specifications specially included in the contract. It shall further include the cost of providing, using and removing scaffolding, shuttering, centering, staging, ladders, supports and other tools and plants required for carrying out brickwork as per above specifications.

7.13.7.2 Composite Rate

The unit rate shall include the cost of brickwork in reimbursement, mortar and any other material required, in addition to the labour rate detailed in Section 7.13.7.1.

7.14 Brickwork in Tega to Drain

7.14.1 Description

Bricks shall be laid on end, 3 inches or 4½ inches in thickness as specified on a bed not less than ¼ of an inch and not more than 3/8 of an inch thick. All external surface joints shall be struck.

7.14.2 Base

The base concrete shall be of specified thickness.

7.14.3 Other Respects

In all other respects it shall conform to 7.1 of these specifications.

7.14.4 Measurement

It shall be measured by volume. The unit of measurement shall be 100 cubic feet. No deduction shall be made for openings having a superficial area of one square foot or less.

7.14.5 Rate

7.14.5.1 Labour Rate

The unit rate (on labour rate basis) for brickwork in tega shall include cost of carrying out brickwork, cutting bricks wherever required, curing and protecting as per above specifications specially included in the contract. It shall further include the cost of providing, using and removing scaffolding, shuttering, centering, staging, ladders, supports and other tools and plants required for carrying out brickwork as per above specifications.

7.14.5.2 Composite Rate

The unit rate shall include the cost of bricks, mortar and any other material required, in addition to the labour rate detailed in above section 7.14.5.1.

7.15 Sun – Dried Brickwork and Ghilafi Brick Work

7.15.1 Material and Construction Requirement for Sundried Brick

7.15.1.1 Bricks

Bricks shall be in accordance with the provision and requirement set forth in clay brick the specification given in book 1 (Specification for Engineering Material) for sundried bricks. The brickwork shall be laid in accordance with the specifications given in this book for brickwork (general).

7.15.2 Ghilafi Brickwork

7.15.2.1 Scope

The ghilafi brickwork shall consist of first-class brickwork laid in mud mortar at the outer face and the balance work shall be executed in sun dried bricks laid on mud mortar on the inner

side conforming to these specifications. The unit rate for brick work on labor rate basis shall include the cost of carrying out brick work, cutting bricks, whenever required and curing and protecting as per specifications. It shall also include the cost of using and removing scaffolding, shuttering, centering staging, ladders, supports and other tools and plants required for carrying out brick work as per specifications. The unit rate shall include the cost of pucca bricks, sun-dried bricks, mud mortar and any other material required, in addition to the labour rates.

7.15.3 Measurement

Ghilafi work shall be measured by volume. The unit of measurement shall be 100 cubic feet.

7.15.2.1 Labor rate

The unit rate (on labor rate basis) for brickwork shall include cost of carrying out brickwork, cutting bricks whenever required, curing and protecting as per above specifications and/or any other specifications specially included in the contract. It shall further include the cost of providing, using and removing scaffolding, shuttering, centering, staging, ladders, supports and other tools and plants required for carrying out brickwork as per above specifications.

7.15.2.2 Composite rate

The unit rate shall include the cost of pucca brick, sun dried bricks, mud mortar and any other material required, in addition to the labor rates detailed in above section 7.15.2.1.

7.16 Partition Walls

7.16.1 Brick Partition Walls

7.16.1.1 Plain Brick Partition Walls

1. General

Brick masonry partition walls shall be one brick thick either flat or on edge.

2. Bricks

Bricks used for construction of partition walls shall confirm to the specifications under subsection 7.3.

3. Mortar

The partition walls shall be set in cement mortar not less than 1:3 proportions unless otherwise specified.

4. Soaking of Bricks

Soaking of bricks shall conform to the following details as given below: -

Bricks shall be soaked in water before use for a period for the water to just penetrate the whole depth of the bricks. The soaking of bricks would be for 2 to 3 hrs. Alternatively bricks may be adequately soaked in stacks by profusely spraying with clean water at regular intervals for a period not less than six hours. The bricks required for masonry work using mud mortar shall not be soaked. When the bricks are soaked, they shall be removed from the tank sufficiently early so that at the time of application they are skin-dry. Such soaked bricks shall be stacked on a clean place where they are not again spoiled by dirt earth etc.

Note 1: The period of soaking may be easily found at site by a field test in which the bricks are soaked in water for different periods and then broken to find the extent of water penetration. The least period that corresponds to complete soaking will be the one to be allowed for in construction work.

Note 2: If the bricks are soaked for the required time in water that is frequently changed the soluble salt in the bricks will be leached out, and subsequently efflorescence will be reduced.

5. Workmanship

Workmanship in the partition walls is to be the best quality as due to the small thickness of walls great care is to be taken. The total height of the wall in one day shall not exceed 4 feet.

6. Curing

Curing shall be carried out in the manner as given below: -

The brick work shall be constantly kept moist on all faces for a minimum period of seven days. Brick work done during the day shall be suitably marked indicating the date on which the work is done so as to keep a watch on the curing period.

7. Measurement

The measurement and rate shall be as specified below.

Brick work shall be measured in cubic meters unless otherwise specified. Any extra work over the specified dimensions shall be ignored. Dimensions shall be measured correct to the nearest 0.01 m i.e. 1 cm. Areas shall be calculated to the nearest 0.01 sq. mtrs and the cubic contents shall be worked out to the nearest 0.01 cubic meters.

Brick work shall be measured separately in the following stages: -

- From Foundation to Floor one Level (Plinth Level)
- Plinth (floor one) level to floor two level
- Between two specified floor levels above floor two level

Note: Brick work in parapet walls, mumty, lift machine room and water tanks constructed on the roof up to 1.2 m height above roof shall be measured together with the corresponding work of the floor next below.

No deductions or additions shall be done and no extra payment made for the following: -

Note: Where minimum area is defined for deduction of an opening, void or both, such areas shall refer only to opening or void within the space measured.

- Ends of dissimilar materials (that is, joists, beams, lintels, posts, girders, rafters, purlins, trusses, corbels, steps, etc.); up to 0.1 m² in section;
- Opening up to 0.1 m² in area (see Note);
- Wall plates, bed plates, and bearing of slabs and the like, where thickness does not exceed 10 cm and bearing does not extend over the full thickness of wall;
- Cement concrete blocks as for hold fasts and holding down bolts;
- Iron fixtures, such as wall ties, pipes up to 300 mm diameter and hold fasts for doors and windows; and
- Chases of section not exceeding 50 cm in girth.
- Bearing portion of drip course, bearing of moulding and cornice.

Note: In calculating area of an opening, any separate lintel or sills shall be included with the size of the opening but end portions of lintel shall be excluded. Extra width of rebated reveals, if any, shall also be excluded.

Walls half brick thick and less shall each be measured separately in meters for the sizes of bricks, half brick thickness shall mean 115 mm.

Where fractions of half brick occur due to architectural or other reasons, measurement shall be as follows: -

- up to 1/4th brick-actual measurements and
- Exceeding 1/4 brick-full half bricks.

String courses, projecting pilasters, aprons, sills and other projections shall be fully described and measured separately in running meters stating dimensions of each projection. Square or rectangular pillars shall be measured separately in cubic meters in multiple of half brick. Circular pillars shall be measured separately in cubic meters as per actual dimensions. Brick

work curved on plan shall be measured like the brick work in straight walls and shall include all cutting and wastage of bricks, tapered vertical joints and use of extra mortar, if any. Brick work curved on plan to a mean radius not exceeding six meters shall be measured separately and extra shall be payable over the rates for brick work in straight walls. Nothing extra shall be payable if the mean radius of the brick work curved in plan exceeds six meters. Tapered walls shall be measured net as walls and extra payment shall be allowed for making tapered surface for brick work in walls. Brick work with brick tiles shall be measured and paid for separately.

The rate shall include the cost of materials and labour required for all the operations described above except the vertical reinforcement and its encasement in cement mortar or cement concrete. The rate shall also include the following: -

- Raking out joints or finishing joints flush as the work proceeds;
- Preparing tops of existing walls and the like for raising further new brick work.
- Rough cutting and waste for forming gables, splays at eaves and the like.
- Leaving holes for pipes up to 150 mm dia. and encasing hold fasts etc.
- Rough cutting and waste for brick work curved in plan and for backing to stone or other types of facing.
- Embedding in ends of beams, joists, slabs, lintels, sills, trusses etc.
- Bedding wall plates, lintels, sills, roof tiles, corrugated sheets, etc. in or on walls if not covered in respective items and
- Leaving chases of section not exceeding 50 cm in girth or 350 sq. cm in cross-section.
- Brick on edge courses, cut brick corners, splays reveals, cavity walls, brick works curved on plan to a mean radius exceeding six meters.

8. Method of Bonding with RCC Frame

All brick masonry walls shall be bonded with the column of the R.C.C frame by providing ¼" dia. Reinforcement protruding out of the column at every 12". The length of the bonding bars shall not be less than 12" with a hook of 1" dia. at the end and allowed to extend out through the holes provided in the form works for the column.

7.16.1.2 Brickwork with Hoop Iron

7.16.1.2.1 Material and Construction Requirements

In partition walls 3 inches or 4½ inches thick a reinforcement of 1 inch wide 18-gauge hoop iron shall be placed in courses not more than 12 inches apart and continued for 9 inches into the main wall on which the partition wall abuts. If the partition wall exceeds 20 feet in length or 15 feet in height the hoop iron shall be introduced at courses not more than 6 inches apart. In respect of materials, workmanship, curing and protection, it shall conform to the 7.3.1 Specifications for Brickwork First Class.

7.16.1.2.2 Measurement

It shall be measured by the superficial area. The unit of measurement shall be 100 square feet.

7.16.1.2.3 Rate

1. Labor Rate

The Unit rate (on labor rate basis) for brickwork with hoop iron shall include cost of carrying out brickwork, cutting bricks whenever required, curing and protecting as per above Specifications and/or any other Specifications specially included in the contract. It shall further include the cost of providing, using and removing scaffolding, shuttering, centering, slagging, ladders, supports and other tools and plants required for carrying out brickwork with hoop iron as per above Specifications.

2. Composite Rate

The unit rate shall include the cost of bricks, hoop iron, mortar, tools and plants and any other material required, in addition to the labor rates detailed above in section 7.16.3.1.

7.16.2 Clay Brick Partition Walls

- The blocks which should be used for clay brick partition wall, shall manufactured from clay or terracotta and either solid or hollow.
- Hollow clay bricks should commonly employ for light partition wall.
- Hollow brick partition walls are rigid, economical, strong, fire resistant, and good heat sound insulator.
- Hollow clay blocks of section 30x 20 cm with thickness varying from 5 cm to 15 cm should be used.
- Hollow brick partitions walls should be constructed in similar manner as structural load bearing walls.
- Grooves should be provided on top, bottom, and sides of block to improve the bond between the block and plaster.

7.16.3 Concrete Partition Wall

It shall consist of concrete slab, plain or reinforced, supported laterally by vertical members. These slabs shall be either precast or cast in situ.

1. Cast in Situ Concrete Partition Wall

- Thickness shall range from 80mm to 100mm
- It shall be poured monolithically with intermediate columns
- It is rigid and stable both in vertical and horizontal directions but the framework is costly.
- The reinforcement consisting of mild steel bars or B R C fabric should be placed in the center of the wall thickness.
- Concrete mix usually adopted in the work should M15 (1:2:4).

2. Precast concrete slab partitions wall

- The wall should be built from precast concrete slab units
- Precast unit thickness shall range from 25mm to 40mm
- Precast units should be secured to precast posts
- Joints shall be filled with mortar
- Concrete mix should be M15 (1:2:4)

7.17 Cavity Wall

7.17.1 General

It is a wall comprising of two leaves, each leaf being built of masonry units and separated by a cavity so as to provide an air space within the wall and tied together with metal ties or bonding units to ensure that two leaves act as one structural unit. The width of the cavity shall not be less than 50 mm and not more than 115 mm. Each leaf of the cavity wall shall not be less than 75 mm. The space between the leaves either left as cavity or filled with no-load bearing insulating and water proofing material.

7.17.2 Materials Requirements

The bricks shall be first class bricks specified in this Section. The mortar shall be cement sand mortar as specified below: -

Cement mortar shall consist of one-part Portland cement to specified number of parts of dry loose sand (Fine aggregate) by volume and sufficient water to produce proper consistency for intended use. Waterproofing agent not exceeding 25% by volume of dry cement shall be added when specially required or directed by the Engineer-in-Charge.

The laying of bricks masonry for cavity walls shall comply to following provisions: -

- For single segmental arch, centre shall be struck immediately after the arch is finished.
- For series of segmental arches, centre of each arch shall be struck as soon as the arch is succeeding it is completed.
- For semi-circular, elliptical or pointed arches, centre shall be struck as soon as brickwork has reached two thirds the height of such arches.

The centring and shuttering for the arch shall be as approved by the Engineer-in-Charge before the arch work is started. It shall be strong enough to bear the dead load of the arch and the live loads that are likely to come upon it during construction, without any appreciable deflections. The shuttering shall be tightened with hard wood wedged or sand boxes, so that the same could be eased without jerks being transmitted to the arch. The sequence of easing the shuttering shall be as approved from the Engineer-in-Charge. The shuttering shall be struck within 48 hours of the completion of the arch but not before 24 hours. This shall be done after the spandrel has been filled in and the arch loaded.

The length of the arch shall be measured as the mean of the extrados and intrados of the arch correct to a cm. The thickness of the arch shall be measured in multiples of the half brick.

- The breadth in the direction of the thickness of wall shall be measured as specified.
- The cubical contents shall be calculated in cubic meter, correct to two places of decimal.
- For arches exceeding 6 m in spans extra payment shall be made on the actual area of the soffit for additional cost of centring including all strutting, bolting, wedging, easing, striking and its removal.

Curing and scaffolding shall be as given below: -

The brick work shall be constantly kept moist on all faces for a minimum period of seven days. Brick work done during the day shall be suitably marked indicating the date on which the work

is done so as to keep a watch on the curing period. Scaffolding shall be strong to withstand all dead, live and impact loads which are likely to come on them. Scaffolding shall be provided to allow easy approach to every part of the work and safe working.

- 1.5" thick thermophore sheet having density not less 30 kg/m³ for insulating purposes

7.17.3 Construction Requirement

7.17.3.1 Metal Ties

These may be of galvanized iron, wrought iron, gun metal, brass, copper, stainless steel or any such corrosion resistant metal, made of flats 20 x 5 mm cranked or twisted at their mid-point with ends split and fish tailed. The ties shall be built into horizontal bed joints during erection, placed sloping towards the exterior side to prevent water from flowing along it from outer to inner leaf side.

7.17.3.2 Bonding Units

Length of the Bonding units will be sum of thickness of both leaves plus width of cavity if the leaves are 75 mm or 115 mm. If the leaves are more than 115 mm thick, then the length of a unit will be: -

$$[(2 \times 115) + \text{width of cavity}]$$

Cement concrete used in the bonding units shall not be leaner than 1:3:6 (1 cement: 3 sand :6 aggregate 20 mm nominal size).

7.17.3.3 Spacing

Metal ties/bonding units shall be spaced not more than 90 cm apart horizontally and 45 cm vertically and staggered in each course. Additional ties shall be used near openings.

7.17.3.4 Restrictions

Cavity walls shall not normally be built more than 7.5 meters in height and 9 meters in length. Where large lengths and heights are desired, the wall shall be divided into panels with strengthening measures such as pillars etc. Cavity shall be covered at the top with at least two courses of masonry unit and/or a coping over it. Adoption of cavity walls is not recommended when heavy concentrated load from beam etc. are to be supported by walls.

7.14.3.5 Insulation

Contractor will be responsible to insulate the cavity walls with thermophore sheet of specified size having thickness not less than 1" and density not less than 30 kg/m³ as per the BOQ item.

7.17.4 Measurements and Rate

- Brick work in cavity walls shall be included and measured with general brick work. The width of the cavity shall not be measured. Skin of cavity wall, half brick thickness shall be measured as and paid as described in 7.16.1.1(7).

- The forming of the cavity shall be given in square meters stating the width of the cavity and shall include the metal ties/bonding unit specifying the numbers per square meter.
- Labour and material for closing cavities at the jambs, sills and heads of opening shall be as described and measured separately in running meters.
- The item shall include use of device for keeping cavity clear and forming the requisite weep and vent holes and nothing extra on this account shall be payable

7.18 Construction with Seismic Consideration

7.18.1 General

Foundation of a building is the part of the building below the ground level. The purpose of the foundations is to transfer the load of the construction to the ground. The weight of the structure must be suited to the load capacity of the ground which in turn shall be stable. The structure must also be correctly joined and anchored to the foundations. Generally stepped strip footing should be adopted for load bearing wall construction.

7.18.2 Width of foundation

The width of foundation should be sufficient so that soil is able to bear the weight of the building without excessive settlement. If the foundation soil is soft, the width of foundation should be more. Similarly, if the building weight is more, the foundation should have a greater width. A minimum width of 2'-6" is suggested for single storey construction.

7.18.3 Materials of foundation

Mud or mud bricks are not strong enough to resist earthquake forces at the foundation level. It is recommended that the foundation should be preferably built by using dressed stones, burnt clay bricks or concrete blocks. A 3" to 6" thick pad of lean concrete shall be provided under the foundation. The concrete mix proportions for this pad shall be 1:4:8 (one-part cement, four parts sand and eight parts crushed aggregates).

7.18.4 Depth of foundation

The depth of foundation below existing ground level should be at least 3'-0" for soft soil. For Rocky ground the depth of footing may be reduced to about 1' -6".

7.18.5 Typical Foundations

The following figures present suggested foundation details for stone masonry, brick masonry and concrete block masonry load bearing walls for single storey construction. For double storey construction the width shall be increased by one foot (1 Ft). The depth of foundation shall be reduced for rocky grounds.

- Stone Masonry Foundation
- Brick Masonry Foundation
- Concrete Block Masonry Foundation

In case of loose soil, provide some nominal reinforcement in foundation bed concrete. If stone soling is used under foundation reduce the thickness of foundation strip to 3". The vertical steel bars indicated in the foundations are to be provided at corners and junction of walls.

7.18.6 Plinth Masonry

7.18.6.1 Recommended Construction

The plinth masonry should preferably be constructed using stone or burnt bricks laid in cement mortar. Cement mortar or lime mortar is stronger than mud mortar in binding the stones or bricks in the wall together to resist earthquake forces.

7.18.6.2 Height of Plinth

The height of the plinth should be above the flood water line or a minimum of 300 mm (1 ft) above ground level. Wherever possible the height of plinth shall not be more than 2'-6". Where higher plinths are required the thickness of walls below plinth shall be increased.

7.18.6.3 Waterproofing and Drainage

Water makes the foundation soil weak. In an area that experiences rainfall or snowfall, it is recommended to use a waterproofing layer at the plinth level before starting the construction of wall above the plinth and provide an apron and drain around the house to prevent runoff water that might wet walls or enter the foundation.

7.18.7 Walls

Although a lot of wall construction materials are available, however, one goal of this guideline is to promote local materials: -

- Concrete
- Blocks/bricks/dressed stones
- Brick that are over burnt, under burnt and deformed shall not be used.
- Quarry stones that are solid with no obvious fractures shall be used.
- Boulder stone shall never be used in its natural shape. These boulders should be dressed or semi-dressed before they are laid. Small boulder stones up to 6" may be used by casting them in the shape of large concrete block.
- Solid block (concrete or stone) shall be of regular shape, preferably free from broken edges, any type of deformation and cracks. Normal acceptable mix is 1:3:6 (cement: sand: 10 mm down coarse aggregates). Curing of these units for a minimum of seven days shall be done.

7.18.8 Joints

All joints should be raked and faces of wall cleaned at the end of each day's work. On faces to be plastered, joints shall be raked to 20 mm depth. Vertical joints of consecutive course should not come directly over one another. Mortar joints shall have uniform thickness and should not exceed 6mm (1/4") and should be fully filled with mortar. Brick must be lightly mortared on side before laying. Dry or butt joints shall not be used or made.

7.18.9 Seismic Strengthening Measures

7.18.9.1 Horizontal Seismic Band

Horizontal seismic bands should be provided at different levels of a wall. A seismic band should be continuous beam that binds, reinforces and makes all parts of the wall at the level of the band to act together. The seismic bands should be provided at three levels. These bands should be well bonded together at the corners.

7.18.9.2 Plinth Band

Plinth seismic band is provided at the plinth level. Where a stone plinth or burnt-brick plinth is constructed, a reinforced concrete plinth band may be used. In that case a separate damp proof course will not be necessary. Plinth band is necessary in a building that is resting on soft soil foundation.

7.18.9.3 Lintel Band

Lintel seismic band should be provided at the top level of doors and windows, monolithic with the lintels of doors and windows. The lintel seismic band shall be made of reinforced concrete. When the height of the wall is not more than 2.5 m, the lintel band may be merged with roof band.

7.18.9.4 Roof band

Roof seismic band or ceiling seismic band should be provided just below the roof. This reinforced concrete band will also serve as wall plate for supporting the roof wooden logs or joists, which should be nailed / spiked to this band for ensuring their stability during earthquakes.

7.18.9.5 Details of Horizontal Seismic Bands at Plinth/Lintel & Roof Level

The horizontal seismic bands in stone/concrete block or brick masonry walls should be provided using R.C.C 1:2:4.

7.18.9.6 Details at Corners and T-junctions for Seismic Bands

The following pattern of steel bars shall be adopted at corners and T-junctions for seismic bands. Seismic bands at the corners and T-junctions must be provided with the following details. In addition to horizontal seismic bands steel dowels shall be placed at corners and junctions at a vertical spacing of 18" to 24". The dowels shall comprise 2 Nos. 3/8" \varnothing , 3ft - 4 ft (900- 1200) long steel bars with 1/8" \varnothing ties at 6" apart. Expanded metal mesh may also be used in place of steel bars and ties. If room sizes are small, dowel bars may be made continuous.

7.18.9.7 Vertical Wall Reinforcements

Vertical reinforcement, in the form of 5/8" F or min. 1/2" F bars for brick and concrete block masonry and 3/4" F or min 5/8" F bars for stone masonry, shall be provided at corners, junctions and around large openings.

7.19 Honey Comb Brick Work/Perforated Brick Masonry

The honeycomb brick work shall be done with specified class of brick, laid in specified mortar. All joints and edges shall be struck flush to give an even surface. The thickness of the brick honeycomb work shall be half-brick only, unless otherwise specified. Openings shall be equal and alternate with half brick laid with a bearing of 2 cm on either side.

7.19.1 Measurements

The length and height shall be measured correct to a cm. Area shall be calculated in square feet correct to two places of decimal and will be paid accordingly. Honeycomb openings shall not be deducted.

Contents

CHAPTER 8	STONE MASONRY	6
8.1	General	6
8.1.1	Definition	6
8.1.2	General Principals	6
8.1.3	Glossary of Terms	6
8.1.2	Stone	30
8.1.3	Mortar	30
8.1.4	Stacking of Stone	30
8.1.5	Tools and Equipment	30
8.1.6	Wetting of Stone	31
8.1.7	Laying Stone Masonry	31
8.1.8	Fixture	31
8.1.9	Lintels and Inside stone	31
8.1.10	Openings	31
8.1.11	Scaffoldings	31
8.1.12	Centering	32
8.1.13	Putlogs	32
8.1.14	Rounded Corner	32
8.1.15	Striking of joints	32
8.1.16	Bed Plates	32
8.1.17	Cramps	32
8.1.18	Protection and Watering	32
8.1.19	Coping and Corners	32
8.1.20	String Courses	33
8.1.21	Measurements	33
8.1.22	Rates	33
8.2	Dressing and Cutting of Stones	34
8.2.1	Description	34
8.2.2	Cut Stone Work	34
8.2.3	Fine Dressed Stone	34
8.2.4	Chisel Dressed Stone	34
8.2.5	Rough Tooled Stone	34
8.2.6	Hammer Dressed Stone	34
8.2.7	Measurements	34
8.2.8	Rates	34
8.3	Ashlar Masonry	35
8.3.1	Scope	35
8.3.2	Stone Dressing	35
8.3.3	Thickness of Joints	35

8.3.4	Size of Stone	35
8.3.5	Bond	35
8.3.6	Through Stone	35
8.3.7	Courses	35
8.3.8	Jambs	35
8.3.9	Other Respects	36
8.3.10	Measurements	36
8.3.11	Rates	36
8.4	Rough Tooled or Bastard Ashlar	37
8.4.1	Description	37
8.4.2	Mortar	37
8.4.3	All other Respect	37
8.4.4	Measurements	37
8.4.5	Rates	37
8.5	Rock Rustic or Quarry Faced Ashlar Masonry	37
8.6	Ashlar Facing	38
8.6.1	General	38
8.6.2	Dressing of Stone	38
8.6.3	Size of Stone	38
8.6.4	Depth of Facing	38
8.6.5	Height of Courses	38
8.6.6	Beds and Joints	38
8.6.7	Bond Stone	38
8.6.8	Measurements	38
8.6.9	Rates	38
8.7	Ashlar Block in Course Masonry	40
8.7.1	Dressing	40
8.7.2	Size of Stone	40
8.7.3	Laying	40
8.7.4	Bond Stone	40
8.7.5	Other Respects	40
8.7.6	Measurements	40
8.7.7	Rates	40
8.8	Ashlar Block in Course Facing	40
8.8.1	General	41
8.8.2	Sizes of Stones	41
8.8.3	Height of Course	41
8.8.4	Beds and Joints	41
8.8.5	Bond Stone	41
8.8.6	Face	41

8.8.7	Mode of Measurements	41
8.8.8	Rates	41
8.9	Copings, Cornices and Columns.....	42
8.9.1	Stone	42
8.9.2	Dressing	42
8.9.3	Size of Stone	42
8.9.4	Mortar	42
8.9.5	Chajjas.....	42
8.9.6	Joints	42
8.9.7	Weathering and Throating.....	42
8.9.8	Dowels	42
8.9.9	Measurements	42
8.9.10	Rates.....	42
8.10	Course Rubble Masonry (1st Class)	44
8.10.1	Height of Course	44
8.10.2	Dressing	44
8.10.3	Thickness of Joints.....	44
8.10.4	Size of Stone.....	44
8.10.5	Through stones and Headers	44
8.10.6	Breaking of Joints	44
8.10.7	Quoins	44
8.10.8	Inferior Face	44
8.10.9	Hearting.....	44
8.10.10	Other Respects	45
8.10.11	Measurements	45
8.10.12	Rates.....	45
8.11	Course Rubble Masonry (2nd Class)	45
8.11.1	Scope.....	45
8.11.2	Other Respects.....	45
8.11.3	Measurements	46
8.11.4	Rates.....	46
8.12	Random Rubble Masonry	46
8.12.1	General	46
8.12.2	Joints	46
8.12.3	Through Stone or Headers	46
8.12.4	Hearting.....	46
8.12.5	Other Respects.....	46
8.12.6	Measurements	47
8.12.7	Rates.....	47
8.13	Dry Rubble Masonry	47

8.13.1	Size of Stone	47
8.13.2	Beds	47
8.13.3	Bond Stone	47
8.13.4	Filling	47
8.13.5	Measurements and Rates	47
8.14	Stone Masonry in Arches	48
8.14.1	General	48
8.14.2	Cutting, Dressing of Stone	48
8.14.3	Centring	48
8.14.4	Wedges and Sand Boxes	48
8.14.5	Building of Arches	48
8.14.6	Through Stone	49
8.14.7	Size of Stone	49
8.14.8	Breaking Joints	49
8.14.9	Measurement and Rate	49
8.15	Dhajji Walls	50
8.15.1	Timber	50
8.15.2	Framework sills Bresseumers Posts	50
8.15.3	Horizontal Pieces	50
8.15.4	Diagonal Bracing	50
8.15.5	Doors and Windows Separate Chowkats	50
8.15.6	Without Chowkats	50
8.15.7	Protection from Damp Ground	50
8.15.8	Paint with Wood Preservatives	50
8.15.9	Iron Fastenings	51
8.15.10	Filling	51
8.15.11	Filling to the Tight	51
8.15.12	Inner Walls to be Plastered	51
8.15.13	Finishing of Outer Walls	51
8.15.14	Measurements	51
8.15.16	Rates	51
8.16	Stone Revetment of Pitching	52
8.16.1	Types of Stone	52
8.16.2	Profile	52
8.16.3	Sub grading	52
8.16.4	Thickness	52
8.16.5	Laying	52
8.16.6	Boulder Pitching	52
8.16.7	Size of Boulder in Grouted Pitching	52
8.16.8	Laying of Boulders	52

8.16.9	Grouting in Boulder Pitching	52
8.16.10	Measurements	52
8.16.11	Rates.....	53

CHAPTER 8 STONE MASONRY

8.1 General

8.1.1 Definition

Stone masonry is the art of building in stone. In order to reduce expenses involved in the cutting and dressing of stone, only the face stones are dressed. The interior or hearting is made up with smaller stones roughly positioned with a hammer or backed up with concrete or brickwork. In most of the cases, stones of varying dimensions are used, which makes it a matter of great skill to obtain a proper bond in the work. Owing to the irregular shape of materials the walls have also to be built considerably thicker than walls of the same height in brick, except the walls made of fine dressed coursed stones. The large dimensions, in which stone may be obtained, render it superior to brick for a building of architectural value and make it possible to have cornices of great projection and other bold features characteristic of classic styles. The comparatively large size of the blocks gives scale to the subject, which is destroyed by the numerous joints inevitable with brickwork. It requires considerable experience to determine the appropriate size of blocks of stone to be used in a certain position and to ensure that they will conform to the general scale of the building. For instance, very small stone used in the plinth of a huge building would look shabby and ridiculous.

8.1.2 General Principals

Usually stones have a granulated structure and a low tensional and shearing resistance. They should, therefore, always be laid keeping the following points in view:

1. That they resist compressional stresses.
2. That they have their laminae at right angles or thereabouts to the pressure.
3. That with side thrusts. The mass of stone must be so disposed that its weight when compounded with the thrust will give a resultant that will fall within the middle third of the bed joint.
4. That eccentric vertical loads such as from ends of beams should always have their center of pressure within the middle third of the wall to avoid tensional stresses.
5. That laminated stones should never be laid with their laminae planes parallel to the face of the wall, otherwise there is a danger of scaling.

8.1.3 Glossary of Terms

A list of terms covering the entire field of stone masonry grouped up in separate sections is as follows:

8.1.3.1 Tools Employed

Archimedean Drill:	A tool in which a to-and-fro axial movement causes a boring tool to rotate.
Axe:	A mason's tool with a head of hard tempered steel which is tapered to an edge on both ends and fitted with a wooden handle.

Banker:	A bench made of heavy timber or blocks of stone on which a stone is set at a convenient height for the mason to dress.
Batting Tool / Broad Tool:	A Chisel usually having a width of 3 inches to 4¼ inches used for 'batting' or making a fine tooled finish.
Bevel / Shifistock:	A tool used for obtaining and testing angles and for working chamfers.
Boaster / Drove / Bolster:	A broad-faced chisel used for dressing a stone to a comparatively smooth surface.
Bob / Centre Bob:	A pendant used to determine the position of a point vertically below a datum point.
Box Trammel:	A tool used for scribing parallel or concentric lines on circular work or positioning working points and depths at right angles to a face or in sinking.
Brace:	A tool used to rotate a boring tool, or a bit used for drilling holes in stone and marble.
Bull set:	A tool set on a shaft and used in the granite industry for dressing off unwanted material. After the cutting edge is positioned on the stone, the head is struck with a sledge hammer.
Carborandum Saw:	A circular saw in which the steel disc is rimmed with Carborandum (see 'Circular saw').
Chain Saw:	A power-driven saw consisting via chain, which has cutting tips, attached to the links.
Chisel / Hammer	A steel tool, having a plain shaft, with a cutting edge having a width
Headed Chisel:	varying from ½ inch to 1½ inch used for drafting or chiseling granite and hard sandstones.
Chop Axe:	A heavy axe used for chopping off the rough surface of stone before dressing.
Circular Saw:	A machine with a power-driven revolving steel disc to the rim of which abrasive elements are attached.
Claw-Chisel:	A tool, usually having a width of 1½ inch to 2 inches, used in conjunction with a mallet in making drafts over a stone surface the teeth being formed to prevent the stone plucking or lifting in holes.
Cock's Comb:	A thin gauge steel plate with a serrated edge (resembling the shape of a cock's comb), used for scribing around a zinc templet

on stone and also for combing a very fine surface to moulded stone work, see also 'Drags'.

Coulter-Machine /	A power-driven machine similar to a 'planer', but capable of being
Canting-Arm Machine:	set at an angle.
Cross-Cut Saw:	A tool used for sawing large blocks of stone into smaller sizes.
Cup-Headed Tools:	Chisels of various sizes used in conjunction with an iron hammer, chiefly for letter cutting and carving.
Diamond Saw:	A circular saw in which the steel disc is rimmed with industrial diamonds. It is used for fast cutting of hard stone.
Dolly Point:	A four-pointed bit used in a pneumatic tool or dunter.
Double Sinking Square:	An instrument used when squaring stones to shape to test the accuracy of the surfaces that are intended to be at right angles to each other. It is usually made of steel throughout but the stock is often of hardened brass. The main blade passes through a slot in the stock with a thumb screw in the top of the stock to hold the blade in the required position. An attachment at the other end of the main blade holds a secondary blade parallel to the stock, which can also be adjusted by a thumb screw to the required depth.
Drafting Chisel:	A wood-handled tool used in conjunction with a dummy for working drafts.
Drags / Combs / Circular Die:	Tools used for finishing the surface of soft stones. They are made of plate steel varying in thickness from 8 B.G. for 'coarse' to 18 B.G. 'fine' and are half elliptical in shape with teeth on the straight edge, varying in length up to 8 inches. They have 4 to 5 teeth to an inch for coarse, 8 to 10 for 'second' and 16 to 20 for 'line'. Fine drags are made in many different shapes to fit various moulding. Circular drags are similar to the above, but have toothed edges of various convex curves for finishing circular work.
Driver:	A chisel having a width of 1½ inch to 2 inches, with a shank which passes into a wooden handle, used with a mallet for dressing soft stone to a comparatively smooth surface.
Dummy:	A mallet having a head made of zinc or lead for use with wood-handled chisels.
Dunter / Surfacer:	A tool used in the granite industry for mechanically dressing large surfaces. It comprised an arm, capable of movement over the surface of the stone, carrying a percussion toll actuated by compressed air.

Feather:	See 'Plug and feathers'.
Fillet Chisel / Spindle:	A chisel having a width varying from 1/8 th of an inch to ½ inch, used for working details and enrichments.
Fillet Rasp / Riffler Rasp:	A steel file having serrated edges for working off a stone to fine limits.
Fillet Saw:	A small saw having an adjustable handle for sawing down near to a line for fillets and similar details.
Frame Saw:	A power-driven machine having a swinging or reciprocating frame into which one or more blades may be set at variable intervals. It is used for cutting blocks of stone, marble, granite or slate into slabs of various thicknesses. Its blades are made of steel and the actual culling is done by feeding abrasive with water, into the cut.
Frig-Bob Saw:	A steel-toothed saw, 5 feet to 7 feet long, having a handle at one end.
Gouges:	Tools of various sizes and curves for use in working Mouldings to their required shapes. Steel gouges are used with a mallet. For soft stone a gouge with wooden handle is used with a dummy.
Jenny Lind:	A power-driven machine having a head, consisting of a metal plate rotating on a vertical axis, which can either be fed with an abrasive or can have Carborandum or other pads fixed to it. The head can be moved freely over a horizontal surface on the pantograph principle. The machine is used for rubbing and polishing slabs of stone, marble or granite.
Jumper:	A hand tool used for sinking holes in stone.
Lathe:	A machine in which a piece of stone, marble, granite or other material can be rotated on a horizontal axis. It is used for shaping stone into various sizes that can be turned, such as columns and circular moulded work, and for rubbing and polishing surfaces.
Lewising Chisels:	Tools, ¾ inch to 1¼ inch wide, formed specially to cut mortices for the insertion of lewises for lifting stone
Lump Hammer	A mason's cast steel hammer weighing from 2 to 5½ lbs.
/ Mash Hammer:	
Mallet:	A tool made of hickory or beech wood and used by the mason as a hammer when working with certain steel chisels, gouges and the like.

Mallet Headed Chisels, Gouges, Point and Wasters:	Steel tools having domed heads for use with a wooden mallet to work stone to various profiles.
Molding Machine:	A power-driven machine used for running Mouldings through stone. They are of two distinct types. One employs an abrasive moulding wheel, and the other is steel tools.
Molding Wheels:	Discs with abrasive rims shaped to the reverse of the moulding desired.
Patent Axe / Bush Hammer:	A tool having 4 to 10 thin blades of steel ground to an edge and bolted together on the handle. It is used for finishing granite or hard stone. The number of blades affects the fineness of the finish.
Patent Claw Tool / Tooth Tool:	A tool made of steel and similar to a steel chisel but having a clawed (toothed) removable cutting edge which fits into a slot at the base of the handle. The cutters can be changed and are of varying widths up to 2 inches.
Pick:	A tool made of hard tempered Steel, tapered to a point at one or both ends and fitted with a wooden handle about 18 inches long.
Pitching Tool:	A tool similar to a large chisel but having a blunt edge in place of a sharp edge.
Planer:	A power-driven machine used for planning or running Mouldings through stone or other material.
Plug and Feather:	A steel wedge (plug) used with a pair of half round steel strips (feathers) on either side. Note - Blocks of stone are cloven by drilling a line of shallow holes, inserting a pair of feathers and a plug in each and driving home the plug with a hammer.
Plumb-Rule:	A wooden straight edge having a plumb line attached to it.
Pneumatic Hammer:	A percussion tool driven by compressed air and used for working stone, marble and granite.
Point / Clourer:	A steel chisel drawn to a point and used for taking off the rough stone to make an approximately plane surface.
Punch / Hammer Headed Puch:	A steel chisel drawn nearly to a point and used tor shaping the rough stone before tooling.
Quarryman Axe:	A double-bladed steel axe, approximately 14 lb. in weight used for scabbing rough block shine to square dimensions.

Quirking Tool:	A tool similar to the lewising chisel. It has a width of 3/8 of an inch to ¾ of an inch, and is used for cutting grooves in sills, grooves for lead flashings, and the like.
Rubbing Table:	A flat, circular table, having a cast iron top which rotates slowly on a vertical axis, on which stone, marble or granite can be rubbed to a fine finish.
Seabbling Hammer:	A hammer that has one end pick pointed; it is used for roughly dressing granite or hard stone.
Spall Hammer:	A hammer having a concave end, forming two cutting edges used for removing superfluous stone.
Splitter:	A hammer headed tool, 3 to 4 inches wide, having a cutting edge approximately 1/16 of an inch thick.
Templet / Template:	A pattern of wood or metal cut to a required profile and used to outline a shape for cutting and to gauge the profile as the work proceeds.
Tracer:	A large chisel used for tracing a shallow groove along a series of plug holes to assist in the splitting of a mass of rock.
Trammel and Scriber:	A tool used for scribing parallel lines.
Trammel Points:	Metal points used in conjunction with a wooden beam to strike large circles.
Vertical Polisher:	A mechanically-driven vertical shaft having a universal joint, terminating in a disc to which abrasive elements can be fed or fitted.
Whip Saw:	<p>A narrow saw of flexible steel, 2½ feet to 4 feet long and 1 inch to 2 inches wide, having 4 to 5 teeth to an inch and a wooden handle at each end in the line with the blade. It used for sawing around curves.</p> <p>Note - The whip saw is specially used for tracery work and one handle is sometimes made detachable to allow the blade to be threaded through small openings.</p>
Wing Compasses:	Compasses having a thumb screw which works against a quadrant bar so that the spacing of the points can be fixed.

8.1.3.2 Surface Finishes

Selection of Surface Finish: The proper finish to be used depends upon the type of masonry, the kind of stone, its position and use in the building, the architectural effect desired, atmospheric conditions and the money available.

All the types of finish described above may be used on granite and marble and, with the exception of polishing, may be used

on sandstone and limestone. Limestone which can be polished is usually classified as marble. Hammered finishes are suitable only for harder sandstone and limestone because on softer stones the ridges will not stand up but will break off leaving a bruised face. These finishes are, therefore, often called hard stone finishes. Tooled finishes are similar to hammered finishes and are more suitable for soft stones. In selecting a finish, the type that will give the desired results at the least cost would naturally be used. Very satisfactory results are often produced at low cost with quarry, seam or split face rubble masonry.

In general, rubble masonry will be quarry-face or hammer dressed; square stone masonry will be quarry-face or pitched face or hammer dressed; ashlar or cut-stone masonry will have a pointed face if granite is used, and a sawed, smooth, or rubbed face if limestone or sandstone is used. Marble will usually be rubbed or honed for exterior use, and either honed or polished for interior use. A quarry face or pitch face may also be used for ashlar. On account of the ease in cleaning, polished surfaces are often used for base courses and other parts which may be splashed with mud by the passing vehicles and for lower stories exposed to a smoky atmosphere. The finer finishes remain clean longer than the coarse finishes. The sawed finish is the cheapest finish for limestone and sandstone, except the harder grades. The standard finish for limestone is the smooth finish. Machine tooled finish is usually four, six, or eight bats to an inch. Two-bat tooling may be used on large scale work, and ten-bat tooling when an especially fine tooling is desired. Hand pointed finishes are often used on limestone as well as on sandstone and granite. The finer finishes are more suitable for use on interior surfaces than the coarser finishes; but since on Mt: exterior the finer finishes will not show if used above the first story, the cheaper finishes are more suitable.

**Angle tooled
/Angle Dressed:**

Stone dressed so that the tool marks run diagonally across the face.

Axed:

A patent axe or a bush hammer having a surface obtained by using an axe. A surface is said to be 'fine axed' when it has been chopped with fine axe marks. 'Once-axed' is the term used for rough chopping of a surface with an axe.

Batted (Broad Tooled):

A surface having been obtained by using a batting tool in parallel strokes each traversing the full depth of the stone face. The strokes may be vertical, when it is often referred to as tooling or oblique at an angle of 45° to 60°. The result is a regular pattern of fluted cuts in the stone face. The number of strokes per inch may vary from 8 to 10.

Blocking cut:

Roughly shaping a slab or stone.

Boasted / Drovod:	A stone finished by dressing with a boaster.
Boasted for Carving:	Reduced by rough dressing, usually with a point tool, to approximately the form required by a sculptor.
Broached (Drovod):	Worked with a point to show diagonal or horizontal furrows.
Drafted Margin:	A tooled margin, $\frac{3}{4}$ of an inch to 2 inches wide, worked on the face of a rough squared stone.
Hammer Dressed / Bull Faced:	Having a rough face prepared with a hammer.
Joint Bedded:	A stone cut with the laminae running vertically and parallel to the joints.
Moulded:	Cut to the profile of a moulding.
Picked / Pecked / Sparrow Pecked:	A dressing obtained by means of a point tool or a pick.
Pitched:	A surface produced by a pitching tool to resemble to the natural rock face.
Polished:	Having a high-gloss mirror-like finish. It is also synonymous with the term 'rubbed' used for stones.
Surface Finishes	Various types of surface finishes are as below:

a) Quarry Face or Rock Face

It is the original face of a stone when it comes from the quarry. It may be formed by quarrying operations, or may be a natural seam. In the latter case it is known as a seam face. Quarries producing seam face stone are traversed in all directions by natural seam forming relatively small blocks of stone of irregular shape and size. Seam faces are often highly colored by deposits from mineral laden waters which have penetrated into the seams. It is employed in pitching, dumping, retaining walls, etc.

b) Hammer Dressed or Scabbled Face

Scabbling mean taking off the irregular angles of stone with the scabbling hammer. That is usually done at the quarry, and the stone is then said to be quarry pitched, hammer faced or hammer blocked. If, after scabbling, the face of stone is roughly dressed also by Waller's hammer, the finish is called hammer dressed face. Hammer dressed faces are commonly used on granite and harder limestones and sandstones but are not suitable for softer varieties of limestone. This type of stone is used in rubble masonry or stone pitching.

c) Rough Tooled Face

Rough tooled (also called one-line dressed face) is sparrow pitched or chisel dressed. No portion of the dressed face is more than ¼" from a straight edge placed on it. It is analogous to rough or coarse pointed finish. This sort of finish is usually employed to give a bold appearance to quoin and plinth stones and where so used, it usually has a chisel drafted margin about the perimeter.

d) Chisel Dressed Face

Chisel dressed face (also called two-line dressed face) is again sparrow pitched or chisel dressed. No portion of the dressed face is more than 1/8 inch from a straight edge placed on it. It is analogous to medium pointed finish. This is usually employed in quoins and jambs for doors and windows or in ashlar masonry.

e) Fine Dressed Face

This is a superlative degree of tooled finishes. (It is also called three-line dressed face). It is the best finish which can be given to a stone with chisel and other dressing tools without rubbing. A straight edge laid along the face of the stone so dressed, remains in contact with the surface at every point.

f) Sawed Finish

It is the surface produced by the saws in cutting a stone to size. The marks of the saws are visible.

g) Smooth Finish

It is produced by planers without hand work except the removal of objectionable tool marks.

h) Rubbed Finish

It is obtained by rubbing the surface of stone till it becomes perfectly regular, and it also as smooth as possible. The work is done by hand by rubbing a piece of stone with another. During the first stages of the process, water and sand are added; gradually the quantity of sand is reduced. Large quantities of stone are machine rubbed by means of large horizontal revolving iron discs. The stones are placed on and kept from revolving with the disc by means of stationary timbers fixed across the table a few inches above the stone. No pressure other than the weight of the stone is applied. Water and sand are added to accelerate the process. Only plane surfaces can be rubbed in this way.

i) Polished Finish

Marbles, granites and many limestones, after being worked to a smooth surface, are often polished. Polishing by manual labour is an exceedingly tedious job. The polishing of marble by hand is done by using rubbers and pads, sand and water, pumices, snake stone and putty powder. The polishing of marble sawn-cut slabs can also be done by machines.

j) Drafted Face

The margin or border of a stone may have one type of finish and the remaining area another type, a tooled margin with the remainder of the surface roughly dressed by hammer. Stones finished in this fashion are called drafted stone.

k) Sand blasting Face

Even fine-grained surface obtained through sand blasting.

Mouldings:

Mouldings of various profiles are worked upon stones for producing ornamental effect, both by hand and by machine. When done by hand the profile of the moulding is marked on the two ends of the stone to be treated by means of a point drawn about the edge of a zinc mould, cut to the profile. A draft is then sunk in the two ends to the shape of the required profile. The superfluous stuff is cut away with the chisel and the surface between the two drafts tested for accuracy by means of straight edges.

The machines for this work somewhat resemble the planing machines for woodwork. The stone is fixed to a moving table which gives the stone a reciprocating rectilinear motion, pressing against a fixed cutter of the shape of required profile or some member of it. The cutter is moved nearer the stone after each journey, thus gradually removing the superfluous stuff till the profile is completed.

Moulded work, strictly speaking, is the name given to profiles formed with a change of curvature and, therefore, should not be applied to cylindrical sections such as columns. The weathering properties of stones moulded by hand are considered by some to be far superior to those worked by machine because in the latter method, the moulding irons, occasionally being driven continuously become heated and partially calcine the surface of the stones. This action renders the stone peculiarly susceptible to atmospheric deterioration. However, if reasonable care is taken to keep the tools cool (by water feed pipes), the method is preferably since it eliminates the stress in the stone caused by the jarring of the hand-driven tool.

8.1.3.3 Handling Equipment for Stone**Chain Tackle:**

Pulley blocks having an endless chain used for hoisting stone.

Dogs and Chains:

A pair of steel hooks, having rings attached to it, into which a chain is slung so that a vertical pull on the chain draws the hooks together in a horizontal direction, thus gripping the stone.

Lewises / Chain Lewis:

Two curved steel legs inserted back in a mortice cut in the top of a stone, and connected together at the top by three rings in such a way that a direct pull causes the legs to spread at the bottom and grip the sides of the mortice.

- Lifting Pins / Pin Lewis:** Steel pins approximately an inch in diameter and about 9 inches long having an eyelet at the end with a ring attached, used in pairs for lifting stone into position. The pins are inserted into inclined holes drilled in the stone, and are connected by a lifting chain.
- Three-Legged:** Two wedge-shaped steel legs separated by a removable rectangular section, the whole connected at the top by a shackle and pin. The wedge-shaped sections are inserted separately into a dove-tailed mortice cut in the top of the stone. The center section is then inserted and the shackle and pin assembled so that the stone can be lifted by a pull on the shackle.
- Rolls Lewis:** A lighter type of three-legged Lewis for lifts up to 25 cwt.
- Nibs:** Small projections left on the faces or sides of a worked stone in which dog holes can be cut for lifting the stone into place. The nibs are worked off after positioning the stone. (Note - A prominent projection from the general face of marble dressings is sometimes call a Nib.)
- Shears, Snips, Scissors:** A device, similar in shape to tongues or scissors, used to grip the ends of a stone in the same way as chain dogs.
- Silver:** Thin strips of steel, approximately 5/8-inch wide, used to pack a badly fitting 2-leg or 3-leg Lewis hole to ensure safe hoisting.
- Sling Chain:** Chain passed round a stone and attached to the lifting apparatus.
(Note - The arises of the stone should be protected by wooden slates.)

8.1.3.4 Fixing Stone in Position

- Anchor Bolt:** A T-shaped bolt for attaching fascia and similar stones to a supporting R.S.J. The arms of the 'T' engage in mortices cut in the joint faces of the stone, and the threaded end of the bolt is inserted in a hole drilled in the R.S.J. and fitted with washer and nut.
- Cement Joggle / Grout Nick:** A V-shaped sinking in the side joint of each adjacent stone in the same course. After fixing, two sinking's together form a rectangular hole, which is filled with cement grout in order to prevent lateral movement.
- Centering:** A temporary wooden structure on which arches are built.
- Corbel Plate:** A metal plate let into and projecting from the backing to provide support for facing slabs.
- Cramp:** A short length of metal or slate suitably bedded into sinking's cut in stones; It is used to tie stones to one another or to their backing.

Dowel / Slate Dowel:	A short piece of metal or slate bedded in sinking's cut in the joint faces of adjacent stones to prevent independent movement of the two stones.
Fixer Bedding:	Lime putty used by fixers.
Grout:	Liquid mortar consisting of cement and sand.
Hollow Bedded:	Blocks set with mortar at the ends only. The center portion is left hollow to guard against breakage in case of settlement.
State Cramp:	A piece of slate, approximately 2"x7"x1". It is generally used in flat coping stones and cut to a double dove-tail form. It is embedded in Portland cement in sinking formed to receive it.
State Joggle:	A small piece of state left into a vertical joint and into the top bed of the stone below to prevent independent movement of stones.
Slurring:	Protection of the finished surface by coating with a weak mix of lime and stone dust to prevent staining. This slurry is washed off on completion of the job.

8.1.3.5 Architectural and Engineering Terms

Abutment:	The solid structure at the extremity of an arch or beam.
Apex Stone:	The top stone of a gable, spire or pediment.
Arch:	A method of spanning an opening with masonry consisting of a series of wedge-shaped stone, known as voussoirs or arch stones which are supported by lateral pressure induced across the radial joints.
Flat Arch:	An arch in which voussoirs or arch stones are arranged to provide a horizontal soffit.
Joggled Arch:	An arch in which adjacent stones are interlocked by means of rebates or tongues and grooves.
Skew Arch:	An arch whose face is not at right angles to its support.
Squinch Arch:	An arch built across an internal angle, such as across that of a square structure, to support on side of an octagonal spire rising from the structure.
Stilted Arch:	An arch having its springing line higher than the line of the impost.
Arris:	The line or edge made by the junction of two surfaces forming an external angle.
Band Course:	A plain course continued horizontally along the face of a building or structure.
Band Stone:	An intermediate coping stone or stones inserted in a gable between a Springer and the apex and bonded into the gable wall.

Barge:	A projecting stone drip at the base of a chimney stack to throw off water.
Base Course:	The lowest course of a wall.
Batter:	An inward inclination of the exterior face of wall.
Bed:	The lower surface upon which a block of stone rests, and the upper surface which supports the stone above.
Bed Joint:	A horizontal joint in a wall or a radiating joint between the voussoirs of an arch.
Bed Mould:	The lowest moulding or course of a cornice.
Bed Stone:	A large flat stone upon which machines or structural members are mounted or bedded.
Belting:	A course which protrudes from the face of a wall into which it is built, and which may have a convex surface.
Bridsmouth:	A notch cut on the edge of one piece of stone to receive another.
Block Stone:	A stone roughly squared at the quarry.
Blocking Course:	A plain course of masonry over a cornice.
Bollard:	A short strong post (originally intended for holding a hawser).
Breaking Joint:	An arrangement of stones whereby the vertical joints in one course do not coincide with those in the courses above or below.
Bonder / Bond-stone:	A stone whose longer dimension is in the thickness of the wall and which may run right through the thickness of the wall.
Chamfer:	The flat surface formed by planning off the sharp angle made by the meeting of two surfaces. This term is usually applied to stone or wood surfaces, while a 'bevel' refers generally to glass or metal surfaces.
Check:	A sinking either in the form of a rebate or a slot.
Cladding:	Thin slabs or stone or other material used extremely as a non-load bearing covering for the structure of a building.
Clean Back:	The inside vertical surface of a stone which extends through the thickness of the wall and forms a face on the inside.
Closer:	A stone placed in a course to close or fill a gap.
Column:	A free-standing vertical member, usually circular on plan.
Coping:	The topmost course of masonry on a wall, which may overlap the surface to give protection from the weather to the courses beneath.
Saddle Back Coping:	A coping weathered both ways from the center of the section (i.e. twice splayed) and either projecting from the wall and throated on both sides or flushed with the wall on both sides.

Segmental Coping:	A coping with a rounded top.
Wedge Coping:	A wedge-shaped coping. It is higher on the front face to divert water towards the back and has a horizontal bottom bed and a weathered top bed. The coping usually projects beyond each face of the wall, and these projections are throated on both the undersides. Sometimes, the coping projects and is throated only at the back with the front face flush with the face of the wall.
Corbel:	A stone or series of stones which project from a wall and often used as a support.
Corbel Step:	Crow step in a stepped gable.
Crow step:	The stone from which steps are formed in Specifications stepped gable of a wall.
Dressings:	A general term used for all masonry.
Dripstone:	See 'Hood Mould'.
Drum:	One of the stones composing the shaft of a column.
Edge Bedded / Joint Bedded:	A stone cut with the laminae running vertically rather than horizontally. (NOTE - Edge bedding used in the cutting of voussoirs with a view to distributing strain around the arch and so helping to avoid breakage and exfoliation when the static is submitted to the action of time and atmosphere).
Giblet Check:	Rebate in stone work into which a door closes when hung without a frame.
Header:	A stone laid so that its greatest dimension is in the thickness of the wall, c.f. Stretcher.
Hearting:	The infilling which forms the core of a rubble wall.
Hood Mould / Dripstone / Label:	A projecting moulding or canopy over a door or window opening to throw off rain from the walls of the building.
Impost:	The top member of a pier or pillar from which an arch springs.
Inban / Inband:	A quoin or jamb stone short on main wall face and long (for bonding) in return or reveal, c.f. Outban or Outband.
Inband Rybat:	Header stone in a jamb of an opening.
Inbond:	Header on a reveal or return.
Indenting:	The omission of stones to form recesses into which future work can be bonded.
Jamb Stone:	One of the number of stones forming part of the vertical surface at the sides of a door or window opening.

Joggle:	a. A projection on one stone to fit into corresponding recess in another stone. b. Adjacent recesses for filling with cement grout or mortar.
Jumper:	A stone that in face work bonds two or more stones on each side. It is used in squared, uncoursed and sneaked rubble work.
Kerb / Curb Stone:	A stone used as an edging (see 'Curb Stone').
Keystone:	The central stone of an arch.
Kilt:	Slight weathering commonly given to stone steps in the setting.
Kneeler:	A stone bonded into the wall and forming an intermediate length of the coping to a gable end.
Linings:	Thin slabs of stone or other material used internally as a non-load-bearing covering.
Lintel (Head):	A stone which spans, in one piece, the top of an aperture.
Long Stone / Saving:	A relieving arch over a lintel.
Mason's Mitre:	A mitre worked out of a single piece of stone and not forming it joint at the mitred angle as in a joiner's mitre.
Moulding:	Moulding of various profiles and worked upon stones for producing or namental affect, both by hand and by machine.
Mortice:	A sinking in a stone to receive a corresponding projection, dowel, rail, etc.
Mullion:	A vertical member sub-dividing a window.
Outban / Outband:	Quoin or jamb stone long on main wall face for bonding and short in return or reveal c.f. Inban or Inband.
Outbank Rybat:	Stretcher stone in a jamb or opening.
Padstone / Template:	A stone incorporated in the structure to distribute a concentrated load.
Parpend:	A through bond stone faced on both ends.
Pen / Pen-Check / Pend:	A bridemouth rebate.
Perpend:	A vertical joint in masonry.
Pier:	Any load bearing vertical mass of masonry, either isolated or attached to a wall.
Pilaster:	A flat rectangular pillar which projects from a wall.
Pillar:	A free-standing vertical member rectangular or polygonal on plan.
Pinning:	A series of small shallow stones introduced at intervals to make up the height of certain courses, thus giving a chequered effect.
Plinth:	The projecting base of a wall or column.

Plinth Course:	An eaves course, wall head course, or plinth course.
Podium:	A raised platform forming the base of a building.
Quoin:	A stone at an external 'angle of a wall.
Raggle / Ruglet:	A sinking to receive a flashing for the edge of steps.
Regletting / Ragling:	The process of cutting a raggle.
Rebate:	A continues rectangular sinking, along the edge of a stone either to receive window or door frames or another member.
Reprise:	The termination of stone worked to form an internal mitre on a moulding or splay or on weathering.
Respond:	A hair pillar or pilaster corresponding to another or to a pillar opposite to it.
Return:	A change of direction in a wall, member or, moulding.
Returned End:	The termination of stone worked to match the face with an external mitre.
Reveal:	The part of the jamb of a window or door opening which is not covered by a frame.
Ryhat:	Reveal stone, c.f. Inban, Outban.
Saddle:	a. Apex stone to a gable. b. A coping splayed both ways.
Saddle Joint / Half Checked Joint:	A stopped joint in a coping projecting course used to prevent penetration of water.
Scuntion / Scontion Scuncheon:	a. Interval reveal. b. The facing to a reveal behind an out band rybat (q.v.) returns of a pier or pilaster. c. Open finished end of a wall.
Sill / Cill:	The lower horizontal member of window openings and certain external door openings.
Skew:	The sloping dressed stones or coping that finish the top or a gable.
Skewback:	An inclined or splayed surface of an abutment from which an arch spring.
Skew Putt / Club:	The bottom stone at skew supporting a raking, coping or skew above.
Skew, Skew Corbel Slip:	Narrow piece of stone inserted between large blocks.
Slip:	Narrow piece of stone inserted between large blocks.
Soffit:	The under surface of a lintel or an arch, or the lower surface of a vault.

Spandrel:	A triangular space enclosed by the curve of an arch with a horizontal line drawn through its apex and a vertical line drawn through its springing.
Splay:	Any surface included to a main surface, e.g. an inclined window reveal.
Springer:	The stone from which an arch spring.
Springing Line:	The level from which an arch begins.
Spur Stone / Powl Stone / Stone Coddling:	A stone suitably shaped and fixed at the corner of a building or opening to prevent damage to the structure from traffic.
Stool:	A sea. ting such as that on both ends of a sill to which a window jamb is fixed.
Stopped End:	The termination of a moulding worked in the solid.
Stretcher:	A stone laid in a way that its greatest dimension is in the length of the wall.
String / Stringer:	A series of inclined slabs at the free end of steps covering the concrete core and following the line of the staircase.
String Course /Belt Course /Band Course:	A narrow moulded or plain projecting course continued horizontally along the face of a building.
Throating / Throat / Drip:	A grove winked in the under surface of projecting stone work to prevent rain-water from flowing back in the wall.
Through Stone:	Stones which extend through the entire thickness of a wall as a tie or bond.
Toothing:	The end of a wall left with courses breaking joint for future extension.
Transom:	A horizontal bar sub-dividing a window or other opening.
Upstart / Start:	A reveal stone long in vertical dimension.
Voussoirs:	A wedge-shaped stone forming a unite of an arch.

8.1.3.6 Cast Stone

Acid Treatment:	The application of an acid solution to the surface of cast stone for the purpose of removing the superficial cement film and producing slight exposure of the aggregate.
Cast Stone / Artificial Stone (Deprecated) / Reconstructed Stone:	A building material manufactured from cement and natural aggregate for use in a manner similar to and for the same purpose as natural building stone.
Crazing:	The cracking of the surface into small irregularly shaped contiguous areas.
Curing:	The process of maturing cast stone under controlled conditions.

Dry Pressing / Dry Tempering:	The process of producing cast stone using a mix with a minimum water cement ratio. The process permits very early de-moulding.
Drying Shrinkage:	Time slight contraction occurring in a unit during the first drying after casting.
Etching:	A term almost synonymous with 'Add treatment', but it is generally assumed to be a rather more severe treatment, producing a greater aggregate exposure.
Exposed Aggregate:	A finish produced by the removal of surface to expose the colour, texture and pattern of the aggregate.
Filling in / Bagging in / Ragging in:	The treatment of the surface of a unit after casting, with a mixture of cement and fine crushed stone rubbed into the pores of the material to produce a closer texture.
Handling reinforcement:	A material, such as mild steel rod, incorporated in cast stone solely for the purpose of permitting the unit to be handled without damage till it is built into its position on the site.
Insitu-Concrete:	Concrete which is cast in the place where it is required to harden as part of the structure.
Laitance:	The thin layer composed of cement and fine particles of aggregate that may form on the surface of concrete.
Masoned Cast Stone:	Cast stone, after reaching a mature state, treated by hand or by machine to produce surfaces commonly used for natural stone, e.g. boasted, bush-hammered, sparrow pecked, tooled and rubbed.
Maturing:	The process of the hardening of cast stone.
Mould:	A container made of metal, timber or other material, shaped to the pattern it is desired to reproduce, into which concrete is placed.
Plain Cast Stone:	Cast stone which is untreated after removal from a mould.
Precast Concrete:	Concrete which is cast in separate units before being placed in position in a structure.
Retarder:	Material added to concrete during mixing, or applied as a coating to the mould which reduces the rate of hardening of the cement.
Rubbed Finish / Fine Ground Finish:	The finish produced by stoning.
Stoning / Rubbed Finish / Fine Ground Finish:	The grinding by hand of the surface of cast stone with an abrasive to produce an even and smooth texture, but only exposing slightly the surface of aggregate.,

Structural Reinforcement: Material, usually mild steel, incorporated in cast stone to make it strong enough to withstand the tensile stresses induced in the permanent structure.

Terrazzo: A finish consisting of marble (or similar) chippings in a cement matrix, ground after casting to produce a polished surface.

Tooled Finish: A finish obtained by removing the original face with a hand or power-operated tool.

Water Repellent: **Integral** - A material incorporated in a cast stone mix for the purpose of improving the resistance of the finished product to the penetration of moisture.

Surface - A material, usually in liquid form, applied to the surface of cast stone after manufacture for the purpose of improving its resistance to the penetration of moisture.

Milling: The process of converting quarried blocks of stone into a finished product is called milling. It includes the sawing of blocks into slabs of the desired thickness with various types of saws; planning them to improve the surface finish or cut Mouldings on their surfaces; turning columns, balusters etc., in lathes; milling recesses, pattern and lettering on the faces of stones by means of a milling machine; and carving and dressing the stones into various shapes and forms with hand tools or with pneumatic tools operated by hand and finishing the surface to the desired degree of evenness.

The cut or the dressed stone is the product of the stone mill. A stone of large size or special shape or any stone, for which all dimensions are specified in advance. other than finished cut stones, is called dimension stone.

Joints: Mortar layers between stones are called joints. Horizontal joints may be called bed joints or simply beds; while vertical joints are known as joints. For the best arrangement of joints in masonry, each of the face atone is set out on the drawing, especially for building with a classic motif. The following general principles are observed:

- a. All bed joints should be arranged at right angle to the pressure coming upon them.
- b. The joints should be arranged to prevent any members, such us sills, from being under a cross-stress.
- c. The joints should be so arranged as to leave no acute angle on either of the pieces joined.

The first condition applies to all kinds or masonry. It is necessary to prevent any sliding tendency between the stones.

The second condition applies chiefly to sills and lintels. Sills, if bedded along their entire length, are liable to fracture because of the tendency to greater settlement under the piers than under the walls below the openings. To prevent cross-stress, only the

extremities or the sills are bedded, the remaining portion is left under the surface having no bedding.

The third condition applies chiefly to the joints in tracery work, and any exposed joints in any other work. Stone being a granular material, anything approaching an acute angle is liable to weather badly; therefore, in any tracery work having several bars intersecting, a stone is arranged to contain the intersections and A short length of each bar in such a fashion that the joints are:

- a. At right angle. to the direction of the abutting bars, if straight, or
- b. Mille direction of normal to any adjacent curved bar.

This not only prevents any acute angle occurring, as would be the case if the joints were made along the line of intersection of the moulding, but also ensures a better finish, because intersection line can be carved more neatly with the chisel. It is also more lasting than a mortar joint occurring along the above line.

Joggle Joints: This includes tabling joints, cement joggle, dowels and pebble joints which are described briefly below: -

Joggle: It is form of joint in which a portion of the side joint of one stone is cut to form a projection, and corresponding sinking is made in the side of the adjacent stones for the reception of the projection, it is chiefly used in landings to prevent any movement between the stones and to retain a level surface. It also assists in distributing weight liver every stone in the landings.

Tabling Joint: It consists of a joggle formed in the bed joints to prevent lateral displacement in the stones of a wall subjected to lateral pressure, such as in sea-wall. The projection in this case is about 1½ inches in depth and 1/3rd of the stone in width. Slate joggles having a dimension of 12"x4"x2" are often substituted for tabling joints to reduce expenses.

Cement Joggles: It consists of a V-shaped sinking in the side joint of each adjacent stone in a course. These are generally employed in the side joints of the top courses of masonry to prevent lateral movement.

Dowel: It consists usually of pieces of hardstone, slate or copper about 1-inch square in section and varying form about 2 inches to 5 inches in length, being sunk and set in cement in corresponding mortices in the adjacent stones. They are used both in the side and bed joints. They are generally used in top courses of masonry where the weight on or of the individual stone is not great, and also in dressings, about openings and in the bed joints of the drums of columns, balusters, and in any position

where lateral movement is likely of occur. The united mass thus formed from the connected stones renders any movement impossible under normal conditions.

- Pebbles:** Small pebble bedded in cement in the joints of stone are used to prevent lateral motion; they are very economical and effective.
- Cramps:** They are of different types like metal cramps, lead plugs, slate cramps, anchor bolts and rag bolts.
- Metal Cramps:** They are used like dowels to bind work together, but are more particularly useful for positions where stones tend to come apart e.g. in copings, covering a gable, or in face stones of no great depth, or cornices and projecting string courses to tie the stone to the body of the wall or to the steel skeleton supports. Cramps are made of thin pieces of metal of varying length and sectional area according to the work bent at right angle about 1½ inches at each end. A chase with a dove-tailed mortice at each end is made in the stones to receive the cramp, the ends of which are made rough. Metals, of which cramps are usually prepared, are wrought iron, copper and bronze. If wrought iron is used it is usually subjected to some preservative process, such as galvanising, tarring and sanding or coating with a wash of neat cement, to prevent oxidation. Care is taken to cover the cramp completely with the bedding material. The best bedding materials are cement, lead and asphalt. Lead is at times objected to for external work because it tends to form a galvanic couple with the cramp in the presence of moisture, in addition to oxidation.
- Lead Plugs:** Stones may be connected together by means of lead in the following manner. Dove-tail shaped mortices are made to correspond the side joints of two adjacent stones into which, when placed in position, molten lead is poured. When it becomes cool it is chaulked, thus completely filling the mortices and connecting the pieces.
- Slate Cramp:** Consisting of pieces of slate about 7"x2"x1" cut to a double dove-tail form they are bedded in cement in sinkings, formed to receive them, and are generally used in flat coping stones.
- Anchor Bolts:** Long iron bolts are frequently employed at the back of cornices that have great projection. In such cases the centre of gravity of the mass is dangerously near the edge of the wall. The bolts are passed through a hole drilled through the back of the cornice, or are inserted into a chase worked along the back face of the stone, and extended a sufficient distance down the back of the wall, being provided at their lower ends with large iron plates or washers. The effect gives homogeneity to the whole mass, thus bringing the centre of gravity of the combined mass back a sufficient distance from the front of the wall to ensure safety. In

steel framed buildings, steel members of the roof, secured to the building, are designed to tail down must effectively the projecting stone cornices. In pinnacles at the top of spires and buttresses, formed of small stones, it is usual to connects a sufficient number of them together with an iron bolt, which later usually contain their common axis and thus increase stability by rendering the mass homogeneous.

Rag Dolts:

The ends of the bolts are often fixed by having the end that is let into the stone jagged, and run with lead, or cement. The mortices have dove-tail shape to secure it from any upward pressure. It is replaced by an anchor bolt and plate, where there is any probability of a great upward stress. The bolt is passed

Weather Joints:

The term includes all joints or precautions taken to prevent the deterioration of the joints of cornices or other exposed parts of masonry owing to the percolation of water into the joints.

**Saddled Or
Water Joints:**

To protect the joints of cornices and other exposed horizontal surface of masonry, the-sinking is sometimes topped before the joints and weather off. Any water passing down the weathered surface is diverted from the joint.

Rebated Joints:

These joints are used for stone roofs and copings to obtain weather-tight joints. They are of two kinds: (1) When both stones are rebated, (2) When the upper stone only is rebated. In the first case the stones are of the same thickness throughout, their upper surface being level when the joint is made. In the second case the stones are thicker at the bottom edges than at the top, the bottom edges having a rebate taken out equal to the thickness of the upper edge of the stone below it, over which it fits. The part that overlaps should not be less than $\frac{3}{4}$ inch thick. The under surfaces or beds of the stones are made level. The upper exposed surface of all masonry built of soft or porous stones it protected by a lead covering through a hole drilled through the stone.

Stone lintels:

Square openings in buildings are frequently bridged with stone lintels. Stone, owing to its low tensile resistance, is not well suited to act as a beam and its wide openings every care must be taken to relieve these members as far as possible of the weight above. There are two kinds of lintels:

- a. Lintel made of one piece of stone where the opening is small.
- b. Lintel built with several stones where the opening is large.

Where it is inconvenient to use a relieving arch, a flat arch of three stones is constructed above the lintel. The centre stone or key in this type is termed as "The Save". In bedding the save stones. no mortar is placed on the lintel, but the stones are supported in their position by means of small wood wedges. After a sufficient mass of the wall has been built to tail down the side saves, the wedges are removed. In finishing the wall, the

joint between the saves and the lintel is pointed only, thus no weight from the wall above is brought to bear on the lintel.

Where it is inexpedient to employ a relieving arch or a save stone, and where the opening is too great for a single stone to form a lintel, it is often formed by a number of blocks either joggled together or with an iron core. The method now frequently adopted is to build the lintel with a number of pieces; with vertical joints and in two thicknesses; and the front and back portions are made to envelop the flange of a steel girder which bridges the whole span and takes its bearing on the columns. The back-front pieces are connected on the soffit by small copper cramps. The latter are bedded in cement mixed with dust from the stones to be united. The upper surface is connected by cramps of iron or copper, extending from front to back either over the top of the steel girder or through its web. The whole soffit is finally rubbed over with a piece of stone, similar to the lintels, to render the joint as invisible as possible. Care is taken to protect the steel girder from the danger of oxidation by applying one of the preservative processes described for iron and steel.

Where stone lintels are employed over shop fronts, and the span is too great for one stone, steel girders are used to take the weight of the superstructure. Stone fascia is built of a number of stones arranged either as voussoirs with radiating joints or longer stones with vertical joints. In both the cases, the stones are cut at the back to fit in the flanges of the girder and at each joint a bronze dowel is mortised into the adjacent stones securing them together. A bolt is passed through the web of the girder, being sunk half root each stone and hooked at the end over the dowel.

Arched Lintels:

Lintels are often constructed as flat arches, and may be divided into the following kinds:

- a. Lintels having radiating joint and joggle.
- b. Lintels having radiating joint stepped and
- c. Lintels having vertical joint, the stones bolted to sleet girder.
 - (a) The joints are radiated to a common centre and are joggled to prevent lateral movement. Portland cement joggle is used at each radiating joint.
 - (b) The joints radiate to a common centre and are stepped - a method usually considered necessary where a moulded band traverses the lintel. The step renders any dropping of the central voussoirs impossible.
 - (c) This method is usually employed in the formation of large classic entablatures. The lintel has vertical face joints, a secret arch being sometimes formed in the central portion of the joint. However, this being a weak form of arch, the bulk of the weight is relieved by bolting or cramping the stones back to a reinforced concrete or steel beam.

Stone Arches:

Stone arches are extensively used in building construction to span openings in walls and arcades. The stones forming the arch ring are accurately cut to shape, preferably with their bedding planes perpendicular to the arch axis. They are set in cement mortar. The backs of stone arches are commonly stepped to facilitate the joining of arch stones and stone courses of the wall. In arches up to 15 inches thick, through stones are used extending from the intrados to the extrados. In arches over 15 inches thick, it is, at times, convenient to build two rings, in which case the header and stretcher stones are laid alternately. The headers are through stones from intrados to extrados and the stretchers through stones for one ring. In the case of three rings the alternate headers break joint to the amount of the full depth of one ring. In the case of rubble arching, stones are not less than 3 inches thick on their least dimension and break joint for not less than 6 inches. All stones in one course are approximately of the same thickness. The thickness or the joint at the intrados does not exceed half an inch and the open extrados joints are solidly wedged with chips and spawls set in mortar.

For ashlar fine tooled work, no stone has a length of less than 12 inches while 50% of them have a length of 18 inches or more. The thickness of the joints does not exceed 3/16 inch and all joints radiate properly from the centre of the curve. In the case of block-in-course, the thickness of stones is not less than 6 inches on their least dimensions, but the thickness of joints does not exceed 1/4 inches.

Stone Pitching on Slopes:

The slopes of rail or road embankments, spurs, excavations, canals, river banks, etc., are stone pitched to preserve and protect them from rain, wave-washed weather, etc., This pitching is properly tooled down by having a proper foundation, and it is usual to put an adequate length of horizontal bed pitching called the apron where deep scours are anticipated. The pitching is graded by having a layer of spawls or finer material under the stone which is known as backing or sub-grade and is compacted well. Backing as well as pitching are done simultaneously. The thickness of pitching depends upon the force of water current to which it is to be subjected. Groynes and flood embankments have usually 2 feet thick pitching made up of 0.7-foot spawls or subgrade and 1.3 free stone. Stones are as big as possible up to the size of the pitching and laid closely and firmly bedded with their length perpendicular to the face of pitching. They must be durable and tough stone. Surface of pitching must be left rough and not dressed to smoothness, because rough surface is more effective for guarding against wave-wash. Normally pitching should be done by quarried stone. Boulders are only used where they are available locally or where it cannot be helped.

Pitching in Bed or Apron: As mentioned above it is necessary to provide a wide stone apron of suitable thickness at the toe the pitched slope for protection against scour. Without an apron, the stone-pitched slope would obviously slip into any scour hole that is formed at the toe of the pitching. The stone apron would take up all the slipping into the scour hole that is necessary and thus keep the pitched face intact. The design of a stone apron would depend upon the following factors:

- a. The depth of the maximum scour that is likely to occur.
- b. The sub-surface slope which is likely to be taken up by the side of the scour hole. This is usually taken as 2:1 minimum.
- c. Thickness of the uncrodible coating required on the slope of the scour hole. It is usual to take this thickness as 2 feet for the purpose of design. The volume of the stone per foot run of an apron would thus be:

$$5 \times D \times 2 = 4.5 D \text{ cft. (Approximate)}$$

D is the difference between the low water level un which the apron is laid and the anticipated scoured bed measured in feet. The width of the apron is usually kept as 1½ time the depth of the maximum scour, since it is desirable to keep-the scour hole at a distance from the slope so us to ensure a minimum sub-surface slope of 2:1.

8.1.2 Stone

Stone shall be produced from an approved source and shall conform to Section 11-1 for stone. Approved sample of the stone shall be retained as a standard of martial to be furnished at the site of work. All stone used in the work shall be equal in all respects to the approved samples.

8.1.3 Mortar

8.1.3.1 Composition

Mortar shall be used as specified in bill of quantities.

8.1.3.2 Preparation

It shall be prepared in accordance with the relevant provisions set forth in Chapter-5 of Book-2 of these specifications for the specified mortar.

8.1.3.3 Water

Water shall conform to Book-1 (Specification for Engineering Material).

8.1.4 Stacking of Stone

Through bond stone shall be staked separately and shall be marked on the face with tar or paint. Marks shall be made on the inner face or face to be plastered.

8.1.5 Tools and Equipment

All equipment used for mixing and transporting mortar for laying stone shall be clean and free from set mortar dirt or other injurious foreign substances. The equipment shall be thoroughly cleaned at the end of each day's work.

8.1.6 Wetting of Stone

Before use, all stone shall be soaked in clean water in a tank or a pit for at least 2 hours, except in case of masonry in mud mortar where dry stone shall be used.

8.1.7 Laying Stone Masonry

(a) Every stone shall be laid in the work on its natural quarry bed or in such a manner that the stresses borne by it come normal to such bed.

(b) Whenever breaks are unavoidable, joints shall be made in gradual steps. Cross walls shall be carefully bonded into the main wall and junctions of wall shall be formed at the time the walls are being built.

(c) Each stone shall be set with both bed and vertical joints filled with mortar, except in case of dry-stone pitching or masonry and thoroughly bedded in.

(d) All masonry shall be taken up in truly plumb or at Specified slope in the case of batter.

(e) Quoins and jambs shall be laid at a true right angle to the bed corners being straight and vertical. In the case of masonry with hammer dressed stone a chisel draft one-inch wide shall be given in each external face to allow accurate plumbing. Quoins shall be laid using headers and stretchers alternately.

(f) Jambs for door and window opening shall be formed with quoins of the full height of the course. The length and breadth of the quoins shall be at least $2\frac{1}{2}$ times X $1\frac{1}{4}$ times the depth of the course respectively. For door openings three and for window openings two of these quoins shall be stone of full thickness of wall. Door and window frames shall be let into $\frac{1}{2}$ inch in the quoins.

8.1.8 Fixture

Holdfasts and similar fixtures shall be built in with the surrounding stone masonry in their correct position in specified mortar. These shall be built in as the work progresses and not inserted later on onto space left for them.

8.1.9 Lintels and Inside stone

All lintels and inside stones, not to be plastered over, shall be of the full width of the wall in which they are laid, including the thickness of the plastered face or faces.

8.1.10 Openings

Door and window openings shall have flat or relieved arches or lintels spanning across them as shown on the drawing or as specified.

8.1.11 Scaffoldings

The contractor shall provide all scaffolding, staging, ladders etc., necessary for the work. All walls or other stone masonry of the building shall be securely braced and protected against damages by wind and storms during construction. No extra rate will be paid for this item of work.

8.1.12 Centering

The centering for all openings shall be strong enough to support lintels or arches spanning the openings. They shall be subjected to the approval of the Engineer-in-charge and shall remain in position till stone masonry has set. No additional payment will be made to the contractor for this item of work.

8.1.13 Putlogs

Only headers shall be left out to allow a putlog to be inserted and not more than one Stone shall be left out for each putlog. Under no circumstances shall putlogs be made immediately under or next to the impost skew back of arches.

8.1.14 Rounded Corner

Corners shall be rounded where specified (Such work shall be payable separately in the case of exposed masonry but not in the case of masonry to be plastered).

8.1.15 Striking of joints

The exposed surface shall be finished as specified. Joints shall be struck simultaneously with masonry work keeping the face of the work clean. (Payment for striking the joints shall be made separately on superficial area of the masonry.)

8.1.16 Bed Plates

Bedplates shall be provided under all beams and joists. They shall be chisel dressed on all faces and conform to the dimensions given in the drawing and shall be carefully laid having fine joints with the specified packing to give the correct level.

8.1.17 Cramps

Cramps, joggles and dowels shall be used whenever specified or directed by the Engineer-in-charge. Cramps shall be from 6 inches to 12 inches in length, 3/8 inch in thickness and 1 inch to 2 inches in width, as specified. They have each end turned at right angle. Copper cramps shall be forged, and set with neat cement. Lead cramps shall be formed by running molten lead into the dove-tail channels. Joggles and dowels shall be of double wedge form and made of copper, slate or similar material and set in neat cement. On no account iron cramps, joggles or dowels, whether galvanized or otherwise, shall be used.

8.1.18 Protection and Watering

All stone masonry shall be protected during construction from the effects of rain and frost by suitable covering. The masonry laid in cement and lime shall be kept moist for a period of 10 days.

8.1.19 Coping and Corners

Coping stone shall be of full size throughout, of dimensions indicated on the drawing or as specified, if not shown on the drawing. Beds, joints and top shall be fine pointed. All coping shall be dowelled or cramped as specified, and the corners of pillars skew back and similar work shall be joggled to the stone below, if so specified.

8.1.20 String Courses

The string courses shall tail at least 9 inches into the work, a full bearing for at least 4 inches and shall be paid for at rate per running foot along the course. They shall also be throated on the underside, if so, directed by the Engineer-in-charge.

8.1.21 Measurements

Stone masonry shall be measured by volume. The unit of payment shall be 100 cubic feet or cubic meter. No deduction shall be made for opening having a superficial area of 1 Sft or less.

8.1.22 Rates

8.1.22.1 Labor Rates

The unit rate (on labor basis) shall include the cost of the building stone masonry, cutting and dressing stone to the specified degree of refinement, curing and protecting as per above specifications and any other specifications specially included in the contract. It shall further include the cost of providing, using and required for building stone masonry as per above specifications.

8.1.22.2 Composite Rates

The unit rate shall include the cost of stone, mortar and any other material required, in addition to the rate detailed above.

8.2 Dressing and Cutting of Stones

8.2.1 Description

This work shall consist of dressing & cutting stones. All visible edges shall be free from chipping.

8.2.2 Cut Stone Work

It shall be executed accurately in accordance with the design and worked to approve templates. The exposed face shall be finished as specified or as directed by the Engineer-in-charge.

8.2.3 Fine Dressed Stone

Also called three-line dressed stone, it shall be fine chisel dressed having the best surface, which can be given to a stone with chisel and without rubbing. A straight edge laid along the face of the stone so dressed shall be in contact with the surface at every point.

8.2.4 Chisel Dressed Stone

Also called two-line dressed, it shall be sparrow picked or chisel dressed so that no portion of the dressed face is more than 1/8 inch from a straight edge placed on it.

8.2.5 Rough Tooled Stone

Also called one-line dressed, it shall be sparrow picked or chisel dressed so that no portion of the dressed face is more than ¼ inch from a straight edge placed on it.

8.2.6 Hammer Dressed Stone

Scrabbled or hammer dressed stone shall be dressed with a scabbling hammer without any picking chiseling or rubbing.

8.2.7 Measurements

All cut stone, moulded or ornamental stone shall be measured by superficial area of each stone unless otherwise specified in BOQ.

8.2.8 Rates

The unit rate for dressing /cutting or molding shall include dressing / cutting or molding the stone as per above specifications and stacking at the site of dressing.

8.3 Ashlar Masonry

It consists of sawed, dressed, tooled rubbed, or moulded stone with extremely fine bed and end joints. The thickness of these joints never exceeds 1/8 inch. Such accurate work is only possible when the stone blocks are cut perfectly true to the required shape, and therefore the beds, and joints at least are sawn. Great care is exercised in determining the sizes and proportions of the blocks of stones to ensure that they conform the general scale of the building. Badly proportioned stones, which are either too small or log large for the purpose, completely mark the appearance of the work. The minimum thickness of the stones or the course recommended for thig sort of masonry is 12 inches: An adequate bond of blocks of uniform size is obtained if the length of each stone ranges from two to three times the height and if the courses break joints on the face by at-least half the height of the course.

8.3.1 Scope

Ashlar masonry shall be finished in line with the specified architectural details, dimensions and grades in a workman like manner according to following specifications.

8.3.2 Stone Dressing

Every stone in fine ashlar shall be dressed on all beds, joints and faces, full true and out of winding if the surface is plain or to uniform curve and twists if so specified.

8.3.3 Thickness of Joints

Stone shall be set in specified mortar, the beds or joints being in no case more than 1/8 inch in thickness. Each stone shall be struck with a maul, when laid, to bring it to a solid bearing, both to the bed and the joints.

8.3.4 Size of Stone

Stone shall be laid in regular course not less than 9 inch in height. All courses shall be of the same height unless otherwise specified. No stone shall be less in breadth than 1¼ times its length or less in length than 2½ times its height.

8.3.5 Bond

The face stone shall be laid header and stretcher alternately unless otherwise specified. The headers are arranged to come as nearly as possible in the middle of the stretchers below and the stone in adjacent layers shall break joints on the face for at least half the height of the course, and the bond shall be carefully maintained throughout.

8.3.6 Through Stone

In walls 2½ feet thick and less the header shall run right through the wall.

8.3.7 Courses

The courses line shall be horizontal and side joint vertical throughout.

8.3.8 Jambs

Jambs in door and window openings shall be formed with quoins of the full height of the course. Unless otherwise specified, the quoins shall not be less in breadth than 1½ times or in length less than twice the depth. At least three quoins in case of doors, and two quoins in case of window, shall be stones of the full thickness of the wall.

8.3.9 Other Respects

In all other respects the work shall comply with 8.1 Stone Masonry (General).

8.3.10 Measurements

Stone masonry shall be measured by volume. The unit of payment shall be 100 cubic feet or cubic meter. No deduction shall be made for opening having a superficial area of 1 sft or less.

8.3.11 Rates

8.3.11.1 Labor Rates

The unit rate (on labour basis) shall include the cost of the building stone masonry, cutting and dressing stone to the specified degree of refinement, curing and protecting as per above specifications and any other specifications specially included in the contract. It shall further include the cost of providing, using and required for building stone masonry as per above specifications.

8.3.11.2 Composite Rates

The unit rate shall include the cost of stone, mortar and any other material required, in addition to the rate detailed above.

8.4 Rough Tooled or Bastard Ashlar

8.4.1 Description

The faces exposed to view shall have a fine dressed chisel draft, one inch wide, all round the edges and be rough tooled between the drafts, and on all beds and joints, which shall not exceed 3/8 inch in thickness.

8.4.2 Mortar

The stone shall be set in specified mortar. Mortar shall conform to Chapter-5 of Book-2 of these specifications.

8.4.3 All other Respect

The stone shall be set in specified mortar. In other respects, such as size of stones, bond, jambs, courses etc., specification shall be the same as laid down as specified in 8.3 "Ashlar Masonry".

8.4.4 Measurements

Stone masonry shall be measured by volume. The unit of payment shall be 100 cubic feet or cubic meter. No deduction shall be made for opening having a superficial area of 1 sft or less.

8.4.5 Rates

8.4.5.1 Labor Rates

The unit rate (on labour basis) shall include the cost of the building stone masonry, cutting and dressing stone to the specified degree of refinement, curing and protecting as per above specifications and any other specifications specially included in the contract. It shall further include the cost of providing, using and required for building stone masonry as per above specifications.

8.4.5.2 Composite Rates

The unit rate shall include the cost of stone, mortar and any other material required, in addition to the rate detailed above.

8.5 Rock Rustic or Quarry Faced Ashlar Masonry

It shall be similar to 8.4 "Rough Tooled or Bastard Ashlar" of these specifications, except that the exposed faces of the stone between the drafts shall be left rough as the stone comes from the quarry. But no rock face or "bushing" shall project more than 3 inches from plane of drafts. The drafts may be omitted altogether, except at quoins if required for architectural purposes or as specified.

8.6 Ashlar Facing

8.6.1 General

The faces of stone shall be, as specified, rough-tooled, rustic (with or without chisel draft, except at quoins) or chamfered. For a particular work, facing shall have, as specified, a backing of brickwork, concrete or bubble masonry.

8.6.2 Dressing of Stone

In walls of rubbles or concrete faced ashlar, the dressing shall be as specified, except for the dressing of the backs of stone, which may be left rough in the state they are received from the quarry.

8.6.3 Size of Stone

No course shall be less than 8 inches in height. One-third of the entire length of each course shall be headers, used at regular intervals. Headers shall not be less than the breadth of the ashlar stone plus 18 inches. Unless otherwise specified, no stone shall be less than 1½ feet long.

8.6.4 Depth of Facing

Unless otherwise specified, the depth of the facing shall not be less than 4½ inch and 9 inch in alternate courses.

8.6.5 Height of Courses

The height of the courses shall be equal to the exact number of courses of brick or rubble with intermediate mortar joints. The backing shall be carried up simultaneously with the face work.

8.6.6 Beds and Joints

Beds and joints shall be true and square for at least 4½ inches and 1½ inch respectively from the face. Beds and joints shall not be more than 1/8-inch-thick and ¼ inch thick respectively.

8.6.7 Bond Stone

Bond stones shall run right through backing when wall is not more than 2½ feet thick. In case it is thicker, stones shall overlap at least 6 inches and shall be inserted between 5 feet and 6 feet apart, clear in every course.

8.6.8 Measurements

In work of this sort, the face work alone shall be measured and paid for as ashlar, as is dressed back, according to the type of ashlar; masonry true and square on the beds and joints, 1/3rd more is allowed for headers (e.g. in 12 inches courses a thickness or 16 inches from the face would be paid for as ashlar), and the remainder is paid for according to the character of the backing.

8.6.9 Rates

8.6.9.1 Labor Rates

The unit rate (on labour basis) shall include the cost of the building stone masonry, cutting and dressing stone to the specified degree of refinement, curing and protecting as per above specifications and any other specifications specially included in the contract. It shall further include the cost of providing, using and required for building stone masonry as per above specifications.

8.6.9.2 Composite Rates

The unit rate shall include the cost of stone, mortar and any other material required, in addition to the rate detailed above.

8.7 Ashlar Block in Course Masonry

8.7.1 Dressing

Stone shall be rough tooled on all beds and joints as so to give rectangular shape. Faces shall be accurately square and all face joints dressed at right angle to the face for a distance of 4 inches.

8.7.2 Size of Stone

Each course shall consist of stones of even thicknesses and no course shall be less than 6 inches in height. Stones shall break joints on the face by at least half the height of the course. No course shall be greater in height than the one below it. No stones in face, except closer, shall have less breadth than height. No stone shall tail into the wall less than its height and at least 1/3rd of the face stones shall tail into the wall twice their height.

8.7.3 Laying

All courses shall be laid with beds truly horizontal and joints truly vertical. Each bed and joint shall be full of the mortar specified and each stone shall be struck with a wooden maul to bring it to a solid bearing. No face joint shall be thicker than ¼ inch.

8.7.4 Bond Stone

In walls less than 2 feet thick, through stone shall be inserted at every course at 5 feet internals breaking joints with similar stone in courses above and below. In walls more than 2 feet thick through stone shall overlap each other by at least 6 inches.

8.7.5 Other Respects

In other respects, the work shall comply with the specifications for Stone Masonry (General).

8.7.6 Measurements

It shall be measured by volume. The unit of payment shall be 100 cubic feet or cubic meter. No deduction shall be made for opening having a superficial area of 1 sft or less.

8.7.7 Rates

8.7.7.1 Labor Rates

The unit rate (on labour basis) shall include the cost of the building stone masonry, cutting and dressing stone to the specified degree of refinement, curing and protecting as per above specifications and any other specifications specially included in the contract. It shall further include the cost of providing, using and required for building stone masonry as per above specifications.

8.7.7.2 Composite Rates

The unit rate shall include the cost of stone, mortar and any other material required, in addition to the rate detailed above.

8.8 Ashlar Block in Course Facing

8.8.1 General

Walls built in brickwork, concrete or rubble masonry shall be faced with ashlar block in course masonry. The work shall comply with specification for Ashlar Block in Course Masonry with the following exceptions.

8.8.2 Sizes of Stones

No stone shall be less than 6 inches, and 1/3rd of the entire length of the stone shall be header. No stone shall be less than 15 inches long. The depth of the facing shall not be less than 10½ inches. No header shall project less than 10½ inches into the backing.

8.8.3 Height of Course

The height of the course shall equal an exact number of courses of brick or rubble with intermediate mortar joints. The backing shall be carried up simultaneously with the face work.

8.8.4 Beds and Joints

Beds and joints shall be rough-tooled, true and square for at least 3 inches and 1½ inches thick.

8.8.5 Bond Stone

Bond stone shall run right through the backing when the wall is less than 2 feet thick. In thicker walls they shall overlap at least 6 inches. Bond stone shall be inserted 5 feet apart in every course.

8.8.6 Face

The face of the stone shall be left rough (but no projection shall exceed 2 inches) without chisel draft, except at quoins, where ½ inch draft shall be given.

8.8.7 Mode of Measurements

Only so much of the face stone as is dressed back full, true and square from face shall be measured and paid for as block in course. One third shall be added for headers. The remainder work shall be measured and paid for according to the character of the backing.

8.8.8 Rates

8.8.8.1 Labor Rates

The unit rate (on labour basis) shall include the cost of the building stone masonry, cutting and dressing stone to the specified degree of refinement, curing and protecting as per above specifications and any other specifications specially included in the contract. It shall further include the cost of providing, using and required for building stone masonry as per above specifications.

8.8.8.2 Composite Rates

The unit rate shall include the cost of stone, mortar and any other material required, in addition to the rate detailed above.

8.9 Copings, Cornices and Columns

8.9.1 Stone

Stone cornices, copings, pillars, string courses, corbels, brackets, chajjas and similar works shall be made from stone of uniform color and texture and of the kind specified for each.

8.9.2 Dressing

The stone shall be dressed full or to the approved templates. Unless otherwise specified, the exposed faces shall be fine chisel dressed (three line). All visible angles and edges shall be free from chipping.

8.9.3 Size of Stone

No stone shall be less than 18 inches in length nor less in height than the height of the copings. In cornices and string courses which do not extend right through wall, every stone shall tail into the wall by at least as much as the projection behind the face of the wall and in no case less than 6 inches. Coping stone shall extend the entire depth of the coping, unless otherwise specified or directed by the Engineer-in charge in writing.

8.9.4 Mortar

Cornices, string courses, corbels and pillars shall be set in lime mortar or cement mortar of specified mix depending upon the rest of the masonry.

8.9.5 Chajjas

Chajjas in the case of isolated windows, shall consist of a single stone; in continuous chajjas all joints shall come over the brackets.

8.9.6 Joints

No joint shall be more than 1/8 inch in thickness.

8.9.7 Weathering and Throating

All outside cornices, copings, corbels and similar projecting courses shall be weathered on the top and throated underneath.

8.9.8 Dowels

Coping stones and other similar works are to be cramped or dowelled and courses of pillars, skew backs and similar works shall be joggled, wherever specified.

8.9.9 Measurements

Cornices, string courses and chajjas shall be measured by length. The unit of measurement shall be one foot. Copings shall be measured by volume. The unit of measurement shall be 100 cubic feet or cubic meter.

8.9.10 Rates

8.9.10.1 Labor Rates

The unit rate (on labour rate basis) for cornices/string courses/copings/chajjas shall include the cost of carrying out cornices/string courses/copings/chajjas, cutting and dressings stone. Whenever required, curing and protecting it as per above specifications and/or any other specifications specially included in the contract. It shall further include the cost of providing, using and removing scaffolding, shuttering, centring, staging, ladders, supports and other tools and plants required for carrying out cornices/string courses/copings/chajjas as per above specifications.

8.9.10.2 Composite Rates

The unit rate shall include the cost of stone, mortar and any other material required in addition to the labour rate detailed above.

8.10 Course Rubble Masonry (1st Class)

8.10.1 Height of Course

Stone shall be laid in horizontal courses not less than 6 inches in height. All stones in a course shall be of equal height and all courses of the same height, unless otherwise specified. But no course shall be thicker than the course below it. All stones shall be set full in specified mortar in beds and joints.

8.10.2 Dressing

The face stone shall be square on all joints in masonry. The beds shall be hammer or chisel-dressed, true and square, for at least 3 inches back from the face, and the joints for at least 1½ inches. The face of the stone shall be hammer dressed and “bushing” not to project more than 1 ½ inches.

8.10.3 Thickness of Joints

All side joints shall be vertical and beds horizontal, and no joint shall be more than 3/8 inch in thickness. No pinning shall be allowed on face.

8.10.4 Size of Stone

No face stone shall be less in breadth than its height, nor shall it tail into the work to a length less than its height; at least 1/3rd of the stone shall tail into the work at least twice its height or in walls thicker than 2 feet, three times its height.

8.10.5 Through stones and Headers

Through stones shall be inserted 5 to 6 feet apart in every course, and shall run right through the wall, not more than 2 feet thick. When the wall is more than 2 feet thick, a line of two or more headers shall be laid from face to back, which shall overlap each other at least 6 inches. The headers shall have a length of at three times the height.

8.10.6 Breaking of Joints

Stone shall break joint by at least half the height of the course.

8.10.7 Quoins

Quoins shall be of the same height as the course in which they occur, shall be formed of stone at least 1½ feet long and shall be laid stretcher and header alternately. They shall be laid square on their beds which shall be fairly dressed to a depth of at least 4 inches.

8.10.8 Inferior Face

The work on the interior face shall be precisely the same as on the exterior face, except that side joints need not be vertical.

8.10.9 Hearting

The interior of the wall, called hearting, shall consist of flat-bedded stones carefully laid on their proper beds and solidly bedded in mortar. Chips and spawls of stone are wedged in, wherever necessary, so as to avoid thick beds or joints of mortar. No dry work or hollow spaces shall be left anywhere in the masonry. The face work and hearting shall be brought up evenly, but the hearting shall not be levelled up at each course by the use of chips.

8.10.10 Other Respects

In all other respects it shall conform to the specification for Stone Masonry (General).

8.10.11 Measurements

It shall be measured by volume. The unit of payment shall be 100 cubic feet or cubic meter. No deduction shall be made for opening having a superficial area of 1 sft or less.

8.10.12 Rates

8.10.12.1 Labor Rates

The unit rate (on labour basis) shall include the cost of the building course rubble masonry, cutting and dressing stone to the specified degree of refinement, curing and protecting as per above specifications and any other specifications specially included in the contract. It shall further include the cost of providing, using and required for building stone masonry as per above specifications.

8.10.12.2 Composite Rates

The unit rate shall include the cost of course rubble masonry, mortar and any other material required, in addition to the rate detailed above.

8.11 Course Rubble Masonry (2nd Class)

8.11.1 Scope

Course rubble masonry (2nd class) shall conform to the specification for Course Rubble Masonry (1st class) with the following exception.

- All stones in a course need not be of the same height, but short lengths of course shall be made up by two courses, equal in height to the through course. No course shall be of a height greater than the course below it. The thickness of the joint shall not exceed half an inch.
- In each course, headers, hammer dressed and of the full height of the course, shall be placed 5 feet apart. Each header shall have a breadth not less than the height and shall tail into the work at least three times its height. Between the headers each course shall be built of smaller stones not less than 2 inches thick of which there may be two or three in the height of the course. These stones need not be dressed but shall be as flat bedded as possible. Side joints need not be vertical, but no side joint shall form an angle with a bed joint sharper than 60°. No stone shall be less in breadth or length than its height, and care shall be taken to make the stone in different courses break joint. All stones shall be set full in mortar. The thickness of joint shall not exceed 5/8 inch.

8.11.2 Other Respects

In all other respects the work shall comply with the specifications for Stone Masonry (General).

8.11.3 Measurements

It shall be measured by volume. The unit of payment shall be 100 cubic feet or cubic meter. No deduction shall be made for opening having a superficial area of 1 sft or less.

8.11.4 Rates

8.11.4.1 Labor Rates

The unit rate (on labour basis) shall include the cost of the building course rubble masonry, cutting and dressing stone to the specified degree of refinement, curing and protecting as per above specifications and any other specifications specially included in the contract. It shall further include the cost of providing, using and required for building stone masonry as per above specifications.

8.11.4.2 Composite Rates

The unit rate shall include the cost of course rubble masonry, mortar and any other material required, in addition to the rate detailed above.

8.12 Random Rubble Masonry

8.12.1 General

Stone shall be hammer dressed on the face and on the sides and beds to such an extent that weak corners are chipped off and the stones come into close proximity, when laid. Each stone shall be laid on its quarry bed and shall be wedged or pinned strongly into position in the wall by spawls or chips which may show on the face.

8.12.2 Joints

No stone shall tail into the wall less than 1½ times its height. The stone shall be arranged to break joints as much as possible. Care shall be taken to avoid long continuous vertical joints.

8.12.3 Through Stone or Headers

One header stone shall be inserted at least every 5 square feet of the surface and shall run right through the wall if it is not more than 2 feet thick. If the wall is more than 2 feet thick, a line of headers shall be laid from face to back which shall overlap each other at least 6 inches.

8.12.4 Hearting

Hearting or interior filling between the front and back face shall consist of rubble stone, not less than 6 inches in any direction, carefully laid, hammered down with a wooden mallet into place and solidly bedded in mortar. Chips and spawls of stone shall be used, wherever necessary, so as to avoid thick beds or joints of mortar. No dry work or hollow spaces shall be left anywhere in the body of the masonry. Hearting shall be laid nearly level with each course except that at about 3 feet interval vertical "plumbs" projecting 6 to 9 inches shall be firmly embodied to form a bond between successive courses. Hearting shall not be brought to the same level as the front and back stones by the use of chips. The use of chips shall be restricted to only wedges in the hearting.

8.12.5 Other Respects

In all other respects, the work shall comply with the specification No: 22.1 for stone Masonry (General).

8.12.6 Measurements

It shall be measured by volume. The unit of payment shall be 100 cubic feet or cubic meter. No deduction shall be made for opening having a superficial area of 1 sft or less.

8.12.7 Rates

8.12.7.1 Labor Rates

The unit rate (on labour basis) shall include the cost of the building random rubble masonry, cutting and dressing stone to the specified degree of refinement, curing and protecting as per above specifications and any other specifications specially included in the contract. It shall further include the cost of providing, using and required for building stone masonry as per above specifications.

8.12.7.2 Composite Rates

The unit rate shall include the cost of course rubble masonry, mortar and any other material required, in addition to the rate detailed above.

8.13 Dry Rubble Masonry

8.13.1 Size of Stone

Dry rubble masonry shall be laid with the largest practicable size of the stone available-the larger stone being used in the lower courses.

8.13.2 Beds

Stone shall be roughly dressed to secure the maximum bedding surfaces without unduly reducing the size of the stone. Each course shall be built through the entire thickness of the wall.

8.13.3 Bond Stone

Bond stone shall be provided in each course at an interval of 5 feet. It shall be of the height of the course in which it is to be used, at least as broad and of the greatest length procurable. No bond stone shall be less than 2 feet long. When the length is less than the thickness of the wall 2 or more stones shall be used overlapping each other by at least 6 inches to provide through bond from front to back. All bond stones shall be separately stacked before use and marked so that they can be identified after having been built in the wall.

8.13.4 Filling

Wherever required, filling behind dry stone walls shall be done immediately with stone refuse or chips. Earth shall not be used where stone refuse is available.

8.13.5 Measurements and Rates

In respect of the measurements and rates it shall conform to the specifications for stone masonry (General).

8.14 Stone Masonry in Arches

8.14.1 General

Unless otherwise specified, all stone masonry in arches shall be finished in a workmanlike manner, true to dimensions and grades shown on the drawings or according to the. Following Specifications.

8.14.2 Cutting, Dressing of Stone

Stone to be cut and dressed shall follow the Specifications.

8.14.3 Centring

Centring shall be strong enough to bear the weight of an arch without any deflection. The surface of centring shall be correctly struck to the curvature of the soffit of the arch.

8.14.4 Wedges and Sand Boxes

Centers of arches of over 5 feet span shall be erected on wedges. Centers of over 10 feet span shall be on double wedges and of those over 20 feet span on sand boxes so as to allow the gradual lowering of center. (i.e. striking).

8.14.5 Building of Arches

The building of arches shall not begin until the abutments have been built to their full width and up to the level of skew backs. Arch work shall be done evenly from both abutments, and as soon as the arch is complete, masonry shall be built evenly on both sides to the heights of the crown so as to load the haunches. Stone masonry in arches shall conform to the specifications for Stone Masonry work, except with the following modifications.

- In all arches, the voussoir joints shall be truly radial. Stone shall be laid in full beds of mortar and shall be well rubbed and pressed into their beds so as to squeeze out surplus mortar and leave the joints as thin as possible.
- Joints in arches shall not exceed $\frac{1}{4}$ inch in thickness at any point. Radial joints in gauged arches shall not exceed $\frac{1}{8}$ -inch thickness.
- Skew backs shall be formed of stone correctly shaped to radiate from the center of curvature and shall not be packed with mortar or chips. Before the building of an arch is started abutments shall be exactly at the same level and skew backs in place.
- For gauged arch work, the arch shall be laid out full size on the ground on plaster and all joints carefully marked out. Templates shall then be made as a guide for the special shapes of stones. Stones shall be carefully cut and then rubbed to the required shape. All the stones for any arch shall be prepared in full and set up dry on the ground before commencing work.
- Segmental arches used over rectangular door or window openings shall have a flat rectangular soffit and segmental extrados.
- Flat arches shall be built in the same manner as gauged arches but with all the voussoir joints converging on the apex of an equilateral triangle described on the soffit of the arch. Cross joints and extrados shall be parallel to the soffit. The arch shall be built with a camber of $\frac{1}{8}$ per foot of span.
- Arches shall be built in concentric rings and each ring shall be completed before work on the ring above is started. In all cases, care shall be taken that the center line of the

stone face is radially placed. The arch rings shall, in all cases, be bonded together by special bond stone.

8.14.6 Through Stone

In the case of arches in walls the two springers and the key stone and every third stone in between shall be through stones. Unless otherwise specified, all stones, shall be through stones in the case of ashlar walls having a thickness of 2½ feet or less.

8.14.7 Size of Stone

Unless otherwise specified, the height of each stone shall be equal to the thickness of the arch up to 15 inches. Above this, two stones may be used, but no stone shall be less than 6 inches in height. The intrados of all stones shall be rectangular, no side being less than 4 inches (rhembold in skew arches).

8.14.8 Breaking Joints

All stones in arches shall have their ends inside the wall squarely dressed. All joints shall break with each other and no stone shall lie over a circumferential joint by less than half the width of the extrados.

8.14.9 Measurement and Rate

In respect of measurements and rates it shall conform to the specification for Stone Masonry (General).

8.15 Dhajji Walls

8.15.1 Timber

Timber for the framing shall comply with the general Specifications for timber and wood work. If kail or similar wood are used in the framework, all exposed timbers subject to wear, such as the sills of doors and windows shall be made from deodar or oak, unless specified otherwise.

8.15.2 Framework sills Bresseumers Posts

The frame shall usually consist of a sill at the bottom and a bressumer on top each 5 inches by 5 inches in section, and of the longest lengths procurable. Vertical posts shall be tenoned into these at all comers and junctions of walls, and elsewhere about 4 feet apart, but so spaced as to form the door and window openings all posts shall be single pieces, and 5 inches by 5 inches in section.

8.15.3 Horizontal Pieces

Into these posts shall be notched horizontal pieces. 5 inches by 3 inches in sections. one line being; at the level required to from the lintel of doors and windows, and the rest so spaced along the height of the wall that no panel shall be more than 4.5 feet high.

8.15.4 Diagonal Bracing

The panels shall be strutted diagonally by board of 5 inches by 1.5 inches fitting tightly into the corners halved into one another at the point of intersection. The diagonal bracing shall be omitted if brick naggig is provided in the panels. In that case first class burnt bricks shall be used.

8.15.5 Doors and Windows Separate Chowkats

The framing of door and window openings shall be so built that chowkats can be fixed to the timber forming framework. When doors and windows are hung on chowkats, they shall be measured over the chowkats in the customary manner.

8.15.6 Without Chowkats

Where required, the framing shall be so constructed that no separate chowkats are needed, but the leaves hung on the frame timbers shall be made with necessary rebates to take the leaves. Doors and windows shall be paid in that case on the net area of the opening; the dept of the frame or chowkats shall be excluded from the measurement.

8.15.7 Protection from Damp Ground

The framing of dhajji walls shall be erected on a plinth of bricks or stone not less than 12 inches high from the ground. The sill shall be laid on an adequate damp proof course, and at such a level that its top is not more than two inches above the floor.

8.15.8 Paint with Wood Preservatives

Before finally fitting the framing together all the timbers, including the shaped ends, scarfs and mortices, shall be given two coats of an approved and specified wood preservative like hot solignum, creosote.

8.15.9 Iron Fastenings

Having erected the framing, the vertical and horizontal members shall be firmly fastened together on both side of all junctions with 3/8-inch diameter spikes and the diagonal braces secured with 4 inches wire nails.

8.15.10 Filling

The framework shall then be filled with the specified class of brickwork or shone masonry. Brickwork or masonry shall comply with the relevant Specification for each type of work.

8.15.11 Filling to the Tight

All joints in the filling shall be as line as practicable with the stones or bricks breaking joint in every course and firmly wedged against the framing to hold the panel against any lateral thrust. In the case of stone filling all stones shall be through stones with flat beds, and laid to fit close against the diagonal bracing.

8.15.12 Inner Walls to be Plastered

Inner walls shall be plastered over the filling as well as the framework, which shall be covered with 1/2-inch mesh wire netting kept 1/4 inch away from the wood work or have nails driven into it to form a key for the plaster. The rate for dhajji walling shall include a suitable treating of the framework for plastering.

8.15.13 Finishing of Outer Walls

Outer walls shall be finished with (a) plaster over the entire wall, or (b) plaster over the brick or masonry filling, (only the plaster being stopped against the frame) or (c) pointing. In the case of (a) the instructions in 12 above shall apply. If the filling only is to be plastered or if it is to be pointed the filling shall be so laid in the frame that the framework will project 1/8 inch beyond the finished plastered or pointed surface.

8.15.14 Measurements

Dhajji walling shall be measured by superficial area. The unit of measurement shall be one square foot.

8.15.16 Rates

The unit rate for dhajji walling shall include the provision and erection of the timber framing and filling with brickwork or masonry in accordance with the above specifications, this rate shall not include the plastering and/ or pointing of the face of the wall.

8.16 Stone Revetment of Pitching

8.16.1 Types of Stone

Stone for Pitching shall conform to the specifications for pitching stone.

8.16.2 Profile

The surface to be pitched shall be trimmed to the specified slope and well consolidated before the sub-grade is laid on it.

8.16.3 Sub grading

The hacking or sub-grading shall consist of a well compacted layer of bajri, gravel, stone spawl or moorum in layers of 4 to 6 inches (whatever specified). This backing shall be carried up simultaneously with the face work unless otherwise specified.

8.16.4 Thickness

The thickness of pitching shall be as actually specified; the stone of size slightly larger than specified thickness need not be dressed off to get a uniform surface, (The rougher the pitching surface the better it is for wave: wash.)

8.16.5 Laying

The stone shall be laid closely in position and firmly bedded; the length shall be perpendicular to the face of pitching.

8.16.6 Boulder Pitching

When pitching with boulder stone is specified the minimum size of the boulders shall depend upon the thickness of pitching specified (generally 10-15 inches). All boulders less than the minimum size shall be rejected.

8.16.7 Size of Boulder in Grouted Pitching

Minimum size of boulder used in this type of pitching shall range between 1.5 feet and 2 feet, unless otherwise specified.

8.16.8 Laying of Boulders

Boulders shall be laid so as to fit into one another as closely as possible and on no account shall be so laid as to have all the wale coils down and the taper ends up.

8.16.9 Grouting in Boulder Pitching

All pitching of this kind shall be bedded upon large shingle free from sand and to be thoroughly grouted with specified grouting mixture.

8.16.10 Measurements

The pitching of stone or boulders shall be measured by volume. The unit of measurement shall be cubic feet.

8.16.11 Rates

The unite rate shall be including the laying of sub-grade and the pitching of stone or boulders, as per above Specifications.

Contents

CHAPTER 9	ROOFING	7
9.1	General	8
9.1.1	Glossary of Terms	8
9.1.2	Truss or Framework	11
9.1.3	Pitch	12
9.1.4	Roof Covering	12
9.1.5	Roof Drainage	16
9.1.6	Comparison and Use of Roofing Material	16
9.2	First Class Tile Roofing	19
9.2.1	Scope	19
9.2.2	Operation	19
9.2.3	Materials	19
9.2.4	Laying of Beams & Battens	19
9.2.5	Sloop to Roof	20
9.2.6	Laying of First Layer of Tiles	20
9.2.7	Laying of second Layer of Tiles	20
9.2.8	Cement Plaster to Parapet	20
9.2.9	Bed for Bituminous Coating	20
9.2.10	Earth filling and Mud Plaster	20
9.2.11	Khuras	21
9.2.12	Pointing of Tiles Underneath	21
9.2.13	Filling Spaces Between Battens	21
9.2.14	Painting with Preservatives	21
9.2.15	Measurements	21
9.2.16	Rates	21
9.3	Second Class Tile Roofing	22
9.4	Jack Arch Roofing	23
9.4.1	Scope	23
9.4.2	Operation	23
9.4.3	Rise of Arch and Type	23
9.4.4	Painting of Steel	23
9.4.5	Laying of Tie Bars and Wall Plates	23
9.4.6	Supporting of Centering	23
9.4.7	Precaution against Displacement	23

9.4.8	Building of Arch.....	24
9.4.9	Spring Course.....	24
9.4.10	Key.....	24
9.4.11	Slope.....	24
9.4.12	Filling of Haunches and Crown.....	24
9.4.13	Bed for Bituminous Coating.....	24
9.4.14	Earth filling and Mud Plaster.....	25
9.4.15	Plastering of Soffits.....	25
9.4.16	Plastering Bottom Flanges of Beams.....	25
9.4.17	Measurement.....	25
9.4.18	Rates.....	25
9.5	Jack Arch Roofing (Sprung from Top of Beams).....	25
9.6	Jack Arch Roofing (For Carrying Flooring of the Rooms).....	26
9.6.1	Description.....	26
9.6.2	Measurements.....	26
9.6.3	Rates.....	26
9.7	Flat Steel Sheet Roofing.....	27
9.7.1	Scope.....	27
9.7.2	Materials.....	27
9.7.3	Roofing Boarding.....	27
9.7.4	Roll Battens.....	27
9.7.5	Preparing Sheets.....	27
9.7.6	Laying Sheets.....	27
9.7.7	Preparing and Fixing Rolls.....	28
9.7.8	Ridge Sheeting.....	28
9.7.9	Ridge Roll.....	28
9.7.10	Laps.....	28
9.7.11	Wood Preservative.....	28
9.7.12	Bending by Machine.....	28
9.7.13	Hips, Valleys, Gutters and Flashings.....	28
9.7.14	Measurements.....	28
9.7.15	Rates.....	29
9.8	Galvanized Corrugated Steel Sheet Roofing.....	30
9.8.1	Scope.....	30
9.8.2	Materials.....	30
9.8.3	Lap.....	30

9.8.4	Insulating Material.....	30
9.8.5	Purlin Spacing.....	30
9.8.6	Hole.....	30
9.8.7	Laying of Sheet.....	31
9.8.8	Fixing Sheets.....	31
9.8.9	Ridges and Hips.....	31
9.8.10	Special Fastening Against Cables.....	31
9.8.11	Painting of Sheets.....	31
9.8.12	Measurements.....	31
9.8.13	Rates.....	32
9.9	Corrugated Asbestos Cement Sheet Roofing.....	33
9.9.1	Scope.....	33
9.9.2	Materials.....	33
9.9.3	Lap.....	33
9.9.4	Overhanging.....	33
9.9.5	Purlin Spacings.....	33
9.9.6	Holes.....	33
9.9.7	Laying of Sheets.....	34
9.9.8	Fixing Sheets.....	34
9.9.9	Ridges Cap.....	34
9.9.10	Painting.....	34
9.9.11	Measurements.....	34
9.9.12	Rates.....	34
9.10	Half Sawn Sleeper Roofing.....	35
9.10.1	Scope.....	35
9.10.2	Material.....	35
9.10.3	Composition.....	35
9.10.4	Ceiling.....	35
9.10.5	Painting.....	35
9.10.6	Measurement.....	35
9.10.7	Rate.....	35
9.11	“Khurras” Parnalas” and Spouts.....	36
9.11.1	Khurras.....	36
9.11.2	Parnalas.....	36
9.11.3	Spouts.....	37
9.11.4	Roof Drains.....	37

9.11.5	Measurements.....	37
9.11.6	Rates.....	37
9.12	Gutters and Flashing.....	37
9.12.1	Description.....	37
9.12.2	Materials	37
9.12.3	Gutters	38
9.12.4	Flashing.....	38
9.12.5	Measurements.....	38
9.12.6	Rate.....	38
9.13	Sleeper Roofing.....	39
9.13.1	Scope.....	39
9.13.2	Composition	39
9.13.3	Materials	39
9.13.4	Laying.....	39
9.13.5	Spans.....	39
9.13.6	Measurement.....	39
9.13.7	Rate.....	40
9.14	Treatment of Roof Slab.....	41
9.14.1	Description.....	41
9.14.2	Materials	41
9.14.3	Construction Requirement	41
9.14.4	Measurement.....	42
9.14.5	Rate.....	42
9.14.6	Bituminous Membrane Water Proofing Method.....	42
9.15	Thermal Insulation of R.C.C Roof.....	44
9.15.1	Description.....	44
9.15.2	Materials	44
9.15.3	Composition of Thermal Insulation of Roof.....	44
9.15.4	Construction Requirement	44
9.15.5	Measurement.....	46
9.15.6	Rate.....	46
9.15.7	Spray Foam Insulation (Sprayed Polyurethane Roof Treatment)	46
9.15.8	Extruded Polystyrene Board Roof Treatment System	49
9.16	Plastic Roofing (Fiber Glass Roofing).....	52
9.16.1	Scope.....	52
9.16.2	Materials	52

9.16.3	Roof Construction	52
9.16.4	Measurement	53
9.17	Cast Iron Pipes for Rain Water	55
9.17.1	Cast Iron Pipes& Filling	55
9.17.2	Dimensions	55
9.17.3	Fixing and Jointing	56
9.17.4	Measurements	57
9.17.5	Cast Iron Accessories for Rain Water Pipes	57
9.18	UPVC Pipes for Roof Drain	59
9.18.1	Jointing Methods	59
9.18.2	Measurement	59
9.19	False Ceiling (General)	60
9.19.1	Description	60
9.19.2	Material	60
9.19.3	Operation	60
9.19.4	Measurement	60
9.19.5	Rate	60
9.20	Ceiling with Thermophore	62
9.20.1	Thermophore Sheets	62
9.20.2	Frame	62
9.20.3	Nails	62
9.20.4	Fixing	62
9.20.5	Finishing	62
9.20.6	Measurement	63
9.21	False Ceiling with Gypsum Board	64
9.21.1	Description	64
9.21.2	Materials	64
9.21.3	All Other Respects	64
9.21.4	Measurement	64
9.21.5	Rate	64
9.21	False Ceiling with Plaster of Paris	65
9.21.1	Description	65
9.21.2	Materials	65
9.21.3	All Other Respects	65
9.21.4	Measurement	65
9.21.5	Rate	65

9.22 False Ceiling with HDF Boards	66
9.22.1 Description	66
9.22.2 Material	66
9.22.3 All Other Respects	66
9.22.4 Measurement	66
9.22.5 Rate	66
9.23 Wooden Ceiling	67
9.23.1 Boards	67
9.23.2 Frame	67
9.23.3 Mild Steel Screws	67
9.23.4 Fixing	67
9.23.5 Finishing	67
9.23.6 Measurement	68
9.24 Metallic Ceiling	68
9.24.1 Material	68
9.24.2 Construction Requirement	68
9.24.3 Measurement & Rate	68

CHAPTER 9 ROOFING**References:**

Sr.#	Standard Name	Description
ASTM		
1.	ASTM D-449-89	Standard Specification for Asphalt Used in Damp proofing and Waterproofing.
2.	ASTM C-518	Standard Test Method for Steady-State Thermal Transmission Properties by Means of the Heat Flow Meter Apparatus.
3.	ASTM D 1621	Standard Test Method for Compressive Properties of Rigid Cellular Plastics.
BS		
4.	BS 5241-part 1	Rigid polyurethane (PUR) and poly isocyanurate (PIR) foam when dispensed or sprayed on a construction site. Specification for sprayed foam thermal insulation applied externally.
5.	BS 4370 Part 1	Methods of test for rigid cellular materials. Methods 1 to 5.
6.	BS 4370 Part 2	Methods of test for rigid cellular materials. Methods 7 to 9.
7.	BS 4370 Method 13	Methods of test for rigid cellular materials. Methods 12 and 13.
8.	BS 3837 Part 1 1986	Expanded polystyrene boards. Specification for boards manufactured from expandable beads.
9.	BS EN 573-3:2013	Aluminum and aluminum alloys. Chemical composition and form of wrought products. Chemical composition and form of products.
10.	BS 78	Specification for cast iron spigot and socket pipes (vertically cast) and spigot and socket fittings.
11.	BS 1211	Specification Centrifugally cast (spun) iron pressure pipes for water, gas & sewage.
12.	ISO 3633 and EN 1329	Plastics Piping Systems for Soil and Waste Discharge (Low and High Temperature) Inside Buildings - Plasticized Poly (Vinyl Chloride) (PVC-U)

9.1 General

9.1.1 Glossary of Terms

Roof: The covering or the upper part of a building constructed to preserve it from exposure to weather is known as roof.

Type of roofs: Roofs can be broadly be divided into following major types:

Flat roofs: The so called flat has a small slope to drain water from the roof. The various flat roofs commonly used are as under:

Jack Arch Flat Roof:

It is constructed in the form of small span brick arches over R.S. Joist*s. These joists rest on walls and spandrels are fitted by cheap inert materials such as lean concrete.

Terrace roof:

The roofing consists of R.C.C. steel joist or wood beams resting over bed plate on the wall. The opening between joists is spanned by wooden joist or steel T-sections over which the terrace bricks or clay tiles.

R.C.C. slab roof:

Roof comprises of reinforcement cement concrete structural members like beams & slab or simply slab.

Pitched roofs:

A pitched roof is composed of a framework and roof covering. Frame generally known as trusses are placed at suitable distances spanning the two supports. Terms related to pitch roofing are as under:

Abutment: The sloping intersection of a roof surface with a part of the structure which rises above.

Barge board: A member, usually of timber, fixed along the edges of a gable and covering the ends of the horizontal roof members.

Battens: Horizontal timber members of small section on which tiles or slates may be laid. They are sometimes termed tile or slate battens, or tile or slate laths.

Bedding: The laying of tiles or slates in mortar.

Counter battens: Timber members of small section fixed at right angle or obliquely to the direction of the battens between them and the surface below.

Dormer: A vertical window formed in a sloping roof.

Eaves:	The lower edge of an inclined roof.
Flashing:	A strip of flexible impervious material, usually metal, used to exclude water from the junction between a roof covering and another part of the structure.
Apron Flashing:	A flashing whose lower edge is dressed over the roof covering.
Cover flashing:	A flashing, used in conjunction with other components such as soakers, the vertical parts of which it overlaps.
Raking flashing:	A flashing at an abutment, its upper edge being secured into the horizontal joints of brickwork or masonry and stopped up the slopes from course to course.
Gable:	The part of a wall above the general eaves level at the end of a ridged or partially hipped roof.
Gauge:	The distance from the line of fixings of a course of slates or tiles to the fixing of the course below.
Gutter:	Any form of roof water channel.
Hip (Piend, Scottish):	The sloping intersection of two inclined roof surfaces which meet at a salient angle.
Hip Iron or Hip Hook (Piend Strap Scottish):	A metal strap bent to form a stop for the hip covering screwed to the lower end of a hip rafter.
	i) General The distance that one course of slates or tiles covers the course next but one below it.
	ii) Slate head-nailed with a single nail The distance that one course of slate covers the course next but one below it, less the distance of the nail hole from the slate head.
	iii) Single lap tiling The distance that one course of tiles covers the course next below it.
Mansard:	A roof with two pitches on each side of the ridge, the steeper commencing at the eaves and intersecting with a flatter pitch finishing at the ridge. The term is sometimes used for a roof with steeply pitched slopes surmounted by a flat.
Margin:	The distance from the lower edge of a slate or tile to the lower edge of the course immediately above.
Pitch:	The angle of inclination with the horizontal of the rafters or the surface on which slates or tiles are laid.

Ridge:	The intersection of two inclined surfaces at the apex of a roof.
Slate back:	The upper surface of a slate as normally laid.
Slate Fillet:	Slates fitted to form a fillet as an alternative to flashings.
Slate Head:	The upper edge of a slate when laid.
Slate Tail:	The lower edge of a slate when laid.
Soaker:	Flexible members, usually of metal, lapped with slates or tiles and bent to form a watertight joint, as for example at abutments where it is used in conjunction with cover flashings, or at mitred hips, valleys and angles.
Tile Fillet:	Tiles cut and fitted to form a fillet as an alternative to flashings.
Tilting Piece:	A fillet, usually of wood, used at eaves or at open valley gutters to support the slates in the correct position relative to the roof surface.
Top Edge:	The upper edge of a roof surface finishing at a ridge or against a part of the structure which rises above the roof surface.
Torching:	The mortar pointing to the heads and/or the side joints on the underside of the tiles or slates.
Undercloak:	A course or courses of tiles or slates laid under the bedding of slating or tiling at a verge.
Valley:	The sloping intersection of two inclined roof surfaces at a re-entrant angle.
Valley, laced:	A valley in which the courses are not horizontal, each course being swept up to a tile and a half, or slate and a half, laid aslant on a wide board in the valley.
Valley, mitred:	A valley at which the tiles or slates of each course are mitred.
Valley, swept:	A valley in which tiles or slates, made or cut to a taper, sweep round in horizontal courses.
Types of pitched roofs:	Shed roof: It slopes in one direction. This type is used generally on a temporary structure where appearance is not

important and where it cannot be seen in connection with other types to form a 'lean to'.

Gable roof:

It slopes in two directions. This type of roof is widely in use in big halls of cinemas, auditoriums, etc. The most common slopes are between 1:2 to 1:1.

Hip roof:

It slopes in four directions. This type of roof is widely in use. Its slope varies similarly as in case of gable roof.

Gambrel roof:

It slopes in two directions but there is a break in the slope on each side. This roof is used for houses on account of efficient use which can be made of the space under the roof.

Mansard roof:

It slopes in four directions, but there is a break in the slope.

Deck roof:

It slopes in four directions, but has a deck at the top.

Sawtooth roof:

It is used quite extensively in industrial buildings on account of the advantage of sufficient light and good ventilation that it offers. The steep vertical faces as shown in figures are mostly glazed and are kept towards the north.

Shell roof:

In case of very large openings and massive structures such as theatres, factories, assembly halls etc. RCC shell roofs are becoming extremely popular because of the comparatively thin section which results in considerable reduction of dead load. The shell is designed as a membrane and hence it is free from large bending stress.

Dome roof:

Domes are similar in construction to shells in which also very small RCC section provide roof covering over very large area within certain height and diameter ratios. They are particularly constructed from architectural consideration, in moments and other similar buildings.

9.1.2 Truss or Framework

A framework or a truss is an assemblage of bars; or members forming a structure to carry transverse load, and under vertical load as vertical reaction. The bars or members are so jointed together at their ends that they bear only direct tension or compression when the external load is applied at the joints.

Trusses are designed to support the roof and snow-loads and to withstand wind pressure and occasionally to support a false ceiling or lower floors which are hung from the truss by means of hanger rods. The general bay length i.e. distance from centre to centre of the two adjacent trusses, varies from 10 to 16 foot. In general, bay length is 10 feet in a span truss of up to 50 feet and beyond that 1/5 of the span. Purlins are placed at or near panels points which are the joints of top chords, so as not to cause flexure in the top chord members. Purlins are placed with their sides either vertical or at right angle to the main rafters.

Trusses are used to support roofs spanning openings up to 20 feet to 200 feet. For span exceeding 200 feet arches are generally used. These trusses are made of wood, steel or partly wood and partly steel. Wood is not used for trusses where the span exceeds 60 feet; instead they are made of steel. In fact, with advanced process of manufacturing steel and its consequent cheapness and reliability steel trusses are now being preferred to the wooden trusses. They are more economical for span exceeding 40 feet.

9.1.3 Pitch

The pitch of a roof is the ratio of the rise to the spanned length. The minimum pitch for each of the most common roofing materials are as follows: -

- ¼ for slates and tiles.
- 1/5 for corrugated sheets.

9.1.4 Roof Covering

The following are the most common roof covering materials used in the construction of a sloping roof:

- Thatch
- Allahabad tile
- Manglore tile
- Galvanized corrugated steel sheet
- Corrugated asbestos cement sheet
- Slates

9.1.4.1 Thatched Roof

It is composed of bamboo framing which consists of vertical bamboos 1½ inches in diameter and 1 foot apart to which split bamboos are securely fastened at right angles 6" apart. Thatch is from 6 to 12 inches thick and laid in 3 inches layers. The first layer is generally attached to the bamboo framing before it is placed on the roof. The pitch of the roof is usually about 35 degrees. Thatch gives a watertight covering when skillfully applied. It has, however, several serious demerits, the most important of which are its combustibility and its tendency to become infested with vermin's. the life of straw thatch is not more than fifteen years.

9.1.4.2 Allahabad Tile Roof

It is composed of special moulded brick tiles (called Allahabad tiles) laid in layers (either single or double) over battens placed 12 inches apart, centre to centre running along the length of roof and placed above common rafters of the roof trusses placed at suitable distance apart on the walls of a room. The lower flat tiles are laid on battens. The lowest eave battens are kept deeper than the battens above so that the line of the tile form ridge to the eaves is continuous. Battens are placed at 12 inches intervals and their size is 1-inch x 1¼ inches. The three lowest tiles in each course of each layer as well as ridge and hip tiles are set in mortar. Unless special

eave tiles with closed ends are used, the ends of each row of semi-hexagonal and semi-circular tiles are stopped with mortar. In the case of double tiling, the spaces between the two rows of flat tiles are also filled. Tiles in contact with mortar are soaked in water mixed with cow dung for at least 6 hours before laying, a dry tile should not absorb water more than 1/6" of its weight when immersed in water for one hour. The general values of pitch in case of Allahabad tile roofing varies from 1:3 to 1:2. The barge boards are kept about 2 inches to 3½ inches higher than the eaves board for the single layer tiling system and about 5 inches to 6 inches higher for the double layer of tiling system so as to cover the end row of tiling.

9.1.4.3 Mangalore Tile Roof

It is made up of special moulded tiles (Manglore tiles) laid over wooden battens placed at 12½ inches apart, centre to centre running along the length of roof and on common rafter of roof trusses placed at suitable distance over the walls of room. The roof generally pitches at a slope 1:3 to 1:2. The size of a Manglore tile is about 16 inches x 9½ inches. The effective size after allowing for laps etc., however, is 12½ inches x 8¼ inches. Usually 150 tiles are required for each 100 square feet of roofing. The weight of 1000 tiles is about 2½ tons. Each flat tile usually weighs about 5-5/8 lbs when dry, and each special ridge tile (about 16 inches long) weighs 7½ lbs when dry.

The tiles are laid by breaking joint, i.e. the left channel of the upper tile lies in the rights of that below, and fits properly one to another, the "catches" resting fully against battens, with usually sizes as 1¾ inches x 1 inch or 2 inches and run parallel to the eaves. The lowest battens nearest to the eaves are fixed about 10 inches from the one immediately above, and have got double the ordinary thickness. Special tiles are used for ridges, hips and valleys, and all these tiles at gable ends are set in cement mortar. Tiles to be set in cement are immersed in water for four hours before they are laid. They must not absorb water more than one-sixth of their weight when immersed in water for one hour. In exposed situations and at all gable ends, eaves and places where the tiles are not readily accessible, they are secured to the battens by No. 18 gauge galvanized soft iron wire passing through the holes provided for the purpose in the underside of the tiles. A tile should have a breaking strength of not less than 2 ewts if a load is applied at centre of span when supported on battens at 12½ inches apart centre to centre.

9.1.4.4 Galvanized Corrugated Steel Sheet Roof

This type is used primarily for roofs of factories, industrial plants, sheds, huts, etc. The material often combines the functions of both roof covering and ceiling and can be applied with a minimum of skill.

The sheets are manufactured in a number of gauges, widths and lengths. They are generally 26 inches and 32 inches wide and 8 feet and 10 feet long respectively. The thickness in common use varies from 1/24 inch for 24 gauge, to 1/16 inch for 16 gauge. The gauge of sheets depends upon the spacing of the supports, the load to be carried and the quality of the building. The type commonly used are bare corrugation 2½ inches wide, 5/8-inch-deep, and 3 inches wide ¾ inch deep.

These sheets may be nailed to wood sheathing or supported directly by wood or steel purlins spaced usually at 3 feet to 5 feet apart. They are lapped 1¼ inches or 2 inches corrugations on the sides, and 6 inches or 8 inches on the ends depending upon the slope of the roof. For flat slope or building exposed to heavy rains, greater end laps and sealing them with mastic is required. Where steel purlins are used, they may be provided with nailing strips to which the corrugated steel sheets are fastened below or the sheet may be held in place by straps passing around the purlins and riveted to the sheet on each side of the purlin. Long malleable nails called clinch nail may be driven through the sheet and clinched around the purlins.

These sheets are fixed through the crowns of the corrugation also by hook bolts, screws and nail with curved G.I. washers and bituminous washer. For fixing bolts, the holes are punched in the crown of corrugation which are usually made 1/16 of an inch larger in diameter than bolts. Washers made up of bituminous flat are also used for waterproofing purposes. Since steel is a very good conductor of heat, it may be necessary to provide some form of lining for building where wood sheathing is not used and which are to be heated in which the condensation of moisture on the underside of them is to be prevented. This anti-condensation lining usually consists of a layer of wire netting placed directly on the purlins and one or two layers of asbestos paper placed on the wire netting. The corrugated sheet is placed over the lining. The wire netting holds asbestos paper in place and protects it.

9.1.4.5 Corrugated Asbestos Cement Sheet Roof

Manufactures in various sizes they are now in extensive use as a roof covering material in the construction of buildings. A sheet having a depth of corrugation under 2 inches is known as small section sheet and more than 2 inches as large section sheet. The centre of corrugation in small section is about 3 inches whereas in large sections it is 6 inches. "Big six" corrugated sheets and "Terafford Sheets" are usually used for roofing purposes. The following table gives particulars of the two types: -

Description	"Big six" Corrugated Sheet	"Terafford" Sheet
Standard lengths	5'6"7'8'9'10	5'6"7'8'9'10
Overall width	3'-5½"	3'-7/16"
Laid width	3'-3¾"	3'-4"
Cover efficiency	95.79%	92.89%
Purlin spacing	5'-6" (Max)	5'-6" (Max)
Spacing of rails for side cladding	6'-6" (Max)	6'-6" (Max)
Horizontal lap (for slopes not less than 21½°)	6"	6"
Actual cover of 10 feet sheet as laid 100 sq.ft. laid areas required of sheeting (on basis of 5 percent less by end laps)	31.47 sq.ft.	31.76 sq.ft.
Weight of 100 sq.ft. as laid approximately Colours available	109.90 sq.ft. 357 lbs Natural Grey	113.31 sq.ft. 332 lbs Natural Grey

Table 1, Corrugated Sheet Properties (Chapter 9)

These sheets are laid in somewhat the same manner as corrugated steel sheets. The spacing of the purlin in the case of small section sheets in 3 feet and in the case of large sections it is generally 4½ feet to 5½ feet.

These sheets are laid with the smooth side upward and with a side lap of half corrugation and end lap of 6 inches. Holes for fixing sheets are always drilled and never punched. The diameter of a hole is drilled 1/16 of an inch larger than that of the bolt. These sheets are secured to the purlin through their crown by hook bolts with G.I. washer and bituminous washers. The diameter of a hook bolt varies from ¼ of an inch to 5/16 of an inch. Nuts and screws are screwed lightly at first and tightened when a dozen sheets have been laid. The laying of sheet always starts from the eaves end. If the sheets are laid from left to right the first sheet is laid uncut, and the remaining sheets in the bottom rows will have the top left-hand corner cut or mitred. The sheets in the second and other intermediate rows will have both the top left-hand

corner and bottom right-hand corner cut. With the exception of the first sheet in each row which only have the bottom right hand corner cut and the last sheet in each row will have only the top left-hand corner cut, the last or top row sheets will have the bottom right hand corner cut with the exception of the large sheet which is laid uncut. The mitre is cut from a point 6 inches up the vertical side of a sheet to a point 2 inches along the horizontal edge.

As these sheets are liable to be damaged or cracked, roof ladder or planks are always used when the workmen walk over them. Since they cannot take excessive stress care should be taken while fixing purlins that the limit of safe span is not exceeded. Additional joist are fixed where excessive loads are likely to be put on, such as for the repair of ventilators and chimneys.

9.1.4.6 Slate Roof

It is made from the natural rock which is split and shaped into rectangular pieces of the desired dimensions. Slate for roofing is hard and tough and has a bright metallic luster when freshly split. It rings clear when supported horizontally on three fingers and snapped with the thumb of the other hand.

Slate is available in a great variety of colours; grey, green, dark-blue, purple, red. It is furnished in about any size from 6 to 14 inches wide, 12 to 24 inches long and 1/8 inch to 2 inches thick. The common sizes are 12 x 16 inches and 14 x 20 inches; 3/16 and 1/4 inches thick.

Roofs may be made of pieces of uniform sizes and thickness and colours, although generally random sizes, thickness and colours are used.

Slate may be laid by each course lapping 3 inches over the second below or they may be laid at random. Care may, however, be taken to give sufficient lap. They are nailed to wood sheathing or nailing strips. Or gypsum blocks, holes being punched in the slate at the factory. A layer of roofers felt is used between the slate and the sheathing. The nails are of copper or yellow-metal Slater's nails, although re-dipped galvanized nails and copper coated nails are commonly used.

Slates may be supported directly on steel sub-purlins to which they are wired. Slate roofs are used on slopes less than 6 inches vertical to 12 inches horizontal. These roofs are fire proof, durable and attractive, and may be classed as expensive.

9.1.4.7 Khaprail Tile

9.1.4.7.1 Scope

This work should include of supplying and fixing of khaprail tiles of approved quality for roof covering as per the directions of engineer in charge.

9.1.4.7.2 Materials

Tiles: tiles of approved quality having size not less than 6x9 inch and thickness not less than 3/8 inch.

9.1.4.7.3 Construction Requirements

- Khaprail tile should be laid on a bedding of approved material with 1:3 cement sand mortar.

9.1.4.7.4 Measurement & Payment

Measurements should be taken in square feet unit and shall be paid accordingly.

9.1.5 Roof Drainage

Rain water may be allowed to run off and drip from the projecting eaves, but it is desirable to collect the water in gutters placed along the eaves of sloping roofs. The water is then carried off by the vertical pipes called downspouts, conductors or leaders. Flat roofs or other roofs which do not have projecting eaves are drained by means of downspouts or conductors placed to pints where the water is carried by the slight slope provided in the roof. The size of the gutters and conductors is determined by the contributing area and by the intensity of rainfall.

The hanging gutter is the simplest form, but is not as attractive as the crown-mould gutter or the wood gutter which fits into the design of the cornice. The standing gutter or V-Gutter is inconspicuous and easily constructed but the concealed gutter is quite expensive. Gutters are sometimes called eaves troughs. Cornices which are enclosed so that the rafters do not show are called open cornice.

Conductors or downspouts should be provided with strainers at their upper ends, so that leaves, sticks and other debris cannot clog them. At very cold places it is desirable to run conductors down inside the building rather than to place them on the outside walls as the heat of the building keeps them from freezing. They may be placed in chases in the outside walls, along columns, or in partitions. If they are placed on the outside of outside walls, they should be kept away from north walls, if possible. Steam outlets are frequently provided in exposed conductors so that steam can be discharged into them to avoid freezing. Clean-outs should be provided so that clogged conductors and the connecting drains can be easily cleaned. Exposed conductors are commonly made of copper and galvanized steel, and copper, cast iron and steel pipes are used for concealed conductors or where appearance is not a factor.

Where a roof surface meets a vertical wall, it is necessary to provide flashing to make the joint watertight. Flashing usually consists of strips of some sheet metal such as copper or galvanized iron which is made L-shaped so as to fit over the joint one leg of the "L" running up the wall and the other along the roof. Rain water which is derived against the vertical face of the wall is kept from running down behind the vertical leg of the flashing by counter flashing or cap flashing, also made in the form of an "L". the "L" is inverted, the horizontal leg being built or fitted into a mortar joint and the vertical leg fitting over the flashing. Built up roofing is commonly flashed without the use of sheet metal. To avoid the sharp corner between the wall and the roof, cant strips or boards or concrete cants are commonly used. Flashing blocks, as shown in the figure, are frequently used. The angle between the back side of a chimney or other projection, and a sloping roof is usually protected with a saddle or cricket which consists of two sloping surfaces meeting in a horizontal ridge perpendicular to the chimney. The valleys on sloping roofs are made watertight by sheet metal strips bent to fit the two intersecting roof surfaces. Roll roofing is often used on valleys on asphalt shingle roof.

9.1.6 Comparison and Use of Roofing Material

The factors which must be considered in the selection of a roof covering are: -

- Slope of roof.
- Durability
- Initial cost.
- Maintenance cost.
- Resistance to fire.
- Weight
- Type of roof construction
- Appearance

The relative importance of these factors will vary with different types of buildings.

1. Slope of Roof

All forms of tiles and slates require a medium slope 1:2. Corrugated sheets should not be used on a slope less than 1:3. Sheets metal roof may be used on practically any slope flat or steep.

2. Durability

The life of any roofing material depends upon so many variable factors that it is useless to give anything more than comparative figures. The following classifications will give an idea of relative durability.

- Long Lived: Clay Tile, slates, copper, zinc and lead.
- Medium Lived: Asbestos cement sheet and cement tiles.
- Short Lived: Corrugated iron sheet.

Various destructive agents must be considered in connection with durability. Tiles and slates may break if walked upon, for instance, during repairs; slate tiles may suffer severely in hailstorm. Corrugated iron sheet is vulnerable to corrosive gases and salt air. Winds have serious effect on tile roofing.

3. Initial Cost

The initial cost of roofing materials varies from time to time and with locality to locality. In determining the cost of a roof covering the indirect cost due to effect of weight on the cost of supporting structure must be considered.

The cost of preparing the supporting structure to receive the roofing has also to be taken into account.

4. Maintenance Cost

Certain classes of roofing materials have to be maintained continually in the form of painting; other, only require repair when dinged by necident or wind storm; whereas on building there is practically no expenditure for maintenance. The following classification gives the relative cost of maintenance: -

- Frequent painting or repairs: - Corrugated steel, tile, etc.
- Occasional repairs: - Clay tile, Slate, Cement asbestos sheets, etc.

5. Resistance to Fire

The actual resistance of the roof covering to fire is of more importance when the supporting structure is made of timber than when it is of fire proof construction. Cement asbestos roof covering will withstand quite severe fire exposure while tile roofing and slates are less resistant.

6. Weight

If a roofing material is to be replaced by another, the weight may often become determining factor in the choice of materials on account of the strength of the roof construction already in place. The weight of a given roofing material depends upon its design, its thickness and other

factors. The following are weights in pounds per 100 square feet which give an idea of relative values: -

- Clay tile 1000 to 2000 lbs.
- Slate 500 to 1000 lbs.
- Galvanized steel 125 to 200 lbs.
- Asbestos cement 400 to 700 lbs.

7. Type of Roof Construction

The methods used in fastening the various roofing materials to the supporting roof construction make it necessary to consider the nature of construction in selecting a roof covering.

Where roof coverings are to be laid directly on the members of the structural frame without sheeting or other material to form a continuous surface, it is necessary to use corrugated steel or zinc sheets. Where suitably spaced sub-purlins or rafters are provided, tile or slate covering are the most suitable.

8. Appearance

If the roof is exposed to view, the material will be selected to harmonize with the remainder of the building giving due care to the factors in the above paragraphs. In high class buildings and residences, clay tile slates and asbestos roof coverings may be considered the most suitable. In cheapest class of building corrugated steel roofing may be used and in industrial where appearance is of less importance than durability corrugated sheet roof covering is suitable.

9.2 First Class Tile Roofing

9.2.1 Scope

Unless otherwise specified, first class tile roofing work shall be constructed according to following Specifications.

9.2.2 Operation

The first-class tile roofing shall consist of: -

- First layer of tiles laid in 1:6 cement sand mortar or 1:2 lime surkhi mortar resting on battens.
- Second layer of tiles in 1:6 cement sand mortar or 1:2 lime surkhi mortar laid over a bed half an inch thick 1:6 cement sand mortar.
- Half an inch thick 1:6 cement sand plaster over second layer of tiles.
- A coat of hot bitumen blinded with sand.
- Four inches earth filling finished with 1-inch mud plaster with gobri leeping.

9.2.3 Materials

9.2.3.1 Tiles

Unless otherwise specified, tiles used in both the layers shall be of size 12"x6"x1¼" and shall conform to heading 4.2.1 of Chapter-4 of Book-1 (specifications for Engineering Materials) of these specifications.

9.2.3.2 Clay

Clay used in earth filling shall conform to Chapter-3 of Book-1(Specification for Engineering Material).

9.2.3.3 Bitumen

Bitumen shall conform to Chapter-12 of Book-1(Specification for Engineering Material).

9.2.3.4 Mud Mortar

It shall conform to 5.2.1 of Chapter-5 of these specifications.

9.2.4 Laying of Beams & Battens

The beams and battens shall be of specified type and size shall have proper finished surface on top so as to give a good bearing to the tile. They shall be spaced 12 inches apart center to center and shall be placed in straight and parallel lines.

9.2.4.1 Types of Beams & Battens

Wood:

Wood of beams and battens shall be as specified in BOQ of the work. Wood shall conform to Chapter-8 of Book-1(Specification for Engineering Material).

Steel:

Steel section shall be as given in BOQ of the work. Steel shall conform to Chapter-10 of Book-1 (Specification for Engineering Material).

Precast Concrete Members:

These shall conform to 6.12 "Pre-Cast Concrete Members" of these specifications.

9.2.5 Sloop to Roof

The necessary main slope in the roof shall be formed by sloping the beam or battens.

9.2.6 Laying of First Layer of Tiles

Over the battens the first layer of tiles shall be laid in mortar with the joints coming over the center of the battens. Tiles shall be laid straight and square. All vertical joints shall be as fine as possible.

9.2.7 Laying of second Layer of Tiles

The second layer of tiles shall then be laid in specified mortar on half an inch-thick bed of specified mortar spread over the first layer of tiles. The joints shall be broken in both directions with the first layer of tiles laid underneath. The vertical joints shall be as fine as in the case of first layer of tiles and shall be flushed with mortar at top.

9.2.8 Cement Plaster to Parapet

The portion of the parapet wall between the tiles and drip course shall be plastered with half an inch-thick cement sand plaster of 1:3 ratio, unless otherwise specified.

9.2.9 Bed for Bituminous Coating

Half an inch-thick cement sand plaster of specified ratio shall then be laid over the surface of the second layer of tiles to serve as a bed for bitumen.

9.2.9.1 Curing of Bed

The bed shall be cured for seven days, and the surface shall then be allowed to dry thoroughly before bitumen is laid.

9.2.9.2 Application of Bitumen Thickness

Bitumen shall be heated to a temperature specified by the manufacturer and poured on the surface to be treated and pulled out so that the minimum thickness is 1/16 of an inch. The coat of bitumen shall be continued along with the parapet wall.

9.2.9.3 Binding of Bitumen Coating

The bitumen coat shall be blinded with sand at the rate of one cubic foot per 100 square feet of the surface area.

9.2.10 Earth filling and Mud Plaster

Four inches thick of good earth (clay) shall then be put and thoroughly rammed and watered. The roof shall be finished with one-inch thick mud plaster with gobri leeping which shall be done in accordance with the specifications. This shall be done before laying the drip to ensure a close joint with the wall.

9.2.11 Khuras

Khurras shall be made before the earth is laid and shall be in accordance with the specifications.

9.2.12 Pointing of Tiles Underneath

Unless otherwise specified, on the completion of the work the underside of the tiles shall be washed and neatly pointed with 1:2 cement sand mortar.

9.2.13 Filling Spaces Between Battens

In case of wooden battens, the spaces over the beam and between the battens shall be closed by one-inch planks nailed to distance pieces which in turn are nailed to the battens. Where concrete battens have been used the spaces shall be filled with 1:3:6 cement concrete block of exact size and laid in spaces with 1:3 cement sand mortar. The filling shall be equal to the battens in height and the outer faces shall be exactly in line with the edge of the beam.

9.2.14 Painting with Preservatives

The top surface of wooden battens in contact with the tiles and the end shall be painted with an approved preservative.

9.2.15 Measurements

First class tile roofing shall be measured by the superficial area of the roof. The unit of measurement shall be 100 square feet or square meter.

9.2.16 Rates

9.2.16.1 Labor Rates

The unit rate shall include: -

- (a) Laying of first layer of tiles in specified mortar on battens.
- (b) Laying of second layer of tiles in specified mortar over half an inch-thick bed of specified mortar.
- (c) Laying of half an inch-thick cement sand plaster over second layer of tiles.
- (d) Laying of coat of hot bitumen blinded with sand.
- (e) Laying of 4-inch earth filling finished with 1-inch mud plaster with gobri leeping.
- (f) Cement plastering portion of parapet against which mud plaster and earth filling butt.
- (g) Pointing the underside of the tiles with specified mortar.
- (h) Filling spaces between battens over the beam.
- (i) Providing, using and removing scaffolding, staging, ladders, supports and other tools and plants required for carrying out the work as per above specifications. It shall also include making good of any damaged portion of the walls or other structure on which the roof is being laid.

NOTE: The rate does not include labour required for the construction of khurras or any other kind of rain water outlet. The rate also does not include hoisting and fixing in position, battens and beams. Painting of wooden beams & battens with preservative, is also not included.

9.2.16.2 Composite Rates

The unit rate shall include the cost of the materials specified above for carrying out the work in accordance with above specifications, in addition to the labour rate detailed in 9.2.16.1 above.

9.3 Second Class Tile Roofing

Second class tile roofing shall conform to the specification discussed in heading 9.2 above in all respects with the following exceptions: -

Only one layer of tiles shall be laid instead of two and their size shall be 12"x6"x2".

9.4 Jack Arch Roofing

9.4.1 Scope

Unless otherwise specified, Jack arch roofing shall be constructed according to the following Specifications.

9.4.2 Operation

Jack Arch roofing shall involve the following operations:

- (a) Construction of brick segmental arches in specified mortar.
- (b) Filling of haunches and crown with specified cement concrete.
- (c) Laying of bitumen blinded with sand over half an inch-thick bed of specified mortar.
- (d) Earth filling finished with mud plaster and gobi leeping.
- (e) Plastering soffits of arches.

9.4.3 Rise of Arch and Type

Unless otherwise specified, the arches shall be true segment of a circle and shall have a rise equal to 1/8th of the span.

9.4.4 Painting of Steel

Before fixing in position, R.S. beams and all other iron work shall be given specified coats of paint as detailed in the Specifications.

9.4.5 Laying of Tie Bars and Wall Plates

The end arch of series of Jack Arches springing from an unsupported outer wall shall be supported by an angle iron or a rail of specified section embodied in the wall immediately beyond the springing of the arch and shall be tied to the first joist by tie rods. Tie rods shall be perfectly straight and evenly spaced not more than 4 to 5 feet apart and shall be of ½ of an inch to 5/8 of an inch of diameter for span up to 6 feet, 3/4 of an inch diameter for span up to 7 feet and one inch to 1½ inches in diameter for spans more than 7 feet. In series of arches having more than 10 spans, intermediate tie rods shall be provided in every fifth span. Tie rods shall be put in at the specified place and nuts at the ends shall be tightened up correctly before centering are fixed.

9.4.6 Supporting of Centering

Centering shall be of sufficient stiffness to retain its curved shape without deflection. Its surface shall be correctly struck to the curvature of the soffit of the arch. The centering shall be supported on pillars built up from the ground or shall be suspended from the bottom flanges of the beams only if approved by the Engineer-in-charge. In the latter case, cross timber carrying the centering shall be suspended from the outer flanges of the beams by hook bolts of square section. No centering shall be attached nor shall the weight of centering come in any way on tie rods.

9.4.7 Precaution against Displacement

To prevent lateral displacement of the beams under the thrust of the arch at least 3 complete sets of centering shall always be used so that each arch under construction shall have two

preceding ones still supported till the whole roof is finished. Except in special circumstances in a wide roof where specified, all arches of one roof shall be started simultaneously from one side of the roof and the centering moved forward along the joists.

9.4.8 Building of Arch

Brickwork in arches shall conform to the Specifications for First Class Brickwork and for arch work the Specifications for Brickwork in Arches.

9.4.9 Spring Course

Bricks forming the spring courses shall be specially moulded so as to fit the joist and at the same time give a truly radiating skew back joint. In the absence of moulded bricks, the bricks shall be cut to the required shape, if approved by the Engineer-in-charge.

9.4.10 Key

Key shall be driven firmly into position with a wooden mallet and shall lie truly and centrally of a vertical line through the centre of the span.

9.4.11 Slope

Unless otherwise specified, the slope in the roof shall be given in R. S. beams while placing them in position.

9.4.12 Filling of Haunches and Crown

The haunches of the arch shall be filled and the arching covered with specified concrete thoroughly rammed and finished to a level so as to give a maximum thickness of 1½ inches over the crown, or the joists whichever is higher. The concrete shall be cured for ten days.

9.4.13 Bed for Bituminous Coating

After filling up haunches half an inch-thick cement sand plaster of specified ratio shall be laid over the surface to serve as a bed for bitumen.

9.4.13.1 Curing of Bed

The bed shall be cured for seven days and the surface shall be allowed to dry thoroughly before bitumen is laid.

9.4.13.2 Application of Bitumen Thickness

Bitumen shall be heated to a temperature specified by the manufacturer and poured on the surface to be treated and pulled out so that the minimum thickness is 1/16 of an inch. The coat of bitumen shall be continued along with the parapet wall up to the drip course.

9.4.13.3 Blinding of Bitumen Coating

The bitumen coat shall be blinded with sand at the rate of one cubic foot per 100 square feet of the surface area.

9.4.14 Earth filling and Mud Plaster

Three inches thick of good earth (clay) conforming to the specifications shall then be put and thoroughly rammed and watered. The roof shall then be finished with one-inch thick mud plaster with gobri leaping as per 9.2.10.

9.4.15 Plastering of Soffits

The soffits of the arches shall be plastered with specified mortar as per the specifications.

9.4.16 Plastering Bottom Flanges of Beams

In case where the lower (exposed) flange of the beam has to be covered with plaster, ½ inch mesh wire netting not lighter than 20 gauge shall be wound round it to let the plaster go under the flange. The netting shall be clipped on with hoop iron and shall be kept away from the flange by pieces of wood so as to afford a key to the plaster.

9.4.17 Measurement

Jack Arch roofing shall be measured by the superficial area of the roof. The unit of measurement shall be 100 square feet or square meter.

9.4.18 Rates

9.4.18.1 Labor Rates

- (a) Laying of bricks in segmental arches in specified mortar. Cutting of bricks, whenever required, curing and protecting as per above specifications and/or any other specifications specially included in the contract.
- (b) Filling of haunches and crown with specified concrete.
- (c) Laying of coat of hot bitumen blinded with sand over half an inch-thick bed of specified mortar.
- (d) Laying of 3 inches thick earth filling finished with mud plaster and gobri leaping.
- (e) Plastering of soffits of arches in specified mortar.
- (f) Providing, using and removing scaffolding, shuttering, centring, ladders, supports and use of any other tools and plants, required for carrying out the work as per above specifications

NOTE: The rate does not include hoisting, fixing in position and painting of R.S. beam, tie rods or another anchor. The rate also does not include the plastering of bottom flange of beams.

9.4.18.2 Composite Rates

The unit rate shall include the cost of all the materials specified above in carrying out the work in accordance with the above specifications, in addition to the labour rates detailed above.

9.5 Jack Arch Roofing (Sprung from Top of Beams)

Jack., Arch roof (sprung from the top of beams) shall conform to the Specifications of Jack Arch Roofing (sprung from the bottom of beams) in all respects, except the following: -

- a) **Extra Tie Bars Anchorage**

A second length of 3"x3"318" angle iron shall be provided. whenever. Tie rods are to be provided, to serve as an anchorage for the other ends of the tie rods which in this case cannot be anchored to the beams.

9.6 Jack Arch Roofing (For Carrying Flooring of the Rooms)

9.6.1 Description

Jack Arch roofing intended to carry the flooring of a room shall conform to the Specifications for Jack Arch roofing (sprung from either bottom or top of beams) in all respects, except the following: -

Operations referred in 9.4.2 (c), (d) and (e) of the Specifications shall not be performed.

9.6.2 Measurements

Roofing shall be measure by the superficial area of roof. The unit of measurement shall be square foot or square meter.

9.6.3 Rates

9.6.3.1 Labor Rates

The unit rate shall include:

- (a) Laying of bricks in segmental arches in specified mortar. Cutting of bricks, whenever required, curing and protecting as per above specifications and/or any other specifications specially included in the contract.
- (b) Filling of haunches and crown with specified concrete.
- (c) Plastering of soffits of arches in specified mortar.
- (d) Providing, using and removing scaffolding, shuttering, centring, ladders, supports and any other tools and plants, required for carrying out the work as per above Specifications.

NOTE: The rate does not include hoisting, fixing in position and painting of R.S. beam, tie rods or another anchor. The rate also does not include the plastering of bottom flange of beams.

9.6.3.2 Composite Rates

The unit rate shall include the cost of all the materials supplied at site of work, specified above in carrying out the work, in addition to the labour rates detailed above.

9.7 Flat Steel Sheet Roofing

9.7.1 Scope

Unless otherwise specified, plain flat steel sheet roofing shall be constructed in accordance with the following Specifications.

9.7.2 Materials

Unless otherwise specified, materials all conform to the following Specifications: -

- a) **Flat Steel Sheet** shall conform to the Specifications for Flat Steel Sheet.
- b) **Rolls** shall be made up of S.W.G. galvanized flat steel sheet conforming to the Specifications Flat Steel Sheets.
- c) **Fixing Accessories** shall be screws and clips and shall be approved quality and shall be invariably galvanized.
- d) **Roll Battens / Boarding** shall be wooden conforming to the Specifications to Timber of Book-1(Specification for Engineering Material).

9.7.3 Roofing Boarding

The sheeting shall be laid on boarding of wood of thickness specified. The boarding shall be but jointed unless specified otherwise with two screws (3-inch) holding each board to each rafter. Only that side of the boarding shall be wrought which is not covered by sheets.

9.7.4 Roll Battens

The roll battens shall be of specified wood, 2 inches by 1½ inch in section, with the top rounded to the curve of the ridge. They shall be fixed at the correct spacing, in parallel rows and secured to the boarding form underneath with 3-inch screws spaced not more than 2½ feet apart.

9.7.5 Preparing Sheets

The longitudinal edges of the sheets shall be curved to a radius of half an inch to that the rolled edge stands $\frac{3}{4}$ of an inch above the sheet. The top end of the upper most sheet shall be bent up 1½ inches.

9.7.6 Laying Sheets

The sheets shall be laid between the battens from the lower edge of the roof upwards. The lower edge of the first sheet shall be held to the planking by galvanized iron clips 6"x3/4"x1/8" at the two edges and then middle. The upper edge shall be kept under the lower edge of the next sheet which shall be held by an equal number of similar clips but 10 inches long. The 10-inch clips shall be fixed to the boarding by two screws at one end leaving the other end free for at least 6 inches to allow the lower sheet to be tucked underneath. The top most sheet, the upper edge of which has already been turned up, will butt against a batten 1½ "x 1" running between the roll battens and parallel to the ridge plate, and the turned-up portion shall be screwed to this batten.

The turned up longitudinal edges shall be kept down by 2" x 1" x ¼" galvanized iron pieces recessed into and screwed to the battens with 2-inch screws. Two such clips shall be used at the ends and two spaced equal in between.

9.7.7 Preparing and Fixing Rolls

Rolls shall be made from 5-inch wide strips bent to a radius of 1 inch and leaving 1 ½ - inch gap between the edges. They shall then be slipped down the roll battens so as to enclose the turned edges of the roofing sheets. Rolls shall be held at the lower end, in each case by a clip, 6"x3/4"x1/8" countersunk into the batten and screwed to it.

9.7.8 Ridge Sheeting

Unless otherwise specified, the ridge shall be made from 2 feet strips, one longitudinal edge of which shall be turned up 1½ inches to a radius of ½ inch. The ridge sheet shall be laid on longitudinal planking which shall be of wood and thickness specified, but jointed and unwrought on both sides. The ridge boarding shall be fixed on top of roll battens after the rolls have been fixed in place and shall be secured with 2-inch screws per board to each roll batten. The lower longitudinal edge of the ridge shall be secured by clips 6"x3/4"x1/8" screwed to the battens through the boarding, with 2-inch screws.

9.7.9 Ridge Roll

The ridge roll shall be made to a radius equal to the thickness of the ridge plate and with the edges separated by thickness of the beam, and slipped over the ridge sheets so as to enclose the turned-up edges.

9.7.10 Laps

Roof sheets and rolls shall not overlap to a length of less than 6 inches. Ridges, sheets and ridge roll shall not overlap to a length or less than 9 inches.

9.7.11 Wood Preservative

Unless otherwise specified, all boarding, battens and fillets shall be given two coats of hot creosote or other approved wood preservative.

9.7.12 Bending by Machine

A machine of approved type shall be used for tuning the edges of sheets and making all rolls. No hammering shall be allowed.

9.7.13 Hips, Valleys, Gutters and Flashings

Valleys, gutters and flashings shall be made in accordance with the Specifications for these items. Hips shall conform to paras 8 and 9 of these Specifications for ridges except that the end is stopped with a piece of galvanized iron sheet cut to fit. The junction between the ridges and hips shall be capped with milled lead sheeting weighing 5 lbs. per square foot. The lead sheet cap shall be carefully moulded to fit and shall have less than 9-inches overlap.

9.7.14 Measurements

The measurement of flat steel sheet roofing shall be done by the superficial area of the roof. The unit of rate shall be 100 square feet.

9.7.15 Rates

9.7.15.1 Labor Rates

The unite rate shall include: -

- a) Painting of roll battens with wood preservatives and laying them in position.
- b) Fixing of sheets and rolls in position with specified fixing accessories
- c) Labour for providing, using and removing all scaffolding, Shuttering, ladders and other tools and plants required for the satisfactory execution of work, in accordance with the above Specifications.

The boarding underneath the sheeting is not included in the rate. Also, the labour for ridges, hips and the boarding to which they are fixed and gutters and flashing are not included in the rate.

9.7.15.2 Composite Rates

The unite rate shall include the cost of (i) rolls batten (ii) flat steel sheets with all the specified overlapping and fixing accessories (iii) wood preservative paints required for carrying out the work as per above Specifications, in additions to the labour rate as detailed above.

9.8 Galvanized Corrugated Steel Sheet Roofing

9.8.1 Scope

Unless otherwise specified, galvanized steel sheet roofing (corrugated) shall be constructed in accordance with the following Specifications.

9.8.2 Materials

9.8.2.1 Galvanized Corrugated Steel Sheets

These shall conform to 9.8 of these specifications.

9.8.2.2 Fixing Accessories

Hook bolts, screws, bolts, nuts, rivets, washers shall be galvanized or shall be of any other approved quality.

9.8.2.3 Sealing Material

It shall be bituminous mastic.

9.8.2.4 Flashing Gutters

These shall conform to 9.12 "Gutters and Flashing" of these specifications.

9.8.3 Lap

- (a) End lap shall be minimum of 6 inches for slope and 4 inches for vertical falls which shall be sealed with specified sealing material.
- (b) Side lap shall be formed on the sides of the sheet, away from the prevailing direction of wind. The side lap shall vary from one to two corrugations as specified.

9.8.4 Insulating Material

Wherever specified, insulation material of specified quality shall be laid either between the purlins and the sheet or under purlins incorporating air gap.

9.8.5 Purlin Spacing

Purlin spacings for roof covering with G.C.S. sheets shall be arranged with a view to using standard sheets of uniform length throughout, and the trusses shall be designed for purlin spacings to suit the standard length of these sheets to avoid unnecessary cuttings. Ridge purlins shall be as near to the ridge as possible having regard to the type of ridge capping to be used and the manner in which it is to be fixed.

9.8.6 Hole

The holes for fixing bolts shall be made through crown of the corrugations and shall be either punched or drilled and shall be 1/16 of an inch larger in diameter than the bolts or fixing screws to be used. Holes shall be in the exact position to suit the purlins and no holes for fixing bolts shall be nearer than 1½ inches to the end of the sheet. These holes shall be made in a manner

that the arises of the punched hole shall come on top when the sheets are laid. Where 4 sheets overlap, holes shall be drilled and not punched.

9.8.7 Laying of Sheet

Before the laying of sheet begins it shall be seen that all purlins are in true plane correctly spaced and securely fixed. The purlins spacing and the length of sheet shall first be checked to see that the arrangement will provide the specified overhanging at the eaves and the laps. The eave course shall be laid first and work shall start at the leeward end of the building so that side laps have better protections from the rain driven by the prevailing wind. The top edges of eave sheet shall extend at least 1½ inch beyond the back of steel purlins or 3 inches beyond the centre line of a timber purlin.

9.8.8 Fixing Sheets

Sheets shall be fixed to steel purlins by hook bolts and to timber purlins by mushroom-headed galvanized drive screws. Hook bolts and drive screws shall be from 1/4 of an inch to 3/8 of an inch in diameter as specified and shall be spaced at an interval of not more than 15 inches. Sheets shall be secured at every purlin by at least 2 bolts. Nuts or heads of drive screws shall have specially made washers to render the holes waterproof. Washers shall be "Limpet" patent doom and shall be bedded on bituminous felt. Screws or bolts shall be tightened sufficiently to seat washers over the corrugation.

9.8.9 Ridges and Hips

- General accessories. Ridge or hip capping, wherever possible, shall be secured to the purlins by the same bolts or screws which secured the sheeting.
- Ridge cap shall be made up of galvanized flat steel conforming to the specifications or Flat Steel Sheet or otherwise specified. In case (a) above is not possible as the purlin is not sufficiently near the ridge, the capping shall be secured to the sheet by ¼ of an inch to 3/8 of an inch diameter bolts: two roofing bolts to each wing capping at centre not further apart than the bolts used for sheets. The lap of the capping along the ridge shall not be less than 6 inches and shall be so arranged as to protect the joints from the prevailing wind.
- Hip cap shall be cut to the required mitre and shall be close butted. The slope joints shall be covered with plain ridge cap which shall be secured through the roof sheet or the slope runner by one bolt on each side at the same spacing as for the roof sheets. Hip caps shall have a minimum lap of 6 inches.

9.8.10 Special Fastening Against Cables

For any situation exposed to strong winds, sheets shall be fastened down above the eaves by continuous length of 1½"x½" flat iron bars bolted down every 5 feet by ½-inch bolt built a foot into the wall and secured at the lower end by a 3-inch square washer.

9.8.11 Painting of Sheets

Wherever desired, sheets shall be painted with specified paint.

9.8.12 Measurements

The measurement of corrugated iron sheet roofing shall be done by the superficial area of the roofing. The unit rate shall be 100 square feet or square meter.

9.8.13 Rates

9.8.13.1 Labor Rate

The unit rate shall include:

- Hoisting and fixing of corrugated iron sheets in position with the specified fixing accessories.
- Punching or drilling holes and cutting of sheets.
- Providing, using, erecting and removing of scaffolding, benching ladders, templates and use of other tools and plants required for carrying out the work in accordance with the above specifications.

The labour for fixing purlins, gutters, flashing, ridges, specially fastening against cables etc., is not included. The labour for fixing insulating material is also not included.;

9.8.14.2 Composite Rate

The unite rate shall include the cost of (i) galvanized corrugated steel sheets with all the specified overlaps, (ii) MI bolts, nuts, hook bolts, wows and washers required for properly fixing sheets as per above Specifications, in addition to the labour rate detailed in 9.8.13.1 above.

9.9 Corrugated Asbestos Cement Sheet Roofing

9.9.1 Scope

Unless otherwise specified, corrugated asbestos cement sheet roofing shall be constructed in accordance with the following Specifications.

9.9.2 Materials

9.9.2.1 Corrugated Asbestos Cement Sheets

These shall conform to Book-1 (Specification for Engineering Material) Chapter-15 of these specifications.

9.9.2.2 Fixing Accessories

Hook bolts, nuts, and screws shall be galvanized or of any other approved quality. Washers shall be bituminous and galvanized iron or of any other approved type and quality.

9.9.2.3 Sealing Material

When specially required, sealing material shall consist of mastic of approved quality.

9.9.2.4 Flashing Gutters

These shall conform to 9.12 "Flashing and Gutters" of these specifications.

9.9.3 Lap

- (a) End lap shall be of a minimum size of 6 inches.
- (b) Side lap shall be formed on the sides of the sheet away from the prevailing wind. It shall be half the corrugation of sheets.

9.9.4 Overhanging

The minimum end overhanging in case of eave verges and cable ends shall be 12 inches. Overhanging verges shall be supported by purlins over the full width the sheet.

9.9.5 Purlin Spacings

Purlin spacings shall be arranged with a view to using standard sheets of uniform length throughout, and the trusses shall be designed for purlin spacings to suit the standard length of these sheets to avoid unnecessary cuttings. Ridge purlins shall be as near to the ridge as possible having regard to the type of ridge capping to be used and the manner in which it is to be fixed.

9.9.6 Holes

Holes in sheets shall always be drilled and shall on no account be punched. They shall be 1/16 of an inch larger in diameter than that of bolt or fixing screw, and shall be drilled through the crown of the corrugations. Holes shall be drilled in exact position to suit the purlins. No hole shall be made in valleys of corrugations and closer than 1½ inches from the edge.

9.9.7 Laying of Sheets

Before sheeting begins the structure shall be inspected to see that all purlins are in true plane, correctly spaced and securely fixed. Purlin spacings and the length of sheet shall be checked to see that the arrangement provides the specified laps and overhanging. The eave course shall be laid first, and work shall start at the leeward end of the building, so that the side laps shall have better protection from rain driven by the prevailing winds. The top edge of eave sheets shall extend 3 inches beyond the central line of purlins. Close fittings of sheets at the junction of side and end laps shall be ensured.

9.9.8 Fixing Sheets

G.I. bolts and screws required for fixing sheets shall be $\frac{1}{4}$ to $\frac{5}{16}$ of an inch in diameter. Nuts or heads of screws shall bear evenly on washers. Bolts or screws shall be fixed with G.I. washers over bituminous washers to fit tightly on the outer face of the sheet. Bolts or screws shall in the first operation be tightened lightly. They shall be tightened fully when about a dozen of sheets have been laid in position. For metal angle purlins the sheet shall be secured by bolts of 'J' or 'L' shape. For wooden purlins the sheet shall be fixed with gimlet pointed roofing screws which shall not be hammer-driven.

9.9.9 Ridges Cap

Capping shall be secured to the ridge purlins by the same bolts or screws which secured the sheeting; if ridge purlin is not sufficiently near the ridge to permit this each wing of the ridge, capping shall be secured to the sheeting by $1\frac{1}{2}$ "x $\frac{5}{16}$ " roofing bolts. Other asbestos cement accessories such as flashing etc. shall be secured either to the structure or by the roofing bolt of the sheeting.

9.9.10 Painting

When specially required, the Paint used for painting of sheets shall be of an approved quality.

9.9.11 Measurements

The A.C.C. sheet roofing shall be measured by the superficial area of the roof. The unit of measurement shall be 100 sq. feet

9.9.12 Rates

9.9.12.1 Labor Rate

The unit rate shall include:

- (a) Hoisting and fixing of A.C.C. sheets in position with specified fittings, i.e. nuts, screws, washers, hook bolts, bituminous washers etc.
- (b) Cutting of sheets and drilling of holes.
- (c) Providing, using and removing of scaffolding, benching ladders and use of other tools and plants required for carrying out the work in accordance with the above specifications.

9.9.12.2 Composite Rate

The unit rate shall include the cost of (i) A.C.C. sheets with all the specified overlaps, (ii) all bolts, nuts, screws, washers, etc., required for the proper fixing of sheets, in addition to the labour rate as detailed in 9.9.12.1.

9.10 Half Sawn Sleeper Roofing

9.10.1 Scope

Unless otherwise specified, half-sawn sleeper roofing's shall be governed by the Specifications stated below, and shall consist of the specified materials in accordance with the requirements set forth as under: -

9.10.2 Material

Unless otherwise specified, half-sawn sleeper roofing's shall consist of wooden bed blocks of specified sizes obtained from unserviceable sleeper, flat-footed unserviceable rail girders, one layer of half-sawn sleepers obtained from unserviceable sleepers, and 5-inch thick layer of mud and mud plasters.

9.10.3 Composition

Unless otherwise specified, half-sawn sleeper roofing's shall be constructed after the supporting walls have been raised to the specified height. Longitudinal wooden bed blocks shall be laid in the recess provided in the wall to the correct level and then specified rail girders from unserviceable rails shall be put across the supporting walls at specified spacings on these bed blocks. Half-sawn sleepers shall then be laid in the longitudinal direction of the walls butting against each other. Gaps between two such sleepers shall then be filled in with the specified mixture of sawdust and bitumen to make it watertight. Finally, a layer of 5 inches of mud and mud plaster shall be laid on the sawn sleepers and finished with a slope of 1 in 60 to drain out rain water efficiently. A water spout of approved type shall be also provided to the roof.

9.10.4 Ceiling

The exposed side of the sleeper shall be the sawn face, smoothed efficiently to allow easy painting. The joint between the sleepers shall be fine and in no case more than $\frac{1}{4}$ of an inch thick.

9.10.5 Painting

The exposed surface of the sawn sleepers and the rail girders shall be painted with specified paints. The rail girders shall be painted according to the 13.9 for Painting Iron Works of Book-2, and the sawn face of the sleeper shall be painted according to the 13.2 for painting Wood Works of Book-2 of these specifications.

9.10.6 Measurement

The measurement shall be taken of the superficial area of the roof. The unit of measurement shall be 100 square feet of the roof surface.

9.10.7 Rate

The unit rate shall include sawing of sleepers, making bed blocks, boisting rails in position, painting the sawn face of the sleeper and rails, making joints watertight, and providing a layer of 5-inch mud and mud plaster. Unserviceable sleepers shall be supplied by the Department. In case the sleepers are arranged by the contractor, the rate shall include the cost of the actual sawn sleepers laid in the roof, by cubical contents and paid for separately.

9.11 “Khurras” Parnalas” and Spouts

9.11.1 Khurras

9.11.1.1 Top Khurras

Unless otherwise specified, top khurras shall be 2 feet x 2 feet and shall be made of 1:2:4 cement concrete 1½-inch thick, laid on 1:4:8 cement concrete. The outside edge of the khurras shall be lower than the level of the mud plaster or leepai and the surface shall slope uniformly from that place to the outlet, which shall be 2 inches lower than the edges. Concrete shall have a slope 1:1 at the sides so as to be overlapped by earth and mud plaster. Cement concrete shall be continued into the outlet so as to ensure a watertight joint.

9.11.1.2 Bottom Khurras of Roof

Unless otherwise specified, bottom khurras on top of verandah or roofs shall be 2' x 2' and will consist of a 1½" layer of 1:2:4 cement concrete laid on 1:4:8 cement concrete. The surface shall be shaped like a saucer drain, the depth of the saucer being 2", and joining up with the roof drain, as described in 9.11.4.

9.11.1.3 Bottom Khurras on Ground

Unless otherwise specified, bottom khurras when used on the ground, in conjunction with spouts, shall be 4' x 2' and shall consist of bricks on edge in cement sand mortar 1:3 ratio laid on 3" of 1:4:8 cement concrete.

9.11.2 Parnalas

9.11.2.1 Revealed Parnalas

Unless otherwise specified, revealed parnalas shall be made by leaving a channel 7 inches wide and 2 ¼" inches deep in the wall during construction, and afterwards plastering the channel with 1:3 cement plaster. The corner of the channels shall be rounded to a radius of one inch in plastering. If revealed parnalas are left in a wall made of brickwork in mud, the bricks shall be laid in cement mortar (1:3) for a depth of 4 1/2 Inches from the back and sides of the parnalas, this work being included in the rate.

9.11.2.2 Khassi Parnalas

Unless otherwise specified, khassi parnalas shall consist of two fillets of cement plaster (1:3) raised 1½ inches and spaced 9 inches apart, the space in between being plastered with 1:3 cement sand plaster. The fillets shall be prismatic in section (but with all corners and angles rounded), the inner sides being at right angle to the wall and the outer sides sloping. Unless otherwise specified, khassi parnalas shall in no case be made on top of the cement or other plaster on the wall, but made in contact with the brickwork or masonry after raking out the joints.

9.11.3 Spouts

Unless otherwise specified, spouts shall be made of reinforced cement concrete and shall have an open channel 3¼"x3½" with a semi-circular bottom. These shall project at least 15 inches from the face of the wall and shall be built into the wall for a depth of at least 13½ inches. The part built into the wall shall be sufficiently thickened to provide adequate support for the overhanging portion. Spouts shall be fixed at a slope not flatter than 1 in 6 and shall have a lip at the lower edge to allow water to drip clear.

9.11.4 Roof Drains

Roof drains shall be provided on verandah and similar roofs to conduct water, discharged by the parnalas of a higher roof, to the outlet. They shall run in a straight line from the bottom khurra of one to the (top) khurra for the outlet concerned. Unless otherwise specified, the drain shall be saucer-shaped in section, the depth being 2 inches. Drains shall be made of 2 inches thick 1:2:4 cement concrete laid on cement concrete 1:4:8 of a section to give the necessary shape, with edges flush with the roof plaster.

9.11.5 Measurements

The parnalas and drains shall be measured along their length. The unit of measurement shall be per running foot. The khurras and spouts shall be measured as a jobs item. The unit of measurement shall be for a complete unit.

9.11.6 Rates

9.11.6.1 Labor Rate

The unit of rate shall include (i) all the labour required for the above operation and (ii) use of all the tools and plants required for carrying out work in accordance with the above specifications.

9.11.6.2 Composite Rate

The unit rate shall include the cost of all materials at site of work required for carrying out the work as per above specifications, in addition to the labour rate detailed in 9.11.6.1 above.

9.12 Gutters and Flashing

9.12.1 Description

This work covers providing and fixing gutters, flashings in accordance with these specifications.

9.12.2 Materials

Unless otherwise specified these shall be made from lead, copper, zinc or galvanized steel sheet:

9.12.2.1 Lead Sheets

Lead sheets shall be made from melted lead and shall not be less than the following weight per foot.

Gutters	6 lbs.
Flashings	5 lbs.

9.12.2.2 Copper Sheets

Copper sheets used for gutter shall be cold rolled and shall not be thinner than 22 S.W.G. For flashings it shall be dead soft temper and shall not be thinner than 24 S.W.G.

9.12.2.3 Zinc Sheets

Zinc sheets shall not be thinner than 20 S.W.G.

9.12.2.4 Galvanized Steel Sheets

Galvanized steel sheets shall be:

For gutters	No.18 S.W.G. to No.22 S.W.G.
For flashings	No.20 S.W.G. to No.24 S.W.G.

9.12.3 Gutters

Unless otherwise specified, gutters shall be semi-circular in shape, made of the material specified above and shall be properly finished and laid in specified shape. Gutters shall be supported with brackets fixed to wall or roofing at a specified distance apart.

9.12.4 Flashing

When the edge of a roof sheeting, or of a valley gutter is turned up against a wall, the edge shall be weather-proofed with a flashing. The flashing shall be inserted into the brickwork or masonry joints to a depth of 2 inches, the joints being filled up with 1:3 cement sand mortar unless otherwise specified. It shall be further secured in the joint by means of galvanized iron clips, in at least 4 inches into the masonry. The lower edge of the flashing shall overlap the sheeting below it by at least 4 inches, the edges of the sheeting and flashing being left free to expand and contract. Wherever flashing has to be laid at a slope, it shall be stepped at each course of the masonry, the steps being cut back at an angle of not less than 30 degrees to the vertical.

9.12.5 Measurements

Gutters

The measurement of gutters shall be along its length and the unit of measurement shall be per running foot or meter.

Flashing

The measurement of flashing shall be by the superficial area and its unit of measurement shall be per square foot or per square meter.

9.12.6 Rate

The rate for gutters and flashings is for completed work fixed in position, including all laps, supports and other fixing accessories.

9.13 Sleeper Roofing

9.13.1 Scope

Unless otherwise specified sleeper roofing's for temporary structures or unimportant buildings shall be constructed in accordance with following Specifications.

9.13.2 Composition

Unless otherwise specified sleeper roofing's shall be consisting of a layer of full or half-sawn sleepers with their sides butting against each other and joint fully caulked with a mixture of hot bitumen and sand. The top surface shall also be coated with the same mixture and then covered with layers of earth and mud plaster on the top. Wooden strips firmly nailed underneath the joints of the sleepers shall be provided.

9.13.3 Materials

- a) **Sleepers** – Sound unserviceable sleepers of a thickness of not less than 4” at the thinnest section in case of full sleepers, and 2” in case of half-sawn sleeper, shall be used.
- b) **Sand** – It shall conform to Chapter-6 of Book-1 (Specification for Engineering Material).
- c) **Bitumen** – It shall conform to chapter-12 of Book-1 (Specification for Engineering Material).
- d) **Clay** – It shall conform to Chapter-3 of Book-1 (Specification for Engineering Material).

9.13.4 Laying

The ends of the sleepers shall be cut square, the sides planed properly and holes, if any, shall filled with wooden plugs dipped in hot coal tar. The portions of the sleepers to be embedded in masonry work shall also be painted with hot coal tar. Each sleeper shall then be laid butting tightly against the adjacent one. These joints shall be provided with wooden strips measuring 2"x1/2" and firmly nailed on the underneath side of the sleepers. The joints shall be then caulked with a mixture of hot bitumen and sand, and a coating of the same mixture shall be given all over the roof surface. A layer of 4” of still clay of good earth kas specified shall be laid over the coating. In preparing the still clay care shall be taken that the earth at site dries in the sun and is then powdered and stacked in heaps of about 100 cft. Water shall then be added and the earth thoroughly mixed by treading with feet and brought into a consistency of stiff clay. This layer of earth shall be allowed to dry till there is no free moisture on the surface. The roof shall then be finished off with 1” thick mud plaster and leeped in accordance with the Specifications.

In case of sloping roofs, wooden battens shall be provided along the free ends and the front edge to support the earth. Eave boards shall also be provided if directed by the Engineer-in-charge. The ceiling of only half-sawn sleepers' roofing's shall be painted, if and as specified.

9.13.5 Spans

Both the half-sawn, and the full sleeper, roofing shall be used to cover spans from 4'-0” to 7'-6”.

9.13.6 Measurement

The unit of measurement shall be 100 square feet of the roof area.

9.13.7 Rate

The labour rate shall cover the sawing of sleepers in case of half-sawn sleeper roofing's, cutting ends, planning sides, plugging holes, laying on roof, caulking joints coating with bitumen and sand, providing 4" thick earth layer, and 1" mud plaster on top, and providing wooden strips underneath the joints. The battens and eave boards when provided shall be paid for separately as wood work.

9.14 Treatment of Roof Slab

9.14.1 Description

This work consists of treatment of pre-laid roof slab by application of bitumen, blinding of bituminous coating with sand, laying of polythene sheet, earth filling, mud plaster, laying of clay tile grouting of joints with cement sand mortar according to this specification.

9.14.2 Materials

9.14.2.1 Bitumen

It shall conform to Chapter-12 of Book-1 (Specification for Engineering Material).

9.14.2.2 Sand

It shall conform to Chapter-6 of Book-1 (Specification for Engineering Material).

9.14.2.3 Polythene

It shall conform to Chapter-15 of Book-1 (Specification for Engineering Material).

9.14.2.4 Earth

It shall conform to Chapter-3 of Book-1 (Specification for Engineering Material).

9.14.2.5 Clay Tiles

These shall conform to heading 4.2.2 of Chapter-4 of Book-1 (Specification for Engineering Material).

9.14.2.6 Mortar of Cement: Sand (1:3)

It shall conform to Chapter-5 of Book-2 of these specifications.

9.14.3 Construction Requirement

9.14.3.1 Surface Cleaning

The top surface of roof slab shall be scrubbed with steel wire brushes to remove / clean the loose particles of any material and dust.

9.14.3.2 Application of Bitumen

Bitumen shall be heated to a temperature specified by the manufacturers and shall be sprayed / painted at the rate of 34 lbs/100 sft. Precaution should be made that not patch/pin hole in the bitumen films created as a result of bitumen application.

9.14.3.3 Sand Blinding

The bitumen surface shall be blinded with sand at the rate of 1 cft/ 100 sft surface area.

9.14.3.4 Laying of Polythene Sheet

Polythene sheet of gauge 500mm (0.005") shall be laid on the bitumen blinded surface. Care should be taken to lay polythene sheet in such a way that overlaps allow flowing water to trickle down.

9.14.3.5 Earth Filling

4" average thick earth shall then be put and shall be thoroughly rammed and watered. For efficient run of the rain water, the earth should be laid in accordance with roof drainage profile.

9.14.3.6 Mud Plaster

Rammed earth surface shall be finished with 1" mud plaster to act as bedding for tiles.

9.14.3.7 Laying of Tiles

Clay Tiles 9" x 4½" x 1½" shall be laid on the mud plaster by keeping maximum joint between the two tiles not more than ¼".

9.14.3.8 Cement Sand Grouting

The joints between the tiles shall be grouted with cement-sand mortar/slurry. It should be ensured that there shall be no slurry remained deposited on the flat surface of tiles.

9.14.4 Measurement

The measurement of roof treatment shall be measured by the superficial its unit shall be 100 Sft or Sq. Meter.

9.14.5 Rate

9.14.5.1 Labor Rate

The rate shall include: -

- a) Cleaning of the surface of the pre-laid R.C. slab.
- b) Heating and spraying of bitumen.
- c) Sand blinding.
- d) Laying of polythene sheet.
- e) Lifting and laying earth on roof including watering and ramming.
- f) Laying of bedding of mud mortar.
- g) Laying of tiles.
- h) Grouting of joint with cement sand mortar
- i) Cost for providing T&P required for carrying out work in accordance with above specification.

9.14.5.2 Composite Rate

The rate shall include the cost of materials supplied at site as specified in 9.14.5.1 to the labour.

9.14.6 Bituminous Membrane Water Proofing Method

9.14.6.1 General

A bituminous waterproofing membrane should be used for reinforced concrete roof waterproofing. This waterproofing membrane shall come on site in the form of rolls manufactures and packed in the factory properly sealed.

9.14.6.2 Material Requirements

- The specifications and safety manuals of this membranes provided by manufacturer should be read before installation process. Fire safety and prevention shall the most important while using this membrane.
- All inflammable materials from roofs to be removed and good roofing practices should be followed.

9.14.6.3 Laying Procedure

- The bituminous waterproofing membranes should unfold on the site and laid firmly on surface with tar-based adhesives using blowtorches.
- A layer of bituminous water proof membrane shall be laid over the structural roof which shall acts as a shield against the seepage of water onto the roof. Roof tiles & membrane applied over the filler material laid to slope to pass the flow of water into drains. A proper slope is necessary to allow the water to flow steadily to drains.
- These membranes should have 2 to 4 mm thick water proof materials. Membrane should be flexible with elongation 150 % to cover any small cracks, strong, chemical & UV resistant, flexible enough to take any shape over which it is laid.

9.14.6.4 Precaution during use

- The surface to be membrane should be clear from dirt, dry and clean. Must not be installed during adverse weather and below 450 F. For slope up to 3 inch the membrane should be laid perpendicular to slab and more than 3-inch slope should be laid parallel to slope. This ensures that water is never be running at joint lap edge.
- Torch equipment's should be properly connected and hoses to be in good working condition. Check the equipment against gas leakage by using soapy water. When torch is opened it should be at lowest possible settings to avoid sudden gush of fire.
- No wrinkles should be allowed while laying membrane and proper alignment is necessary.
- While torching membrane on joints, approximately 1-inch chemical from the waterproofing membrane should be flowing out to ensure proper filling of gaps. More than 1-inch flow out signals to overheating of membrane.
- Roller should be laid over joints along with torching so that compound sets properly and no gap is created in joints.
- There should be no air gap between two sheets to ensure proper adhesion of end laps of membrane. At gaps the sheets should be lifted and heated with the torch and resealed again.
- At the end of sheet should be heated properly as to bitumen starts appearing over the sheet. Heat the underside of membrane properly to ensure proper bond at laps.
- The bituminous waterproofing membrane sheets should overlap 3 inches at the sides and 6 inches at the ends for proper grip and waterproof joint and block water seepage. Staggered end laps must be 18 inches apart so that no adjacent end laps coincide
- Granules applications matching the sheet at the end laps and roller should spread to set it properly.

9.15 Thermal Insulation of R.C.C Roof

9.15.1 Description

This work shall consist of thermal insulation of pre-laid RCC roof slab by application of bituminous coating with sand blinding, laying of polythene sheet, laying thermophore sheet, laying of 3" (average) earth filling 1" mud plaster, laying of clay tiles 9" x 4½" x 1½" grouting of joints with cement sand mortar according to this specification.

9.15.2 Materials

9.15.2.1 Bitumen

It shall conform to Chapter-12 of Book-1(Specification for Engineering Material).

9.15.2.2 Sand

It shall conform to Chapter-6 of Book-1(Specification for Engineering Material).

9.15.2.3 Polythene Sheet

It shall conform to Chapter-15 of Book-1(Specification for Engineering Material).

9.15.2.4 Earth

It shall conform to Chapter-3 of Book-1(Specification for Engineering Material).

9.15.2.5 Clay Tiles 9" X 4½" X 1½"

These shall conform to Chapter-3 of Book-1(Specification for Engineering Material).

9.15.2.6 Mortar Cement Sand 1:3.

It shall conform to Chapter-5 of these specifications.

9.15.3 Composition of Thermal Insulation of Roof

- a) Bitumen painting two coats at the rate of 34 Lbs./100 sft for both coats.
- b) Polythene sheet of 250 mm Micron.
- c) Thermopore sheet of density not less than 30 kg/m³ and having thickness not less than 1".
- d) Polythene sheet 500 Micron followed by
- e) 4" (A.V) earth cushion very lightly rammed after sprinkling of water followed by.
- f) 1" mud plaster for bedding of tile followed by.
- g) Clay tile 10" x 5" x 1.5" laid with open joint not more than ¼" followed by.
- h) Grouting of tile joints with 1:3 cement sand mortar slurry.

9.15.4 Construction Requirement

9.15.4.1 Surface Operation

It shall be in accordance with the 9.14.3.1 of these specifications.

9.15.4.2 Application of Bitumen

1. Scope

Where specified a bitumen coat shall be applied on roof as specified and approved by the Engineer-in-Charge. Unless otherwise approved by the Engineer-in-Charge, the bitumen shall conform to ASTM Designation D-449-89.

2. Preparing the Surface

The surface shall be painted only when it is fully dry. The surface to be painted shall be cleaned with wire brushes and cotton or gunny cloth. All loose materials and scales shall be removed and the surface shall be further cleaned with a piece of cloth lightly soaked in kerosene oil.

3. Painting with Bitumen

The contractor shall bring the bitumen to site in its original packing and shall open and use it in the presence of the Engineer-in-Charge or his authorized representative. The containers shall not be removed from the site until the painting job is completed and the Engineer-in-Charge has satisfied himself regarding the quantity of bitumen actually used and has given his permission to remove the empty containers.

The surface prepared and treated shall be painted uniformly with bitumen of approved quality such as residual type petroleum bitumen of penetration 80/100, hot cut back bitumen or equivalent as per specifications of the manufacturer. The coat of bitumen shall be continued 15 cm along the vertical surfaces joining the roof. In case of parapet walls, it shall be continued up to the drip courses. Residual type petroleum bitumen of penetration 80/100 shall be heated to a temperature of not less than 180-degree C and not more than 190-degree C and shall be applied on the roof surface at not less than 180-degree C. Similarly, hot cut back bitumen shall be heated to a temperature of not less than 165 degree C and not more than 170-degree C and shall be applied on the surface at not less than 165degree C.

Care shall be taken to see that no blank patches are left. The quantity of bitumen to be applied per 10 square meters of roof surface shall be 17 kg, unless otherwise stipulated in the description of the item. It shall be carefully regulated so that the application is uniform at the stipulated rate of 17 Kg. per 10 square meters.

4. Spreading Sand

Immediately after painting, dry, clean sharp coarse sand at the rate of 60 cubic decimeter per 10 Sq.m. shall be evenly spread and levelled over the surface when the bitumen is still hot.

9.15.4.3 Sand Blinding

It shall be in accordance with the 9.14.3.3 of these specifications.

9.15.4.4 Laying of Polythene

It shall be in accordance with the 9.14.3.4 of these specifications.

9.15.4.5 Laying of Thermopore Sheet

On pre-laid film of polythene thermopore sheet of specified thickness shall be laid. Care shall be taken not to allow workmen, to work directly on the thermopore sheets.

9.15.4.6 Laying of Polythene

Polythene sheet of 500 Micron shall be laid over the thermopore sheet in accordance with 9.14.3.4 of these specifications.

9.15.4.7 Earth Cushion

3" thick earth cushion lightly rammed fully damped properly leveled in accordance to the roof drainage profile shall be laid.

9.15.4.8 In all other Respects

It shall conform to 9.14 "Treatment of Roof Slab" of these specifications.

9.15.5 Measurement

The measurement of the treated area shall be surface area its unit shall be 100 sft.

9.15.6 Rate

9.15.6.1 Labor Rate

The rate shall include: -

- a) Cleaning of the surface of the pre-laid R.C.C slab.
- b) Heating and spraying of bitumen.
- c) Sand blinding
- d) Laying of polythene sheet.
- e) Laying of thermophore sheet.
- f) Laying of polythene sheet 500 Micron
- g) Lifting and laying earth on roof including watering and ramping laying of bedding of mud mortar.
- h) Laying of bedding of mud mortar.
- i) Laying of tiles.
- j) Grouting of joint with cement sand mortar.
- k) Cost for providing T&P required for carrying of work in accordance with above specification.

9.15.6.2 Composite Rate

The rate shall include the cost of materials supplied at site as specified in 9.15.6.1.

9.15.7 Spray Foam Insulation (Sprayed Polyurethane Roof Treatment)

9.15.7.1 General

The roof waterproofing system shall be as follows: -

- Layer 1: Sprayed foam of polyurethane complying with BS 5241-part 1 applied to provide a maximum thermal transmittance value of $0.60 \text{ W/m}^2 \cdot ^\circ\text{C}$ and with a thickness not less than 35 mm.
- Layer 2: Liquid protective membrane applied to a minimum dry film thickness of 800 microns.
- Layer 3: A protection layer of 100 grams per square meter (g/sm) of geotextile.

- Layer 4: Grade 20 concrete protective screed applied to slope with a minimum thickness of 50 mm and slope not less than 1:80

9.15.7.2 Material Requirements

1. Polyurethane Foam

The polyurethane foam shall be sprayed to a minimum thickness of 35 mm. The basic component of the polyurethane foam shall be polyol resin and isocyanate liquid which are pumped under pressure in metered amounts. The blowing agent in the polyol resin shall be environmentally friendly, meeting the requirements of environmental local authorities. During spraying operation, the temperatures, pressures, and volumes of mixing shall be properly controlled as per manufacture's recommendation to achieve the required physical properties listed in table below.

Physical Property	Test Result	Test Method
Min Core Density	36 Kg/m ²	
Min Compressive Strength	2.0 Kg/cm ²	Method 3 of BS 4370 Part 1
Max Thermal Conductivity (initial Value)	0.018 W/mk	Method 7 of BS 4370 Part 2
Max Water Absorption (by volume)	6.5 %	Appendix B of BS 5241 Part 1
Min Closed Cell Content (by volume)	90%	Method 10 of BS 4370 Part 2

Table 2, Physical Properties of Foam (Chapter 9)

The containers for the raw materials of the sprayed PU foam shall have the manufacturer's name, product identification and shelf life clearly printed. The waterproofing system materials quality shall be checked on a regular basis. Initially test specimens should be taken from every 100 m². Once satisfactory standard has been established the area per test shall be increased to 500 m².

2. Protective Waterproofing Coating

The protective waterproofing coating shall be cold liquid applied to form a seamless membrane. The coating shall be a one component moisture curing based on polyurethane elastomer. The finished surface shall provide an elastomeric, flexible membrane that is free from pin- holes, blisters and any other defect. All coating components shall be compatible with the foam to avoid any chemical reaction. The finished membrane shall have a minimum elongation of 300% and a recovery of 90%. The minimum dry film thickness shall not be less than 800 microns.

3. Geotextile Sheet

A layer of 100 gsm of non-woven needle punched geotextile sheet. The sheet shall be made from continuous thermally bonded polypropylene filaments.

4. Protective Screed

The screed concrete shall be complied to the requirements given below: -

The structural lightweight concrete shall be of specified grade but for thermal insulation the concrete shall be low strength foam concrete and density as specified. Cement sand mortar in 1:2 ratio and admixture of foaming chemicals as approved by the Engineer-in-Charge shall be used. The amount of different ingredients needed to develop a certain density shall be according to the recommendations of the manufacturer for foaming agent and shall be determined by trial mixes under instructions of the Engineer-in-Charge. All materials and the producing, forming, placing, curing and repairing of the foam concrete shall be in accordance with the applicable requirements of Plain and Reinforced Concrete.

Joints and expansion joints in the screed shall be treated with approved sealant.

5. Coating for Exposed Areas

Whenever coating is required to be used in exposed areas, the coating shall be especially formulated to resist the effect of sun light and provide waterproofing properties. The coating applied shall be cold liquid applied and shall form a seamless membrane after application. The coating shall be based on polyurethane and the ultimate elongation of the finished product shall not be less than 120%.

9.15.7.3 Construction Requirement

1. Surface Preparation

Before application of foam the roof slab shall be dry and cleaned to remove loose particles, dust, laitance, efflorescence, etc. Surfaces must be approved by the Engineer prior to application including fillet application. No other activity shall be permitted on the roof during the application of polyurethane foam. The end levels of application shall be marked from datum.

2. Polyurethane Foam Application

Spraying shall be carried out when the weather is within the following conditions unless approved by the Engineer-in-Charge: -

- Wind speed is not excessive to disrupt the spraying operation and cause damages to the adjacent properties.
- Relative humidity is not in excess of 90%
- Temperature within the manufacturer allowable limits
- No rain or imminent rain condition.

The foam shall be applied in layers as recommended by the supplier such that the total specified minimum thickness is built up in layers and the cells of the PU foam are vertical. The first coat or layer (Flash coat) shall be thinner than the subsequent layers. The time required between one layer and the other shall not be less than 2 minutes and not greater than 15 minutes. The finished surface shall be even and smooth without pinholes, discontinuities or undulations.

3. Protective Membrane Application

The liquid protective membrane shall be applied in accordance with the manufacturer's recommendations. The membrane shall be applied to the PU foam as soon as possible but

not before the foam is completely dry (follow manufacturers specifications). Particular attention shall be given to locations where it is likely to have failures such as water spouts, up stands, edges, etc. The finished surface of the membrane shall be free from pin holes and it shall not have any uncurled areas or any other observable defects.

4. Geotextile Sheet Layer

The Geotextile sheet shall be placed directly over the coating when the coating is dry. The sheet shall be placed after conducting the flood test. Adequate time shall be given for the coating to cure as recommended by the manufacturer. Overlaps in the geotextile sheet shall be at least 200mm and all joints shall be sealed by the approved waterproof coating.

5. Roof Screed

Screed shall be laid to the thickness and falls shown on the approved detailed drawings to a minimum thickness of 50mm and shall be kept wet and protected and cured as per direction of Engineer-in-Charge. Care shall be taken to ensure that screeds are level at abutments with walls etc. The screed shall be constructed to a slope not less than 1:80 and finished evenly.

9.15.7.4 Precautionary Measures during Installation

These steps should be followed where Spray polyurethane foam is being applied to control the exposure.

- Review label and product information for ingredients, hazards, directions, safe work practices, and precautions.
- Ensure health and safety training is completed and safe work practices are followed to prevent eye, skin, and inhalation exposures during and after SPF installation.
- Exercise caution when determining safe re-occupancy for unprotected occupants and workers based on the manufacturer's recommendation.
- Only applicators and helpers using effective workplace practices (including ventilation), appropriate personal protective equipment, and other steps to control exposures should be present during and for a period of time after SPF installation. To avoid chemical exposures as these products cure, the occupants of the home/building, as well as workers from other trades, should not enter the site until the spray foam manufacturer's "re-occupancy" procedures have been satisfied.

9.15.7.5 Measurement and Payment

- Length and breadth of the roofing insulation shall be measured correct to a cm and the surface area worked out in square meter of the finished work.
- No deduction shall be made for openings of areas up to 40 square decimeters.
- No extra payment will be made for any extra material or labour involved in forming such openings.
- For openings exceeding 40 square decimeters in area, deduction for the full opening will be made, but nothing extra will be paid for any extra material or labour involved in forming such openings.

9.15.8 Extruded Polystyrene Board Roof Treatment System

9.15.8.1 General

The roof treatment system is conducted by using two method

1. Method-I

- Layer 1: Application of water proofing layer, laying of bitumen coating at the rate of 34 lbs./100ft²(1.7 kg/m²) of surface area or 1/16" thick is given for making the roofs water proof or by the application of water proofing chemical as per drawings or direction of Engineer-in- Charge.
- Layer 2: Laying of polystyrene board of approved thickness.
- Layer 3: Laying of polythene sheet of specified gauge as mentioned on drawings or as per direction of Engineer-in-Charge.
- Layer 4: Provision of mud layer of the thickness given in drawings.
- Layer 5: Cement mortar of 1-inch thickness.
- Layer 6: Laying of roof tiles.

2. Method-II

- Layer 1: Application of water proofing layer, laying of bitumen coating at the rate of 34 lbs./100ft²(1.7 kg/m²) of surface area or 1/16" thick is given for making the roofs water proof or by the application of water proofing chemical as per drawings or direction of Engineer-in- Charge.
- Layer 2: Laying of polystyrene board of approved thickness.
- Layer 3: Laying of polythene sheet of specified gauge as mentioned on drawings or as per direction of Engineer-in-Charge.
- Layer 4: Application of foam concrete.
- Layer 5: Laying of roof tiles.

9.15.8.2 Materials

1. Extruded Polystyrene Board

The polystyrene board XPS board is provided as discussed above in 25,38,50,75 mm (1", 1.5", 2", 3") respectively thicknesses. This is board have highly water resistant, lower values of thermal conductivity, high resistant to freeze and thaw cycle, non-toxic, light weight, long life available in sizes of (L x W) 6ft x 3ft, 8ft x 3ft, 6ft x 2ft, 8ft x 2ft. The edges profiles of the sheets for joining may be of butt joint, ship lap and Tong and groove type. To achieve the best quality the board should fulfil the following requirements as given in the table given below.

9.15.8.3 Measurement

Length and breadth of the roofing insulation shall be measured correct to a cm and the surface area worked out in square meter of the finished work. No deduction shall be made for openings of areas up to 40 square decimeters. No extra payment will be made for any extra material or labour involved in forming such openings. For openings exceeding 40 square decimeters in area deduction for the full opening will be made, but nothing extra will be paid for any extra material/labour involved in forming such openings. Board fixed to curved surfaces in narrow widths shall be measured and paid for separately. Circular cutting and waste shall be measured and paid for separately in running meters.

Sr. No	Item	Unit	Result	Testing Method
1	Colour	----	Pink, Green, Blue	
2	Cell Structure	----	Closed very fine	
3	Density (min)	Kg/m ³	32~38 ± 10%	BS 4370 Method 2
4	Thermal Conductivity.	BTU in/ft ² .hr. °F W/mk	0.199 0.026	ASTM C-518 KS M 3808-05
5	Compressive Strength	KPa	250~400	ASTM D 1621
6	Coefficient of linear thermal expansion	mm/mk	0.07	BS 4370 Method 13
7	Temperature Limits	°C	-50/ +75	----
8	Fire classification	----	A	BS 3837 Part 1 1986

Table 3, Requirements for Extruded Polystyrene Board (Chapter 9)

9.16 Plastic Roofing (Fiber Glass Roofing)

9.16.1 Scope

The scope of work includes of supply of all materials and construction of plastic (Fiber Glass) roofing complete as shown on drawings in accordance with the specifications and as approved by the Engineer-in-Charge.

9.16.2 Materials

- The preformed plastic panels or corrugated translucent sheets made from thermosetting polyester resins to comply with BS 4154 and are to match with the profile of the roofing as specified and shown on drawings. The thickness and colour of plastic panels shall be as designated in drawings. The sheets shall be procured from an approved source.
- The fixing accessories shall consist of G.I. bolts nut, limpets and washers for installation and jointing of sheets.
- Roll battens/boards shall be wooden, Aluminium and mild steel sections as shown on drawings. The wooden battens and section shall according to the requirements of Woodwork.

The steel sections shall be made of galvanized steel sections conforming ASTM A-36. The Aluminium sections shall be conforming BS EN 573-3:2013.

9.16.3 Roof Construction

The fiber glass sheets shall be laid on the previously installed boarding frame and firmly secured with the holding accessories as given below.

1. Roofing Boarding

The sheeting shall be laid on boarding of wood of thickness specified. The boarding shall be butt jointed unless specified otherwise with two screws (3") holding each board to each rafter. Only that side of the boarding shall be wrought which is not covered by sheets.

2. Roll Battens

The roll battens shall be of specified wood, 2" by 1-1/2" in section, with the top rounded to the curve of the ridge. They shall be fixed at the correct spacing, in parallel rows and secured to the boarding from underneath with 3" screws spaced not more than 2-1/2 feet apart.

3. Preparing Sheets

The longitudinal edges of the sheets shall be curved to a radius of half an inch to that the rolled edge stands $\frac{3}{4}$ of an inch above the sheet. The top end of the upper most sheet shall be bent up 1-1/2".

3. Laying Sheets

The sheet shall be laid between the battens from the lower edge of the roof upwards. The lower edge of the first sheet shall be held to the planking by galvanized iron clips 6"x3/4"x1/8"

at the two edges and then middle. The upper edge shall be kept under the lower edge of the next sheet which shall be held by an equal number of similar clips but 8" long. The 8" clips shall be fixed to the boarding by two screws at one end leaving the other end free for at least 6" to allow the lower sheet to be tucked underneath. The top most sheet, the upper edge of which has already been turned up, will butt against a batten 1-1/2"x1" running between the roll battens and parallel to the ridge plate and the turned-up portion shall be screwed to this batten. The turned up longitudinal edges shall be kept down by 2"x1"x1/4" galvanized iron pieces recessed into and screwed to the battens with 2" screws. Two such clips shall be used at the ends and two spaced equally in between.

4. Preparing and Fixing Rolls

Rolls shall be made from 5" wide strips bent to a radius of 1" and leaving 1-1/2" gap between the edges. They shall then be slipped down the roll battens so as to enclose the turned edges of the roofing sheets. Rolls shall be held at the lower end, in each case by a clip, 6"x3/4"x1/8" countersunk into the batten and screwed to it.

Roof sheets and rolls shall not overlap to a length of less than 6". Ridges, sheets and ridge roll shall not overlap to a length of less than 9". The over laps and ridges shall be provided in accordance given below.

5. Ridge Sheeting

Unless otherwise specified, the ridge shall be made from 2 feet strips, one longitudinal edge of which shall be turned up 1-1/2" to a radius of 1/2". The ridge sheet shall be laid on longitudinal planking which shall be of wood and thickness specified, butt jointed and unwrought both sides. The ridge boarding shall be fixed on top of roll battens after the rolls have been fixed in place and shall be secured with 2" screws per board to each roll batten. The lower longitudinal edge of the ridge shall be secured by clips 6"x3/4"x1/8" screwed to the battens through the boarding, with 2" screws.

6. Ridge Roll (Wooden)

The ridge roll shall be made to a radius equal to the thickness of the ridge plate and with the edges separated by thickness of the beam and slipped over the ridge sheets so as to enclose the turned-up edges.

9.16.4 Measurement

- Length and breadth shall be measured correct to a cm and its area shall be calculated in square meters correct to two places of decimal.
- The superficial area of roof coverings shall be measured on the flat without allowance for laps and corrugations. Portions of roof covering overlapping the ridge or hips etc. shall be included in the measurements of the roof.
- Roof with curved sheets shall be measured and paid for separately. Measurements shall be taken on the flat and not girthed. The breadth of the roof shall be measured along the rest of the curved sheets.
- No deductions in measurements shall be made for opening up to 0.4 sqm and nothing extra shall be allowed for forming such opening. For any opening exceeding 0.4 sqm in area, deduction in measurements for the full opening shall be made and, in such cases, the labour involved in making these openings shall be paid for separately. Cutting across corrugation shall be measured on the flat and not girthed.

- The rate shall include the cost of all the materials and labour involved in all the operations described above except otherwise stated. This includes the cost of roof sheets, polymer coated or L hook, bolts and nuts, bituminous and galvanized iron washers.

9.17 Cast Iron Pipes for Rain Water

9.17.1 Cast Iron Pipes & Filling

Cast Iron pipes and fillings shall conform to BS 78 for spigot and socket vertically cast pipes and BS 1211 for spigot and spun pipes. The pipes shall be perfectly, smooth and cylindrical, their inner and outer surfaces being as nearly as practicable concentric. These shall be sound and of uniform castings, free from laps, pin holes or other imperfections and shall be neatly finished and carefully fitted both inside and outside. The ends of pipes shall be reasonably square to their axes. The pipes shall be procured from an approved source.

9.17.2 Dimensions

C.I. rain water pipes shall be of the dia. specified in the description of the item and shall be in full length of 1.8 meter including socket ends of the pipes, unless shorter lengths are required at junctions with fittings. The pipe lengths shall be in each case be with socket. The pipes shall be supplied without ears unless otherwise specifically mentioned. The pipes supplied shall be factory painted (with a tar base composition) both inside and outside which shall be smooth and tenacious. Every pipe shall ring clearly when struck all over with a light hand hammer. When shorter pipes are cut from full lengths they shall be cut with a hacksaw. The sizes, weights, sockets and tolerances of pipes shall be as shown in Table- Dimensions and Weight of C.I. Rain Water Pipes.

	Nominal Size of pipes (internal diameter in mm)	50	75	100	125	150
1	Pipe					
a)	External diameter in mm	53	79	104	130	156
	Tolerance in mm	± 3	± 3	± 3.5	± 3.5	± 4
b)	Thickness in mm	3	3	3	3	4
	Tolerance in mm	± 1	± 1	± 1	± 1	± 1
	Nominal size of pipes (Internal dia. in mm)	50	75	100	125	150
c)	Nominal weight of 1800 mm long pipe without ears in kg	7.50	11	14	20	26
	Tolerance in weight	(-) 10%	(-) 10%	(-) 10%	(-) 10%	(-) 10%
	Tolerance in length in mm	± 13	± 13	± 13	± 13	± 13
2	socket					
a)	Internal diameter in mm	63	89	114	139	167
	Tolerance in mm	± 13	± 13	± 13	± 13	± 13
b)	Thickness in mm	4	4	4	4	4
	Tolerance in mm	± 1	± 1	± 1	± 1	± 1
c)	Internal depth in mm	60	65	65	75	75
	Tolerance in mm	± 10	± 10	± 10	± 10	± 10

Table 4, Dimensions and Weight of C.I. Rain Water Pipes (Chapter 9)

Note:

- All dimensions are in mm.
- Pipes weighing more than the nominal weight may be accepted provided they comply in every other respect with the requirements of the standard.

- The above table applies only to rain water pipes fixed on wall face.
- For pipes and fittings which are to be embedded in masonry, specifications shall correspond with those of pipes for soil, waste, and vent pipes.

9.17.3 Fixing and Jointing

- Pipes shall be either fixed on face of wall or embedded in masonry, as required in the description of the item.
- Plain pipes (without ears) shall be secured to the walls at all joints with M.S. holder bat clamps. The clamps shall be made from 1.6 mm thick galvanized M.S. sheet of 30 mm width, bent to the required shape and size so as to fit tightly on the socket of the pipe, when tightened with screw bolts. It shall be formed out of two semi-circular pieces, hinged with 6 mm dia M.S. bolt on one side and provided with flanged ends on the other side with hole to fit by the screw bolt and nut, 40 mm long. The clamp shall be provided with a hook made out of 27.5 cm long 10 mm diameter M.S. bar, riveted to the ring at the centre of one semicircular piece. The clamps shall be fixed to the wall by embedding their hooks in cement. concrete block 10 x 10 x 10 cm in 1:2:4 mix (1 cement: 2 coarse sand: 4 graded stone aggregate 20 mm nominal size) for which necessary holes shall be made in the wall at proper places. The clamps shall be kept about 25 mm clear off finished face of wall, so as to facilitate cleaning and painting of pipes.

Note:

- Where G.I. sheet clamps are not provided, M.S. sheet clamps of 3 mm thick and 20 mm wide shall be used for making the clamps.
- The pipes shall be fixed perfectly vertical or to the lines as directed. The spigot of the upper pipe shall be properly fitted in the socket of the lower pipe such that there is a uniform annular space for filling with the jointing material. The annular space between the socket and the spigot shall be filled with a few turns of cotton spun yarn soaked in neat cement slurry. These shall be pressed home by means of caulking tool. More skins of yarn shall be wrapped if necessary and shall be rammed home. The joint shall then be filled with stiff cement mortar 1:2 (1 cement: 2 fine sand) well pressed with caulking tool and finished smooth at top at an angle of 45 degree sloping up. The joints shall be kept wet for not less than 7 days by tying a piece of gunny bag, four-fold, to the pipe and keeping it moist constantly.
- Where pipes are to be embedded in masonry, these shall be fixed in masonry work as it proceeds. In such cases care shall be taken to keep the pipes absolutely vertical or to the line as directed by the Engineer-in-Charge. The pipe shall have a surrounding of 12 mm minimum thickness of mortar at every portion of the external surface. The mortar shall be of the same mix as is used in the masonry. The joint shall be caulked with lead as soon as the next length of pipe is placed in position. The open end (socket end) of the pipe shall be kept closed till the next length is fitted and jointed, to prevent any brick bats or concrete or pieces of wood falling in and choking the pipe. The depth of lead from the lip of socket shall be 25 mm minimum. In case of 100 mm dia. 75 mm and 50 mm pipes, the quantity of lead required per joint shall be 1.00 kg, 0.66 kg and 0.50 kg respectively for purpose of reckoning theoretical Consumption. In order to ensure that required quantity of lead is poured into the joint and to control wastage of lead, at the beginning, three or four samples shall be made and the quantum of lead per joint approved by the Engineer-in-Charge. The actual consumption of lead should be within $\pm 5\%$ of the approved sample job subject to the provision that a variation of

± 20% shall be allowed over the theoretical quantity of lead due to dimensional tolerances. This variation includes allowances of wastage also.

- The spigot end shall butt the shoulder of the socket and leave no gap in between. The annular space between the socket and the spigot will be first well packed in with spun yarn leaving 25 mm from the lip of the socket for the lead. The joint shall then be fully lead caulked approved by the Engineer-in-Charge.

9.17.4 Measurements

The rate shall include in the case of fittings fixed on the face of wall, the cost of all materials and labour involved in all the operations described above including jointing including the supply and fixing the M.S. holder bat clamps in walls and the anchoring concrete. Unless otherwise specified in the description of the item, the rate shall apply for fittings without access doors. In the case of fittings forming part of a rain water pipe line embedded in masonry, the rate shall be for supplying and embedding the fittings in masonry.

9.17.5 Cast Iron Accessories for Rain Water Pipes

9.17.5.1 C.I. Fittings

C.I. accessories such as bends of various degrees, heads, offsets of different projections, branches and shoes shall be of approved quality complying with BS-78. Bends shall be of the nearest standard degree as actually required at site. Heads shall be of the flat or corner type as required. Offsets shall be of the projection as stipulated in the description of the item. Branches shall be single or double as described in the item and shall be of the nearest standard degree as actually required. Standard shoes shall be of overall vertical length, 180 mm for 75 mm dia., 205 mm for 100 mm dia and 275 mm for 150 dia sized pipe from top of socket to lowest tip of shoe. Shoes of longer lengths if used shall be in lengths 300 mm, 375 mm, 450 mm, or 600 mm from top of socket to lowest tip of shoe of as actually required at site.

9.17.5.2 Dimensions

The fittings shall be of the diameter specified in the description of the item. The thickness of the fittings and details of spigots and sockets shall be same as those of the corresponding size of straight pipes. The fittings shall be supplied without ears unless otherwise specifically mentioned in the item. The fittings shall be factory painted with a tar basis composition both inside and outside which shall be smooth and tenacious. Every fitting shall ring clearly when struck all over with a light hard hammer. The fittings shall be of standard size and their individual weights shall conform to the weights given in the Table-Weight of C.I. Rain Water Pipe Fittings.

Sr. No.	Description	75 mm dia	100 mm dia	150 mm dia	unit
		Kgs	Kgs	Kgs	
1	Bends (Plain)	3.20	4.50	9.10	Each
2	Offsets (Plain)				
a)	55 mm projection	2.70	5.00	8.20	Each
b)	75 mm projection	3.20	5.50	9.10	Each
c)	115 mm projection	4.10	5.90	9.50	Each

d)	150 mm projection	4.50	6.40	10.40	Each
e)	225 mm projection	5.00	7.30	11.80	Each
f)	300 mm projection	6.00	8.60	12.70	Each
3	Branches (Plain)				
	Single	5.00	7.30	14.50	Each
	Double	6.80	10	19.10	Each
4	Standard shoes (Plain)	3.20	4.10	8.60	Each
5	Longer shoes (Plain)				
a)	300 mm	3.20	5.00	--	Each
b)	375 mm	4.10	5.50	--	Each
c)	450 mm	5.50	6.40	--	Each
d)	600 mm	7.30	8.60	--	Each
6	Heads	6.40	6.80	11.30	Each
7	Extras:				
a)	For ears cast on any fitting and short pipes	0.90	0.90	1.35	Each
b)	For inspection doors fitted on any fitting	1.80	1.80	2.25	Each

Table 5, Weights of C.I. Rain Water Pipe Fittings (Chapter 9)

Note:

- The above table applies only to rain water fittings which are part of pipe lines fixed on wall face. Permissible tolerance in weight of fittings shall be 5%.
- For fittings to be used with pipe lines to be embedded in masonry, specifications shall correspond with BS 437 of pipe fittings for soil, waste and vent pipes. Fixing and jointing shall be as specified in 9.17.3 (iii)

9.17.5.3 Measurements

The rate shall include in the case of fittings fixed on the face of wall, the cost of all materials and labour involved in all the operations described above including jointing including the supply and fixing the M.S. holder bat clamps in walls and the anchoring concrete. Unless otherwise specified in the description of the item, the rate shall apply for fittings without access doors. In the case of fittings forming part of a rain water pipe line embedded in masonry, the rate shall be for supplying and embedding the fittings in masonry.

9.18 UPVC Pipes for Roof Drain

These pipes and fittings conform to ISO 3633 and EN 1329 and available in 50, 75, 110 and 160 mm outside dia. in standard length of 3 to 4 meters.

Sr. No	Nominal size	Nominal Outside Dia (dn)	Wall Thickness	
			Min	Max
1	50	50	3	3.5
2	75	75	3	3.5
3	110	110	3.2	3.8
4	160	60	3.2	3.8

Table 6, UPVC Pipes for Roof Drain (Chapter 9)

9.18.1 Jointing Methods

1. Solvent Cement Jointing

For jointing pipe to pipe or pipe to fitting with solvent cement, both parts are to be joined must be clean and dry. Chamfer the pipe end and remove any dust or grease from both ends/sides. Apply cement solvent cement using a paint brush on both sides of spigot end and the inside socket, then insert the spigot end fully into the socket edge with a panel or felt tip pen on the pipe. Remove excess solvent cement with dry cloth. The joint may be tested after 24 hours or as per instructions of Engineer-in-Charge.

2. Rubber Ring Push Fit Jointing

Clean pipe's spigot and form the outside and the sealing groove of the fitting from inside. Insert rubber ring into the socket end of the pipe/ fitting. To avoid dislocation during/ after jointing (pipe to fitting or pipe to pipe), always ensure that the rubber ring is fixed in the right direction. Apply the lubricant (soap solution) uniformly to the spigot end and sealing ring. Push the spigot end into the socket containing sealing end, until fully fixed. Prior to insertion mark the position of socket edge on the wall pipe with a pencil or felt tip pen and withdraw the pipe from the socket by approximately 10mm to allow for the thermal expansion.

9.18.2 Measurement

- The fittings shall be measured by numbers. The pipes shall be measured net when fixed correct to a cm. excluding all fittings along its length.
- The rate shall include the cost of all materials and labour involved in all the operations described above including jointing but excluding the supply and fixing of wall plugs and PVC clips which shall be paid for separately.

Note: These pipes shall be used only in shaft or unexposed location to avoid damage to these pipes due to willful act.

9.19 False Ceiling (General)

9.19.1 Description

This specification covers providing and fixing false ceiling under the roof. Unless otherwise specified false ceiling shall be carried out in accordance with the specifications true to dimension and as shown on the drawing.

9.19.2 Material

- Aluminium Alloy Tees shall be of size 1-½" x 1".
- Aluminium Alloy Angles shall be of size 1"x1"
- Plastic plugs of approved quality & steel screws not less than 1½" size shall be used.
- Ceiling Boards as specified.

9.19.3 Operation

Before start the work height of false ceiling shall be marked on the surrounding walls:

- The ceiling area shall be divided into 2 feet sq. panel.
- Unless otherwise specified, the false ceiling shall be laid over angle and tee runners.
- Unless otherwise specified angles and tee runners shall be of aluminum & of specified shade or powder quoted in approved color.
- Angle runners shall be fastened with walls at the correct height by means of plastic plug and screws driven into wall at intervals not more than 2-ft.
- Tee runners shall be suspended with G.I wire 14 SWG anchored with plastic plug and screws driven in roof at intervals not more than 2-ft accurately.
- Tee crosses shall be resting on tee angle runners and fastened tightly.
- Board of specified material size and thickness shall be fixed in the frame.

9.19.4 Measurement

The false ceiling shall be measured by area. The unit for measurement shall be sq.ft / sq. mtr.

9.19.5 Rate

9.19.5.1 Labor Rate

The unit rate for false ceiling shall include the cost of labor involved to carry out false ceiling according to the specifications, fixed in position, at specified height in true lines and level. The rate shall further include the cost of labor employed for following operations.

- Drilling of holes in walls & ceiling.
- Fixing of plastic plug and screws.
- Fastening of tee runners with G.I wire 14 SWG gauge.
- Fastening of angle runners with walls.
- Cutting of ceiling boards in specified size where required.
- Fixing of ceiling boards

9.19.5.2 Composite Rates

The unit rate shall include the cost of all materials required in addition to the labour rate detail in para 9.19.5.1 above.

9.20 Ceiling with Thermophore

General aspects should be according to the section 9.19 of these specifications

9.20.1 Thermophore Sheets

Thermophore Sheets shall be procured from an approved source and shall be of thickness as specified. The thermophore shall comply with ASTM-C578-04 sheets. The thermophore sheets shall be fixed on wooden frame for installation as ceiling.

9.20.2 Frame

Frame of the class of timber and section specified in the description of the relevant item or as ordered by the Engineer-in-Charge shall be provided. The width of the scantlings provided shall be sufficient to provide a minimum nailing surface of 50 mm. The longitudinal and header scantlings shall be so arranged that (a) the sheets can be fixed to form the panel arrangements required as per drawings or as ordered by the Engineer-in-Charge (b) the longitudinal scantling to which the boards are mainly fixed are spaced at 30 to 45 cm centers, the actual spacing selected depending on the width of the cut board in the panel arrangement, (c) all edges of the cut board units are supported either on the longitudinal scantlings or on the header scantlings or on both. The frame shall be given two coats of approved preservative paint (to be paid for separately) before the thermophore sheets are fixed on wooden frame and will be paid for separately. The frame and painting thereof shall be paid for separately unless specifically included in the description of the ceiling item. Bottom surface of the frame shall be checked and corrected to true planes and slopes.

9.20.3 Nails

The sheets shall be fixed to the frame scantling with G.I. headless nails 2.24 mm dia when the joints are to be left exposed. Where the joints will be covered with beadings, the sheets are to be fixed to the frames scantlings with G.I. felt headed (clout) nails 2.5 mm dia. The length of the nails shall generally be equal to thickness of sheet plus 25 mm so that their grip on the framing holding members will not be less than 25 mm.

9.20.4 Fixing

The boards shall be laid with lengths parallel to all joints centered over the framing members. Where joints are to be covered, the boards may be spaced 3 to 6 mm apart as described in the respective manufacturers' specifications. Where joints are to be left exposed the sheets shall be butt laid with their edges abutting in moderate contact, but without having to force them into place. The boards shall be supported and held tight to the frame with timber pieces the latter being moved outwards as the nailing proceeds. The boards are first nailed to the intermediate framing member proceeding from the center of the board outwards, the edges being nailed last.

9.20.5 Finishing

The exposed side of the thermophore sheet frame shall be truly level and plane without any local bulges or sags. The joints shall be truly parallel and/or perpendicular to the walls. The width of joints shall be uniform. Care shall be taken to see that the uniformity of color of the sheets is not spoilt during the fixing operations.

9.20.6 Measurement

Length and breadth of the roofing insulation shall be measured correct to a cm and the surface area worked out in square meter of the finished work. No deduction shall be made for openings of areas up to 40 square decimeters. No extra payment will be made for any extra material or labour involved in forming such openings.

9.21 False Ceiling with Gypsum Board

9.21.1 Description

This specification covers providing and fixing false ceiling with Gypsum Board. Unless otherwise specified false ceiling shall be carried out in accordance with the specifications true to dimension and as shown on the drawing.

9.21.2 Materials

9.21.2.1 Gypsum Board

- It shall conform to the Chapter-8 of Book 1 (Specification for Engineering Material).
- It shall be of approved design and quality.
- Size 2'x2'x3/8".

9.21.2.2 Other Materials

As mentioned in heading 9.19 of these specifications.

9.21.3 All Other Respects

In all other respects the work shall conform to heading 9.19 of these specifications.

9.21.4 Measurement

The false ceiling shall be measured by area. The unit for measurement shall be sq.ft/ sq. meter.

9.21.5 Rate

9.21.5.1 Labor Rate

The unit rate for false ceiling shall include the cost of labor involved to carry out false ceiling according to the specifications, fixed in position, at specified height in true lines and level. The rate shall further include the cost of labor employed for following operations:

- Drilling of holes in walls & ceiling.
- Fixing of plastic plug and screws.
- Fastening of tee runners with G.I wire 14 SWG gauge.
- Fastening of angle runners with walls.
- Cutting of ceiling boards in specified size where required.
- Fixing of ceiling boards

9.21.5.2 Composite Rate

The unit rate shall include the cost of all materials required in addition to the labor rate detail in para 9.21.5.1 above.

9.21 False Ceiling with Plaster of Paris

9.21.1 Description

This specification covers providing and fixing false ceiling with Plaster of Paris under the roof. Unless otherwise specified false ceiling shall be carried out in accordance with the specifications true to dimension and as shown on the drawing.

9.21.2 Materials

9.21.2.1 Plaster of Paris Board/Sheets

- Plaster of Paris shall conform to Chapter- 5 of these specifications.
- Plaster of Paris sheet size 2'x2'x½" of approved design shall be used manufactured at site of work.

9.21.2.2 Other Materials

As mentioned in heading 9.19 of these specifications.

9.21.3 All Other Respects

In all other respects the work shall conform to the heading 9.19 of these specifications.

9.21.4 Measurement

The false ceiling shall be measured by area. The unit for measurement shall be sq.ft/ sq. meter.

9.21.5 Rate

9.21.5.1 Labor Rate

The unit rate for false ceiling shall include the cost of labor involved to carry out false ceiling according to the specifications, fixed in position, at specified height in true lines and level. The rate shall further include the cost of labor employed for following operations.

- Drilling of holes in walls & ceiling.
- Fixing of plastic plug and screws.
- Fastening of tee runners with G.I wire 14 SWG gauge.
- Fastening of angle runners with walls.
- Cutting of ceiling boards in specified size where required.
- Fixing of ceiling boards

9.21.5.2 Composite Rate

The unit rate shall include the cost of all materials required in addition to the labor rate detail in heading 9.21.5.2 above.

9.22 False Ceiling with HDF Boards

9.22.1 Description

This specification covers providing and fixing false ceiling with HDF Board under the roof. Unless otherwise specified false ceiling shall be carried out in accordance with the specifications true to dimension and as shown on the drawing.

9.22.2 Material

9.22.2.1 HDF Board

- HDF board shall be of approved design, density, and of specified manufacturer.
- Size 2"x2"x3/8" or as specified.

9.22.2.2 Other Materials

As mentioned in Heading 9.19 of these specifications.

9.22.3 All Other Respects

In all other respects the work shall conform to Heading 9.19 of these specifications.

9.22.4 Measurement

The false ceiling shall be measured by area. The unit for measurement shall be sq.ft/ sq. meter.

9.22.5 Rate

9.22.5.1 Labor Rate

The unit rate for false ceiling shall include the cost of labour involved to carry out false ceiling according to the specifications, fixed in position, at specified height in true lines and level. The rate shall further include the cost of labour employed for following operations.

- Drilling of holes in walls & ceiling.
- Fixing of plastic plug and screws.
- Fastening of tee runners with G.I wire 14 SWG gauge.
- Fastening of angle runners with walls.
- Cutting of ceiling boards in specified size where required.
- Fixing of ceiling boards

9.22.5.2 Composite Rate

The unit rate shall include the cost of all materials required in addition to the labour rate detail in heading 9.22.5.1 above.

9.23 Wooden Ceiling

9.23.1 Boards

- Boards shall be of the class of timber and of finished thickness as specified in the description of the item and shall be in accordance with the general specifications for wood work. Only selected boards of uniform width shall be used. Unless otherwise specified in the description of the item or shown in the drawings, the width of boards selected for use shall not be less than 100 mm nor more than 150 mm.
- The specific width of boards once selected within these two limits shall be maintained throughout and shall not be varied except in the first and last lines of boards adjustment to the two walls, where remaining odd width shall be adjacent equally on both sides. The maximum length of the board in the finished work shall be 180 cm. The minimum length of board in the finished work shall be such that it will span at least two spacing of the supporting frame work except where shorter lengths are unavoidable, depending on the arrangements of the lines of heading joints which shall be carried out to the pattern ordered by the Engineer-in-Charge. The boards shall be planed true on the exposed side.
- Unless stipulated otherwise in the description of the item, the longitudinal joints of the boards shall be tongued and grooved, while the heading joints shall be of the square butt type and shall occur under the centre line of the supporting joint. Heading joints in adjacent boards shall not be placed over the same joists, those in alternate boards being arranged in the same line, except where the joints are to be concealed by headings.

9.23.2 Frame

Timber frame of the class of timber and section specified in the description of the item or as ordered by the Engineer-in-Charge shall be provided. The width of the frame scantling shall not be less than 50 mm. The arrangements and spacing of the frame scantling shall be as per design furnished. The frame shall be given two coats of approved preservative paint before the boarding is screwed. The frame and paints thereof shall be paid for separately unless specifically included in the description of the item. M.S. angles shall be used for suspending the frame and paid for separately. The bottom surface of the frame shall be checked and corrected to true plans and slopes as specified and shown on drawings.

9.23.3 Mild Steel Screws

Screws shall be got approved from the Engineer-in-Charge before fixing. They shall be of the slotted counter sunk head type of length not less than the thickness of the board plus 20 mm. The designation number shall not be less than 9 for screws of length 40 to 50 mm and shall not be less than 6 for screws of length 25 to 35 mm.

9.23.4 Fixing

The outer lines of boards shall be accurately fixed, parallel and close to the wall. Each subsequent plank shall be carefully jointed up. The boards shall be fixed to the frame scantling above with two screws at each of frame and one at every intermediate joist. The screws shall be counter sunk and the screw holes filled with putty or sloping out wax. The unexposed faces of planks shall be painted with wood preservative before fixing.

9.23.5 Finishing

The exposed side of the boards shall be truly level and plane. The joints shall be truly parallel and/or perpendicular to the walls. Beadings shall then be fixed to the ceiling, to the size and pattern required. These shall be measured and paid for separately unless specifically included in the description of the ceiling item.

9.23.6 Measurement

- Length and breadth shall be measured correct to a cm. Areas shall be worked out to nearest 0.01 sqm. The superficial area of the finished work ceiling shall be measured in square meters.
- No deduction in measurements shall be made for openings of areas up to 40 square decimeters. Nothing extra shall be payable either for any extra material or labor involved in forming such openings. For openings exceeding 0.40 sqm in area, deductions in measurements for the full opening will be made and, in such case, any labor involved in making these openings shall be paid for separately in running meters.
- Wooden ceiling of boarding's fixed to curve surfaces in narrow widths shall be measured and paid for separately and shall include making the joints to proper splay.
- Circular cutting and waste shall be measured and paid for separately in running meters.

9.24 Metallic Ceiling

Metallic ceilings are good for that where frequent revisions and Maintenance activities take place.

9.24.1 Material

- Perforated/unperforated Aluminum/steel Tiles of size 600mmx600mmx0.7mm
- Material should be used after powder coating, thickness of coating should be 60 µm, or as per the instructions of engineer in charge.

9.24.2 Construction Requirement

A primary grid system should be maintained by contractor having maximum rigidity of the ceiling construction. This will also minimize the number of hangers and provide for greater flexibility during installation. After installation of the edge trims, the primary grid upper carriers should have installed and the lower carriers are secured to the upper ones using coupling clips. Other respect of metallic ceiling should be as per the heading 9.19 of these specifications.

9.24.3 Measurement & Rate

Measurement for metallic ceiling should be done in sq. ft. Rate should be included of purchasing, transporting and fixing of metallic ceiling in all respect on site and also included of labor rate. No extra charges will be given to contractor for removing and fixing of substandard work.

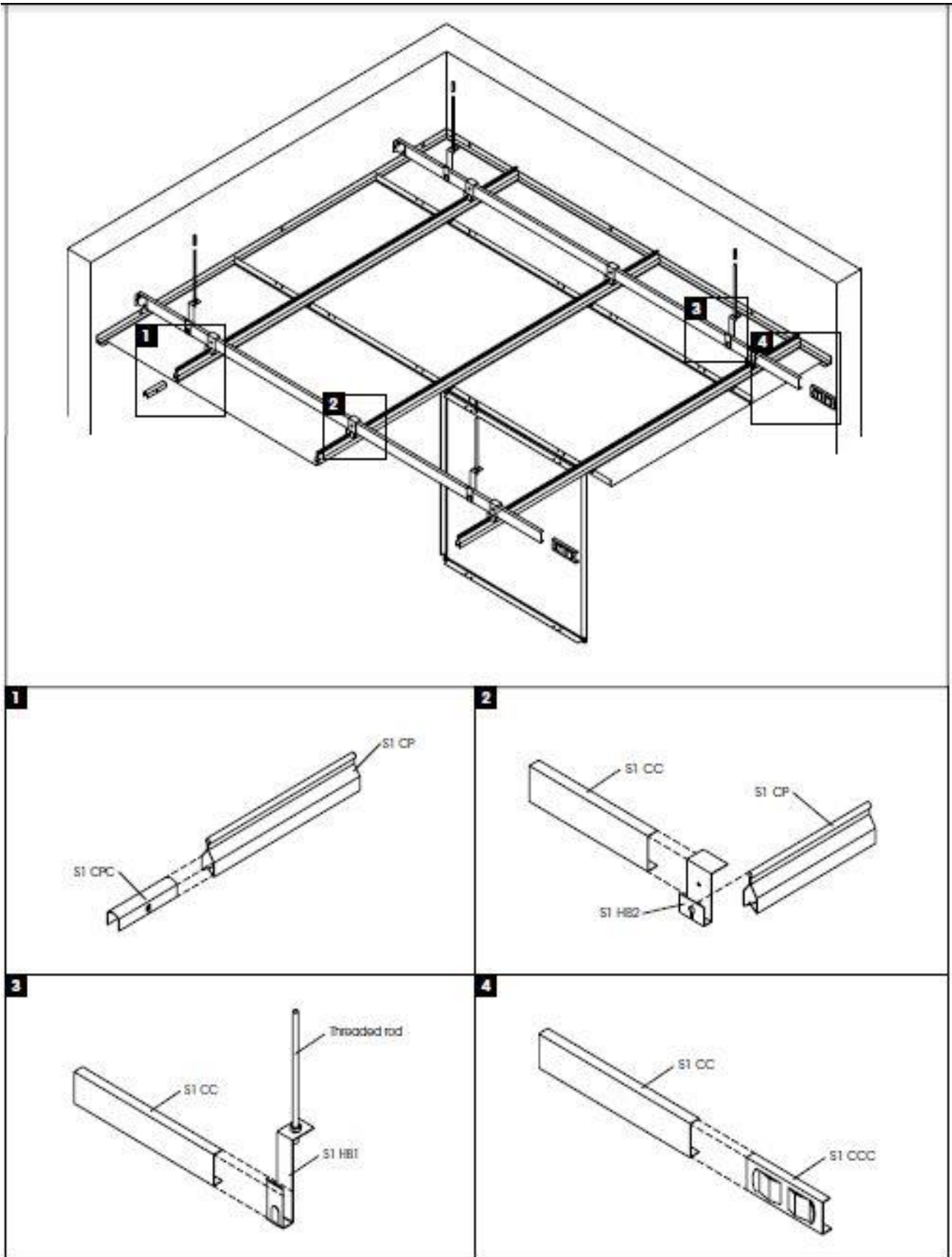

Figure 1 Metallic Ceiling clip in tile

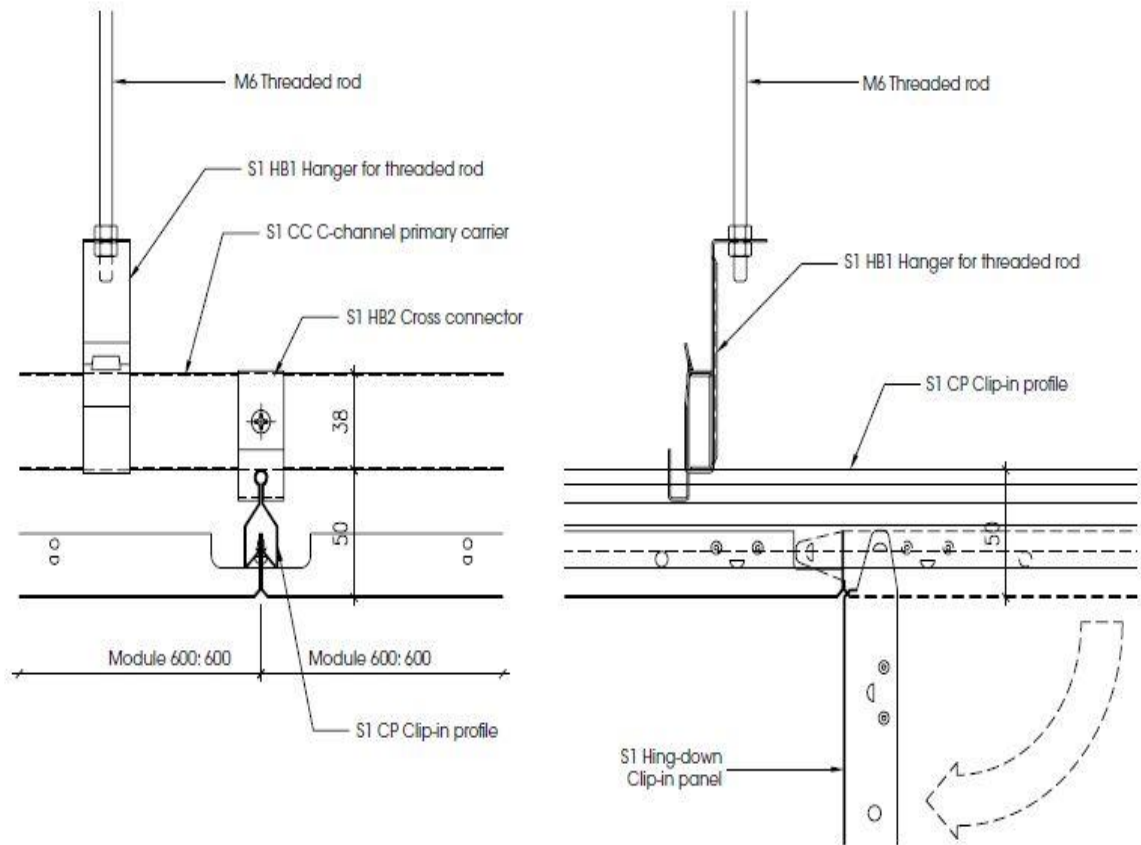

Figure 2 Cross section of Clip Metallic ceiling

Contents

CHAPTER 10	FLOORING	5
10.1	General	6
10.1.1	Glossary	6
10.1.2	Characteristic of Good Flooring	7
10.2	Earth Flooring	10
10.2.1	Description	10
10.2.2	Materials	10
10.2.3	Laying and Consolidation	10
10.2.4	Measurements	10
10.2.5	Rates	10
10.3	Mud Flooring	11
10.3.1	Description	11
10.3.2	Materials	11
10.3.3	Construction Requirements	11
10.3.4	Measurements	11
10.3.5	Rates	11
10.4	Base for Flooring	12
10.4.1	Scope	12
10.4.2	Materials	12
10.4.3	Construction Requirements	12
10.4.4	Measurements	13
10.4.5	Rates	13
10.5	Brick or Tile Flooring	13
10.5.1	Description	13
10.5.2	Materials	13
10.5.3	Construction Requirement	13
10.5.4	Measurements	15
10.5.5	Rates	15
10.6	Flagstone Flooring	16
10.6.1	Description	16
10.6.2	Materials	16
10.6.3	Construction Requirements	16
10.6.4	Measurements	17
10.6.5	Rate	17

10.7 Marble Flooring	17
10.7.1 Description	17
10.7.2 Material	18
10.7.3 Construction Requirements	18
10.7.4 Measurements	19
10.7.5 Rates	19
10.8 Glazed Tile Flooring	19
10.8.1 Description	19
10.8.2 Materials	19
10.8.3 Construction Requirement	20
10.8.4 Measurement	21
10.8.5 Rates	21
10.9 Mosaic Tile Flooring	22
10.9.1 Description	22
10.9.2 Materials	22
10.9.3 Manufacturing of Tiles	22
10.9.4 Construction Requirements	23
10.9.5 Measurements	24
10.9.6 Rate	24
10.10 Conglomerate Flooring (Single Coat)	25
10.10.1 Description	25
10.10.2 Materials	25
10.10.3 Construction Requirements	25
10.10.4 Measurements	25
10.10.5 Rate	25
10.11 Conglomerate Flooring (Two Coat)	27
10.11.1 Description	27
10.11.2 All Other Respects	27
10.11.3 Measurements	27
10.11.4 Rate	27
10.12 Terrazzo/mosaic Flooring	28
10.12.1 Description	28
10.12.2 Materials	28
10.12.3 Construction Requirement	28
10.12.4 Measurement	29
10.12.5 Rates	30

10.13	Dry Brick Paving	31
10.13.1	Description.....	31
10.13.2	Materials	31
10.13.3	Preparing Surface	31
10.13.4	Laying.....	31
10.13.5	Measurement.....	31
10.13.6	Rates.....	31
10.14	Wooden Flooring	31
10.14.1	Description.....	31
10.14.2	Floor Bearers: Ground Floors	32
10.14.3	Floor Bearers: Suspended Floors	32
10.14.4	Floor Bearers Material and Fixing	32
10.14.5	Boarding Material and Size.....	32
10.14.6	Preservative.....	32
10.14.7	Joints.....	32
10.14.8	Planking, Method of Laying.....	32
10.14.9	Nails and Screws.....	33
10.14.10	Planning.....	33
10.14.11	Measurement.....	33
10.14.12	Rate.....	33
10.15	Rubber Flooring	33
10.15.1	Scope.....	33
10.15.2	Materials	33
10.15.3	Composition	33
10.15.4	Base.....	33
10.15.5	Laying.....	34
10.15.6	Curing.....	34
10.15.7	Measurement.....	34
10.15.8	Rate.....	34
10.16	Laminate Flooring	35
10.16.1	Sub Floors Requirements for Laminate Flooring	35
10.16.2	Measurement.....	36
10.17	Asphalt Flooring	36
10.17.1	Scope.....	36
10.17.2	Materials	36
10.17.3	Base.....	36

10.17.4	Laying.....	36
10.17.5	Finishing.....	37
10.17.6	Measurement.....	37
10.18	Muram Flooring	37
10.18.1	Scope.....	37
10.18.2	Materials	37
10.18.3	Preparing Surface	37
10.18.4	Laying.....	37
10.18.5	Measurement.....	38
10.19	PVC Tiles/Sheet Flooring	39
10.19.1	General.....	39
10.19.2	Types of PVC Flooring/Tiles.....	39
10.19.3	Installation Method	39
10.20	Glass Flooring.....	42
10.20.1	Laminated Glass Floors	42
10.20.2	Installation Requirements for Laminated Glass Flooring	42
10.21	Skirting and dado.....	43
10.22	Porcelain Tile Flooring.....	44
10.22.1	Description.....	44
10.22.2	Materials	44
10.22.3	Construction Requirement	44
10.22.4	Measurement.....	45
10.22.5	Rates.....	45
10.23	Granite Flooring	46
10.23.1	Description.....	46
10.23.2	Material	46
10.23.3	Construction Requirements	46
10.23.4	Measurements.....	47
10.23.5	Rates.....	47
10.24	Polyurethane Floor System.....	49
10.24.1	Scope	49
10.24.2	Material Requirement	49
10.24.3	Construction Requirements	49
10.24.4	Measurement & Payment	50

CHAPTER 10**FLOORING****References:**

Sr.#	Standard Name	Description
AASHTO		
1.	AASHTO T-191-02.	Standard Method of Test for Density of Soil In-Place by the Sand-Cone Method.
ASTM		
2.	ASTM-D 2859	Standard Test Method for Ignition Characteristics of Finished Textile Floor Covering Materials.
3.	ASTM-D 3564	Standard Practice for Application of Floor Polishes to Maintain Vinyl Composition Tile or Flooring.
BS		
4.	BSS 3260	PVC (vinyl) asbestos floor tiles.
5.	BSS 3261	Unpacked flexible PVC flooring

10.1 General

10.1.1 Glossary

Floor: The tiers or levels which divide a building in two stages or storeys are called floors. These are made of materials quite different both in composition and construction. They range from relatively thin covering, contributing little or no structural strength to a building, too much thicker materials capable of withstanding reasonable stresses, and in some design, essential to the strength of the building. The selection of proper floor has an important bearing on the building. It affects its appearance, usefulness and the cost of upkeep.

Types of floor

Earth floors: These floors are made of good earth. Earth is filled to the required level in layers, with each layer not exceeding 6 inches in thickness. Each layer is well watered + compacted before placing the next layer. These floors are generally used for stables, cattle sheds etc.

Mud floors: Earth floors intended for human occupation are provided with 1" thick mud plaster surface followed by gobri leaping.

Brick floors: Brick floors are very common in areas where good, hard and well-burnt bricks are cheap and readily available. They are very durable, fire resistant and generally used for stores and godowns.

Tile floors: Tiles are placed on lean concrete. A thin layer of 1:2 cement mortar is placed over the floor base and tiles of required material shape, size and thickness are placed over the floor base. Some of the most common types of tiles used are:

Clay Tile: They are manufactured in different shapes and designs. Most common size available in the market are (i) 12"x6"x2" (ii) 12"x6"x1 ¼" (iii) 9"x4½"x1½".

Cement concrete/ Mosaic tiles: They are precast tiles and are made general in sizes (i) 6"x6" (ii) 8"x8" (iii) 9"x9" (iv) 12"x12" usually 1" thick.

Glazed tiles: They are made of ball clay, China clay, China stone and flint. They are of two kinds: earthenware glazed and colour enamels and are available in different colours and sizes.

Marble & other varitis of building stone floor: Marble slabs are laid over bedding mortar of 1:2 cement sand evenly spread on a base. They are so laid that the joints are very fine i.e. not more than 1/16 of an inch thick which are well grouted in the cement putty of colour matching to the marble. These slabs are available in different colours, shapes, size and are laid in various patterns.

Flagstone Floor:	It is composed of chisel dressed slabs or flags of stone laid to proper level on the floor base.
Cement concrete floors:	It comprises cement concrete topping laid in panels over a floor base. It is laid as single or double layer. Thickness of topping various with requirement.
Terrazzo floors:	Terrazzo-wearing surfaces are constructed in a manner similar to concrete wearing surfaces, but a special aggregate of marble chips or other decorative material is always used and this aggregate is expose by grinding the surface.
Wooden floors:	Wooden flooring is usually provided in places, places like dancing halls, auditoria. Wooden floors should not only be stiff edge of hard rigid for the maximum load that they have to carry but should also be perfectly smooth.
Single floor:	Wooden planking, in this case, rests in the single system of bridging joists which span the opening. These joists in turn rest on wall plate on either end and have to be as stiff as possible so that there is not difficulty in nailing planking to them. The basic requirement of a bridging joist is its stiffness and rigidity for the maximum load the floor is to carry. For this purpose, the timber is usually of greater strength than considered necessary by the usual design calculations. The bridging joists have a sufficient breadth (normally not less than 2 inches) and are placed one foot apart. In general use, the single flooring does not have a span more than 12 feet since there is a danger of the joist bulking or bending sideways. To prevent bulking, they are strutted apart.
Double floor:	In this type of floors the bridging joists do not span the whole room but rest on other joists placed at right angle to them called the binding joist or binders. These binder joists are generally placed 6 to 8 feet apart and rest on wall.
Framed floors:	It is not possible to have either a single or a double system of joists where the span is greater. In such cases another timber in the shape of a girder is added and the binding joists are framed into the main girder.

10.1.2 Characteristic of Good Flooring

10.1.2.1 Comfort

Comfort under foot is determined by the shock-absorbing qualities, sure-footness, evenness of surface and conductivity. A floor which is a good heat conductor will always give a cool feeling.

The most comfortable floors to work on are cork tiles and rubber, wood and asphalt mastic are also quite satisfactory, but concrete, terrazzo, clay tile, marble and bricks are tiresome and cold.

10.1.2.2 Noiselessness

Cork tile and rubber floors are practically noiseless. Wood and asphalt mastic floors, though less satisfactory are not very noisy. Concrete, clay tile, marble, slate and bricks are the noisiest of the flooring materials.

10.1.2.3 Fire Resistance

Concrete, clay tile and bricks are the most fire-resistant floor surfaces. Next in line are terrazzo marble and slate. Rubber and wood are combustible, but if laid on a fire-proof base they are not considered a serious defect in a fire-proof building.

10.1.2.4 Sanitation

From the point of view of sanitation, a floor surface must be non-absorbent and could be easily cleaned. Joints which are not watertight lead to insanitation. Terrazzo, clay tile and marble are the most sanitary floor surfaces. Concrete presents difficulty in cleaning, and wood is an unsatisfactory material on account of its porosity and the presence of open joints.

10.1.2.5 Acid and Alkali Resistance

This means immunity from damage by occasional spilling of strong acid solution and resistance to the continuous use of soap, cleaning and scouring compound and disinfectants. Clay tile is the most satisfactory floor surface in this respect; asphalt mastic is also quite resistance; terrazzo, marble and concrete are considered to be sufficiently resistant for ordinary purpose.

10.1.2.6 Grease, Oil Resistance

Grease and oil are not absorbed by polished clay tile and do not affect it. They are however absorbed by wood, brick, concrete, terrazzo and therefore spoil their appearance though do not seriously affect their durability.

10.1.2.7 Dampness

Clay tile, brick, concrete, terrazzo and asphalt tile are not affected by dampness and are suitable for use on floors located below grade such as in the basement. Wood, rubber, cork tile and other similar materials are not suitable for such location.

10.1.2.8 Indentation

The flooring materials such as clay tile, terrazzo, concrete and marble do not suffer indentation from chair legs, heels of shoes and other objects which rest on them or strike them. Materials like rubber yields considerably under such load but recovers quite well when the load is removed. Asphalt tiles and asphalt mastic, however, become permanently indented.

10.1.2.9 Maintenance

Polished tile, marble, terrazzo and rubber tile floors are easily cleaned and require little care in their maintenance; hardwood floors are fairly easy to clean when in a good condition, but require frequent surface treatment; asphalt tiles are easily cleaned, but should receive surface treatment occasionally; cork is not easy to clean and requires surface treatment. Concrete is not as easy to clean as terrazzo or marble, if it is not painted or waxed. Painting makes cleaning easy but requires frequent renewal. The monolithically constructed floors such as terrazzo and concrete are difficult to repair satisfactory. Floors composed a separate unit of tile, slate, or marble are more easily repaired, but required skilled mechanics do it. The maintenance cost of wood block, brick or concrete floors is relatively low, except under

extremely severe traffic. With the exception of concrete these materials are easily repaired as they require no surface treatment.

10.1.2.10 Initial Cost

One of the important factors governing the selection of a floor is its initial cost. It may be noted here that even the most expensive materials do not possess all the features which are considered desirable.

10.2 Earth Flooring

10.2.1 Description

Unless otherwise specified, earth flooring shall be constructed in accordance with the following specifications.

10.2.2 Materials

Earth (clay) shall be conform to Chapter-3 of Book-1(Specification for Engineering Material).

10.2.3 Laying and Consolidation

Earth shall be placed in layers and shall be sprinkled with water and rammed to such an extent that a layer of loose earth evenly spread is reduced to 6 inches in thickness. The consolidated surface shall be such that a very faint impression can be made on it with the heel or a boot or the blow of a rammer.

10.2.4 Measurements

Earth flooring shall be measured by the superficial area of the floor. The unit of measurement shall be 100 ft².

10.2.5 Rates

10.2.5.1 Labor Rate

The unit rate shall include the labour required for the laying and consolidation of earth as per above specifications.

10.2.5.2 Composite Rate

The unit rate shall include the cost of earth supplied at site in addition to the labour as detailed in the above specifications.

10.3 Mud Flooring

10.3.1 Description

Unless otherwise specified, mud flooring shall be laid in accordance with the following specifications.

10.3.2 Materials

- a. Earth (clay) shall conform to specifications as contained in Chapter 3 of heading 3.1 of Book-1 (Specification for Engineering Material).
- b. Mortar shall conform to specification as contained in 5.2.1 for Mud mortar.

10.3.3 Construction Requirements

10.3.3.1 Laying and Compaction

After doing earth filling as per 3.10, the surface shall be finished with one-inch thick mud plaster with gobri leaping conforming to specifications as contained in 11.1.10 for Mud plaster of these specifications.

10.3.4 Measurements

Mud flooring shall be measured by the superficial area of the floor. The unit of measurement shall be 100 ft² or m².

10.3.5 Rates

10.3.5.1 Labor Rate

The unit rate shall include the cost of labour for mud plastering and "gobri leaping".

10.3.5.2 Composite Rate

The unit rate shall include the cost of labour, earth, chopped "bhoosa" used in mud plastering and cow-dung.

10.4 Base for Flooring

10.4.1 Scope

Unless otherwise specified, the base of all ground floors shall be laid in accordance with the following specifications.

10.4.2 Materials

- c. Earth (clay) shall conform to the specifications as contained in Chapter 3 of heading 3.1 of Book-1(Specification for Engineering Material).
- a. Sand shall conform in all respects to the specification as contained for fine aggregate of heading 6.4. of Book-1(Specification for Engineering Material).
- b. Coarse aggregate shall consist of crushed stone or shingle and conform to the specification as contained in 6.5 of Book-1(Specification for Engineering Material) for aggregate for base of floor & foundation.
- c. If brick ballast is used it shall conform to 6.7 of Book-1(Specification for Engineering Material).
- d. Water shall conform to the specification contained in book-1(Specification for Engineering Material) of Chapter-2 "Water".

10.4.3 Construction Requirements

10.4.3.1 Preparation of Subbase

Earth filling shall be done up to the specified level in accordance with specification as contained in 3.10. The sub-base shall be properly levelled before sand filling.

10.4.3.2 Sand Filling

Sand shall be placed in position to the required depth, as shown on the drawings as required in writing by the Engineer-in-charge. It shall be well compacted in layers not exceeding 6 inch in thickness 95% of maximum dry density as per AASHTO determined in accordance with AASHTO T-191-02.

10.4.3.3 Coarse Aggregate Laying & Ramming

Coarse aggregate shall be laid in a uniform layer of specified thickness, absolutely true and parallel to the required level of the finished surface and to the entire satisfaction of the engineer-in-charge. During the progress of the work, the Engineer or his representative shall make density tests in accordance with AASHTO T-191, modified to include only material passing a ¾-inch sieve, and if he finds the density is less than 95% of the maximum density, the Contractor shall perform additional rolling or tamping as may be necessary to obtain that density.

10.4.3.4 Surface to Bond with Topping

The surface shall be kept wet and protected from earth, dirt or other foreign matters before laying the topping.

10.4.3.5 Level and slopes

Unless otherwise specified, the base shall be perfectly levelled. A slope of 1:64 shall, however, be provided in verandahs and bath rooms.

10.4.4 Measurements

The components of the base for floors specified in heading 10.4.3.2 and 10.4.3.3 shall be measured in volume separately. The unit of measurement shall be 100 ft³ or m³.

10.4.5 Rates

10.4.5.1 Labor Rate

The unit rate shall include preparation of sub-base, laying and ramming of base components via. 10.4.3.2 and 10.4.3.3, use of tools and plants required for carrying out of the work in accordance with the above specifications.

10.4.5.2 Composite Rate

The unit rate shall include cost of all the materials required in the above operations in addition to the labour rates detailed in Heading 10.4.5.1.

10.5 Brick Tile and Cement Concrete Flooring

10.5.1 Description

Unless otherwise specified, brick or tile flooring shall be laid in accordance with the following specifications.

10.5.2 Materials

- a. Bricks or tiles shall conform to the specifications as contained in heading 4.1 of Book-1 (Specification for Engineering Material) for Clay Bricks and heading 4.2 of Book-1 (Specification for Engineering Material) for Clay Tiles of these specifications.
- b. Mortar shall conform to the specifications as contained in Chapter-5 of these Specifications.
- c. Cement concrete tile of specified color & size.

10.5.3 Construction Requirement

10.5.3.1 Base for Ground Floor

For ground floor the base shall be laid as per specifications contained in Heading 10.4.3.

10.5.3.1.1 Base for 1st and Subsequent Floors/Terraces

For first and subsequent floors, the base shall comprise of specified thickness of coarse aggregate or brick ballast. For terraces, the base shall comprise of bitumen at 34lbs./100ft² followed at specified thickness of brick ballast or coarse aggregate. Size of aggregate shall not exceed 1½" gauge.

10.5.3.2 Wetting of Bricks/Tiles

Bricks or tiles shall be wetted in accordance with specifications as contained in Heading 3.1 for Brickwork (General).

10.5.3.3 Pattern

The laying of bricks or tiles shall be plain, diagonal, herring bone or any other specified pattern.

10.5.3.4 Joints

- Where pointing is not to be done, the joints shall not exceed 3/16 inch in thickness. The mortar oozing out of the joints shall be struck off with trowel or wiped off with damp cloth.
- Where pointing is to be done, the joints shall not exceed 3/8-inch in thickness. The mortar in the joint shall be raked out one inch deep, while it is still green.

10.5.3.5 Pointing

Unless otherwise specified, the joints shall be flush pointed with specified mortar.

10.5.3.6 Preparation of Base

Before laying bricks/tiles the surface of the base shall be washed and scrubbed with wire brushes.

10.5.3.7 Thickness of Bedding Mortar

The floor shall be laid on 3/4-inch thick bed of specified bedding mortar spread evenly on the base.

10.5.3.8 Laying of Bricks/Tiles

Bricks/tiles shall be laid in position with specified mortar on the bedding mortar.

10.5.3.9 Protection

Flooring shall be allowed to mature undisturbed, and protected from the effects of weather. It shall be kept wet for at least 7 days after completion. If pointing is to be done, it shall be kept wet for at least 7 days after the completion of pointing.

10.5.3.10 Surface

Surface shall be finished to specified levels. All joints shall be uniform, parallel and square. Bricks shall be rubbed to ensure this where it is very necessary, without extra cost.

10.5.3.11 Edges with Bull nosed Bricks

No damaged brick or tile shall be used. Bats shall not be used except to close any course of bricks or tiles. Unless otherwise specified, the overhanging edge of the paving shall be finished off by special bull-nosed bricks.

10.5.3.12 Cement Concrete Tiles

- Cement tile shall be of an approved quality as specified.
- All tiles shall be laid in water for 36 hours before they are laid.
- The joints shall not be more than 1/16 of an inch which shall be grouted with cement, matching the colour of the tiles.
- When necessary the tiles shall be cut with wire saw to the exact size having a clean sharp edge so as to have fine joints.
- Saw dust shall be used as the work proceeds for removing stains etc.

10.5.4 Measurements

The measurement of brick or tile flooring shall be by the superficial area. Its unit of rate shall be 100 ft³ or m³.

10.5.5 Rates

10.5.5.1 Labor Rate

The unit rate shall include: -

- a. Watering and cleaning of base in case of ground floors and scrubbing and washing of the base slabs in case of upper floors.
- b. Laying of bedding mortar over the base.
- c. Laying of bricks/tiles in specified mortar over the bedding mortar.
- d. Protection and curing of the work.
- e. Cost of providing tools and plants required for carrying out the work in accordance with the above specifications.

The labour for pointing is not included.

10.5.5.2 Composite Rate

The unit rate shall include the cost of all the materials supplied at site as specified above, in addition to the labour rate detailed in Heading 10.5.5.1 above. The rate, however, does not provide for laying and cost of bitumen and brick ballast or coarse aggregate.

10.6 Flagstone Flooring

10.6.1 Description

Unless otherwise specified, flagstone flooring shall be laid in accordance with the following specifications.

10.6.2 Materials

10.6.2.1 Stone

Stone shall conform to the specifications as contained in Chapter-7 of Book-1(Specification for Engineering Material).

10.6.2.1.1 Quality

Flagstone shall be hard, durable and fine-grained. Flagstone shall be procured from the approved query.

10.6.2.1.2 Size of Flagstone

Flagstone shall not be less than one and a half inches thick. The length and breadth shall not be less than 12 inches and more than 30 inches. The size of flagstone shall be such as to give uniform parallel courses.

10.6.2.1.3 Dressing

Flagstone shall be chisel dressed so as to have a flat surface, free from windings. All edges shall be accurately dressed, truly square to their full depth. Flagstone projecting over the edges of verandahs or steps shall have their outer edges bull-nosed.

10.6.2.2 Mortar

Specified mortar shall conform to Chapter-5 of these specifications as actually specified.

10.6.3 Construction Requirements

10.6.3.1 Preparation of Base Surface

The base shall be laid in accordance with the Heading 10.4.

10.6.3.2 Soaking

Flagstone shall be soaked in water for at least one hour before laying.

10.6.3.3 Thickness of Bedding Mortar

Flags shall be laid over specified bedding mortar not more than $\frac{3}{4}$ -inch thick.

10.6.3.4 Laying of Flags

Flags shall be placed in position and brought down to the required finished level and the joints shall then be filled with specified mortar.

10.6.3.5 Pattern

Flags shall be laid in the specified pattern. The courses shall be of uniform width and, unless otherwise specified, parallel to the wall having the main entrance. Flags shall break joint in adjacent courses by not less than 8 inches.

10.6.3.6 Joints

The thickness of joints shall not be more than 1/8 of an inch. Unless otherwise specified, the mortar in joints shall be made flush with a trowel.

10.6.3.7 Pointing

If pointing has been specified the flags shall be laid against wood or iron strips of uniform thickness, so as to form joints not less than ¼ inch wide. When a row of flags is laid, the strips shall be removed and the open joints shall at once be filled with specified mortar, and shall then be flush pointed with specified mortar.

10.6.3.8 Protection and Curing

The floor shall be protected from the effects of weather. During the progress of work and for 7 days after laying, the floor shall be kept watered. Three clear days shall be given for setting before anyone is allowed to walk over, but no weight shall be brought on the surface till 7 clear days have elapsed after the completion of laying.

10.6.4 Measurements

The flagstone flooring shall be measured by superficial area. The unit of measurement shall be 100 ft² or m².

10.6.5 Rate**10.6.5.1 Labor Rate**

It shall include: -

- a. Watering & cleaning of bases according to Heading 10.5.3.6.
- b. Laying of ¾ inch thick bedding mortar.
- c. Laying of flagstone and filling of joints with specified mortar.
- d. Curing and protection of work.
- e. Use of all tools and plants required for carrying out work as per above specifications.

The labour for pointing is not included in the rate.

10.6.5.2 Composite Rate

The unit rate shall include the cost of all the materials supplied at site of work as per above specifications, in addition to the labour rate detailed in Heading 10.6.5.1 above.

10.7 Marble Flooring**10.7.1 Description**

Unless otherwise specified marble flooring shall be constructed in accordance with the following specifications.

10.7.2 Material

10.7.2.1 Marble Stone Slabs

Marble stone slab shall be of the size, type and colour as specified. All slab shall have a true plain surface and shall be accurately square, truly square at edges to the full thickness.

10.7.2.2 Portland Cement Concrete

Portland cement concrete screed 1" thick of nominal maximum 1:2:4.

10.7.2.3 Mortar

Cement sand mortar ratio 1:3 conforming to the specification as contained in Chapter-5 of these specifications.

10.7.3 Construction Requirements

10.7.3.1 Preparation of Base

The base shall be laid in accordance with the Heading 10.4. Before laying marble slabs, the surface of the base shall be washed and scrubbed with wire brushes.

10.7.3.2 P.C.C. Screed

P.C.C. Screed 1" thick will be laid on this base.

10.7.3.3 Bedding Mortar

Marble stone slabs shall be laid over bedding mortar not more than $\frac{3}{4}$ " thick.

10.7.3.4 Joints

No joints shall be more than 1/16 of an inch in thickness. Slabs projecting over the edges of verandah or steps shall have their edges finished with a bull-nosed ending.

10.7.3.5 Laying

Slabs shall be laid in position on bedding mortar in specified pattern. The joints shall be filled with specified putty.

10.7.3.6 Levels

The surface of marble slabs when laid shall be perfectly true, level, projected or sloped.

10.7.3.7 Protection and Curing

The floor shall be protected from the effects of weather. During the progress of work and for 10 days after laying, the floor shall be kept watered. Three clear days shall be given for setting before anyone is allowed to walk over, but no weight shall be brought on the surface till 7 clear days have elapsed after the completion of laying.

10.7.3.8 Grinding

After the marble slab has hardened enough, it shall be ground with an approved type of grinding machine wing rapid cutting carborundum stones. The floors shall be kept wet during the grinding process. All materials ground off shall be removed by sweeping and flushing with water. Then the floor surface shall receive a second grinding followed by final grinding to remove the film of cement paste and to give the floor a polish. It shall then be thoroughly washed and all surplus material removed.

10.7.3.9 Polishing & Finishing

The surface after grinding will be left undisturbed for a period of one week. After this period the surface shall be cleaned of dirt and dust by rubbing gently with pumice stone using sufficient water. If the surface has somehow been dirtied it must be washed with washing soda. Then the surface will be cleaned and rubbed hard with Oxalic acid (1:10 solution) using felt or an old blanket. Thereafter the surface shall be cleaned and washed with plenty of water. After the surface has dried it will be finished to the satisfaction of the Engineer-in-charge with wax polish by using polishing machine.

10.7.4 Measurements

The measurement of marble flooring shall be done by the superficial area. The unit of measurement shall be 100 ft² or m².

10.7.5 Rates

10.7.5.1 Labor Rate

The unit rate shall include: -

- a. Washing, scrubbing and cleaning of base (in the case of ground floor).
- b. Laying of bedding mortar.
- c. Laying of marble slabs over bedding mortar and RCC screed.
- d. Filling of joints with white/grey cement with matching pigment.
- e. Levelling, curing, grinding & polishing of marble slabs as per these specifications.
- f. Use of all the tools and plants required for carrying out work in accordance with these specifications.

10.7.5.2 Composite Rate

It includes the cost of all the materials supplied at site of work as per these specifications, in addition to the labour rate detailed in Heading 10.7.5.1.

10.8 Glazed Tile Flooring

10.8.1 Description

The tiles shall be of approved make. These will be of ceramic tiles with one face glazed and shall be white or coloured as specified in the schedule of quantities. The thickness used shall be ¼" or 3/8" as specified.

Unless otherwise specified, tile flooring shall be laid in accordance with the following specifications.

10.8.2 Materials

- Tiles shall conform to the specifications as contained in Chapter-5 of Book-1 (Specification for Engineering Material) for Glazed Tiles.
- Mortar shall conform to the specifications as contained in Chapter-5 of book-2 of these specifications.

10.8.3 Construction Requirement

10.8.3.1 Base and Its Preparation

For ground floor the base shall be laid as per specifications contained in Heading 10.4 The base 1st floor and subsequent floors shall be prepared in accordance with Heading 10.5.3.1.1.

10.8.3.2 Wetting of Tiles

Tiles shall be wetted in water for 12 hours before they are laid in position.

10.8.3.3 Pattern

The laying of tiles shall be plain, diagonal, or any other specified pattern.

10.8.3.4 Joints

The joints shall not exceed 1/32 inch in thickness. The mortar oozing out of the joints shall be wiped off immediately with damp cloth.

10.8.3.5 Thickness of Bedding Mortar

The floor shall be laid on ¾" thick bed of specified bedding mortar spread evenly on the base.

10.8.3.6 Laying of Tiles

- Over the base course (ground floor) or directly on the reinforced concrete (first floor) ¾" thick 1:2 cement mortar (1 of cement and 2 of sand) shall be evenly laid. The cement mortar shall be allowed to partially set before the floating coat consisting of liquid mixture of neat grey cement and water is poured on it. Each tile shall then be set individually over the floating coat and cement slurry will be worked up by tapping the tiles gently with a wooden mallet. The joints shall be as close as possible and edges should be rubbed down to get an exact size and thin joint. Joints shall be pointed with matching cement. Soon after this the tiles shall be washed and the surface shall then be dried by using a soft cloth.
- Laying the tiles should start from the center of the area so that the opposite sides will require the same number of tiles and so that the border design may work symmetrically.
- If the tiles have to be cut to the required size for the border, the edges of the tile shall be cut using electric cutter and evenly finished true and square by rubbing with carborandum stone or by any other approved means. The contractor will not be entitled to claim anything extra for cutting the tiles to the required size and finishing the edges as approved by the Engineer-in-charge. Tiles to be jointed at right angles shall have ends chamfered at 45°.

10.8.3.7 Protection

Flooring shall be allowed to mature undisturbed, and protected from the effects of weather. It shall be kept wet for at least 7 days after completion.

10.8.3.8 Surface

Surface shall be finished to specified levels. All joints shall be uniform, parallel and square.

10.8.4 Measurement

The measurement of tile flooring shall be by the superficial area. Its unit of rate shall be 100 ft² or m².

10.8.5 Rates**10.8.5.1 Labor Rate**

The unit rate shall include: -

- a. Watering and cleaning of base in case of ground floors and scrubbing and washing of the base slabs in case of upper floors.
- b. Laying of bedding mortar over the base.
- c. Laying of tiles in specified mortar over the bedding mortar.
- d. Protection and curing of the work.
- e. Cost of providing tools and plants required for carrying out the work in accordance with the above specifications.

10.8.5.2 Composite Rate

The unit rate shall include the cost of all the material supplied at site as specified above, in addition to the labour rate detailed in Heading 10.8.5.1 above.

10.9 Mosaic Tile Flooring

10.9.1 Description

Unless otherwise specified mosaic tile flooring shall be laid in accordance with the following specifications:

10.9.2 Materials

10.9.2.1 Ordinary Portland Cement

Ordinary Portland Cement shall conform to specification contained in Chapter-3 of Book-1(Specification for Engineering Material).

10.9.2.2 Fine Aggregate

Fine aggregate shall conform to Chapter-6 of Book-1(Specification for Engineering Material).

10.9.2.3 Coarse Aggregate

Coarse aggregate shall conform to Chapter-6 of Book-1(Specification for Engineering Material).

10.9.2.4 Water

Water shall conform to Chapter-2 of Book-2 of these specifications.

10.9.2.5 Marble Chips

Marble chips generally having size of 7 No. & 8 No., or approved size, colour, grade and quality shall be used.

10.9.3 Manufacturing of Tiles

10.9.3.1 General

In making these tiles the surface layer consists of some specially selected aggregate, usually crushed marble or granite or prepared aggregate, mixed in the proportion of 1 part of cement to 2 parts of aggregate. The facing aggregate should be well graded from ¼" to ½" maximum size down to material that will just be retained on a sieve having 8 meshes per linear inch. The facing material is mixed rather wet and the backing dry. The final finish is given by grinding the surface with sand on a wheel and polishing with carborandum wheels. It is important that the mould is always filled exactly to the same level and that the same pressure is applied to each tile. If this is not done, tiles of varying thicknesses will be produced and they will complicate the work of the tile layer. Various kinds of hardeners and admixtures are often used to give the tiles greater strength and harder wearing surface.

10.9.3.2 Workshop

It is essential that the manufacture of coloured cement floor tiles should be carried out in a well-constructed and properly ventilated building which should be free from draught and the direct rays of the sun. A plant with an output of 90 yds.², per day would require approximately 1500ft² area for manufacturing and stacking the freshly made tiles; 50' x 30' are good

dimensions. To that must be added the storing room for the finished tiles which should also be free from draught and direct light.

10.9.3.3 Curing

Curing has a very important bearing on the strength and soundness of concrete. Tiles should be completely immersed in water as soon as they are hard enough to be handled safely. (Generally, after 6 to 8 hours of moulding). With a thin product such as a tile, made with semi-dry concrete, it is practically certain that a very brief total immersion in water say of 12 hours, will cause the water to soak right through the tile. After this the tiles should be kept moist resting on their edges in racks for one week. It is safer to keep the tiles under cover for one week more before their curing is considered complete.

10.9.3.4 Grinding

Grinding the mosaic or inlaid tiles is done after thorough curing. Various types of machines are available for the purpose. Before polishing, the mosaic or inlaid tiles are levelled off on smoothing and levelling machine and are retouched with fluid binding cement. They are then placed in the recesses provided in the revolving table of the polishing machine. The polishing stone or block (generally a piece of carborandum) is held in a special holder and is kept in contact with the tiles by the application of light pressure by the workman; a jet of water continually plays on the revolving tiles. Polishing starts with a very coarse type of carborandum stone and finishes with the finest type to get a good polish.

10.9.3.5 Size

The common sizes of tiles are (i) 6"x6" (ii) 8"x8" (iii) 9"x9" and (iv) 12"x12". The 9"x9" and 12"x12" sizes are used primarily in large floor areas such as hotels and club lobbies and store rooms. The smaller sizes are used in bathrooms, kitchen floors and walls.

10.9.4 Construction Requirements

10.9.4.1 Base and its Preparation

For ground floor the base shall be laid as per Heading 10.5.3.

10.9.4.2 Cement Concrete Screed

Cement concrete screed of class A, shall be laid duly compacted on the base of floor.

10.9.4.3 Bedding Mortar

Tiles shall be laid over bedding cement sand ratio 1:3 mortar not more than $\frac{3}{4}$ " thick.

10.9.4.4 Joints

No joints shall be more than $\frac{1}{16}$ of an inch in thickness. Slabs projecting over the edges of verandahs or steps shall have their edges finished with a bull-nosed ending.

10.9.4.5 Laying

Tiles shall be laid in position on bedding mortar in specified pattern. The joints shall be filled with specified putty.

10.9.4.6 Levels

The surface of tiles when laid shall be perfectly true, level, projected or sloped.

10.9.4.7 Protection and Curing

The floor shall be protected from the effects of weather. During the progress of work and for 7 days after laying, the floor shall be kept watered. Three clear days shall be given for setting before anyone is allowed to walk over, but no weight shall be brought on the surface till 7 clear days have elapsed after the completion of laying.

10.9.5 Measurements

The measurement shall be done by the superficial area. The unit of measurement shall be 100 ft² or m².

10.9.6 Rate

10.9.6.1 Labor Rate

The unit rate shall include: -

- a. Washing, scrubbing and cleaning of base (in the case of ground floor).
- b. Laying of mosaic tiles and filling of joints with specified mortar including cutting of tiles if required.
- c. Coring and protection of work.
- d. Grinding & polishing.

10.9.6.2 Composite Rate

It includes the cost of all the materials supplied at site of work in addition to the labour rate detailed in Heading 10.9.6.1. This item, however, does not include the cost of cement concrete screed.

10.10 Conglomerate Flooring (Single Coat)

10.10.1 Description

Unless otherwise specified, the conglomerate flooring shall be laid in accordance with the following specifications.

10.10.2 Materials

- a. Cement Concrete Class-AI
- b. Cement concrete shall conform to the specifications contained in Chapter-6 of Book-2 of these specifications.

10.10.3 Construction Requirements

10.10.3.1 Base and its Preparation

Laying of floor base for ground floor shall conform to the Specification as contained in Heading 10.5.3.

10.10.3.2 Dividing into Panels

Before laying the concrete topping, the surface of the base shall be divided into symmetrical panels by glass or marble strips. Unless otherwise specified the area of individual panel shall not exceed 16 ft². Top of glass or marble strips shall be adjusted to the specified thickness of concrete topping and this level of the finished floor surface.

10.10.3.3 Finishing

The surface shall be levelled with a wooden trowel. Excessive troweling in the early stage shall be avoided. The surface shall be tested with a straight edge to detect undulations, which, if found, shall be eliminated. The finer stuff in the concrete which has come to the surface with the stroking shall be quickly but carefully smoothed with the steel trowel. When the concrete has hardened sufficiently, troweling shall be done with steel trowel. No dry cement or a mixture of dry cement with sand shall be sprinkled on the surface for hardening the surface.

10.10.3.4 Curing

The concrete topping shall be cured in accordance with specification contained in 6.10 "Curing Concrete" of Chapter-6 of Book-2.

10.10.4 Measurements

The conglomerate floor shall be measured by superficial area. The unit of measurement shall be 100 square ft² or m².

10.10.5 Rate

10.10.5.1 Labor Rate

The unit rate shall include: -

- a. Washing, scrubbing and cleaning of base at ground floor.

- b. Dividing into panels mixing, placing, compacting, finishing and curing of the topping concrete.
- c. Use of all related T&P for carrying out work in accordance with above specifications.

10.10.5.2 Composite Rate

It shall include cost of all the material supplied at site of work as specified above, in addition to the labour rate detailed in Heading 10.10.5.1 above.

10.11 Conglomerate Flooring (Two Coat)

10.11.1 Description

Unless otherwise specified, the conglomerate flooring (two coat work) shall be laid in accordance with the Specifications contained in Heading 10.10 for Conglomerate floor (single coat) except with the following modifications: -

- a. It shall be laid in two layers with a top layer half an inch thick, wearing surface composed of aggregate ($\frac{1}{4}$ " to $\frac{3}{16}$ ") crushed stone and cement conforming to Specifications contained in Heading 10.12 and a bottom layer of specified thickness.
- b. Unless otherwise specified, the cement concrete for the bottom layer shall be composed of one cubic foot of cement, 3ft^3 of fine aggregate and 6 cubic feet of coarse aggregate by volume.
- c. Unless otherwise specified, the surface layer shall compose of one part of cement and two parts of ($\frac{1}{4}$ " to $\frac{3}{16}$ ") crushed stone aggregate by volume.
- d. The bottom layer shall be brought to a level so that top layer shall have a minimum thickness of half an inch. The bottom layer shall be thoroughly compacted by tamping but shall not be finished smooth. While the bottom layer is still plastic, the top layer shall be placed over it and levelled with a steel float after light tapping for five minutes.

10.11.2 All Other Respects

In all other respect the work shall comply with Heading 10.10 of these specifications.

10.11.3 Measurements

The conglomerate floor shall be measured by superficial area. The unit of measurement shall be 100ft^2 or m^2 .

10.11.4 Rate

10.11.4.1 Labor Rate

The unit rate shall include: -

- a. Washing, scrubbing and cleaning of base at ground floor.
- b. Dividing into panels mixing, placing, compacting, finishing and curing of the topping concrete.
- c. Use of all related T&P for carrying out work in accordance with above specifications.

10.11.4.2 Composite Rate

It shall include cost of all the material supplied at site of work as specified above, in addition to the labour rate detailed in Heading 10.11.4.1 above.

10.12 Terrazzo/ Mosaic Flooring

10.12.1 Description

Unless otherwise specified, terrazzo floor shall be laid in accordance with the following specifications.

10.12.2 Materials

- a. Marble chips shall be of the approved grade, colour, size and quality.
- b. Cement shall conform to Chapter-3 of Book-1(Specification for Engineering Material). For laying terrazzo floor. Pigment of specified colour shall be mixed in white cement wherever required. Quantity of pigment shall, however, not exceed 12% of the weight of cement.
- c. Fine aggregate shall conform to the Specifications contain in Chapter-6 of Book-1(Specification for Engineering Material).
- d. Course aggregate shall conform to the Specifications contain in Chapter-6 of Book-1(Specification for Engineering Material).
- e. Water shall conform to the specifications contain in Chapter-2 of Book-1(Specification for Engineering Material).

10.12.3 Construction Requirement

10.12.3.1 Base

The base shall be laid in accordance with the Heading 10.5.3.

10.12.3.2 Proportion

Unless otherwise specified, the cement concrete used for bottom layer shall be of Class- 'A', conforming to the Specifications contained in Chapter-6 for Cement Concrete of Book-2. The Terrazzo topping shall consist of 2 parts of marble chips and one part of cement by volume.

10.12.3.3 Thickness

The topping shall not be less than $\frac{3}{8}$ of an inch thick and shall be laid mono lithic with the bottom layer of cement concrete (Class 'A1') of specified thickness. The total thickness of the topping and cement concrete shall not be less than $1\frac{3}{8}$ inches.

10.12.3.4 Bottom Layer of Concrete

The bottom layer of concrete shall not be smooth finished but shall have a rough surface so that it shall be well bonded with the Terrazzo topping.

10.12.3.5 Preparing Surface of Bottom Concrete

Before laying Terrazzo topping the surface of bottom layer of concrete shall be cleaned. It shall be free from dust, plaster or other foreign matters.

10.12.3.6 Dividing into Panels

Unless, otherwise, mentioned the area of individual panel shall not exceed 16ft² for paneling the floor, dividing strips of glass marble, brass, copper, stain-less steel specified thickness

should be used. Dividing strips shall be to the full depth of topping. The strips shall be added in a manner that their tops are in level with the required finished surface of the floor.

10.12.3.7 Laying

The top course shall be laid over the bottom course of concrete within 36 hours after the bottom course of concrete has been laid. If laying of top course is delayed by more than the specified time, a slurry of neat cement shall be brushed on to it immediately before the topping is laid. The terrazzo mix shall be placed on the bottom concrete and compacted by tamping.

10.12.3.8 Curing

After laying the top course, the surface shall be covered with damp hessian cloth and every precaution shall be taken to prevent its being subjected to the effects of weather. The flooring shall be maintained in a damp condition till it is fit for grinding.

10.12.3.9 Face Grinding

The grinding of terrazzo shall commence 3 days after laying is completed.

- a. The first grinding shall be done with an approved coarse abrasive (carborundum blocks or disc) by sprinkling fine sand over the surface and by using an ample quantity of water to assist the grinding. The flooring shall be washed clean with plenty of water till trace of ground slurry is removed and marble chips are visible.
- b. All holes or open pores shall be made good with neat cement, the grout being well worked into the surface by rubbing with a stone and finishing of a little above the level of the finished surface of floor. The portion so treated shall be kept damp till the floor is ready for the second grinding.
- c. The second grinding shall be done after about 5 days using an approved medium graded coarse abrasive (carborundum blocks or disc), and pores, if any, shall be treated similarly as after the first grinding.
- d. The final grinding shall be done with an approved fine graded carborundum stone and the surface thoroughly washed down with water.

10.12.3.10 Finishing

After final grinding the floor shall be thoroughly washed. Tartaric Acid or powder oxalic acid shall be sprinkled over the floor and rubbed with gunny bags wrapped round rods. The floor shall be allowed to dry and then more oxalic or tartaric acid shall be rubbed with cloth pads. When floor is completely dry, the final gloss shall be given by an approved wax polish.

10.12.3.11 Terrazzo Dado & Skirting

The plastered surface over which the dado/skirting is to be applied shall be well roughened and watered, cement mortar of specified ratio shall then be plastered over this well roughened surface to the indicated thickness. Before the base course has set the layer of mosaic mixture shall be well troweled into the surface of the base to a thickness which after grinding shall result in the finished thickness. A layer of neat cement of the specified color shall then be well troweled into the surface leaving a plain smooth surface. The Contractor shall start finishing as specified for floors above. Mosaic skirting shall be provided around all mosaic floors unless shown otherwise. Skirting and dado shall be straight, level and in plumb. Intersections at floors shall be straight and flush.

10.12.4 Measurement

The terrazzo floor shall be measured by the superficial area. Its unit of measurement shall be 100 ft² or m².

10.12.5 Rates

10.12.5.1 Labor Rate

The unit rate shall include: -

- a. Preparing surface of bottom concrete.
- b. Dividing into panels, mixing, pouring, curing, surface grinding, final finishing and polishing.
- c. Providing, using tools and plants for carrying out work in accordance with the above specifications including POL and electricity consumption charges.

10.12.5.2 Composite Rate

The unit rate shall include the cost of all materials supplied at the site of work as per above specifications, in addition to the labour rate as detailed in Heading 10.12.5.1.

10.13 Dry Brick Paving

10.13.1 Description

Unless otherwise specified dry brick, paving shall be done in accordance with the following specifications.

10.13.2 Materials

- a. Bricks shall conform to Chapter-3 of Book-1(Specification for Engineering Material) for clay bricks.
- b. Sand shall conform to Chapter-6 of Book-1(Specification for Engineering Material) for Fine Aggregate.
- c. Mud mortar shall conform to Chapter-5 of Book-2 of these specifications for Mud Mortar.

10.13.3 Preparing Surface

The ground surface shall be thoroughly watered, well rammed and shall be dressed to the specified slope, camber or cross grade.

10.13.4 Laying

Bricks shall be laid dry, on edge or flat in the specified pattern over ½-inch thick mud plaster given on the surface. The joints shall not exceed one quarter of an inch in thickness. After laying the bricks the joints shall be sand grouted.

10.13.5 Measurement

The measurement of dry brick paving shall be by the superficial area. Its unit of measurement shall be ft³ or m³.

10.13.6 Rates

10.13.6.1 Labor Rate

It shall include: -

- i. Preparation of surface.
- ii. Laying of mud plaster.
- iii. Laying of bricks on mud plaster and grouting with sand.
- iv. Use of all the tools and plants required to carry out work according to the above specifications.
- v. Sweeping away all surplus sand and cleaning away all debris or broken bricks.

10.13.6.2 Composite Rate

The unit rate shall include the cost of brick, mortar and sand supplied at site of work, in addition to the labour rate detailed in Heading 10.13.6.1.

10.14 Wooden Flooring

10.14.1 Description

Wooden floor shall be either hollow floor with planking of required size and thickness fixed on floor bearer frames or wooden block flooring fixed on concrete bed by bituminous adhesive. All timber shall conform to Specification contained in Chapter-12 of book-1 (Specification for Engineering Material) and shall be of specified species.

10.14.2 Floor Bearers: Ground Floors

In the case of upper floors, the bridging joists shall rest on wall plates, beams, rails or on other joists as shown on the drawings, or otherwise directed by the Engineer-in-charge.

10.14.3 Floor Bearers: Suspended Floors

In case of upper floors, the bridging joists shall rest on wall plates, beams, rails or on other joists as shown on the drawings, or otherwise directed by the Engineer-in-charge.

10.14.4 Floor Bearers Material and Fixing

In case of upper floors, the bridging joists shall rest on wall plates, beams, rails or on other joists as shown on the drawings, or otherwise directed by the Engineer-in-charge.

10.14.5 Boarding Material and Size

The boarding for the floor shall not be planned on the underside in the case of ground floors and suspended floors to be coiled. Unless otherwise specified or shown the drawings, in the case of deodar, kail or chir wood, the boards or battens shall not be thicker than 1½ inches thick, not more than 6 inches wide and not more than 20 feet long. In the case of teak, they shall be 1 inch thick, 4 inches wide and as long as possible. No board shall be less than 6 feet long, the ends being truly squared up after any split portion has been sawn off. All boards shall be uniform and parallel in width and shall have the same thickness.

10.14.6 Preservative

All joists, wall plates, bearers, and the underside of planking shall be given two coats of hot wood preservative such as solignum, creosote, or coal tar, as directed by the Engineer-in-charge.

10.14.7 Joints

The planks shall be planed true on one side (on both sides for uncoiled upper floors), the edges to be planed, rebated or tongued and grooved as directed by the Engineer-in-charge. Unless otherwise specified, the edges shall be tongued and grooved, with concealed joints for teak wood floors, and rebated joints for other floors.

10.14.8 Planking, Method of Laying

The outer lines of boarding shall be accurately fixed paralleled with and close to the wall. Each subsequent line shall have the side joints carefully joined up and shall then be cramped into position by floor cramps, and nailed or screwed as specified, so that the heads shall be sunk below the finished surface of floor, or otherwise fixed with "secret joints". The cramps shall not be removed until the nails or screws have been fixed. The ends of plank shall rest on the center of joist, and the ends of no two adjacent planks shall be on the same joist. Paved floors shall be stopped under a brass strip screwed to wooden floors where the two meet.

10.14.9 Nails and Screws

The nails or screws shall be subject to the approval of the Engineer-in-charge and shall have a length at least twice the thickness of the plank, two being used at each end and one at every intermediate joist alternately on opposite sides of the plank. All screws shall be oiled before insertion.

10.14.10 Planning

After the floor has been laid, it shall be planned in both directions and made perfectly smooth. All depressions in the wood, nail holes and all small defects of every kind, where permitted by the Engineer-in-charge to remain in the work, shall unless otherwise specified, be filled with "Beaumontage" or wax used for stopping/filling holes or other defects.

10.14.11 Measurement

The measurements of wood flooring shall be done by the superficial area. The unit of measurement shall be ft² or m².

10.14.12 Rate

The unit rate shall include the floor boarding laid and fixed in position and planned in both directions, provision of brass screws in the case of teak wood floor where concealed fixing is not employed. Works like sand papering, oiling, waxing, staining or varnishing are not covered and shall be paid for separately. The unit rate does not include joists, wall plates, bearers, beams, rolled steel joists, rails, concrete or masonry pillars. Payment for these shall be made separately.

10.15 Rubber Flooring

10.15.1 Scope

Rubber flooring shall include rubber floorings, either plain or marbled, in sheet or tile form and shall be composed of vulcanized rubber compounds. This flooring may be provided in important buildings, important offices, hospitals, cinemas, hotels, restaurants, etc.

10.15.2 Materials

Rubber tiles shall be satisfactorily vulcanized, free from sulphur bloom, porosity and grit. The wearing surface shall be smooth, plain and the colour of the flooring shall not be noticeably affected by washing with water or with suitable cleansing material such as good quality soap or by treatment with a suitable floor polish. The standard thickness of the rubber flooring shall range from 1/8 inch to 1/2 inch. Rubber tiles shall comply with standard hardness, accelerated ageing, compression set and water absorption tests contained in the relevant British Standard Specifications No. 1711: 1951.

10.15.3 Composition

The flooring shall be made from good quality new raw natural rubber in conjunction with other suitable compounding ingredients. The finished flooring shall contain not less than 35% by volume of good quality new raw natural rubber.

10.15.4 Base

Cement concrete or any other solid and hard surface shall form the base for rubber flooring. The surface of the base shall be thoroughly clean, and free from contamination of dust, moisture oil or grease. Any irregularity on the base shall be filled in and leveled off before laying the tiles.

10.15.5 Laying

The base shall be prepared as specified under base. While laying the rubber tiles, areas not exceeding 25 ft² at a time shall be coated with the approved adhesive material. Sufficient number of tiles for this area shall be first roughened at their bottom surface and all sides, and then treated with the adhesive material. 10 to 15 minutes shall be spent waiting after this, for exposing the coated surface to the air before fixing the tile in true position on the base. After laying the tiles, pressure shall be applied from the upper surface of the tile, to remove any air that may have been trapped in between the bounded surfaces. This shall be done with the help of a small hand steel roller or by an approved method. The finished surface shall be washed with soap and water after three days.

10.15.6 Curing

No load shall be applied in rubber tiles within three days of its laying.

10.15.7 Measurement

The unit of measurements shall be 100 ft² of the paved area.

10.15.8 Rate

Rate shall include the cost of rubber tiles, adhesive mixtures, and all labour required for preparing the base and laying the rubber tiles as specified above.

10.16 Laminate Flooring

Laminate Flooring is considered a “floating” floor and is installed using a floating floor system. These floors are intended for indoor use only and can be installed over virtually any existing floor structure. Since these floors are composed of natural cellulose fibres, they will expand and contract with changes in relative humidity.

10.16.1 Sub Floors Requirements for Laminate Flooring

1. For concrete floors

It must be cured properly and allowed to dry as per instruction of Engineer-in-Charge and must be free from alkali elements. Moreover, it must be proper levelled to avoid the kinks in the laminate flooring.

2. Wood subfloors must be suspended and have a minimum of 18” (45.7 cm) of well-ventilated crawl space.

Regardless of grade level, do not install over wood subfloors applied directly to concrete or on sleepers over concrete. Installation of a polyethylene film vapour barrier such as Armstrong Moisture Barrier Sheeting over the ground in the crawl space is recommended. The polyethylene film acts as a moisture barrier when seams are taped together with polyethylene tape.

3. Preparatory Work for Laminate Flooring

Following points should be kept in view while the preparatory work for laminate flooring in progress: -

- Removal of existing wall base, millwork, or trim is optional.
- Door trims and doorjamb must be undercut to allow the floor to move freely. Use discarded piece of floor and foam underlayment to support the saw blade at the correct height for undercutting.
- Sweep the subfloor and remove all dust and debris.
- If the drywall (plaster board, wallboard, gypsum panel, or gypsum board) is slightly elevated at the floor and wall juncture, create a solid wall surface by fastening a 2” to 3” (5 cm to 7.6 cm) wide facing strip such as ¼” (6.35 mm) plywood to the wall at the stud location.
- New wall base or moulding must be installed at the end of the job to cover the ¼” (6.35 mm) to ½” (12.7 mm) expansion zone around the perimeter of the floor.
- It may be necessary to plane or cut the bottom of the door to accommodate the change in floor height.
- While in layout of laminate floor special care must be taken for the natural light, layout must be done to the incoming light from any windows, if natural light not provided in the room layout must be done to the longest side of the room.
- The floors must be moist free, if some dampness is observed, then dry the dampness first.
- If the cabinets exist in the flooring, then the laminate around the cabinets leaving ¼” (6.35mm) to ½” (12.7mm) expansion zone.
- If installing cabinets after the laminate has been installed, most or all of the cabinet weight should be supported by the wall mountings. To secure the cabinets to the

substrate with screws or nails, drill holes through the laminate 1/2" (12.7 mm) diameter larger than the screw or nail to allow for expansion.

- Always check each laminate flooring panel for damage before installing.

4. Installation Method

- Avoid narrow pieces at the finish wall. Measure the distance between the starting wall and the finish wall.
- Divide this number by the width of the board.
- If the remainder is less than 2-1/2" (6.35 cm), cut off 2-1/2" (6.35 cm) from the width of the first row or to balance the room add the difference to the plank width and divide by two.
- Roll out the moisture control sheeting as per recommendation of manufacturer or as per instructions of Engineer-in-Charge then install the laminate flooring.

10.16.2 Measurement

Length and breadth shall be measured correct to a cm before laying skirting, dado or wall plaster and the area calculated in square meter correct to two places of decimal. Where coves are used at the junctions, the length and breadth shall be measured between the lower edges of the covers.

No deduction shall be made nor extra paid for voids not exceeding 0.20 square meter. Deductions for ends of dissimilar materials or other articles embedded shall not be made for areas not exceeding 0.10 square meter.

10.17 Asphalt Flooring

10.17.1 Scope

The work shall include furnishing all labour, materials, equipment's, plants, instruments, accessories and services necessary to complete the work at the locations shown on the drawings or as directed by Engineer-in-charge in accordance with these specifications.

10.17.2 Materials

- Asphalt used in constructing the asphalt flooring shall be in complete conformity with the applicable requirements set forth in the specifications for asphalt or as approved by Engineer-in-charge.
- Bitumen used for mixing with the asphalt shall be refined cut-back bitumen having viscosity (Standard Tar Viscometer) of 110 to 150 seconds at 40 degree centigrade or as approved.

10.17.3 Base

The base should be prepared in conformity with specification 10.4 'Base for Flooring'.

10.17.4 Laying

Asphalt flooring shall be done in accordance with the details shown on the drawings, the Engineer-in-charge instructions and the stipulations and requirements set forth herein as

under. All dust and sand shall be swept-off, and the asphalt having been mixed and melted in the following proportions, unless otherwise specified or as directed by Engineer-in-charge.

- Asphalt 1 part
- Bitumen 1/32 part
- Clean sharp sand ½ parts

Shall be laid on smoothly and evenly of uniform thickness as specified and carefully and steadily rubbed with hand float until the surface shall be perfectly even and true.

10.17.5 Finishing

The junction of the sections of the asphaltting shall be carefully made, and before the surface becomes hard, it shall be worked perfectly level and smooth with fine clean sand and left of a uniformly dark colour.

10.17.6 Measurement

- Length and breadth shall be measured correct to a cm before laying skirting, dado or wall plaster and the area calculated in square meter correct to two places of decimal. Where coves are used at the junctions, the length and breadth shall be measured between the lower edges of the coves.
- No deduction shall be made nor extra paid for voids not exceeding 0.20 square meter. Deductions for ends of dissimilar materials or other articles embedded shall not be made for areas not exceeding 0.10 square meter.

10.18 Muram Flooring

10.18.1 Scope

The work shall include furnishing all labour, materials, equipment, and performing all operations specified herein to lay the murum floors in accordance with the drawings, or as directed by Engineer-in-charge.

10.18.2 Materials

- All murum used in construction murum flooring shall be in complete conformity with the applicable requirements set forth in this section.
- Rubble or broken bricks

10.18.3 Preparing Surface

All filling up-to 30 cm below the proposed floor level shall be dug out and the hollow thus created shall be treated as specified hereunder.

10.18.4 Laying

All murum floors shall be constructed in accordance with the detail shown on drawings, the Engineer-in-charge's instructions and the stipulations and requirements set forth herein, as follows: -

- The dug-out surface as mentioned in 10.18.3 'Preparing Surface' shall be properly watered and rammed with hand rammers sufficiently to the entire satisfaction of Engineer-in-charge. The consolidated surface shall be such that a very faint impression can be made on it with the heel of boot or the blow of hammer.
- Sub-base of broken bricks or hand packed rubble shall be laid to a template evenly and watered thoroughly and allow to dry. The surface shall be fairly levelled and beaten with rammers to produce one uniform level. Up-to the entire satisfaction of the Engineer-in charge.
- Then a layer of good hard murum, 150 mm thick, shall be added and water thoroughly for 2 days. When the whole mass has become too slushy, it shall be tempered over by coolies so as to form a one uniform mass. Then the surface shall be fairly levelled and beaten with hand rammers, to one uniform level. It shall be then allowed for dry for 2 to 3 days.
- Finally, spread 25 mm layer of fine powder or flaky variety of murum, which shall be thoroughly beaten by hand rammers. As a check of good work, the surface shall not now crack on drying and the floor is complete.

10.18.5 Measurement

- Length and breadth shall be measured correct to a cm before laying skirting, dado or wall plaster and the area calculated in square meter correct to two places of decimal. Where coves are used at the junctions, the length and breadth shall be measured between the lower edges of the coves.
- No deduction shall be made nor extra paid for voids not exceeding 0.20 square meter. Deductions for ends of dissimilar materials or other articles embedded shall not be made for areas not exceeding 0.10 square meter.

10.19 PVC Tiles/Sheet Flooring

10.19.1 General

Such flooring shall consist of PVC flexible sheet or tile of the colour as per drawings or directed by the Engineer-in-Charge. It shall conform to the relevant Standards: -

- ASTM-D 2859 Flammability of finished materials vinyl-asbestos tile or flooring.
- ASTM-D 3564 Application of floor polishes to maintain vinyl- asbestos tile or flooring.
- BSS 3260 PVC (vinyl) asbestos floor tiles.
- BSS 3261 Unpacked flexible PVC flooring

10.19.2 Types of PVC Flooring/Tiles

PVC Tiles (Static): PVC tiles / sheet of requisite thickness shall be of best quality available in the Country. Size, colour, shade and adhesive shall be as per the sample which shall be submitted by the Contractor and approved by the Engineer.

PVC Tiles (Anti-static): PVC tiles / sheet of requisite thickness shall be of best quality available in the Country. Size, colour, shade, import quality copper strips and conductive adhesive shall be as per the sample which shall be submitted by the Contractor and approved by the Engineer.

Following shall be the technical requirements;

- For new floors between two dry contact electrodes no individual reading shall be greater than $5 \times 10^6 \Omega$ than $2 \times 10^4 \Omega$. The average of all readings shall remain between $2 \times 10^6 \Omega$ and $5 \times 10^4 \Omega$.
- For existing floors between two dry contact electrodes no individual reading shall be greater than $5 \times 10^7 \Omega$. The average of all readings shall be $2 \times 10^7 \Omega$.

10.19.3 Installation Method

10.19.3.1 PVC Static Flooring Sheets/Tiles

The base shall be prepared as per thickness shown on drawings keeping the margin of tile thickness. After the base is cured, any irregularities found on the base shall be filled in and levelled before the application of tiles. Surface to receive tiles shall be thoroughly cleaned of all dirt, dust, oil and other objectionable matter. Approved manufacturer's recommended adhesive shall be applied as per specifications and in quantities recommended by him. Tiles/sheets shall be laid starting from one side of the room or as per the instructions of the Engineer and shall be so pressed that complete adhesion takes place. Tiles/sheet shall be cut where required with suitable cutting tool and rough edges shall be rubbed smooth. Tiles shall be laid to straight edges as per approved pattern.

10.19.3.2 PVC Anti-Static Flooring Sheets / Tiles

1. Preparation of Base

The base shall be prepared as per thickness shown on drawings keeping the margin of tile thickness and network of Copper Strips. After the base is cured, any irregularities found on the base shall be filled in and levelled before the application of sheets/ tiles. Surface to receive tiles / sheets shall be thoroughly cleaned-off all dirt, dust, oil and other objectionable matter. Approved manufacturer's recommended adhesive shall be applied as per specifications and in quantities recommended by him. Tiles/sheets shall be laid starting from one side of the room or as per the instructions of the Engineer and shall be so pressed that complete adhesion is ensured. Tiles/sheets shall be cut where required with suitable cutting tool and rough edges shall be rubbed smooth. Tiles shall be laid to straight edges as per approved pattern.

2. Fitting the Copper Mesh

Lay the full lengths of copper strips across the room on both sides cutting each other. Each strip must be at a distance of 12" from each other and 24" from the other. The joints of these sheets must be properly acid welded. Keep as many points of the copper strip as you require out from the ends for earthing purpose. Similarly, the whole copper grid must be properly earthed. To do so one part of this grid shall be attached to the earthing point of the room. The non-static tiles shall then be laid on the floor. This grid shall only be necessary for assuring the continuity. The strip shall pass beneath of the tile to give proper resistance.

3. Fixing PVC Floor Tiles / Sheets (Anti-Static)

- Mark out the room area with chalk lines across length and width, positioned to allow for reasonably sized tile cuts on all sides.
- The new trowel blade enclosed with the adhesive shall be fitted when starting the pack and used for spreading one pack only.
- Stir the adhesive before use.
- Spread the adhesive evenly holding the blade at an angle of about 60 degrees.
- Good transfer is essential; the area spread with adhesive at any time shall be limited to ensure that all the tiles and cuts can be laid while the adhesive is still wet. Commence tiles laying at the point first spread so that the adhesive has been left open for approximately 15 minutes. The actual area spread and the open time shall depend on the absorbency of the sub-floor and ambient conditions. Do not spread more than one pack at a time.
- Ensure electrical conductivity by overlapping adjacent areas of adhesive application.
- Put tiles closely and press them firmly to the floor to give good contact over the whole tile area.
- Approximately 1-hour after laying the tiles apply suitable pressure on them to ensure overall good contact. Care shall be taken that adhesive shall not squeeze up between the tiles, and if it happens then immediate cleaning of it shall be necessary.
- Dried adhesive residue shall be removed with a slightly abrasive cloth.

4. Traffic

Electrical testing shall be carried out until at least 21-hours after completing the installation. The method shall be as laid down or as specified. The following summarizes the procedure recommended in NHS technical memorandum No. 2 (1977)

5. Equipment

An insulation testing ohm meter having an approximate open circuit voltage of 500 volts DC and capable of measuring resistance values of between 10^4 and $5 \times 10^7 \Omega$.

6. Method

The finished surface of concrete screed as floor base shall be washed thoroughly and then be allowed to dry (no test shall be carried out within 2-hours of floor being wetted) with subsequent wiping over it with a dry cloth. Place the electrodes approximately 12" apart and measure the resistance between them. In order to check the actual resistance, the black bottom layer shall have to be checked, to do this either puncture a tiny hole on the surface of the tile or check the resistance from the left out copper strips on the ends of the floor.

10.20 Glass Flooring

Glass flooring is not very common, but can be used in aristocratic buildings both residential and public particularly to have smooth and pleasing surface. Glass flooring is generally bacteria and dirt-resistant.

10.20.1 Laminated Glass Floors

There are many types of laminated glass now available commercially for use in glass floors, but broadly they fall into two categories: -

- PVB laminated Glass
- Cast in place resin-bonded glass

For most large commercial applications, the PVB laminate system is usually most appropriate on cost and safety grounds. For small applications or for those using highly specialized and/or highly textured materials where artistic effect and not cost is the over-riding concern the resin-bonded system shall be more appropriate.

10.20.1.1 PVB Laminated Glass

This is a safety glass made by an industrial heat and pressure process that laminates two or more sheets of glass with a continuous flexible interlayer of plasticized PVB sheeting between them. Typically for most glass flooring uses the interlayers shall be 0.76mm thick but in heavy duty products 1.52mm interlayers shall be used.

10.20.1.2 Cast in Place resin-bonded Glass

This safety glass is typically made by pouring a vinyl ester resin mixture into the cavity between two sheets of glass. Whilst still fluid, any air in the resin mix should be expelled and left to cure. Other resin mixes such as aliphatic urethanes should be used in this method and these should use other curing regimes such as UV light and the use of accelerators. The layer of resin shall be usually between 0.8mm to 2 mm thick and is typically contained by the use of a 6mm clear edge tape around the perimeter edge.

10.20.2 Installation Requirements for Laminated Glass Flooring

- Laminated glass floors need a rigid flat support with a maximum deflection of L/500.
- Minimum support depths should be 20-30mm, and can be either two-sided or four sided.
- Adjustable pedestal support can also be employed such as those used in the external glass bridges at Computer Associates in Slough.
- Joints should be no less than 4mm, and typically joints 6mm wide are used. The glass is installed onto continuous silicone strips of 60-80° shore hardness both beneath the glass and between the glass and adjoining surfaces. A hard wearing two-part polysulphide mix such as Arbocol 1050 is used to seal the top of the glass. Once bedded down onto silicone pads the dead weight of the panels is usually enough to prevent movement. For smaller panels or for panels not jointed at the edges, panels can be fixed mechanically or with structural silicone.

10.21 Skirting and dado

- The plastered surface over which the dado/skirting is to be applied shall be well roughened and watered, cement mortar of specified ratio shall then be plastered over this well roughened surface to the indicated thickness. Before the base course has set the layer of mosaic mixture shall be well troweled into the surface of the base to a thickness which after grinding shall result in the finished thickness. A layer of neat cement of the specified color shall then be well troweled into the surface leaving a plain smooth surface. The Contractor shall start finishing as specified for floors above. Mosaic skirting shall be provided around all mosaic floors unless shown otherwise or directed by Engineer in charge. Skirting and dado shall be straight, level and in plumb. Intersections at floors shall be straight and flush.
- Tile skirting, where required, shall be fixed only after laying the tiles on the floor. If tiles are to be fixed on walls as dado, the portion of the wall to be so tiled shall be left unplastered. Also, dado work shall be done only after laying tiles on the floor.
- Before fixing tiles on brick or concrete wall, the wall surface shall first be wetted with clean water. Thereafter, in case of dado the wall surface shall be evenly and uniformly covered with about 10 mm thick backing of cement mortar (1 cement:4 coarse sand). In the case of skirting, the tiles shall be directly fixed with cement mortar (1:4) without initial backing. Before the cushioning mortar has hardened, the back of each tile to be fixed shall be covered with a thin layer of neat cement paste and the tile shall then be gently tapped against the wall with a wooden mallet. The fixing shall be done from the bottom of the wall upwards. Each tile shall be fixed as close as possible to the one adjoining, and any difference in the thickness of the tiles shall be evened out in the cushioning mortar or cement paste so that all the tile faces are set in conformity with one another.
- Wherever possible, skirting and dado shall be ground and polished just as for Boor work with machine suitable for the purpose. Skirting and dado may also be polished by hand.
- Contractor will be responsible for the replacement of work non-confirmatory to the client requirement mentioned in contract documents and no extra payment shall be paid to the contractor for this replacement.

10.22 Porcelain Tile Flooring

10.22.1 Description

The tiles shall be of approved make. These will be of porcelain tiles with one face glazed and shall be white or colored as specified in the schedule of quantities. The thickness used shall be ¼" or 3/8" as specified.

Unless otherwise specified, tile flooring shall be laid in accordance with the following specifications.

10.22.2 Materials

- Porcelain tiles of approved make and size as directed by Engineer in charge or specified in BOQ.
- 1:2 cement sand mortar of thickness not less than 3/4 inch.
- Tile spacers of approved make and quality and as approved by Engineer in charge.

10.22.3 Construction Requirement

10.22.3.1 Base and Its Preparation

For ground floor the base shall be laid as per specifications contained in Heading 10.4 The base 1st floor and subsequent floors shall be prepared in accordance with Heading 10.5.3.1.1.

10.22.3.2 Wetting of Tiles

If using Portland cement then tiles shall be wetted in water for 12 hours before they are laid in position. If using

10.22.3.3 Pattern

The laying of tiles shall be plain, diagonal, or any other specified pattern.

10.22.3.4 Joints

The joints shall not exceed 1/32 inch in thickness. The mortar oozing out of the joints shall be wiped off immediately with damp cloth.

10.22.3.5 Thickness of Bedding Mortar

The floor shall be laid on ¾" thick bed or any other approved thickness of specified bedding mortar spread evenly on the base.

10.22.3.6 Laying of Tiles

- Over the base course (ground floor) or directly on the reinforced concrete (first floor) ¾" thick 1:2 cement mortar (1 of cement and 2 of sand) shall be evenly laid. The cement mortar shall be allowed to partially set before the floating coat consisting of liquid mixture of neat grey cement and water is poured on it. Each tile shall then be set individually over the floating coat and cement slurry will be worked up by tapping the tiles gently with a wooden mallet. The joints shall be as close as possible and edges should be rubbed down to get an exact size and thin joint. Joints shall be pointed with matching cement. Soon after this the tiles shall be washed and the surface shall then be dried by using a soft cloth.

- Laying the tiles should start from the center of the area so that the opposite sides will require the same number of tiles and so that the border design may work symmetrically.
- If the tiles have to be cut to the required size for the border, the edges of the tile shall be cut using electric cutter and evenly finished true and square by rubbing with carborandum stone or by any other approved means. The contractor will not be entitled to claim anything extra for cutting the tiles to the required size and finishing the edges as approved by the Engineer-in-charge. Tiles to be jointed at right angles shall have ends chamfered at 45°.
- For symmetrical laying of tile it should be necessary to use spacer between tiles

10.22.3.7 Protection

Flooring shall be allowed to mature undisturbed, and protected from the effects of weather. It shall be kept wet for at least 7 days after completion.

10.22.3.8 Surface

Surface shall be finished to specified levels. All joints shall be uniform, parallel and square.

10.22.4 Measurement

The measurement of tile flooring shall be by the superficial area. Its unit of measure should be square feet.

10.22.5 Rates

10.22.5.1 Labor Rate

The unit rate shall include: -

- f. Watering and cleaning of base in case of ground floors and scrubbing and washing of the base slabs in case of upper floors.
- g. Laying of bedding mortar over the base.
- h. Laying of tiles in specified mortar over the bedding mortar.
- i. Protection and curing of the work.
- j. Cost of providing tools and plants required for carrying out the work in accordance with the above specifications.

10.22.5.2 Composite Rate

The unit rate shall include the cost of all the material supplied at site as specified above, in addition to the labour rate detailed in Heading 10.21.5.1 above.

10.23 Granite Flooring

10.23.1 Description

This item of work will include laying of granite tiles as per specifications. Unless otherwise specified granite flooring shall be constructed in accordance with the following specifications.

10.23.2 Material

10.23.2.1 Granite Tiles

Granite tiles shall be of the size, type and colour as specified in BOQ. All tiles shall have a true plain surface and shall be accurately swan, truly square at edges to the full thickness.

10.23.2.2 Portland Cement Concrete

Portland cement concrete screed 1" thick of nominal maximum 1:2:4.

10.23.2.3 Mortar

Cement sand mortar ratio 1:3 conforming to the specification as contained in Chapter-5 of these specifications.

10.23.3 Construction Requirements

10.23.3.1 Preparation of Base

The base shall be laid in accordance with the Heading 10.4. Before laying of granite tiles, the surface of the base shall be washed and scrubbed with wire brushes.

10.23.3.2 P.C.C. Screed

P.C.C. Screed 1" thick will be laid on this base.

10.23.3.3 Bedding Mortar

Marble stone slabs shall be laid over bedding mortar not more than $\frac{3}{4}$ " thick.

10.23.3.4 Joints

No joints shall be more than 1/16 of an inch in thickness. Slabs projecting over the edges of verandah or steps shall have their edges finished with a bull-nosed ending.

10.23.3.5 Laying

Slabs shall be laid in position on bedding mortar in specified pattern using the plastic spacers. The joints shall be filled with specified putty.

10.23.3.6 Levels

The surface of granite tiles when laid shall be perfectly true, level, projected or sloped.

10.23.3.7 Protection and Curing

The floor shall be protected from the effects of weather. During the progress of work and for 10 days after laying, the floor shall be kept watered. Three clear days shall be given for setting before anyone is allowed to walk over, but no weight shall be brought on the surface till 7 clear days have elapsed after the completion of laying.

10.23.3.8 Grouting & Sealing

If contractor used tile spacers in between tiles, or if the distance between them is less than 1/8 inch, then contractor should use grout. As grout spread over the tile, apply pressure to force the grout into the gaps. Wipe out excess grout before it hardens. Wait for the grout to cure for 3 days before cleaning the tiles with sponge and warm water. This will clear floor of any remaining debris and residue. After that, apply approved quality grout sealer to ensure that the joints are also protected from water and stains.

10.23.3.9 Grinding

After the granite has hardened enough, it shall be ground with an approved type of grinding machine with rapid cutting carborundum stones. The floors shall be kept wet during the grinding process. All materials ground off shall be removed by sweeping and flushing with water. Then the floor surface shall receive a second grinding followed by final grinding to remove the film of cement paste and to give the floor a polish. It shall then be thoroughly washed and all surplus material removed.

10.23.3.10 Polishing & Finishing

The surface after grinding will be left undisturbed for a period of one week. After this period the surface shall be cleaned of dirt and dust by rubbing gently with pumice stone using sufficient water. If the surface has somehow been dirtied it must be washed with washing soda. Then the surface will be cleaned and rubbed hard with Oxalic acid (1:10 solution) using felt or an old blanket. Thereafter the surface shall be cleaned and washed with plenty of water. After the surface has dried it will be finished to the satisfaction of the Engineer-in-charge with wax polish by using polishing machine.

10.23.4 Measurements

The measurement of granite flooring shall be done by the superficial area. The unit of measurement shall be 100 ft².

10.23.5 Rates

10.23.5.1 Labor Rate

The unit rate shall include: -

- a. Washing, scrubbing and cleaning of base (in the case of ground floor).
- b. Laying of bedding mortar.
- c. Laying of granite over bedding mortar and RCC screed.
- d. Filling of joints with white/grey cement with matching pigment.
- e. Levelling, curing, grinding & polishing of marble slabs as per these specifications.
- f. Use of all the tools and plants required for carrying out work in accordance with these specifications.

10.23.5.2 Composite Rate

It includes the cost of all the materials supplied at site of work as per these specifications, in addition to the labour rate detailed in Heading 10.23.5.1.

10.24 Polyurethane Floor System

10.24.1 Scope

- A. The complete installation of polyurethane surfacing over high performance resilient base mat, by contractor, including adhesives, resilient base mat, polyurethane sealer, polyurethane structure layer, surface topcoat, and court markings.
- B. Related work specified under other sections.
 1. Preparation of Base for flooring as heading 10.4 of these specifications
 2. Laying concrete slab with depression of 9mm.
 3. **Waterproofing and Dampproof course:** Concrete subfloors on or below grade shall be adequately waterproofed beneath the slab and at the perimeter walls and on the earth side of below grade walls by general contractor using suitable type membrane.

10.24.2 Material Requirement

- Pulastic Bronze Line 90:
- **Adhesive:** Pulastic Tacky Adhesive: a two-component polyurethane adhesive
- **Shock Pad:** Academy Shock Pad, a granulated rubber/polyurethane mat 7.0 mm thick.
- **Pad Sealer:** Pulastic EG Sealer: a two-component polyurethane sealer
- **Polyurethane Resin:** Pulastic GM1500 Compound: a pigmented two-component polyurethane resin
- **Surface Coating:** Pulastic Coating Multi-Coat: a pigmented, two-component, water-dispersed polyurethane surface coating.
 - Color Options: Specify Topcoat color from following standard colors:
 1. 205 Sand Beige
 2. 504 Stone Grey
 3. Any other color as per directed by Engineer In charge
- Game line Paint: Pulastic Line paint W: a pigmented, two-component, water-dispersed polyurethane paint.
- Color Options: As per the direction of Engineer In charge.

10.24.3 Construction Requirements

10.24.3.1 Inspection

- Inspect concrete slab for proper levelness tolerance, dryness, and possible contamination,
- All work required to put the concrete subfloors in acceptable condition shall be the responsibility of the contractor.
- Subfloor shall be broom cleaned by contractor.
- General Contractor will notify the flooring installation company to proceed with the installation after concrete slab specifications are met.
- Installer shall perform tests for moisture and adhesion prior to application and report adverse conditions to the responsible person in writing.
- Installer shall document all working conditions provided in General Specifications prior to commencement of installation.

10.24.3.2 Installation

A. Pulastic

1. Shock Pad
 - a. Mix two-component Tacky Adhesive according to supplier's instructions and spread adhesive using notched trowel.
 - b. Unroll polyurethane/rubber granulated base mat into freshly applied adhesive. Seams shall be in virtual contact with absence of compression fit. Roll surface of base mat with a medium-size roller.
2. Sealer:
 - a. Mix two-component EG Sealer according to supplier's instructions and spread sealer over base mat using a straight trowel. Allow to cure minimum 12 hours before proceeding.
3. Structure Layer:
 - a. Mix two-component ROBBINS PULASTIC GM1500 pigmented polyurethane resin and apply at proper thickness according to supplier's instructions. Allow to cure minimum 12 hours before proceeding.
4. Surface Coating:
 - a. Mix two-component ROBBINS PULASTIC Coating Multi-Coat and apply using ROBBINS PULASTIC lambswool roller(s) according to suppliers' instructions. Allow 24 to 48 hours curing time before proceeding.
5. Game lines
 - a. Mix two-component ROBBINS PULASTIC PU- Line paint W according to supplier's instructions.
 - b. Line painting should be in accordance with supplier's directions.
 - c. Color of court markings shall be chosen from ROBBINS PULASTIC PU-Line paint standard colors.
 - d. Consult architectural drawings for game line locations and chosen colors.

10.24.3.3 Precautionary Measures

- Do not install floor system until concrete has been cured and the requirements in these specifications has met
- Clean up all unused materials and debris and remove from the premises. Dispose of empty containers in accordance with federal and local regulations.
- No traffic or other trades shall be allowed on the surface for a period of one week following completion to allow for complete and proper cure of the finish.
- No smoking, open flames or sparks from electrical equipment or any other source shall be permitted during the installation process, or in areas where materials are stored.

10.24.4 Measurement & Payment

Floor should be measured in square feet and paid accordingly. Payment shall be included of labor rate and composite rate. No extra payment shall be paid to contractor on account of replacing substandard work.

Contents

Chapter – 11	SURFACE RENDERINGS	4
11.1	Plastering	6
11.1.1	Surface preparation for Plaster Work.....	6
11.1.2	Defects in Plaster work and their remedies	6
11.1.3	Cement Sand Plaster.....	7
11.1.4	Lime Plaster	9
11.1.5	Lime Cement Sand Plastering	10
11.1.6	Architectural Plaster Finishes	11
11.1.7	Plastering on Lathing.....	11
11.1.8	Colored Cement Sand Plastering.....	12
11.1.9	Colored Limed Plastering	13
11.1.10	Mud Plaster	14
11.1.11	Gypsum Plaster	15
11.1.12	Ornamental Plaster	22
11.1.13	Mortar / Plaster Spraying Machine	23
11.2	Pointing.....	23
11.2.1	Description.....	23
11.2.2	Preparation of Surface.....	24
11.2.3	Application Process	24
11.2.4	Measurements.....	24
11.2.5	Rates.....	25
11.3	Whitewashing.....	25
11.3.1	Preparation and Application Process.....	25
11.3.2	Application	25
11.3.3	Measurements.....	26
11.4	Cement Wash	26
11.4.1	Description.....	26
11.4.2	Application.....	26
11.4.3	Other Respect	26
11.4.4	Measurements.....	26
11.4.5	Rates.....	26
11.5	Color Washing	28
11.5.1	Application Process	28
11.5.2	Measurements.....	28

11.5.3	Rates.....	28
11.6	Vinyl Emulsion.....	28
11.6.1	Materials	29
11.6.2	Preparation of Surfaces.....	29
11.6.3	Mixing and Application.....	29
11.6.4	Measurements.....	29
11.6.5	Rates.....	30
11.7	Plastic Emulsion.....	30
11.7.1	General.....	30
11.7.2	Preparation of Surfaces.....	31
11.7.3	Mixing and Application.....	31
11.7.4	Other Respects.....	32
11.7.5	Measurements.....	32
11.7.6	Rates.....	32
11.8	Distempering.....	34
11.8.1	General.....	34
11.8.2	Preparation of Surface.....	34
11.8.3	Preparation of Distemper.....	34
11.8.4	Application.....	34
11.8.5	Measurement.....	35
11.9	Wall Covering / Architectural Covering.....	36
11.9.1	Description.....	36
11.9.2	Definition.....	36
11.9.3	Appearance.....	37
11.9.4	Wall Preparation and Installation.....	37
11.9.5	Physical Requirements.....	38
11.9.6	Rejection and Review.....	38
11.9.7	Measurement.....	39
11.9.8	Rate.....	39
11.10	Stucco Cement Plaster.....	41
11.10.1	Scope.....	41
11.10.2	Materials	41
11.10.3	Mix Preparation.....	41
11.10.4	Thickness	42
11.10.5	Application of Plaster.....	42
11.10.6	Measurement.....	42

11.11	Alucobond (Face Cladding)	43
11.11.1	References	43
11.11.2	Samples Submittal	43
11.11.3	Delivery, Storage and Handling.....	44
11.11.4	Execution of Works	44
11.11.5	Measurement and Payment.....	45
11.11.6	References	45

Chapter – 11 SURFACE RENDERINGS**References:**

Sr.#	Standard Name	Description
Chapter – 11 Surface Renderings		
ASTM		
1.	ASTM C 841	Standard Specification for Installation of Interior Lathing and Furring.
2.	ASTM C 59	Standard Specification for Gypsum Casting Plaster and Gypsum Molding Plaster.
3.	ASTM C 61	Standard Specification for Gypsum Keene's Cement.
4.	ASTM C 206	Standard Specification for Finishing Hydrated Lime.
5.	ASTM C 5	Standard Specification for Quicklime for Structural Purposes.
6.	ASTM C 35	Standard Specification for Inorganic Aggregates for Use in Gypsum Plaster.
7.	ASTM C 631	Standard Specification for Bonding Compounds for Interior Gypsum Plastering.
8.	ASTM F 793	Standard Classification of Wall Coverings by Use Characteristics.
9.	ASTM E 330	Structural Performance of Exterior Windows, Curtain Walls, and Doors under the Influence of Wind Loads
10.	ASTM E 283	Rate of Leakage through Exterior Windows, Curtain Walls, and Doors
11.	ASTM D 1781	Climbing Drum Peel Test for Adhesives
12.	ASTM E 84	Surface Burning Characteristics of Building Materials
13.	ASTM D 1929	Standard Test for Ignition Properties of Plastics
14.	ASTM D 3363	Method for Film Hardness by Pencil Test
15.	ASTM D 2794	Resistance of Organic Coatings to the Effects of Rapid Deformation (Impact)
16.	ASTM D 3359	Methods for Measuring Adhesion by Tape Test
17.	ASTM D 2247	Practice for Testing Water Resistance of Coatings in 100% Relative Humidity
18.	ASTM B 117	Method of Salt Spray (Fog) Testing
19.	ASTM D 2244	Calculation of Color Differences from Instrumentally Measured Color Coordinates
20.	ASTM D 4214	Evaluating the Degree of Chalking of Exterior Paint Films
21.	ASTM D 822	Practice for Operating Light and Water Exposure Apparatus (Carbon-Arc Type) for Testing Paint, Varnish, Lacquer, and Related Products
22.	ASTM D 1308	Effect of Household Chemicals on Clear and Pigmented Organic Finishes
23.	ASTM A446 / A446M-91	Specification for Steel Sheet, Zinc-Coated (Galvanized) by the Hot-Dip Process, Structural (Physical) Quality.
24.	ASTM A525-91b	Specification for General Requirements for Steel Sheet, Zinc-Coated (Galvanized) by the Hot-Dip Process
25.	ASTM A641-92	Specification for Zinc-Coated (Galvanized) Carbon Steel Wire.

26.	C635-91	Specification for the Manufacture, Performance and Testing of Metal Suspension Systems for Acoustical Tile and Lay-In Panel Ceilings.
27.	E84-91a	Test Method for Surface Burning Characteristics of Building Materials
28.	E119-88	Method for Fire Tests of Building Construction Materials.
29.	E488-90	Test Method for Strength of Anchors in Concrete and Masonry Elements.
30.	E580-91	Practice for Application of Ceiling Suspension Systems for Acoustical Tile and Lay-In Panels in Areas Requiring Seismic Restraint.
31.	E. 95-92	Practice for Mounting Test Specimens during Sound Absorption Tests.
32.	E1190-87	Test Methods for Strength of Powder Actuated Fasteners Installed in Structural Members.
33.	EI 264-90	Classification of Acoustical Ceiling Products.
BS		
34.	BS-CP-231	Specifications for paints for Buildings.

11.1 Plastering

Plasters shall be applied to bases of bricks, stones, hollow tiles, or concrete masonry, and to wood laths, metal laths and gypsum laths or similar materials finished in sheets. Except otherwise specified, all plaster work shall be carried out in conformity with BS CP-211 "Internal Plastering and CP-221 "External Rendering and Finishes".

11.1.1 Surface preparation for Plaster Work

11.1.1.1 Substrates

- Surfaces of substrates for the application of gypsum plaster shall be free of materials that will inhibit bond or adhesion, shall be straight, plumb, level, square, and true to required plan angles and curves.
- All accessories shall be securely attached to the substrate and be installed to permit embedment of flanges.
- Gypsum and Metal Lath – Shall have been installed in compliance with ASTM C 841.

11.1.1.2 Conditioning

All depressions in masonry and concrete surfaces deeper than 1/8 inch (3.2mm) shall be brought flush to the surface with compatible materials prior to plaster application. Fins or protrusions extending more than 1/16 inch (1.6mm) from the surface shall be removed. Protrusions less than 1/16 inch (1.6mm) shall be feathered out with compatible materials prior to plaster application.

11.1.1.3 Masonry

- All masonry surfaces shall be wetted immediately prior to the plaster application. No free water shall remain visible on the substrate surface.
- Where the surface is too smooth to provide mechanical key, the surface shall be roughened or bonding compound shall be used.
- Where bond cannot be obtained over the entire surface by the methods, self-furring metal lath shall be used in accordance with ASTM C 841.

11.1.1.4 Monolithic Concrete

- Bonding compounds shall be used prior to plastering all monolithic concrete surface.
- Grounds, beads, and screeds shall be installed prior to the plastering as modified herein.

11.1.1.5 Grouting

- Metal bases for solid partitions shall be grouted with gypsum plaster leaving approximately ¼ in. (6.4 mm) below the top edge of the base, and be formed with a center groove that will permit the lath to extend ¾ in. (19 mm) below the top edge of the base, or plaster grout shall be placed after installation of lath.
- Metal Frames - Hollow door and window frames shall be filled with gypsum plaster grout.

11.1.2 Defects in Plaster work and their remedies

Various defects observed on plaster along with their causes are given below: -

11.1.2.1 Cracks

Cracks briefly occur on account of: -

- Structural defects in building and discontinuity of surface.
- Plastering on very wet background.
- Old surface not properly prepared.
- Over-rapid drying.
- Excessive shrinkage of the plaster owing to thick coats and richer mixes.

11.1.2.2 Pitting and Blowing

These defects are noticed in case of faulty slaking and hydration of the lime particles in the plaster.

11.1.2.3 Falling out

Plaster falls out mainly on account of: -

- Lack of adhesion for not having formed a proper "key" in the background
- Excessive moisture in the background
- Excessive thermal changes either in the background or in plaster itself
- Rapid drying
- Insufficient drying between each coat of plaster.

11.1.2.4 Removal of Defects in Plaster Work

Hair-cracks on fresh plaster normally disappear after whitewashing. But wide cracks shall be filled in by forcing down mortar consisting of Plaster of Paris, cement and sand in the proportion of 1:2:7, unless otherwise specified or directed by the Engineer-in-charge.

Surface areas showing pitting, blowing, popping and blister shall be remedied by cutting out patches in rectangular shape, under cutting the edges to form a dovetail key and making good on a Portland cement ground.

All these remedial measures shall be carried out by the contractor at his own expense.

11.1.3 Cement Sand Plaster

11.1.3.1 Description

This works shall consist of plastering brick work or stone masonry or concrete with cement sand mortar of specified proportions and thickness in conformity with lines and dimensions shown on the drawings and shall conform with these specifications.

11.1.3.2 Material Required

Cement, Lime and Water shall be as specified in Chapter-3 of Book-1 (Specification for Engineering Material). Sand shall be of medium coarse grain obtained from local approved queries subject to the approval of Engineer in Charge and/or shall conform to BS 199 "Building Sand from Natural Resources."

Additives including non-metallic surface hardener shall be of approved make, utilized as per printed instructions of the manufacturer and as approved by the Engineer in Charge.

11.1.3.3 Samples

All materials for plastering shall be used after approval from the Engineer in Charge and same type of material used throughout the work in progress. If the Engineer in Charge requires any of the material to be tested, it shall be done by the contractor at his own cost from a laboratory approved by the Engineer in Charge or his representative before the work is commenced.

11.1.3.4 Mortars and Proportions of Mortars

The ingredients of mortar shall be proportioned as mentioned in the BOQ of the contract. The following proportions (by volume) of dry materials shall be used as specified.

Cement	:	Sand
1	:	2
1	:	3
1	:	4
1	:	5

11.1.3.5 Plastering

Unless otherwise specified or directed by the Engineer-in-charge or his authorized subordinate in writing, wooden screeds three inches wide and having a thickness equal to the plaster shall be fixed vertically 8 feet to 10 feet apart to act as gauges and guides in applying the plaster. The arises shall then be plastered for a space of four inches on each side and up to the ceiling, except in case of openings where it shall run around them. This plaster shall also serve as a guide for thickness etc. Unless otherwise specified or directed by the Engineer-in-charge all corners and arises shall be rounded off to a radius of 3/4 inch only and no more. This work is included in the unit rate of plastering. The mortar shall be laid on the wall between the screeds, using a plasterer's float for the purpose and pressing mortar so that the raked joints are properly filled. The plaster shall then be finished off with a wooden straight-edge reaching across the screeds. The straight-edge shall be worked on the screeds with an upward and sideways motion, two inches or three inches at a time. Finally, the surface shall be finished off with a plasterer's wooden float. Metal floats shall not be used. The plaster shall be laid to a true and plumb surface and tested frequently with a straight-edge and plumb-bob. The straight-edge shall not be less than 10 feet in length. As the work proceeds, all horizontal lines and surfaces shall be tested with a level, and all jambs and corners with a plumb-bob. All moldings and decorations shall be worked true to template and shall be neat, clean, level, and parallel, or truly plumb, as the case may be. Unless otherwise specified, plaster shall not exceed half an inch in thickness and shall not be less than quarter of an Inch at the thinnest part.

11.1.3.6 Coats

Plaster may be applied in 1, 2 or 3 coats; 2 are usually sufficient, but 3 should be applied only on wood or metal lathing or on a very rough, uneven background. The thickness of the first coat has to be just sufficient to fill up unevenness in the surface. The second and subsequent coat are thinner than the first, and no single coat shall have more than 3/8-inch of thickness, as backing coat and final coat. The backing coat shall be carried to full length of walls. The

backing coat shall be roughened with waving lines drawn by wire brushes when wet, to provide bond for final coat. The final coat shall be applied only after the backing coat has been properly cured and wetted, and finished with wooden floats to present smooth and uniform surface. Defective works shall be dismantled and redone to the satisfaction of the Engineer in Charge at contractor's expenses. All putlog holes shall be filled up in advance of the plastering as the scaffolding is being taken down. The plaster shall be kept wet for 10 days and protected from ambient temperatures and weather. Plaster stops and beads shall be of galvanized metal or as approved and shall be where shown on the drawing.

Plaster containing cracks, blisters, pits etc. or discoloration shall be removed and replaced with plaster matching existing work in colour and texture as approved by the Engineer in Charge or his representative. Floating coat of neat cement if specified in BOQ shall be applied while the plaster is still green and the surface rubbed smooth with steel trowels. If trowel marks are visible after the surface has been finished, it may be required to be redone.

11.1.3.7 Curing

The plastered surface shall be protected from the sun, hot winds by wet screens till it has hardened sufficiently to remain unaffected by the external application of water. It shall then be watered and kept damp for a period of at least ten days and allowed to dry as slowly as possible.

11.1.3.8 Measurements

Plastering shall be measured by the superficial area; no deduction being made for the openings of doors or windows of any size or additions or returns and soffits from any of the two sides. The unit of measurement shall be 100 sq. ft. or one sq. meter. Ornamental work to finished and plastered shall be measured and paid separately and their unit of measurement shall be 1 foot or 1 meter (linear).

11.1.3.9 Rates

The unit rate shall include

11.1.3.9.1 Labour Rate

When only labour rate is to be paid.

- Preparing, cleaning and watering the surface to be plastered.
- Plastering surfaces and corners as per above specifications.
- Curing and protecting the plaster after completion for 10 days.
- Providing, erecting and removing scaffoldings.
- Providing tools such as special floats, straight edges, levels and plumb bobs.

11.1.3.9.2 Composite Rate

When rate for completed job is to be paid all items mentioned in Heading 11.1.3.9.1 and cost of all materials used at site of work for plastering.

11.1.4 Lime Plaster

The lime used for plastering ranges from fat lime to strong hydraulic lime. Fat lime is most commonly used on account of its yield of lime putty and ease in application in lime plaster.

However, fresh slaked lime is superior in quality: Coarse, sharp sand is used with lime. Lime and sand plaster are weak and soft and takes a long time to harden. Fine stuff for finishing coat is made by mixing water with a thoroughly slaked lime to bring it to the consistency of cream and left to settle. Superfluous water is either poured off or allowed to evaporate till the cream attains proper thickness. An equal volume of sand is then added. To improve their quality lime mortars may be gauged with cement or Surkhi. Lime plaster on walls which have to be whitewashed is not finished very smooth to allow the whitewash to stick to the surface. The plastered surface is kept wet for several days to prevent it from cracking.

11.1.5 Lime Cement Sand Plastering

11.1.5.1 Description

The work shall consist of plastering brickwork or stone masonry with lime cement sand mortar in conformity with lines and dimensions as shown on the drawing and in accordance with these specifications.

11.1.5.2 Mortar

The mortar shall conform to Chapter-5 of Book-2 of these specifications. The ingredients of mortar shall be proportioned as mentioned in the BOQ of the contract.

11.1.5.3 Plastering

Unless otherwise specified or directed by the Engineer-in-charge or his authorized subordinate in writing, wooden screeds three inches wide and having a thickness equal to the plaster shall be fixed vertically 8 feet to 10 feet apart to act as gauges and guides in applying the plaster. The arises shall then be plastered for a space of four inches on each side and up to the ceiling, except in case of openings where it shall run around them. This plaster shall also serve as a guide for thickness etc. Unless otherwise specified or directed by the Engineer-in-charge all corners and arises shall be rounded off to a radius of 3/4 inch only and no more. This work is included in the unit rate of plastering. The mortar shall be laid on the wall between the screeds, using a plasterer's float for the purpose and pressing mortar so that the raked joints are properly filled. The plaster shall then be finished off with a wooden straight-edge reaching across the screeds. The straight-edge shall be worked on the screeds with an upward and sideways motion, two inches or three inches at a time. Finally, the surface shall be finished off with a plasterer's wooden float. Metal floats shall not be used. The plaster shall be laid to a true and plumb surface and tested frequently with a straight-edge and plumb-bob. The straight-edge shall not be less than 10 feet in length. As the work proceeds, all horizontal lines and surfaces shall be tested with a level, and all jambs and corners with a plumb-bob. All mouldings and decorations shall be worked true to template and shall be neat, clean, level, and parallel, or truly plumb, as the case may be. Unless otherwise specified, plaster shall not exceed half an inch in thickness and shall not be less than quarter of an Inch at the thinnest part.

11.1.5.4 Protection during Curing

After completion, plaster shall be kept wet for 10 days and shall be protected during that period from extreme fluctuations of temperature and weather.

11.1.5.5 Measurements

Plastering shall be measured by the superficial area; no deduction being made for the openings of doors or windows of any size or additions or returns and soffits from any of the two sides. The unit of measurement shall be 100 sq. ft. or sq. meter. Ornamental work to finished and plastered shall be measured and paid separately and their unit of measurement shall be 1 foot or 1 meter (linear).

11.1.5.6 Rates

The unit rate shall include as follow: -

11.1.5.6.1 Labour Rate

When only labour rate is to be paid: -

- Preparing, cleaning and watering the surface to be plastered.
- Plastering surfaces and corners as per above specifications.
- Curing and protecting the plaster after completion for 10 days.
- Providing, erecting and removing scaffoldings.
- Providing tools such as special floats, straight edges, levels and plumb bobs.

11.1.5.6.2 Composite Rate

When rate for completed job is to be paid all items mentioned in Heading 11.1.5.6.1 and cost of all materials used at site of work in plastering.

11.1.6 Architectural Plaster Finishes

There are usually the following 3 types of finishing falling under this head.

- i. **Rough Cast:** A wet plastic mix of 3-parts cement, 1-part lime, 6-parts sand and 4-parts of shingle graded between ¼" and ½" or crushed stone, which is thrown on the wall by means of a scoop or plasterer's trowel.
- ii. **Pebble-Dash:** A ⅜" coat of 1-part cement, 1-part lime and 5-parts sand are laid. Shingle grades between ¼" and ½" is thrown while the coat is still soli.
- iii. **Ornamental Finishes:** A mix of approximately 1-part cement, 1½-parts lime and 6-part sand which after application is finished by the use of combs, trowels, or a special tool.

11.1.7 Plastering on Lathing

Lathing constitutes a convenient base in some form of construction for plastering on wall and ceilings. Metal lathing, the most commonly used, is fixed to timber support by galvanized wire nails or staples at short distance. It is also often used to bridge the junction of two dissimilar backgrounds, or to provide a suitable key for plastering over a wooden beam. Metal lathing may be of expanded metal or woven wire, etc., which shall weigh not less than 12 lbs. per 100 square feet, except when used to provide the key. Lathing shall be stretched tight with the help of some tension device such as mild steel rods since plaster would crack on a loose lathing. After cleaning the rust, if any, the lathing shall be brushed with cement slurry. Most common defects in plaster on metal lathing are extensive cracking, particularly along the line

of fixing of the lathing to its support or unevenness of the finished plastered surface, that shall be redone at the cost of the contractor. Hair cracks generally disappear with whitewashing. Wider cracks can be filled in by forcing down a mortar consisting of plaster of Paris, cement and sand in the proportion of 1:2:7 by weight. The mortar should be prepared in a quantity which must be consumed within half an hour.

11.1.8 Colored Cement Sand Plastering

11.1.8.1 Description

This work shall consist of coloured cement sand plastering and polishing on brickwork or stone work with coloured cement putty conforming to the lines and dimensions as shown on the drawing and in accordance with these specifications.

11.1.8.2 Use

When it is not required to subsequently paint, distemper or colour-wash the cement plaster, it shall be finished to the final colour and polished. Plasterer's putty shall be used for the finishing coat.

11.1.8.3 Finishing Coat

The finishing coat of plasterer's putty prepared as above shall be applied on the floated coat after it has set. The floated coat shall be finished according to specifications for single coat or double coat, as the case may be. The thickness of this coat shall be 1/8th of an inch unless otherwise specified. The surface shall be rubbed smooth with a steel plasterer's trowel to give it a polished surface.

11.1.8.4 Other Aspects

In all other respects, not specified here, this shall conform to the Headings of 11.2 & 11.3 of these specifications.

11.1.8.5 Measurements

Plastering shall be measured by the superficial area; no deduction being made for the openings of doors or windows of any size or additions or returns and soffits from any of the two sides. The unit of measurement shall be 100 sq. ft. or one sq. meter. Ornamental work to finished and plastered shall be measured and paid separately and their unit of measurement shall be 1 foot or 1 meter (linear).

11.1.8.6 Rates

The unit rate shall include: -

11.1.8.6.1 Labour Rate

When only labour rate is to be paid: -

- Preparing, cleaning and watering the surface to be plastered.
- Plastering surfaces and corners as per above specifications.

- Curing and protecting the plaster after completion for 10 days.
- Providing, erecting and removing scaffoldings.
- Providing tools such as special floats, straight edges, levels and plumb bobs.

11.1.8.6.2 Composite Rate

When rate for completed job is to be paid all items mentioned in Heading 11.1.8.6.1 and cost of all materials used at site of work for plastering.

11.1.9 Colored Limed Plastering

11.1.9.1 Description

This work shall consist of coloured lime plaster and polishing on brickwork or stone work with coloured lime putty conforming to the lines and dimensions as shown on the drawing and in accordance with these specifications.

11.1.9.2 Use

When it is not required to subsequently paint, distemper or colour-wash the lime plaster, it shall be finished to the final colour and polished. Plasterer's putty shall be used for the finishing coat.

11.1.9.3 Plasterer's Putty

Unless otherwise specified plasterer's putty shall be made as follows: Pure fat lime shall be slaked and then immersed in water for at least 48 hours. The lime shall then be thoroughly stirred with water and strained through muslin cloth. On settling, the surplus water shall be removed and further water allowed to evaporate, till the paste becomes thick enough for use. Suitable pigments are added to it to obtain the desired colour as directed by the Engineer-in-charge.

11.1.9.4 Finishing Coat

The finishing coat of plasterer's putty prepared as above shall be applied on the floated coat after it has set. The floated coat shall be finished according to specifications for single coat or double coat, as the case may be. The thickness of this coat shall be 1/8th of an inch unless otherwise specified. The surface shall be rubbed smooth with a steel plasterer's trowel to give it a polished surface.

11.1.9.5 Other Aspects

In all other respects, not specified here, this shall conform to the Headings 11.2 & 11.3 of these specifications.

11.1.9.6 Measurements

Plastering shall be measured by the superficial area; no deduction being made for the openings of doors or windows of any size or additions or returns and soffits from any of the two sides. The unit of measurement shall be 100 sq. ft. or sq. meter. Ornamental work to

finished and plastered shall be measured and paid separately and their unit of measurement shall be 1 foot or 1 meter (linear).

11.1.9.7 Rates

The unit rate shall include: -

11.1.9.7.1 Labour Rate

When only labour rate is to be paid: -

- Preparing, cleaning and watering the surface to be plastered.
- Plastering surfaces and corners as per above specifications.
- Curing and protecting the plaster after completion for 10 days.
- Providing, erecting and removing scaffoldings.
- Providing tools such as special floats, straight edges, levels and plumb bobs.

11.1.9.7.2 Composite Rate

When rate for completed job is to be paid all items mentioned in Heading 11.1.9.7.1 and cost of all materials used at site of work in plastering.

11.1.10 Mud Plaster

11.1.10.1 Description

The work shall consist of applying mud plaster on walls, roofs and floors in conformity with lines and dimension shown on the drawings and in accordance with these specifications.

11.1.10.2 Preparation of Surfaces

Before plastering, the joints of old brickwork or masonry shall be raked out with a hook (not hammer or tessi) to a depth of half an inch. The earth and mortar dust coming out of these joints as a result of raking shall be removed with wire brush 24 hours before mortar is applied. All putlog holes shall be filled up before plastering, as the scaffolding for masonry is being taken down.

11.1.10.3 Plastering

The arrises shall be plastered for a space of four inches on each side and up to the ceiling, except in case of openings where it shall run around them. This plaster shall also serve as a guide for thickness etc. Unless otherwise specified or directed by the Engineer-in-charge all corners and arrises shall be rounded off to a radius of $\frac{3}{4}$ inch only and no more. This work is included in the unit rate of plastering. The mortar shall then be spread evenly over the wall so as to be not more than $\frac{3}{4}$ inch thick. After spreading, the mortar shall be floated with a straight-edge, till the surface is perfectly smooth, level and true. The plaster shall be laid to a true and plumb surface and tested frequently with a straight-edge and plumb-bob. The straight-edge shall not be less than 10 feet in length. As the work proceeds, all horizontal lines and surfaces shall be tested with a level, and all jambs and corners with a plumb-bob. All mouldings and decorations shall be worked true to template and shall be neat, clean, level and parallel or truly plumb as shown of drawings. Unless otherwise specified, plaster shall not

exceed ¾" in thickness on walls and 1" on floors and roofs. Any cracks that open out during drying shall be filled with liquid cow-dung.

11.1.10.4 Other Aspects

In all other respects, not specified here, this shall conform to the Headings of 11.1.2 & 11.1.3 of these specifications.

11.1.10.5 Measurements

Plastering shall be measured by the superficial area; no deduction being made for the openings of doors or windows of any size or additions or returns and soffits from any of the two sides. The unit of measurement shall be 100 sq. ft. or one sq. meter. Ornamental work to finished and plastered shall be measured and paid separately and their unit of measurement shall be 1 foot or 1 meter (linear).

11.1.10.6 Rates

The unit rate shall include:

11.1.10.6.1 Labour Rate

When only labour rate is to be paid: -

- Preparing, cleaning and watering the surface to be plastered.
- Plastering surfaces and corners as per above specifications.
- Curing and protecting the plaster after completion for 10 days.
- Providing, erecting and removing scaffoldings.
- Providing tools such as special floats, straight edges, levels and plumb bobs.

11.1.10.6.2 Composite Rate

When rate for completed job is to be paid all items mentioned in Heading 11.1.10.6.1 and cost of all materials used at site of work for plastering.

11.1.11 Gypsum Plaster

11.1.11.1 Description

This specification covers the minimum requirement for full-thickness interior gypsum plastering on metal, masonry, or monolithic concrete bases designed or prepared to receive gypsum plaster.

11.1.11.2 Delivery of Materials

All manufactured materials shall be delivered in the original packages, container, or bundles bearing the brand name and manufacturer (or supplier) identification.

11.1.11.3 Protection

Plasters and other cementitious materials shall be kept dry until used; they shall be stored off the ground, under cover, and away from walls with condensation and other damp surfaces. Metal products shall be protected, which stored, against rusting.

11.1.11.4 Environmental Conditions

11.1.11.4.1 Temperature

When the ambient outside temperature at the building site is less than 55°F (13°C), a temperature of not less than 55°F (13°C) and not more than 80°F (27°C) shall be maintained continuously inside the building for a period of not less than one week prior to the application of plaster, while the plastering is being applied, and for one week after the plaster has set, or until the plaster has dried. Heat shall be distributed evenly by using deflective or protective screens to prevent concentrated or uneven heat or cold on the plaster.

11.1.11.4.2 Ventilation

Sufficient ventilation shall be provided to remove excess water given off through the drying process.

11.1.11.5 Materials

Materials shall conform to these specifications.

11.1.11.5.1 Gypsum Casting and Molding Plaster

This shall conform to ASTM Specification C 59.

11.1.11.5.2 Gypsum Keene's Cement

This shall conform to ASTM Specification C 61.

11.1.11.5.3 Lime

(a) Finishing Hydrated Lime

This shall conform to ASTM Specification C 206, Type S.

(b) Quicklime for Structural Purposes

This shall conform to ASTM Specification C 5.

11.1.11.5.4 Lime Putty

Lime putty exceeding 8 weight % of un-hydrated magnesium oxide shall not be used for finish coat plaster.

11.1.11.5.5 Aggregates

(a) Aggregates for Base Coat Plaster

This shall conform to ASTM Specification C 35.

(a) Aggregates for Finish Coat Plaster

- This shall conform to Specification specified in table- 2 'Aggregate for Finish Coat Plasters, Percentage Retained on Each Sieve, Cumulative'.
- Sand for job mixed lime putty-gypsum gauged, sand float finish shall be graded within the limits specified in table-3 'Sand for Job-Mixed Lime Putty-Gypsum Gaged Sand Float Finish, Percent Retained on Each Sieve by Weight, Cumulative'.

11.1.11.5.6 Water

Water used in mixing and finishing plaster shall be clean, fresh, suitable for domestic water consumption, and free of such amounts of mineral or organic substances that affect the set, the plaster, or any metal in the system.

11.1.11.5.7 Metal Products

Metal products shall meet the appropriate product standard, have a protective coating, and be approved for the intended use.

11.1.11.5.8 Bonding Compounds

This shall conform to ASTM Specification C 631.

11.1.11.6 Surface Preparation

See the Heading 11.1.1.

11.1.11.7 Mix Design

11.1.11.7.1 Mixing General

All plaster mixing shall be done by mechanical means unless hand mixing is specified.

- Re-tempered, partially set, frozen, caked or lumpy material shall not be used.
- Each batch shall be mixed separately and mixers shall be free of all set and hardened materials prior to mixing each batch.
- All tools shall be kept clean.
- The setting time shall be permitted to be adjusted but in no case shall the setting time be more than 4 h.

11.1.11.7.2 Hand Mixing

When permitted by the engineer.

11.1.11.7.3 Mechanical Mixing

In accordance with manufacturer's printed directions.

11.1.11.7.4 Base Coat Proportions

(a) Gypsum Neat Plaster

Proportions of sand, perlite, or vermiculite aggregate to 100 lb. (45.4 kg) of gypsum neat plaster shall be not more than those specified in Table- Base Coat Proportions.

(b) Gypsum Wood-Fibered Plaster

Proportion of damp, loose sand or perlite or vermiculite shall be not more than 1 ft³ (0.028 m³) to 100 lb (45.4 kg) of gypsum wood-fibered plaster.

11.1.11.7.5 Preparation of Lime Putty

- (a) Lime putty shall be prepared from Type S hydrated lime or pulverized quicklime, in accordance with the manufacturer's printed directions.
- (b) Hydrated Lime - Type S lime shall only be used after soaking for the time period required in accordance with the manufacturer's printed directions.

11.1.11.7.6 Finish Coat Proportion

- Finish coats shall be either ready mixed or job mixed in accordance with table-5 and table 7. Where thickness of the finish coat is more than 1/8 in (3.2mm), the proportion of the gypsum gauging plaster shall be increased to minimize shrinkage type cracks.
- (a) Troweled Finishes of lime putty gauged with gypsum gauging plaster or ready mixed gypsum plaster shall be proportioned in accordance with table-7.
- Where finish in (b) is to be applied over base coats containing perlite or vermiculite, the addition of not less than ½ ft³ (0.14 m³) or not more than 1 ft³ (0.028 m³) of fine aggregate meeting the sieve analysis of table-2 shall be added to the mix.
- (c) Troweled finishes of lime putty gauged with gypsum Keene's cement shall be specified as medium or hard and shall be proportioned in accordance with table 7.
- When finish in (c) is mechanically mixed, the water shall be placed in the mixer first, then the lime, the fine aggregate (if used), and finally the gypsum Keene's cement.
- (d) Troweled finishes of gypsum ready mixed plaster shall be mixed in accordance with table 7.
- (e) Float finishes of lime putty gauged with gypsum gauging plaster shall be proportioned in accordance with Table-7.
- When finish in (e) is to be mixed with sand, the sand shall be graded within the limits shown for basecoats in ASTM Specification C35 except that all of the sand shall pass a No.8 (2.36mm) sieve.
- (f) Float finishes of lime putty gauged with gypsum Keene's cement shall be proportioned in accordance with Table-7.
- When the finish in (f) is to be mechanically mixed wet, follow procedures in (ci) For mixing dry, add lime first, then gypsum Keene's cement, and sand. This dry mix shall be mixed to a uniform color and then add water to achieve the desired consistency.
- (g) Float finishes of job mixed gypsum and sand shall be proportioned in accordance with table-5 and Table-7.
- (h) Float finishes of ready mixed plaster and sand shall be mixed with water only in accordance with the manufacturer's printed directions.
- (i) Float finishes of job mixed plaster shall be proportioned in accordance with table-5.
- (j) Float or textured ready mixed coloured plaster shall be mixed in accordance with the manufacturer's printed directions.
- (k) Float or textured job mixed colour plaster shall be proportioned in accordance with table-5 and table-7.
- (l) Special finishes shall be proportioned in accordance with the applicable provision of table-5 and table-7.

11.1.11.8 Applications**11.1.11.8.1 General**

Plaster shall be applied by hand or machine as specified herein.

11.1.11.8.2 Plaster Thickness

- (a) Gypsum plaster shall be applied to the thickness specified in table-6. Plaster thickness shall be measured from the face plane of all plaster bases.

11.1.11.8.3 Application of Base Coats**(a) Two-Coat Work**

The first coat shall be applied with sufficient material and applied with enough pressure to form a good bond to the substrate. The second coat shall be applied by doubling back before the first coat sets and with the plaster brought out to the grounds or screeds or specified thickness.

- The plaster shall be straightened to a true plane without application of water leaving the surface porous and rough enough to provide a mechanical bond for the finish coat.

(b) Three-Coat Work

The first coat or scratch coat shall be applied with sufficient material and applied with enough pressure to form tight contact with and a good bond to solid plaster bases, or to form full keys through metal reinforcement. The first coat shall have sufficient depth of material leaving the surface sufficiently porous and rough (scratch or raked) to provide mechanical bond for the second or brown coat.

- After the first or scratch coat has set, screeds shall be applied over the first coat prior to application of the second coat to ensure full plaster thickness. The second or brown coat shall be applied with sufficient material and pressure to ensure tight contact with the scratch coat and to bring the thickness of the second coat out to the grounds or specified thickness. The second coat shall straighten the surface to a true plane without application of water, and leave the surface sufficiently porous and rough enough to provide mechanical bond for the third or finish coat.
- Metal base and metal frames for hollow partitions shall be plaster grouted prior to plastering, or shall be grouted solid between base or frame and plaster base at the time of plastering.

(c) Plastering on Monolithic Concrete

All applicable requirements of (11.1.1.1), 11.1.1.1.a, 11.1.1.2, 11.1.1.2.a, 11.1.1.2.a.i, 11.1.1.2.a.iii and table-6 shall be followed.

- Walls and columns shall have a coat of dash-bond, bonding compound or metal plaster base or shall have a two-coat plaster application as provided in (a) with a proportion of gypsum neat plaster to aggregate of 100 lb (45.4 kg) of plaster to not more than 3 ft³ (0.028 m³) of aggregate.
- Ceiling shall be prepared and two coat work applied in accordance with (a).

(d) Solid Plaster Partitions with Steel Studs (Metal Lath and Plaster)

Partitions shall be not less than 2 inch (51mm) thick and shall have scratch, brown, and finish coats applied in accordance with 36-7.8.3.4.1 through 36-7.8.3.4.4. Where studs are temporarily braced, the bracing shall be maintained until the scratch coat on the lath side has set.

- The scratch coat on the lath side shall be applied first, with sufficient material and pressure to form full keys and embed the lath and with sufficient depth of material to be scored to a rough surface immediately following its application.
- The back-up coat on the channel side shall applied in not less than two applications after the scratch coat on the lath side has set and partially dried. The first application shall completely cover the keys of the scratch coat. The second application shall bring the plaster out to the grounds in a true plane with the surface, left porous and sufficiently rough to provide mechanical bond for the finish coat. Extra water shall not be used in straightening the wall to a true plane.
- The brown coat on the lath side shall be applied after the brown coat on the channel side has set, and left as specified for the finish coat.
- Plaster shall extend to the floor, except that where plaster grouted combination metal bases and screeds are used, the plaster shall extend to the grout below the top of the base. Spaces between the grounds and all metal doorframes shall be filled.

(e) Stud-less Solid Partitions (Metal Lath and Plaster)

Partitions shall be not less than 2-inch (51mm) thick constructed using either rib lath or diamond mesh (flat expanded) lath, and with plaster applied in the same number of coats as for solid partitions with steel studs (see d).

- Where rib metal lath is used, the scratch coat shall be applied first to the flat side with temporary bracing on the rib side.
- Where diamond mesh lath is used, the temporary bracing shall be attached to either side or the scratch coat applied on the opposite side.
- Sequence application of brown coats in accordance with one of the following methods:
 - (i) Brown coat shall be applied over the face of the scratch coat followed by the brown coat on the opposite side of the partition, or
 - (ii) Brown coat shall be applied on the rib side of the metal lath, or on the backside of the scratch coat followed by the brown coat applied over the face of the scratch coat.

(f) Stud less Solid Partitions (Gypsum Lath and Plaster)

Partitions shall be not less than 2 inch (51mm) thick and shall be three-coat work on both sides.

- Scratch coat shall be applied approximately $\frac{3}{8}$ -inch (9.5mm) thick with not less than $\frac{3}{16}$ " (4.8mm) thickness at any point. The application shall be started at the side opposite the temporary bracing, then on the braced side without removing the bracing. The thickness shall be the same on both sides.
- The brown coat shall be applied to the side opposite the bracing after the scratch coat has set and is partially dry. The bracing shall be removed when this brown coat has set and is partially dry. Both sides shall have been brought to $\frac{1}{16}$ to $\frac{1}{8}$ inch (1.6mm to 3.2mm) of the required thickness leaving a surface ready to receive a finish coat (see dii), which will bring the partition to an overall thickness of not less than 2 inch (51mm).

(g) Stud less Solid Partitions (Multiple-Thickness Gypsum Lath and Plaster)

Partitions shall be not less than 2 inch (51mm) thick with three coats on each side. Each side shall be not less than ½ inch (12.7mm) thick.

(h) Gypsum Lath Ceilings Attached by Clips

Plastered ceiling with clip attached gypsum lath shall be covered with three-coat work with the scratch coat not less than 3/16 to ¼ inch (4.8mm to 6.4mm) thick over the face of the gypsum lath. The total thickness of scratch and brown coats shall be not less than 7/16 inch (11mm).

11.1.11.8.4 Application of Finishes

- (a) Finish coats shall be applied to a partially dry base coat or to a thoroughly dry base coat that has been evenly wetted by brushing or spraying. No water shall be left standing on the surface prior to plaster application.
- (b) Troweled finishes shall be applied by drawing the first application down tight to the entire base coat surface and doubling back to fill out to a true even surface of from 1/16 to 1/8 inch (1.6mm to 3.2mm) thick, free from catfaces and other blemishes or irregularities. Final troweling or texturing shall be done with a minimum of water after the finish coat has become firm.
 - Lime putt-gypsum gauged Keene's cement finish shall be done in accordance with (b) except that the final troweling shall be continued until the finish has set.
 - Ready mixed gypsum troweled finishes shall be applied in accordance with the printed directions of the manufacturer.
- (c) Textured/float finishes shall be applied in accordance with (b) except the float applied finish shall also meet the requirements of the specific texture required. The texture required shall be created by the type of float surface used (wood, carpet, cork, rubber, or other) and the length of time between trowel application and floating (take-up).
 - The mixes in (b i) and (b ii) used for float finish shall be applied in accordance with (c).
- (d) Texture or special finishes shall be applied in accordance with the printed directions of the manufacturer.
- (e) Job mixed finishes shall be applied in accordance with (b) or (c). The texture or special finish coat shall reduce the total thickness by not more than 1/16 inch (1.6mm) while matching the approved sample as closely as possible.
 - Special finishes shall not reduce the combined thickness of the base coat and finish coat to less than that specified in table 6.
 - Acoustical plaster and finish shall be applied in accordance with the printed directions of the manufacturer.

11.1.11.9 Measurements

As per Heading 11.1.3 of these specifications.

11.1.11.10 Rates

The unite rates shall include:

11.1.11.10.1 Labour Rate

Compensation for labour and T&P to execute item Heading 11.1.11 of the work in accordance with these specifications.

11.1.11.10.2 Composite Rate

It includes cost of materials used in plastering and all items mentioned in Heading 11.1.11.10.1 of these specifications.

11.1.12 Ornamental Plaster

Ornamental plaster shall be provided wherever shown on the Drawings or as directed by the Engineer-in-Charge. It could be either original imported cement, or colored cement or cement mixed with coloring pigment as provided in the item of work. The work shall be carried out in accordance with 11.1.3.

11.1.12.1 Measurement

Length and breadth shall be measured correct to a cm. and area shall be calculated in sqm correct to two places of decimals. Measurements for Jambs, Soffits and Fills etc. for openings shall be as described below: -

Length and breadth shall be measured correct to a cm and its area shall be calculated in square meters correct to two places of decimal. Thickness of the plaster shall be exclusive of the thickness of the key i.e. grooves, or open joints in brick work.

The measurement of wall plaster shall be taken between the walls or partitions (the dimensions before the plaster shall be taken) for the length and from the top of the floor or skirting to the ceiling for the height. Depth of coves or cornices if any shall be deducted. The following shall be measured separately from wall plaster.

- Plaster bands 30 cm wide and under
- Cornice beadings and architraves or architraves moulded wholly in plaster.
- Circular work not exceeding 6 m in radius.

Plaster over masonry pilasters will be measured and paid for as plaster only. A coefficient of 1.63 shall be adopted for the measurement of one side plastering on honey comb work having 6 x 10 cm. opening. Moulded cornices and coves.

- Length shall be measured at the centre of the girth.
- Moulded cornices and coves shall be given in square meters the area being arrived at by multiplying length by the girth.
- Flat or weathered top to cornices when exceeding 15 cm in width shall not be included in the girth but measured with the general plaster work.
- Cornices which are curved in their length shall be measured separately.

Exterior plastering at a height greater than 10 m from average ground level shall be measured separately in each storey height. Patch plastering (in repairs) shall be measured as plastering new work, where the patch exceeds 2.5 sqm. extra payment being made for preparing old wall, such as dismantling old plaster, raking out the joints and cleaning the surface. Where the patch does not exceed 2.5 sqm in area it shall be measured under the appropriate item.'

Cornices and other such wall or ceiling features, shall be measured along the girth and included in the measurements.

1. Deductions in Measurements

For opening etc. will be regulated as follows: -

- No deduction will be made for openings or ends of joists, beams, posts, girders, steps etc. up to 0.5 sqm in area and no additions shall be made either, for the jambs, soffits and sills of such openings. The above procedure will apply to both faces of wall.
- Deduction for opening exceeding 0.5 sqm but not exceeding 3 sqm each shall be made for reveals, jambs, soffits sills, etc. of these openings.
 - When both faces of walls are plastered with same plaster, deductions shall be made for one face only.
 - When two faces of walls are plastered with different types of plaster or if one face is plastered and other is pointed or one face is plastered and other is un-plastered, deduction shall be made from the plaster or pointing on the side of the frame for the doors, windows etc. on which width of reveals is less than that on the other side but no deduction shall be made on the other side. Where width of reveals on both faces of wall are equal, deduction of 50% of area of opening on each face shall be made from area of plaster and/or pointing as the case may be.
 - For opening having door frame equal to or projecting beyond thickness of wall, full deduction for opening shall be made from each plastered face of wall.
- For opening exceeding 3 sqm in area, deduction will be made in the measurements for the full opening of the wall treatment on both faces, while at the same time, jambs, sills and soffits will be measured for payment. In measuring jambs, sills and soffits, deduction shall not be made for the area in contact with the frame of doors, windows etc.

11.1.13 Mortar / Plaster Spraying Machine

11.1.13.1 Description

The Mortar Spraying Machine is a concrete spraying device that provides a great solution for construction sites since it needs a small number of workers and is twice or three times faster than conventional laborer.

11.1.13.2 Equipment

Plastering spraying machine of approved quality and standard. Contractor will arrange a suitable machine after approval of Engineer in Charge.

11.1.13.3 Construction Requirements

Usage of mortar spraying pump should be as per the certified manual of manufacturer.

11.1.13.4 Measurement & Payment

Work done by mortar spraying machine should be measured in cubic feet and should be paid on per hour rental cost of pump.

11.2 Pointing

11.2.1 Description

This work shall consist of pointing on brick masonry walls, roofs & floors in accordance with these specifications.

11.2.2 Preparation of Surface

Before pointing old brickwork or new brickwork in mud, the joints shall be raked out with a hook (not hammer) to a depth of half an inch. If, for any reason, the joints in new brickwork in lime or cement are not struck as the work proceeds, they shall be raked out before the mortar sets. All earth and mortar dust coming out of the joints as a result of raking shall be washed off and the brickwork sufficiently watered. The face shall once again be washed just before starting pointing. The surface prepared in the manner described above shall be inspected by the Engineer-in-charge or his authorized subordinate, and shall be approved by one of them before actual pointing begins.

11.2.3 Application Process

- The surface of the work is prepared as explained under "plastering". When commencing masonry on the next day, it is a must to rake out the face joints of all masonry finished on the previous day (24hours) to a depth of ½-inch; cleaned and wetted for the purpose of pointing. The work pointed is kept wet for at least 3-days. There are about half a dozen types of pointing, but the most common are the Struck, flush, weathered and grooved or ruled.
- For struck pointing the mortar shall be, filled in the joints flush with masonry with a pointing trowel and then pressed with proper pointing tools to form weathered and struck horizontal joints and triangular and V notched triangular joints.
- For flush pointing, after pressing mortar in the joints, these shall be finished level with edges. Flush pointing is used for floors and all vertical and horizontal joints in walls which are to be subsequently white washed or colour washed.
- Weathered pointing is used for horizontal joints; and grooved pointing is for vertical joints of walls.
- After pointing, the face of the work shall be cleared of all surplus mortar. No washing shall be done till the time the pointing has set. All works shall be kept wet for 10 days and protected from extreme temperature and weather. All defects shall be treated at contractor's expenses.

Normally, pointing is done with mortar having the following mix ratios: -

	Cement	Sand	Lime Paste	Surkhi
Outside Work	1	1 - 3	----	----
	1/3	----	1	1 - 2
	----	1	1	1/2 - 1

Table 1, Mix Ratios (Chapter 11)

11.2.4 Measurements

Pointing shall be measured by the superficial area. The deduction shall be made for openings of any size from one side only, whether pointing is done on one or two sides. The unit of measurement shall be 100 square feet or one sq. meter.

11.2.5 Rates

Contractor should be paid on the basis of work done under item number 11.2 after proper on site measurements and approval of the Engineer.

11.3 Whitewashing

11.3.1 Preparation and Application Process

a. Preparation of Material

All Works under this Heading shall conform to BS-CP-231. Lime shall conform to chapter-3 of Book-1 of these specifications on "Lime".

Whitewash, prepared from pure fat lime (white stone) or shell lime, preferably unslaked, is brought to the site of work and slaked there in a tank or tub of water for about 24 to 48 hours and then stirred up with a pole till it attains the consistency of a thin cream. Where necessary, gum or rice water (2 Oz. of gum for 1 cft of lime) is added. Sometimes flour, skimmed milk, glue, molasses or other substances are mixed in the slaked lime to increase its adhesion. Preservatives such as salt or formaldehyde are added to keep these substances from spoiling. Whitewash may be tinted by using pigment and should be strained through a coarse cloth or a line wire gauze before use.

b. Preparation of Surface

All loose material and dirt on the surface must be removed with a brush. Holes and irregularities of surface shall be repaired with lime putty, and the surface allowed drying before applying whitewash. Similarly, dusting and repair may be done to wall which have been whitewashed several times before. All greasy spots are given a coat of rice, water and sand. Surface discoloured by smoke are washed with a mixture of wood ashes and water or yellow earth before being whitewashed.

Cement concrete surface shall be scrapped off with a wire brush to remove greasy patches, if any, and washed with soap-suds. The surface shall be rinsed with water to remove traces of alkali. A coat of sodium silicate and water in the ratio 1:5 shall be given on the entire concrete surface to avoid future scaling or flaking off. Half to one-part (by weight) of tallow in small lumps shall be added to 16 parts of quick lime, slaking it with only just sufficient water to form a thick paste, stirring occasionally and allowing it to stand till it cools down. The paste shall then be thinned down to required consistency by adding water; and shall be strained and applied to surface.

11.3.2 Application

Each coat of whitewash shall comprise four strokes applied in each direction. The first coat shall be done in two directions either horizontally or vertically, and when the coat dries up, the second coat shall be applied in the remaining two directions. The next coat shall not be applied unless the previous one has dried up. Normally three coats shall be applied on the new surface. A dry coat shall not show any sign of cracking otherwise it shall be redone at the cost of the contractor. The whitewash, when dried, shall not come off readily on fingers when rubbed.

White wash, when completed, shall form an opaque coat of uniform white colour, through which the old work does not show and shall present a smooth regular surface free from powder

matter. If the surface is not in acceptable condition, the contractor shall provide additional coats at his own cost.

11.3.3 Measurements

All the works under this Heading shall be measured by actual area over which the treatment is applied. Deduction shall be made for the opening of any size from the two sides. The unit of measurement shall be square-foot and should be paid accordingly.

11.4 Cement Wash

11.4.1 Description

Colour-washing is nothing more than a lime-wash coloured with suitable pigments and treated to give a desired tin. It shall be applied exactly in the same fashion as the white wash. The old paint is scraped off and a coat of whitewash is applied before the new colour is given. Gum or rice water is added as, in whitewashing. Only such quantity of wash shall be prepared which can be consumed in a day.

11.4.2 Application

The surface shall be given a coat of whitewash prior to colour-wash. Each coat of colour-wash shall be allowed to dry and shall be inspected by the Engineer in Charge. The next coat shall not be applied unless the previous coat is approved by him. The first coat of whitewash and colour-wash coats shall be applied with brush. Each coat shall consist of four strokes one in each direction. The completed wall shall be of uniform colour, free from bolts, lines or cut shades and shall present a smooth regular surface which shall neither crack nor come off readily on fingers when rubbed. Each coat shall be finished in one operation and work shall not start in a room so late that it cannot be finished the same day. One coat of whitewash and two coats of colour-wash shall be sufficient. If the surface is still not in acceptable condition, the contractor shall apply additional coats of colour-wash at his own cost.

All floors, doors, windows and other articles etc. shall be properly protected from whitewash and cleaned after completion of work.

11.4.3 Other Respect

In all other respects, not specified here, it shall strictly conform to 11.3.

11.4.4 Measurements

All the works under this Heading shall be measured by actual area over which the treatment is applied. Deduction shall be made for the openings of any size from the two sides. The unit of measurement shall be % square-foot or square-meter as given in BOQ. Payment shall be made under the relevant BOQ item.

11.4.5 Rates

The unit rate shall include:

11.4.5.1 Labour Rate

When only labour rate is to be paid.

- (a) The preparation of surface and whitewash as per Heading 11.3.1 (b) and 11.3.3 of these specifications.
- (b) The provision, erection and removal of scaffolding and ladders (shot with gunny bags at both ends to prevent damage to the floor and walls).
- (c) The protection of floor, fixed furniture, doors and windows, as well as all such places and things as are not to be whitewashed. These places and things shall be protected from all droppings and slashes of whitewash, if any, and cleaned.
- (d) Provision of all tools and brushes required for whitewashing.

11.4.5.2 Composite Rate

When rate for completed job is to be paid, it includes all items mentioned in Heading 11.4.5.1 and cost of all material used at site of work in whitewashing.

11.5 Color Washing

Colour-washing is nothing more than a lime-wash coloured with suitable pigments and treated to give a desired tin. It shall be applied exactly in the same fashion as the white wash. The old paint is scraped off and a coat of whitewash is applied before the new colour is given. Gum or rice water is added as, in whitewashing. Only such quantity of wash shall be prepared which can be consumed in a day.

11.5.1 Application Process

The surface shall be given a coat of whitewash prior to colour-wash. Each coat of colour-wash shall be allowed to dry and shall be inspected by the Engineer in Charge. The next coat shall not be applied unless the previous coat is approved by him. The first coat of whitewash and colour-wash coats shall be applied with brush. Each coat shall consist of four strokes one in each direction. The completed wall shall be of uniform colour, free from bolts, lines or cut shades and shall present a smooth regular surface which shall neither crack nor come off readily on fingers when rubbed. Each coat shall be finished in one operation and work shall not start in a room so late that it cannot be finished the same day. One coat of whitewash and two coats of colour-wash shall be sufficient. If the surface is still not in acceptable condition, the contractor shall apply additional coats of colour-wash at his own cost.

All floors, doors, windows and other articles etc. shall be properly protected from whitewash and cleaned after completion of work.

11.5.2 Measurements

Whitewashing shall be measured by superficial area. The deduction shall be made for openings of any size from one side only, whether whitewashing is done on one or two sides. The unit of measurement shall be 100 square feet of one sq. meter.

11.5.3 Rates

11.5.3.1 Labour Rate

When only labour rate is to be paid.

- (a) The preparation of surface and wash as per 11.3.1 of these specifications.
- (b) The provision, erection and removal of scaffolding and ladders (shot with gunny bags at both ends to prevent damage to the floor and walls).
- (c) The protection of floor, fixed furniture, doors and windows, as well as all such places and things as are not to be whitewashed.
- (d) These places and things shall be protected from all droppings and slashes of whitewash, if any, and cleaned.
- (e) Provision of all tools and brushes required for whitewashing.

11.5.3.2 Composite Rate

When rate for completed job is to be paid, it includes all items mentioned in 11.5.3.1 and cost of all material used at site of work in whitewashing.

11.6 Vinyl Emulsion

The work shall consist of furnishing and applying vinyl emulsion on a surface in accordance with these specifications.

11.6.1 Materials

Vinyl emulsion manufactured by the approved manufacturers shall be used.

11.6.2 Preparation of Surfaces

- (a) Newly-plastered surface, when absolutely dry, shall be sandpapered to remove all irregularities, making good inequalities and holes with gypsum, which shall be allowed to set hard. Unless the surface is perfectly clean and smooth, no pleasing effect shall result from vinyl emulsion.
- (b) Old plastered surfaces shall be thoroughly cleaned. If it is whitewashed or colour-washed, it shall be rubbed off with sand-paper or cocoanut fiber in case it is loose and then stopped and sized.
- (c) After rubbing and cleaning, all plastered surface, old or new, shall be sized with a coat of equal parts of size and alum dissolved in hot water. Decomposed size shall not be used under any circumstances. Where the makers of the vinyl emulsion recommend a special priming coat only that coat shall be applied.
- (d) If the existing surface is cleanly vinyl emulsioned all the vinyl emulsion shall not necessarily be removed. The surface shall be smoothed down with glass paper and any firm vinyl emulsion that remains on the wall after such rubbing shall be left.

11.6.3 Mixing and Application

Vinyl emulsion mix shall be prepared strictly in accordance with the maker's instructions or as directed by the Engineer-in-charge, and the quantity shall be just sufficient for the day's work.

- (a) Vinyl emulsion shall be applied only with proper brushes. The brushes shall be washed in hot water after each day's work and hung up to dry. Old brushes caked with dry emulsion mix shall not be allowed to be used on the work.
- (b) Vinyl emulsion shall be applied quickly and boldly leaving no dry edges. The brush shall be dipped in emulsion and stroked cross-wise on the wall, then immediately stroked up and down and stopped.
- (c) Unless otherwise or directed two men shall work on wall together, one working from the ceiling downwards as far as he can reach and the other following him applying the vinyl emulsion from below. No patchy overlap shall be allowed under any circumstances.
- (d) On newly-plastered walls two coats over one coat of priming shall be applied.
- (e) On old walls covered with one or two coats of hard dry whitewash free from efflorescence or kalar, one coat without priming coat shall be applied.
- (f) The consumption of emulsion should be in accordance with spreading power as prescribed by the manufacturer.

11.6.4 Measurements

Whitewashing shall be measured by superficial area. The deduction shall be made for openings of any size from one side only, whether whitewashing is done on one or two sides. The unit of measurement shall be 100 square feet of one sq. meter.

11.6.5 Rates

The unit rate shall include:

11.6.5.1 Labour Rate

When only labour rate is to be paid.

- (a) The preparation of surface as per Heading 11.6.2 of these specifications.
- (b) The provision, erection and removal of scaffolding and ladders (shot with gunny bags at both ends to prevent damage to the floor and walls).
- (c) The protection of floor, fixed furniture, doors and windows, as well as all such places and things as are not to be whitewashed. These places and things shall be protected from all droppings and slashes of whitewash, if any, and cleaned.
- (d) Provision of all tools and brushes required for whitewashing.

11.6.5.2 Composite Rate

When rate for completed job is to be paid, it includes all items mentioned in Heading 11.6.5.1 and cost of all material used at site of work in whitewashing.

11.7 Plastic Emulsion

The work shall consist of providing, furnishing and applying plastic emulsion on a surface in accordance with these specifications.

11.7.1 General

Emulsions consist of a polymer latex, a plasticizer, a stabilizer and thickening agent, together with colouring pigments. Paints of this kind are used internally for decorating non-absorbent surfaces such as tone-plaster, or cement-asbestos sheeting. Occasionally they are used on wood but not on metal. They are easily applied by brush or roller but are not suitable for external use. The most commonly used plastic emulsion paints are polyvinyl acetate (PVA) based; PVA being a synthetic, resin. They range from matt to oil-gloss finish; the flat and egg-shell gloss types being best for damp walls since the glossier types are apt to blister if used in this way. All PVA based paints will resist alkali attack; they are, however, acid in the liquid state and, may, therefore, foster the corrosion of iron and steel. For this reason, these paints should not be used in steel paint kettles. They work easily, are free from persistent smell while drying and dry rapidly. They are not suitable, for situation where maximum protective action is required. The paint in the can will not withstand frost and in this respect resembles distemper. They can be washed from 3 to 7 days after application. The best surfaces on which to apply them are brick, retarded semi-hydrate plaster or renderings, softer surfaces such as ungauged lime plaster or smooth hard surfaces such as highly-troweled Keene's cement are likely to cause trouble and special primers should be used in such cases. Further notes on emulsion paints are given below:

- (a) Paints of this kind should not be applied to soft or friable surfaces such as old lime plasters or lime washes; even more care is needed in the preparation of such surfaces than is necessary with oil-gloss paints. Emulsion paints are not recommended for use in situations where condensation may occur such as in kitchens and bathrooms nor on highly troweled smooth plasters.
- (b) Emulsion paints will not adhere to oily or greasy surfaces.

- (c) The use of such paints on difficult surfaces may be facilitated by the use of a suitable oily primer.
- (d) Some emulsion paints are not suitable for external use on brickwork or renderings although polyvinyl acetate (PVA) emulsion paints can sometimes be so used in off-white or fawn colours showing some sheen; they should only be applied in very dry weather.
- (e) Certain emulsion paints can be applied to notoriously difficult surfaces such as asbestos cement sheeting's and some of the PVA variety can ' even be applied over old hard bituminous coatings.
- (f) The probable life of these paints on exterior surfaces is intermediate between that of oil bound distempers (shortest) and oil-gloss paints (longest); used internally, the life of emulsion paints should equal that of normal oil paints.

11.7.2 Preparation of Surfaces

- (a) Newly-plastered surface, when absolutely dry, shall be sandpapered to remove all irregularities, making good inequalities and holes with gypsum, which shall be allowed to set hard. Unless the surface is perfectly clean and smooth, no pleasing effect shall result from plastic emulsion.
- (b) Old plastered surfaces shall be thoroughly cleaned. If it is whitewashed or colour-washed, it shall be rubbed off with sand-paper or coconut fiber in case it is loose and then stopped and sized.
- (c) After rubbing and cleaning, all plastered surface, old or new, shall be sized with a coat of equal parts of size and alum dissolved in hot water. Decomposed size shall not be used under any circumstances. Where the makers of the plastic emulsion recommend a special priming coat only that coat shall be applied.
- (d) If the existing surface is cleanly plastic emulsioned all the plastic emulsion shall not necessarily be removed. The surface shall be smoothed down with glass paper and any firm plastic emulsion that remains on the wall after such rubbing shall be left.

11.7.3 Mixing and Application

Plastic emulsion mix shall be prepared strictly in accordance with the maker's instructions or as directed by the Engineer-in-charge, and the quantity shall be just sufficient for the day's work.

- (a) Plastic emulsion shall be applied only with proper brushes. The brushes shall be washed in hot water after each day's work and hung up to dry. Old brushes caked with dry emulsion mix shall not be allowed to be used on the work.
- (b) Plastic emulsion shall be applied quickly and boldly leaving no dry edges. The brush shall be dipped in emulsion and stroked cross-wise on the wall, then immediately stroked up and down and stopped.
- (c) Unless otherwise or directed two men shall work on wall together, one working from the ceiling downwards as far as he can reach and the other following him applying the plastic emulsion from below. No patchy overlap shall be allowed under any circumstances.
- (d) On newly-plastered walls two coats over one coat of priming shall be applied.
- (e) On old walls covered with one or two coats of hard dry whitewash free from efflorescence or kalar, one coat without priming coat shall be applied.
- (f) The consumption of emulsion should be in accordance with spreading power as prescribed by the manufacturer.

11.7.4 Other Respects

In all other respects, not specified here, it shall strictly conform to Heading 11.3.

11.7.5 Measurements

Whitewashing shall be measured by superficial area. The deduction shall be made for openings of any size from one side only, whether whitewashing is done on one or two sides. The unit of measurement shall be 100 square feet of one sq. meter.

11.7.6 Rates

The unit rate shall include:

11.7.6.1 Labour Rate

When only labour rate is to be paid.

- (a) The preparation of surface as per Heading 11.7.2 of these specifications.
- (b) The provision, erection and removal of scaffolding and ladders (shot with gunny bags at both ends to prevent damage to the floor and walls).
- (c) The protection of floor, fixed furniture, doors and windows, as well as all such places and things as are not to be whitewashed. These places and things shall be protected from all droppings and slashes of whitewash, if any, and cleaned.
- (d) Provision of all tools and brushes required for whitewashing.

11.7.6.2 Composite Rate

When rate for completed job is to be paid, it includes all items mentioned in Heading 11.7.6.1 and cost of all material used at site of work in whitewashing.

Sieve size	Perlite, Natural and Manufactured Sand			
	Volume %		Weight %	
	Max	Min	Max	Min
No. 20 (850 µm)	0	--	0	--
No. 30 (600 µm)	10	--	0.5	--
No. 100 (150 µm)	100	40	100	40
No. 200 (75 µm)	100	70	100	70

Table 2, Aggregate for Finish Coat Plasters, Percentage Retained on Each Sieve, Cumulative (Chapter 11)

Sieve Size	Max	Min
No. 16 (1.18 mm)	0	0
No. 30 (600 µm)	50	20

No. 50 (300 µm)	70	50
No. 100 (150 µm)	100	80

Table 3, Sand for Job-Mixed Lime Putty-Gypsum Gaged Sand Float Finish, Percent Retained on Each Sieve by Weight, Cumulative (Chapter 11)

Plaster Base	Aggregates		
	Sand		Perlite or Vermiculite
	By volume, ft ³ (m ³), Damp and Loose	By weight, lb. (kg), Damp and Loose	By volume, ft ³ (m ³)
Over Gypsum Lath			
Two-Coat work:			
Base coat	2 ½ (0.071)	250 (113)	2 (0.06)
Three-coat work			
Scratch coat	2 (0.056)	200 (91)	2 (0.06)
Brown coat	3 (0.085)	300 (136)	2 (0.06)
Or			
Scratch and Brown coats Over metal lath	2 ½ (0.071)	250 (113)	-----
Three-coat work:			
Scratch coat	2 (0.058)	200 (91)	2 (0.06)
Brown coat	3 (0.085)	300 (136)	
Or			
Scratch and Brown coats Over unit Masonry (Note 6)	2 ½ (0.071)	250 (113)	-----
Two Coat work			
Base coat	3 (0.085)	300 (136)	3 (0.085)
Three-coat work			
Scratch coat	3 (0.085)	300 (136)	3 (0.085)
Brown coat	3 (0.085)	300 (136)	3 (0.085)
Over Monolithic Concrete			
For base coat properties applicable to monolithic concrete,			

Table 4, Base Coat Proportions (Chapter 11)

Proportions of Fine Aggregate		
Not Less Than	Not More Than	Per
½ ft ³ (0.014 m ³)	1 ft ³ (0.028 m ³)	100 ft ³ (45.4 kg) gypsum gauging
or 1/8 ft ³ (0.0035 m ³)	¼ ft ³ (0.007 m ³)	1 lb. (22.7 kg) dry hydrated lime
or 1 U.S. gal (3.78 L)	2 U.S. gal (7.57 L)	1 ft ³ (0.028 m ³) lime putty
or 1 pt. (0.473 L)	1 pt. (0.946 L)	1 U.S. gal (3.78 L) lime putty

Table 5, Trowel Finishes of Lime Putty Gaged with Gypsum Gaging Plaster Proportions (Chapter 11)

Plaster Base	Thickness of Plaster Including Finish Coat, in. (mm)
Metal plaster base	5/8 (16) min
All other types of plaster base	1/2 (13) min
Unit masonry	5/8 (16) min
Monolithic concrete surfaces:	
Vertical	5/8 (16) min
Horizontal	1/8 (3) to 5/8 (10)

Table 6, Thickness of Plaster (Chapter 11)

11.8 Distemping

11.8.1 General

- Unless otherwise specified or directed in writing, a newly plastered wall shall not be distemped earlier than 12 months after the plastering if distemped earlier the plaster shall be treated with damp proof compound.
- Distemping shall not be done in damp weather nor when the weather is excessively hot and dry.

11.8.2 Preparation of Surface

- Newly-plastered surface when absolutely dry shall be sand-papered to remove all irregularities, making good inequalities and holes with gypsum which shall be allowed to set hard. Unless the surface is perfectly clean and smooth, no pleasing effect shall result from distemper.
- Old plastered surfaces shall be thoroughly cleaned if it is whitewashed or colorwashed, it shall be rubbed off with sand-paper or cocoanut fiber in case it is loose and then stopped and sized.
- After rubbing and cleaning, all plastered surface, old or new, shall be sized with a coat of equal parts of size and alum dissolved in hot water. Decomposed size shall not be used under any circumstances. Where the makers of the distemper recommend a special priming coat only that coat shall be applied.
- If the existing surface is cleanly distemped all the distemper shall not necessarily be removed. The surface shall be smooth down with glass paper or any firm distemper on the wall after such rubbing shall be-left.

11.8.3 Preparation of Distemper

- Unless otherwise specified ready-made distempers as specified and approved by the Engineer-in-Charge shall be obtained from the market as they are easily available.
- Distempers shall be mixed strictly in accordance with the maker's instructions or as directed by the Engineer-In-charge, and the quantity shall be just sufficient for the day's work.

11.8.4 Application

- Distemper shall be applied only with proper brushes as supplied or recommended by the maker. The brushes shall be washed in hot water after work each day and hung up to dry. Old brushes caked with dry distemper shall not be allowed to be used on the work.

- Distemper shall be applied quickly and boldly leaving no dry edges. The brush shall be dipped in distemper and stroked cross-wise on the wall, then immediately stroked up and down and stopped.
- Unless otherwise specified or directed two men shall work on a wall together, one working from the ceiling, downwards as far as he can reach and the other following him applying, the distemper from below. No patchy overlap shall be allowed under any circumstance.
- Unless otherwise specified, the following number of coats of distempers shall be applied: -
 - On newly plastered walls two coats over one coat of priming.
 - On old plastered walls covered with one or two coats of hard dry whitewash free from efflorescence or kalar, one coat without priming coat.

11.8.5 Measurement

- Length and breadth shall be measured correct to a cm. and area shall be calculated in sqm correct to two places of decimals. Measurements for Jambs, Soffits and Fills etc. for openings shall be as described 11.1.12.1
- Cornices and other such wall or ceiling features, shall be measured along the girth and included in the measurements.
- The number of coats of each treatment shall be stated. The item shall include removing nails, making good holes, cracks, patches etc. not exceeding 50 sq. cm. each with material similar in composition to the surface to be prepared. Work on old treated surfaces shall be measured separately and so described.

11.9 Wall Covering / Architectural Covering

11.9.1 Description

This specification covers the performance, quality, packaging, and marking characteristics of flexible wall covering as a finished product.

11.9.2 Definition

11.9.2.1 Wallcovering

A flexible product designed to cover walls and ceilings for decorative or functional purpose, or both.

11.9.2.2 Backing (Substrate)

Material upon which facing (or an intermediate layer) is applied. Backing is that material which is adhered to the wall.

11.9.2.3 Bias

Pattern running off true horizontal or vertical plane.

11.9.2.4 Bolt

A continuous amount of packaged material containing the amount specified on the label

11.9.2.5 Facing

Decorative material which is applied to an intermediate layer or backing.

11.9.2.6 Finished product

Wallcovering offered to a consumer for installation.

11.9.2.7 Intermediate layer

Material, if any, between the facing and the backing.

11.9.2.8 Lob (batch)

The product from a continuous manufacturing run having the same appearance and characteristic from beginning to end.

11.9.2.9 Pattern match

The meeting of all parts and colours of a pattern at the seams of adjacent strips.

11.9.2.10 Pattern Repeat

The vertical distance between adjacent match points of a pattern.

11.9.2.11 Protective layer

Any material applied to the facing to enhance performance.

11.9.2.12 Register

The designed meeting of all parts and colors of a pattern.

11.9.2.13 Run

A unit of production which may include more than one lot.

11.9.2.14 Seconds

Finished material not meeting the quality criteria in accordance with Classification F 793 and this specification.

11.9.2.15 Selvage

An undecorated edge which must be trimmed away to allow for correct pattern match or uniform continuity of color.

11.9.2.16 Waste edge

A decorated edge that must be trimmed away to allow for correct pattern match or uniformity of color.

11.9.2.17 Shading

Color variation – difference within the same lot of wallcovering.

Luster variation – difference in gloss level within the same lot of wallcovering.

Texture variation – difference in embossing within the same lot of wallcovering.

11.9.2.18 Split bolt

A bolt consisting of two or three separate lengths of material.

11.9.3 Appearance

There shall be no appreciable difference in shading except on those finished products in which natural decorative characteristics are being simulated. These variances must be clearly stated in writing at the point of purchase. To determine whether there is an appreciable difference, suspend three sequential 8-ft (2.4-m) strips at eye level in a vertical position, as on the wall, under illumination be between 100 to 150 fc (1000 to 1500 lx), and view the strips from a distance between 4 and 8 ft (1.2 and 2.4m). An appreciable difference is one which is noticeable when one strip is compared with the others.

11.9.4 Wall Preparation and Installation

- Basic and correct wall preparation instructions, with particular attention to wall covering which requires special wall preparation for its proper installation, shall be included in sample books and installation instructions.
- Installation instructions shall be in or with each bolt and be readily accessible to the installer. It shall be the manufacturer's responsibility to notify consumers of proper installation techniques when new products are introduced.
- The manufacturer shall recommend an adhesive, when necessary, and the products to be used for wall preparation. Recommendation for alternative adhesives and wall preparation products shall be included in the installation instructions.

11.9.5 Physical Requirements

- Each finished product shall be uniform in physical properties, in accordance with Classification ASTM F 793 and this specification.
- All facing and protective layers shall be adhered properly to backings and intermediate layers and the finished product shall be of such quality that delamination does not occur during normal installation and use.
- Finished products shall not chip, peel, or flake during normal installation and use. (For test methods to determine conformity with this requirement refer to Classification ASTM F 793).
- There shall be not more than a 1/8-in. (3.5-mm) variance in pattern match between two 8-ft (2.4-m) strips at midpoint.
- Wallcovering shall be free from all surface flaws, creases, splices, scratches, tears and dirt throughout its entire length.
- Wallcovering shall be free of wrinkles which cannot be removed in the course of normal installation.
- Finished product shall not shrink or expand after installation when installed in accordance with the manufacturer's instructions.
- Pretrimmed material shall be trimmed so that no contracting backing color will show at the seam when two sheets are properly installed.
- Pretrimmed material shall show no frayed or wavy edges.
- All elements of the pattern shall be in register.
- The design shall be set at an angle of 90° to the trimmed edge.
- Split bolts narrow goods shall have no piece shorter than 9 ft (2.7m) and shall have an area at least 10% larger than specified on the label. Three lengths are permitted in split bolts having an area exceeding 100 ft² (9.3m²). wide commercial goods shall have no piece shorter than 3 yd (2.7m) and one-half linear yard larger than specified on the label.
- The finished product shall have the necessary characteristics to adhere the product to the wall when it is installed in accordance with the manufacturer's instructions. (For test methods to determine conformity with this requirement refer to Classification ASTM F 793).

11.9.6 Rejection and Review

- Wallcovering that fails to conform to the requirements of this specification may be rejected by the installer or purchaser. Rejections shall be reported to the supplier promptly in person, by phone, or in writing, or any combination thereof. In the event the supplier is unwilling or unable to satisfy the complainant, the matter should be referred to the manufacturer. The inspection and test procedures contained in this specification shall be used to determine the conformance of the product to the

requirements of this specification. Each manufacturer who represents a product as conforming to this specification may use statistically based sampling plans that are appropriate for each particular manufacturing process, but shall keep such essential records as are necessary to documents the claim that the requirements of this specification have been met.

- Any portion of the item not conforming to this specification shall be clearly marked as seconds if packaged for resale at retail.

11.9.7 Measurement

Wallcovering/Architecture Coating shall be measured by superficial area. The unit of measurement shall be 100 square feet.

11.9.8 Rate

The unit rate shall be full compensation for all costs or complying with the provision of this section and as directed by the Engineer-in-charge.

	Dry						Lime Putty Wet Equivalent		
	Weight. lb (kg)			Volume, ft3 (m3)			ft3 (m3)	U.S. gal	lb (kg)
	Gypsum	Lime	Aggregate	Gypsum	Lime	Aggregate	(litres)		
Troweled Finishes: ^A									
Lime putty with: ^B									
Gypsum gauging	100 (45.4)	225 (102)	0 ^A	1 (.028)	3 (.085)	0	6.75 (.191)	52.5 (199)	450 (204)
Gypsum Keene's cement:									
Medium	100 (45.4)	50 (22.7)	0 ^A	1 (.028)	1 (.028)	0	1 ¹ / ₈ (.032)	8 ³ / ₄ (33)	100 (45.4)
Hard	100 (45.4)	25 (11.3)	0 ^A	1 (.028)	1/2 (.014)	0	5/8 (.018)	4 1/2 (17)	50 (22.7)
Ready-mixed gypsum plaster	100 (45.4)	0	0	1 (.028)	0	0	0	0	0
Gypsum vermiculite	100 (45.4)	0	7 to 15 (32 to 6.8)	1 (.028)	0	1 (.028)	0	0	0
Floated Finishes:									
Lime putty with: Gypsum gauging	100 (45.4)	255 (102)	200 (90.7)	1 (.028)	3 (.028)	2 (.057)	6.75 (.191)	52.5 (199)	450 (204)
Gypsum Keene's cement									

Medium	150 (68.0)	100 (45.4)	450 (204)	1 ½ (.042)	2 (.057)	4 ½ (.127)	2 ¼ (.064)	17 ½ (66)	200 (90.7)
Ready-mixed gypsum Plaster ^C	100 (45.4)	0	0	1 (.028)	0	0	0	0	0
Gypsum-vermiculite	100 (45.4)	0	7 to 15 (32 to 6.8)	1 (.028)	0	1 (.028)	0	0	0
Gypsum-sand (job-mixed) ^D	100 (45.4)	0	200 (90.7)	1 (.028)	0	2 (.057)	0	0	0

Table 7, Proportion of Gypsum to Not More than Lime/Aggregate, with Dry and Wet Equivalent (Chapter 11)

- A If additional hardness of finish coat is desired, increased amounts of gypsum shall be used; however, hard finishes shall not be used over lightweight aggregate base coats.
- C Mixed with water only, in accordance with manufacturers' printed directions.
- D Gypsum shall be neat, un-fibred plastered.

11.10 Stucco Cement Plaster

11.10.1 Scope

It shall cover placing 1:2:4 (Cement, Sand and Shingle) mix, 51 mm thick, as a plaster including furnishing of all labor, materials, plant, equipment, accessories and services as required to complete the plastering item as shown on the Drawings, specified herein and/or as directed by the Engineer-in-Charge. The materials herein specified shall be proportioned, mixed, formed and placed in accordance with the herein stated requirements. The stipulations and requirements herein set forth shall apply except when such stipulations and requirements are specifically modified by the Engineer for this particular item of work.

11.10.2 Materials

11.10.2.1 Cement

Portland cement shall conform to ASTM C 150-94 Type 1 or BSS-12.

11.10.2.2 Sand

All sand required under these specifications shall be composed of particles with a maximum size of 5 mm. Sand shall be processed from natural deposits or manufactured from quarried rock. The grading of sand for this item of work shall be as under: -

- 100 % shall pass through sieve NO.4
- 2 to 10% shall pass through sieve NO.100

11.10.2.3 Aggregate

The aggregate shall comprise shingle having grading as shown on the Drawings and or as directed by the Engineer. Generally reasonable grading is as under: -

- | | |
|--------------------|------------|
| ➤ 5mm to 9mm size | up to 25% |
| ➤ 9mm to 10mm size | up to 75%. |
| ➤ Above 18mm | Nil |

11.10.2.4 Water

Water required to be used shall conform to the stipulations and requirements set-forth for Brickwork mortar.

11.10.3 Mix Preparation

The mix shall conform to the mix design specified in the Drawings. Mix used in Stucco Cement Plastering, as a general principle, shall be so mixed that it is firm enough to stay in place when plastered. The net water-cement ratio of the concrete (exclusive of water within or absorbed by the aggregates) shall range from 0.53 to 0.58 based on the climatic temperature. Temperature of mix when it is placed, shall not be more than 32-degree C and not less than 5-degree C. Tests of the mix shall be made by the Engineer-in-Charge and the mix proportions shall be changed, whenever necessary, for the purpose of securing the required workability, density, impermeability, durability or strength.

11.10.4 Thickness

Unless otherwise specified, the thickness of the plaster shall conform to the approved design/ drawings. Generally, the thickness of Stucco cement plaster is taken as 51 mm. The plaster having thickness less than the specified thickness shall be rejected.

11.10.5 Application of Plaster

The plaster shall be done in two coats. The surface of first coat shall be made rough before the second coat is applied.

11.10.6 Measurement

- Length and breadth shall be measured correct to a cm. and area shall be calculated in sqm correct to two places of decimals. Measurements for Jambs, Soffits and Fills etc. for openings shall be as described in 11.1.12.1.
- Cornices and other such wall or ceiling features, shall be measured along the girth and included in the measurements.
- The item shall include removing nails, making good holes, cracks, patches etc. not exceeding 50 sq. cm. each with material similar in composition to the surface to be prepared. Work on old treated surfaces shall be measured separately and so described.

11.11 Alucobond (Face Cladding)

Also commonly referred to as "Diabond" or "ACM", aluminum composite panels consist of two aluminum cover sheets and a core made of low-density polyethylene.

The cladding system shall be installed complete by an approved specialist cladding subcontractor with a demonstrated experience of at least 10 years in the fabrication and installation of cladding systems. All work to be carried out in accordance with manufacturer's recommendations and approval of Engineer-in-Charge.

11.11.1 References**11.11.1.1 Aluminum Association**

- AA-M12C22A41: Anodized - Clear Coating
- AA-M12C22A44: Anodized - Color Coating

11.11.1.2 American Architectural Manufacturers Association

AAMA 508-05 Voluntary Test Method and Specification for Pressure Equalized Rain Screen Wall Cladding Systems

11.11.1.3 American Society for Testing & Materials

E 330	Structural Performance of Exterior Windows, Curtain Walls, and Doors under the Influence of Wind Loads
E 283	Rate of Leakage through Exterior Windows, Curtain Walls, and Doors
D 1781	Climbing Drum Peel Test for Adhesives
E 84	Surface Burning Characteristics of Building Materials
D 1929	Standard Test for Ignition Properties of Plastics
D 3363	Method for Film Hardness by Pencil Test
D 2794	Resistance of Organic Coatings to the Effects of Rapid Deformation (Impact)
D 3359	Methods for Measuring Adhesion by Tape Test
D 2247	Practice for Testing Water Resistance of Coatings in 100% Relative Humidity
B 117	Method of Salt Spray (Fog) Testing
D 2244	Calculation of Color Differences from Instrumentally Measured Color Coordinates
D 4214	Evaluating the Degree of Chalking of Exterior Paint Films
D 822	Practice for Operating Light and Water Exposure Apparatus (Carbon-Arc Type) for Testing Paint, Varnish, Lacquer, and Related Products
D 1308	Effect of Household Chemicals on Clear and Pigmented Organic Finishes

11.11.1.4 International Conference of Building Officials

NFPA 285 Intermediate Scale Multi Story Test

11.11.2 Samples Submittal

The contractor shall submit the technical guide, samples along with the construction drawing showing the panel arrangement to the Engineer-in-Charge. The samples shall fulfill the following criteria: -

- Panel System Assembly: Two samples of each type of assembly. 304mm (12") x 304mm (12") minimum.
- Two samples of each color or finish selected, 76mm (3") x 102mm (4") minimum.

11.11.3 Delivery, Storage and Handling

- Protect finish and edges in accordance with panel manufacturer's recommendations and as per directions of Engineer-in-Charge.
- Store material in accordance with panel manufacturer's recommendations and as per directions of Engineer-in-Charge.

11.11.4 Execution of Works

11.11.4.1 Inspection

- Surfaces to receive panels shall be even, smooth, sound, clean, dry and free from defects detrimental to work. The Engineer-in-Charge shall notify contractor in writing of conditions detrimental to proper and timely completion of the work. Do not proceed with erection until unsatisfactory conditions have been corrected.
- Surfaces to receive panels shall be structurally sound as determined by a registered Architect / Engineer.

11.11.4.2 Installation

- Erect panels plumb, level, and true.
- Attachment system shall allow for the free and noiseless vertical and horizontal thermal movement due to expansion and contraction for a material temperature range of -20°F to +180°F (-29°C to +82°C). Buckling of panels, opening of joints, undue stress on fasteners, failure of sealants or any other detrimental effects due to thermal movement will not be permitted. Fabrication, assembly, and erection procedure shall account for the ambient temperature at the time of the respective operation.
- Panels shall be erected in accordance with an approved set of shop drawings.
- Anchor panels securely per engineering recommendations and in accordance with approved shop drawings to allow for necessary thermal movement and structural support.
- Conform to panel fabricator's instructions for installation of concealed fasteners.
- Do not install component parts that are observed to be defective, including warped, bowed, dented and broken members.
- Do not cut, trim, weld, or braze component parts during erection in a manner which would damage the finish, decrease strength, or result in visual imperfection or a failure in performance. Return component parts which require alteration to shop for re-fabrication, if possible, or for replacement with new parts.
- Separate dissimilar metals and use gasketed fasteners where needed to eliminate the possibility of corrosive or electrolytic action between metals.

11.11.4.3 Adjusting and Cleaning

- Remove and replace panels damaged beyond repair as a direct result of the panel installation. After installation, panel repair and replacement shall become the responsibility of the General Contractor.

- Repair panels with minor damage.
- Remove masking (if used) as soon as possible after installation. Masking intentionally left in place after panel installation on an elevation, shall become the responsibility of the General Contractor.
- Any additional protection, after installation, shall be the responsibility of the General Contractor.
- Make sure weep holes and drainage channels are unobstructed and free of dirt and sealants.
- Final cleaning shall not be part of the work of this section.

11.11.5 Measurement and Payment

11.11.5.1 Measurement

- Length and breadth of the Alcobond shall be measured correct to a cm and the surface area worked out in square meter of the finished work.
- No deduction shall be made for openings of areas up to 40 square decimeters. No extra payment will be made for any extra material or labour involved in forming such openings. For openings exceeding 40 square decimeters in area, deduction for the full opening will be made, but no extra will be paid for any extra material or labour involved in forming such openings.
- Boarding fixed to curved surfaces in narrow widths shall be measured and paid for separately. Circular cutting and waste shall be measured and paid for separately.

11.11.5.2 Composite Rate

The measurement and payment for the items of the work of Finishes hereof shall be made corresponding to the applicable CSR items as provided in Contract Agreement and shall constitute full compensation, for procurement, transportation, performance in all respects and completion of work as specified including the site clearance as approved by the Engineer-in-Charge.

11.11.5.3 Labour Rate

The measurement and payment for the items of the work of Finishes hereof shall be made corresponding to applicable CSR item as provided in Contract Agreement and shall constitute full compensation for procurement transportation, performance in all respects and completion of work as specified including site clearance, as approved by the Engineer-in-Charge except the cost of materials to be provided by Department at designated location as defined in the Contract Agreement.

11.11.6 References

The following standards and standard specifications, referred to thereafter by designation only, form a part of these Specifications: -

- ASTM A446 / A446M-91, Specification for Steel Sheet, Zinc-Coated (Galvanized) by the Hot-Dip Process, Structural (Physical) Quality.
- ASTM A525-91b, Specification for General Requirements for Steel Sheet, Zinc-Coated (Galvanized) by the Hot-Dip Process.
- ASTM A641-92, Specification for Zinc-Coated (Galvanized) Carbon Steel Wire.

- C635-91, Specification for the Manufacture, Performance and Testing of Metal Suspension Systems for Acoustical Tile and Lay-In Panel Ceilings.
- C636-91, Practice for Installation of Metal Ceiling Suspension Systems for Acoustical Tile and Lay-In Panels.
- E84-91a, Test Method for Surface Burning Characteristics of Building Materials.
- E119-88, Method for Fire Tests of Building Construction Materials.
- E488-90, Test Method for Strength of Anchors in Concrete and Masonry Elements.
- E580-91 Practice for Application of Ceiling Suspension Systems for Acoustical Tile and Lay-In Panels in Areas Requiring Seismic Restraint.
- E. 95-92, Practice for Mounting Test Specimens during Sound Absorption Tests.
- E1190-87, Test Methods for Strength of Powder Actuated Fasteners Installed in Structural Members.
- EI 264-90, Classification of Acoustical Ceiling Products.

Contents

CHAPTER 12	WOODWORKS, WOODEN / ALUMINUM JOINERY	6
12.1	Wood work General	7
12.1.1	Glossary	7
12.1.2	Materials	22
12.1.3	Construction Requirements	28
12.1.4	Measurements	29
12.1.5	Rates and Payments	29
12.2	Doors and Windows	31
12.2.1	Construction Requirement	31
12.2.2	Measurement	34
12.2.3	Rates & Payments	34
12.3	Paneled and Glazed Doors and Windows	35
12.3.1	Construction Requirement	35
12.3.2	Measurement	36
12.3.3	Rates	36
12.4	Framed and Braced Doors and Windows	37
12.4.1	Construction Requirements	37
12.4.2	Measurements	37
12.4.3	Rates	37
12.5	Ledged and Braced Doors and Windows	38
12.5.1	Construction Requirements	38
12.5.2	Measurement	38
12.5.3	Rates	38
12.6	Ledged Doors and Windows	40
12.6.1	Construction Requirements	40
12.6.2	Measurements	40
12.6.3	Rates	40
12.7	Clerestory Windows	40
12.7.1	Construction Requirements	40
12.7.2	Measurements	41
12.7.3	Rates	41
12.8	Wire Gauzed Doors	41
12.8.1	Material Requirement	41
12.8.2	Construction Requirements	42

12.8.3	Measurements.....	42
12.8.4	Rates.....	43
12.9	Wire Gauzed Windows.....	43
12.9.1	Construction Requirements.....	43
12.10	Wire Gauzed Clerestory Windows.....	44
12.10.1	Construction Requirements.....	44
12.11	Fixed Wire Gauzed.....	45
12.11.1	Construction Requirements.....	45
12.11.2	Fixing Rates.....	45
12.12	Glazing.....	46
12.12.1	Construction Requirements.....	46
12.12.2	Measurement.....	47
12.12.3	Rates.....	47
12.13	Wooden Floors.....	47
12.13.1	Construction Requirements.....	47
12.13.2	Measurements.....	49
12.13.3	Rates and Payments.....	49
12.14	Wooden Joinery.....	50
12.14.1	Conformity to Standard.....	50
12.14.2	Materials.....	50
12.14.3	Workmanship.....	51
12.14.4	Painting.....	53
12.14.5	Measurement.....	53
12.14.6	Rates and Payments.....	54
12.15	Aluminum Joinery.....	55
12.15.1	Scope.....	55
12.15.2	General.....	55
12.15.3	Material Requirements.....	55
12.15.4	Workmanship.....	56
12.15.5	Product, Delivery and Storage.....	56
12.15.6	Protection and Cleaning.....	56
12.15.7	Defective Work.....	56
12.16	Cladding.....	58
12.16.1	Brick Cladding.....	58
12.16.2	Wash Terrazzo.....	59
12.16.3	Porcelain / Ceramic Tile Cladding.....	60

12.16.4	Cast Stone Cladding	61
12.17	Door Closers	63
12.17.1	Traffic Volume Considerations	63
12.17.2	Building Code Considerations	63
12.17.3	Aesthetic Considerations	64
12.17.4	Other Types of Door Closers	64
12.18	Door Lock System	65
12.18.1	Door Bolts	65
12.18.2	Fitting	65
12.18.3	Special Door Furniture	66
12.18.4	Screws	66
12.18.5	Chocks	66
12.18.6	Stops	66
12.18.7	Measurement	66
12.19	Miscellaneous	67
12.19.1	Butt Hinges	67
12.19.2	Mild Steel (Medium)	67
12.19.3	Cast Brass	68
12.19.4	Extruded Aluminium Alloy	68
12.19.5	Parliament Hinges	68
12.19.6	Spring Hinges (Single or Double Acting)	69
12.19.7	Continuous Piano Hinges	69
12.19.8	Tee Hinges	70
12.19.9	Sliding Door Bolts	70
12.19.10	Tower Bolts	70
12.19.11	Pull Bolt Locks	71
12.19.12	Door Latch	71
12.19.13	Indicating Bolt (Vacant/Engaged)	71
12.19.14	Mortice Lock and Latch	72
12.19.15	Mortice Latch (With Locking Bolt)	72
12.19.16	Mortice Lock and Latch (Rebated)	72
12.19.17	Mortice Night Latch	72
12.19.18	Cupboard or Wardrobe Lock	72
12.19.19	Kicking Plates	73
12.19.20	Door Handles (Doors and Windows)	73
12.19.21	Floor Door Stopper	73

12.19.22	Hanging Rubber Door	74
12.19.23	Universal Hydraulic Door Closer (Exposed Type).....	74
12.19.24	Hasp and Staple Safety Type	74
12.19.25	Finger Plate.....	75
12.19.26	Curtain/Traverse Rod	75
12.19.27	Guarantee.....	75
12.19.28	Measurements.....	75
12.19.29	Rates.....	76
12.20	Wooden Stairs.....	76
12.20.1	General.....	76
12.20.2	Workmanship	76
12.21	Wooden Roof.....	76
12.22	Sound Proof.....	76
12.23	Wall Lining	77
12.23.1	Measurements.....	77
12.23.2	Grounds.....	77
12.23.3	Paneling.....	77
12.24	U-PVC Doors & Window	77
12.24.1	Delivery, Storage and Protection	78
12.24.2	Environmental Requirements	78
12.24.3	Measurements.....	78
12.25	Kitchen Cabinets/Wardrobes/almirah.....	78
12.25.1	Construction requirements	78
12.25.1.5	Measurements.....	79
12.26	Aluminum Windows and Doors.....	80
12.26.1	Description.....	80
12.26.2	General Compliance	80
12.26.3	Material Requirements.....	80
12.26.4	Samples	81
12.26.5	Construction Requirements	82
12.26.6	Glazing	83
12.26.7	Measurement.....	83
12.26.8	Rate.....	83
12.28	Hand Rail	84
12.28.1	Material	84
12.28.2	Construction Requirements	84

12.28.3 Measurement and Payment	84
12.29 Trellis	85
12.30 Glass Block Masonry	85
12.30.1 Measurement	86
12.31 Polypropylene stacking chair	86
12.31.1 Measurement	86
12.32 Pre-fabricated Building	86
12.31.1 Measurement	86
ANNEXURE -1 TABLE FOR SIZES	87
ANNEXURE – 2 General Drawings/Cross section of Door & Windows	94
.....	95

CHAPTER 12 WOODWORKS, WOODEN / ALUMINUM JOINERY**References:**

Sr.#	Standard Name	Description
Chapter – 12		
BS		
1.	BS1455	Specification for Plywood Manufactured from Tropical Hardwoods.
2.	BS 3444	Gymnasium equipment. Specification of general requirements.
3.	B.S:1204	Specification for type MR phenolic and amino plastic synthetic resin adhesives for wood.
4.	B.S:745	Specification for animal glue for wood (joiner's glue) (dry glue; jelly or liquid glue)
5.	BS:1202	Specification for nails. Steel nails.
6.	BS: 1210	Specification for wood screws.
7.	BS-459	Paneled and Glazed Wood Doors
8.	BS-325	Specification for black cup and countersunk bolts and nuts.
9.	BS-916	Specification for Black bolts screws and nuts - Hexagon & Square, With B.S.W. Threads, and Partly Machined Bolts, Screws & Nuts, Hexagon & Square With B.S.W. or B.S.F. Threads.
10.	BS-1494	Specification for fixing accessories for building purposes. Fixings for sheet, roof and wall coverings.
11.	BS-544	Specification for linseed oil putty for use in wooden frames.
12.	BS-952	Glass for glazing. Classification.
13.	BS: CP-152	Glazing and fixing of glass for buildings
14.	BS: CP-151 Part-I	Doors and windows including frames and linings. Wooden doors.
15.	B.S. 4873	Aluminum alloy windows and door sets. Specification.
16.	BS 4315	Methods of test for resistance to air and water penetration. Permeable walling constructions (water penetration)
ASTM		
17.	ASTM B 303	Specification for Copper-Infiltrated Sintered Carbon Steel Structural Parts.
18.	ASTM B580 - 79.	Standard Specification for Anodic Oxide Coatings on Aluminum.

12.1 Wood work General

Wood work is the process of converting timber into a desired shape and erecting it into its final position. It is mostly carpenter's and joiner's work.

Carpenter's Work

Carpenter's work includes all work on timber used in roofs, floors, verandas, staircases, doors and windows, frames, bridges, centering, shores, struts, large gates, and generally all wood work of which the scantling exceeds $\frac{3}{4}$ th of an inch, except in case of battens used in roof trellis-works which is specially molded or carved.

When the thickness of carpenter's work does not exceed 2-inches but its width exceeds twice the thickness, it is called "planking".

Joiner's Work

Joiner's work includes furniture, doors and windows, turned, and carved, or moulded work of all kinds.

12.1.1 Glossary

A glossary of terms usually employed in wood work is given below:

Apron Lining:	A board used to form a finish at the edges of the floor around a stair well.
Architrave:	The trim to a door, window or other opening. (Note - Not to be confused with facing)
Arris:	A sharp external angle.
Back Lining:	A thin member closing a jam or head of a cased frame.
Baluster:	A vertical individual member of a balustrade.
Balustrade:	The infilling between a handrail and a string, landing or floor.
Battened and Ledged Shutter:	The assembly of this type of shutter is composed of vertically V-Jointed, tongued and grooved battens tied together by a cross.
Battened, Lodged and Braced Shutter:	Same as battened and ledged, but braced against sag.
Bead:	A rounded moulding which may have one or two quirks.
Bead Ban:	A panel, flush with the framing, finished with a bead on two opposite edges only.
Bead Flush:	A panel, flush with the framing, finished with a bead on all edges.
Bed Mould:	A moulding under a window beard or shelf.
Blockings:	Pieces of timber fixed as stiffeners in the angles of casings, as in the heads of sash windows, stairs, etc.

Bolection:	A moulding raised above a surface.
Borrowed Light:	A window in an internal wall or partition.
Bottom Rail:	The horizontal bottom member of a door, casement or lower sash.
Brackets:	Short pieces of board fixed to the carriage of a stair to give additional support to the treads.
Carriage:	An inclined timber placed against the underside of steps to add support between the strings.
Cased Frame:	The hollow built-up frame of a sash window housing the counter balancing weights.
Casement:	The hinged light of a casement window.
Casement Door:	A hinged door, or a pair of doors, almost wholly glazed. (French door, French windows, glazed door).
Casement Window:	A window in which one or more lights are hinged to open.
Chamfer:	The surface produced by beveling an edge or corner.
Clear Span:	The distance between the wall on which roof is to be constructed.
Combed Joint:	An angle fanned by a series of tenons engaging in corresponding slot. (Corner locked, finger-joined, laminated).
Core:	The solid or skeleton structure of a flush door.
Cover strip:	A plain or moulded strip employed to conceal the joints of wall boards and the like.
Door:	A hinged barrier to close entrance to a room; consisting of a frame and one or more shutters.
Dead Light:	A light in which the glass is fixed direct into the framing.
Door Frame:	The surround, usually rebated, to a doorway in which the door is hung.
Door Lining:	The plain or rebated surround to an internal doorway in which the door is hung, usually the full depth of the opening.
Dowel:	A cylindrical piece of wood or metal used for fixing one piece of material to another. Wood dowels are sometimes grooved (keyed) to facilitate gluing.
Effective Span:	The horizontal distance between the centers of the bearings in roofs.

Fanlight:	A glazed light in the upper part of a door window frame.
Fillet:	a. A narrow strips or wood; and b. A small moulding of a square section.
Fixed Light:	A non-opening sash or casement.
Filler:	A tread with parallel edges in the straight portion of a stair, as opposed to a winder.
Flight:	A series of steps without changes of direction.
Flush:	A flush shutter is one in which the shutter has a framed core covered on both sides with plywood or hardboard with or without edge cover strips (lipping). The shutter may be solid cored or skeleton framed (hollow cored).
Flush Bead:	A bead run on a flat surface and level with it. (Note: Not to be confused with Bead Flush).
Flush Door:	A door with a surface in one plane on each face.
Folding Casements:	A pair of casements, usually with rebated meeting stiles, hung in a frame having no mullion.
Folding Doors:	A pair of doors, usually with rebated meeting stiles, hung in a frame having no mullion.
Frame:	A frame fixed to the soffits of an opening on which the shutter hangs.
Glazing Bar:	A rebated member dividing light into panes (Sash bar, astragal).
Glazing Bend:	A small wood strip of moulding employed as an alternative to putty to retain glass in a rebate.
Glue Blocks:	See Blocking.
Groove:	A continuous narrow sinking.
Ground:	The sawn or wrought member on which another finishing, e.g. a skirting is fixed.
Half Round:	A semi-circular moulding.
Half Space Landing:	A platform on width equal to two flights.
Handrail:	A rail parallel with a string or landing.
Head:	The horizontal top member of a window frame, door frame, or lining.
Head Weather Moulding:	A small additional member applied to the head of a window frame to protect the cement below.

Horn:	The projecting end of one of the members of a right-angled framing joint.
Inside Lining:	The inner member of a cased frame.
Jamb:	A vertical outer member of window of a window frame, door frame or lining.
Landing:	A platform at the termination of a flight.
Leaf:	One of a pair of doors or easement.
Light:	A single glazed unit of a window, fixed or opening.
Lip:	A solid wood strip applied to the edge or edges of a flash door.
Lock Block:	A piece of strip material in flush door providing for installation of lock, latch set, a drop, etc.
Mitre:	An angle joints between two members in which each is cut to a corresponding angle at their intersection.
Mortise or mortice:	A hole or slot to receive a tenon or dowel of corresponding size.
Mullion:	a. A vertical member dividing the light of a window frame. b. A vertical member between the door and sidelight of a door frame.
Muntin:	The vertical member between the panels of a door.
Newel:	The post supporting the edges of a string and handrail.
Nosing:	The projecting edge of a tread or board usually rounded.
Outside Lining:	The outer member of a caused frame.
Ovule:	A convex moulding, usually with quirk.
Panel:	The infilling to framing.
Paneled Door:	A door composed of a framed surround, divided into rectangular or other shaped spaces filled with panels usually of thinner material.
Paneled Shutter:	A paneled shutter is one in which the shutter frame is grooved or rebated to receive wood panels in openings between framing members. The frame may be constructed with mortice and tenon joints.
Parting Bead:	A narrow strip or moulding fixed to the pulley stiles of cased frames to separate one sash from another.
Parting Slip:	A narrow strip suspended inside an eased frame to keep the weight apart.

Picture Rail:	A trim fixed to the walls of a room, from which picture etc. may be hung.
Pitch:	It is the ratio of the rise of the truss to its span.
Planted Stop:	A moulding or strip applied to plain frame or lining against which a door or casement is stopped.
Plug:	Pieces of sound wood, suitably shaped, used to plug the wood from which defective portion has been removed.
Principal:	The wooden roof truss when used in buildings is sometime termed as principals. Principals are spaced 6 feet to 12 feet depending upon their type, distance between the wall and their pitch.
Pully Head:	A horizontal member at the head of a eased frame corresponding to a pulley stile.
Quadrant:	A convex (quarter-round) moulding.
Quarter Space/ Landing:	A platform of width equal to one flight.
Quirk:	A narrow groove or sinking at the side of a head.
Rafter:	The timber that support the roofing materials.
Rail:	A horizontal member of a casement or sash, such as top or bottom rail, or of a door, including top middle, lock, intermediate and bottom rails.
Meeting Rail:	A horizontal member at the top of a lower or the bottom or an upper sash.
Rebate:	A step shaped reduction formed on the edge of a member.
Reveal	The vertical side ore recess.
Reveal Lining:	The finishing of a reveal.
Ridge:	The highest point or line of a roof where the two opposite slopes meet.
Ridge Board:	Horizontal piece of timber forming the ridge.
Riser:	The vertical part of a step.
Sash Window:	A window in which the opening lights slide up and down in a frame.
Scotia:	A concave moulding (Cavetto).
Scribe:	To shape the abutting end of a member to the profile of another.
Sidelight:	A glazed light at the side of a door frame.

Sill:	The horizontal bottom member of a window or door frame.
Sill Bead:	A deep bead fixed to the sill of a sash window to permit ventilation at the meeting rails (Draught Bead).
Sill Drip Moulding:	A small additional member fixed to the sill of a window frame as an alternate to a sub-sill.
Sinking:	A recess on a surface.
Skirting:	The trim fixed to the walls of a room at the floor level.
Soffit:	A horizontal or sloping underside of any recess or stair.
Soffit Lining:	The finishing of any soffit.
Solid Frame:	A frame rebated out of the solid.
Solid Stop:	A rebate in a frame or lining against which a door or casement is stopped.
Spandrel or Spandril:	A triangular space formed by contiguous members.
Splay:	A chamfer fully extended across a surface.
Stairs:	A series of steps, with or without landings, including necessary hand-rails and balustrades and giving access from floor to floor.
Step:	A portion of a stair consisting of a tread and a riser.
Stile:	A vertical outer member of a paneled door, casement and sash.
Hanging Stile:	The stile of a door or casement to which hinges are fixed.
Meeting Stile:	The abutting stiles of folding doors or casement.
String:	An inclined board supporting the ends of steps.
Close String:	An outer string having its top and bottom edges parallel.
Out String:	An outer string with its upper edge out to the profile of the treads and risers (Open string).
Outer Siring:	The string on the side of a stair away from a wall.
Wall String:	The string on the side of a stair next to a wall.
Shutter:	The moveable screen mounted on the frame with hinge.
Sub-light:	The lowest light of a window, usually below casement.
Sub-sill:	A subsidiary sill member fitted to a window frame after manufacture.
Tenon:	The end of a member shaped to fit a mortise.

Tenon and Mortise Joint:	A joint in which a rectangular projection, machined on one piece, fits into a similarly shaped recessed opening, machined in a second piece, secured under pressure with an adhesive. In a through mortise joints, the mortise and tenon extend through the full width of the stile. In the blind mortise joints, the mortise and tenon do not extend through the full width of a stile.
Abutting Tenons:	Two tenons entering from opposite sides and abutting at the centre of a single mortise.
Haunched Tenon:	A tenon in which a portion of its width is reduced to form a tongue.
Lapped Tenon:	Two tenons entering from opposite sides and lapping in a single mortise.
Sub-Tenon:	A short tenon not extending through the thickness of mortised piece.
Through Tenon:	A tenon extending through the thickness of a mortised piece.
Threshold:	The horizontal sill-piece fixed to the floor in a door opening.
Throat:	A groove formed to prevent capillary attraction.
Tongue:	A reduction formed by rebate on one both faces at an edge or end of a timber to fit into correspondingly shaped groove.
Cross Ton:	A strip of timber with the grain not running in the direction of its length, or a strip of plywood, fitted into corresponding grooves in abutting members (loose tongue).
Transom:	a. A horizontal member dividing the lights of a window frame. b. The horizontal member, between the door and fanlight, of a door frame.
Tread:	The horizontal part of a step.
Trench:	A groove or channel extended across a member.
Trim:	A collective term for products of uniform profile manufactured by liner machining only, such as architrave, skirting, and picture rails.
Vent light:	A small opening in the upper light of a casement window, usually hinged at the top. (Ven sash, night vent, ventilator).
Weathered:	The term denoting the sloping upper surface of a member.
Weather Moulding:	A wood moulding fixed to the bottom rail of an external door to divert water from the sill or threshold (Weather board).
Wedge:	A tapered piece of wood.

Winder:	A tapering step in the turn of a stair.
Window Bead:	A small moulding planted round a cased frame to retain the inner sash.
Window Board: Window Frame:	A horizontal board fixed internally at the foot of window opening. The surrounding portion of a window containing sashes, casements or deadlights and in which the casements are hug or the sashes slide.
Wing-light:	See sidelight.
Wrot (Wrought Timber):	A piece or timber planed on one or more surfaces.

Doors

Wooden Doors and Windows: In modern buildings, wooden doors and windows are extensively used.

Doors consist of a frame and either one or two shutters hung to the frame by means of hinges. Doors with two leaves are known as hung folding or double-leafed doors and those with one leaf are known as single-leafed doors. Generally single-leafed doors are used in partitions and double-leafed doors in walls.

Sizes of Doors: Sizes of doors vary to suit the requirements, and no general rules specifying them can be laid down.

The overall dimensions of doors are usually determined by making the width equal to the height minus 4 feet. In ordinary buildings, the minimum height of a door is 6 feet without fanlight, and 7 feet 6 inches with fanlight. The maximum is usually not more than 7 feet 6 inches without fanlight and 9 feet with fanlight. The frame of a door is made of timber scantling usually 3 inches by 4 inches for doors of normal sizes; it is suitably increased for bigger sizes.

The modern trend is to omit the wooden sill of a door frame, since it causes obstruction to movement of the people and the floors cannot be easily washed and cleaned. Sill is, however, a must where air-conditioning is to be done. The sill portion of the door, equal in width to the timber of the door frame, should be raised by $\frac{3}{4}$ inch to 1 inch and the jamb and reveal portion of the sill sloped down on either side from it to meet the floor level. The bottom of the door shutter will thus remain $\frac{3}{4}$ -inch to 1 inch above the floor level and will not interfere with a carpet and at the same time facilities cleaning and washing. A half an inch rebate equal in width to thickness of the shutter is provided on the side of the frame to receive the shutter.

Location of Doors: The location of doors should make for the maximum use of accommodation in the room and privacy, without sacrificing convenience. As a rule, particularly in residential quarters, doors should not be located in the centre of room, but on one side of the room.

Types of Doors: The doors are generally of following types:

- Framed and paneled doors (glazed, partially glazed and unglazed).
- Ledged doors.
- Ledged and braced doors.
- Sash doors.
- Wire gauze doors.

Framed and Paneled Doors:

The paneled doors consist of stiles, rails, muntin and panels as indicated in a typical design. The door has framing which is grooved to receive panels of timber material. The number of panels may differ with the size of door and the taste of the people.

A few standard designs of interior as well as exterior doors in common use. Selection of any particular design is a matter of personal choice to match the general appearance of the building. The usual size of this class of doors is 7 feet by 4 feet, 7 feet by 3 feet, 6 feet by 4 feet and so on. The thickness varies from $1\frac{1}{2}$ inches to $2\frac{1}{2}$ inches depending upon the strength required.

Lodged Doors:

Lodged doors are the simplest form of doors. They consist of a number of vertical battens, planks fixed by nails, driven in from the face of the battens and fixed to the horizontal rails. The battens or planks are generally 1-inch thick and 6-inches wide and tongued and grooved with 'V' joint. The ledges are generally $1\frac{1}{2}$ inches thick and fixed over the battens which are cramped together to form the desired width of the door.

Ledged and Braced Doors: The ledged and braced doors are fundamentally similar to the ledged doors described above but have additional cross braces to make these stiff. Braces are nearly of the same size as ledges and make them strong enough not to drop down. Care should, however, be exercised to see that the battens of the brace lie on the hinged side, i.e. supported side; otherwise they would be of little use. The usual method of putting braces is to fix the door with ledges, and then fit them along with the nails to the battens.

Sash Doors:

In these types of doors, the lower portion is paneled while the upper portion is arranged for glass panels for providing greater light. The stiles are of smaller thickness and are sometimes called dimensioned stiles.

Flush Doors:

These doors have flush outside surfaces and are very popular as interior doors in all types of buildings. In some cases, the flush door may have a glazed panel at the top to let more light in the room.

Wire Gauze Doors:

These doors are commonly used for refreshment rooms, kitchens, larder cupboards, meat safes etc., to keep out flies. The shutters which are hung to the frame by hinge consist of stiles and rails which are rebated on the inside to receive the wire gauze. The gauze is fixed in position by a head braced to the frame of the shutter. Where wire gauze shutters are used in combination with some other type of shutters, the latter are

intended for security. These shutters are usually provided with an automatic closing arrangement in the form of a spring.

Windows

The construction of windows is very similar to that of doors. Their size and shape depend upon the size or the apartment.

Windows may be fitted with any one of the previously described type of shutters. Windows on the ground are usually iron barred. The bars are of about $\frac{1}{2}$ inch to $\frac{5}{8}$ inch diameter spaced at about 4 inches centre to centre.

Sills of windows may be at floors level or at any height above it. However, its height above floor ranges from 2 feet 6 inches to 3 feet 6 inches, if the window is of normal size. The bathroom windows have a height of 4 feet 6 inches to 5 feet for the sake of privacy. For protection against the sun and rain, windows have acquired different names according to their shapes or position in the building.

Location of windows:

The position of windows depends on the orientation of the building. An attempt is made to get the most of the effective light from the windows in the north wall because those in are the south wall a subsidiary and are mainly for ventilation. The restorative and recuperative value of light is almost equal to that of fresh air and this should specially be borne in mind in the case of factories, workshops and schools. Full advantage must be taken of the sunshine which is of real value in ventilation because it sets up convection currents in the air. It is also a powerful disinfectant.

The sills of windows are kept 2 feet 6 inches to 3 feet 6 inches above the floor and the window extends nearly to the ceiling.

The area of windows and ventilator is preferably between $\frac{1}{10}$ and $\frac{1}{5}$ of the floor area of the room. The latter value is adopted for chawls, dormitories, factories, schools and hospitals. The former value is adopted for residential buildings, in which the floor space per capita is more.

Types of Windows:

Windows are generally of the following types.

- Fast sheet window
- Pantry window
- Sash and Frame 'window
- Casement window
- French window
- Skylight window

Fast Sheet Window:

Fast sheet or fixed sash window consist or two stiles, top and bottom, with intermediate bars, if the size of the glass sheet is small, or if a special type of ornamentation is required. The stiles head and stile are usually 3 inches by 2 inches.

The joint is generally tenon and mortise; the stile A is mortised to receive tenons on the top and bottom rails.

Pantry Window:

The pantry window is a modification of the fast sheet window in as much, as a pivoted sash is added to give ventilation. The joint on the stile is the same as described for the fast sheet windows. The moulding is removed above the transom to receive the pivoted sash, which is rebated on the top and bottom rails only.

Sash and Frame Window: The sash and frame window have two sashes sliding vertically in a cased frame. The sashes are hung by means of cords, and are balanced by weights. These cords support the sashes and pass over pulleys. The frame consists of 6 inches by 3 inches sill, 5¼-inches by 1-inch pulley stile.

Casement Window: The sashes of casement window are hung. The casement window consists of a frame having two stiles, head, sill transom and mullion all of 5 inches by 3 inches timber. The casement is similar to the ordinary sash, all members are of 2 inches by 2 inches timber, except the bottom rail which are 2½ inches or 3 inches wide, casements open outside; hence the top lights are hung on the top.
When the casements open inwards, it is difficult to make the window watertight. This is avoided by providing weep holes in the sill.

French Window: This form of window has a confined door and window in it and is extensively used in wooden houses. If the doors open outwards, there is no difficulty in making it watertight. If the doors open inward, drainage water is always a source of trouble, for this reason a projecting metal bar is put in as a rebate, through which the water is made to seep out.

Skylight Window: A skylight is an opening in the roof itself for the provision of light. This is done when there is no other window or door for the lighting arrangement. The light runs parallel to the roof surface and is lifted above the slates by a cube of 9 inches by 1½ inches. Three sides of the cubes are at right angles to the inclined roof, but generally the front is perpendicular. A gutter is formed at the back and on the side to drain off the rain water. The sash consists of two stiles and slopes, 5 inches by 2 inches, with one or more bars of the same thickness. The most of the area in the skylight is fitted with glass to provide for light.

Hold Fast: Hold fast consisting of an inch Patti quarter of an inch thick, 1¼-inch wide and 13¼-inches long folded on both ends are quite necessary for the stability of doors and windows. They are fixed to the frame by means of wooden screws and the remaining portion is embedded or mortared in the masonry to keep the door or window in position. Generally, four of them are required for doors having a sill and six for doors without a sill.

Wooden Stairs

Wooden stairs are lighter than those of any other material, and are very commonly used in dwelling houses. The main objection to their use is that if fire breaks out, they are liable to catch fire quickly and thus may prevent escape from the upper floors. Teakwood of at least 2 inches finished thickness in all parts is, however, sufficiently fire-resisting to enable the occupants to escape within reasonable time.

The steps of wooden staircase are supported at each end, and frequently, at intermediate points, by sloping wooden members called string or pitching pieces. Strings are of four kinds: cut strings, housed strings, rough strings, and wreathed strings.

Cut Strings:

In the case of cut strings their upper surface is notched to conform to the tread and riser of each step; their lower edge is parallel to the slope of the stair.

In all but the commonest work, the vertical portion of the notch is mitred. The end of the riser is also mitred and fits against it, thus concealing the end grain of the wood. This is only done to the outer string which, when treated like this, is called a cut and mitred string. Cut strings in newel stairs are mortised and tenoned into the newel posts at top and bottom. The thickness of an ordinary cut string is 1½ inches to 2½ inches.

Housed Strings:

Also known as closed strings, housed strings have both their upper and lower edges parallel to the slope of the stairs. Grooves or housings are cut in their inner sides to receive the ends of the treads and risers.

The housing is sloped and the lower side of the tread and the inner side of the riser to receive wedges. The grooves are tapered to receive wedges for fixing the treads and risers firmly. The head room on the top of steps is of hard wood. These hold the tread and riser firmly in position. Against walls, housed strings are mostly used. In this position they are called wall strings. Closed outer strings are often moulded and paneled to produce an architectural effect.

**Rough Strings
(or Carriage):**

When the stair is so wide that the steps require an intermediate support, this is given by what are called rough strings. Rough strings also serve the purpose of supporting the laths (strips of wood on which plaster is applied) where the Soffit of the stair is to be plastered.

Wreathed Strings:

Wreathed strings are required in the construction of wooden geometrical stairs. Steps at wooden stairs are formed of boards. The treads are usually 1½-inch thick and risers 1 inch thick. The tread is made to project slightly (about ½ to ¼ inch) beyond the face of the riser so as to increase the available width of the tread. This projection is known as nosing which is usually rounded off or otherwise finished with a moulding.

The methods of jointing together tread and risers are on the left-hand side of the lower most step, the riser is jointed to the tread on its top by a tongue. Other methods of joining risers to trends are given below, on the top of the riser fitting into it corresponding groove on the underside of the tread.

1. By an angle block in the corner between tread and riser.
2. By a 5⁄8 inch x 1⁄8 inch Scotia glued into a groove in the bottom of the nose of the treads.

The riser of the step above it is tongued both at top and bottom into treads, beside there are angle block and scotia. The riser of the top most step has its bottom housed into a groove on the top of the tread and is further strengthened by screws.

Winders:

Winders are formed by cantilevering out the risers of substantial thickness from the staircase wall, and these are used to support the treads. The outer end of the cantilevered riser is housed into the newel post. The front end of the tread rests directly on the riser, while the rear end is fitted in a groove cut into the riser of the upper step.

Alternatively, winders may be supported by means or bearers built into the wall at one end and framed into the newel at the other. The back of the bearer is flush with that of the riser immediately over it. Cross bearers to support the treads are framed between the risers and the bearers behind them.

In a geometrical stair, the winders and bearers are framed into the wreathed string, and have cross bearers in the same way as for newel stairs.

Landing:

In forming half-space landings, a trimmer is fixed across the width of the staircase. It supports the bridging joints which are tenoned into the trimmer at one end and are supported on the wall at the other. The trimmer also takes the ends of the carriages or string of the up-and-down flights, and the newel is notched over it.

In forming a quarter-space landing, the pitching piece is built at one end into the wall. At the other end it is housed into the newel which may either be hanging or supported on the floor. In the former case, the pitching piece is required to be designed as a cantilever, and may have to be strengthened by means of a bracket on the underside. The pitching piece supports the bridging joints for the landing.

In a variety of wooden stairs lime concrete is poured into the stair box erected in position, consisting of two cut strings on either side, boarding supported, by a rough carriage at bottom, and risers fixed in their respective positions. When the concrete has set, the top is levelled, and boards are screwed to form treads.

Wooden Roof

In modern buildings wooden roofs are built to lend a decorative architectural touch or in less important buildings like country houses, domestic dwellings and temporary structures. But in hilly areas where timber is locally available, the wooden roof is cheaper as well as beneficial for quick disposal of rain water and snow. It is thus generally used.

Types of Wooden Roofs: There are two types of wooden roofs in common use:

- Simple roof
- Trussed or triple roof

Simple roofs consist of common rafters over a wall plate on either end, with or without purlins. These are generally boarded at the top. The double roofs consist of double system of timbering such as roofs with rafters and purlins, supported on walls. The trussed or triple roofs consist of common rafters, purlins, and trusses such as arched rib truss, queen post truss, etc. the composite roofs are built of wood and steel combined; the members taking tension are made in steel while the others are of wood. Some of the important types of roofs are discussed below.

Simple Roof:

Among the simple types of roofs; some of the important ones are lean-to roofs, couple roof, couple close roof and the collar roof.

Lean-To Roof:

This is the simplest form of roof. It is generally used in buildings attached to the main buildings, sheds or verandahs. If the span

is bigger purlins must be used. The overhang of the rafters is sometimes chiseled out, and a soffit is attached to it which can serve as a drain. The roof is attached to the wall by means of an iron corbel at regular intervals or by wooden wall plates 3 inches by 4 inches carried all along the wall in which the rafters come and fit.

Couple Roof:

This roof derives its name from the number of rafters used and are built for smaller spans. The two rafters are fixed at their ends to the wall by resting them on wall plates. The arrangement of the roof is very simple. Since the two rafters have a tendency to spread out and thrust out of the wall, this type of roof is not used for span wider than 10 feet. The supporting walls should, therefore, be sufficiently strong.

The roof has a suitable covering and to keep the birds out and prevent the wind from coming in, the brickwork is carried up to the underside of the boards.

Couples Close Roof:

This roof is similar to the couple roof, except for a tie member, which is fixed at the base of the two rafters to prevent them from spreading out. The tie serves a double purpose. It reduces the wall size and act as ceiling joists. This type of roof can be used for span up to 16 feet. Sizes of members are given in the table below:

Clear Span (feet)	Rafter Size	Ridge board size	Ceiling Joists size
8	3½" x 1½"	7" x 1½"	4" x 2"
10	4" x 2½"	7" x 2"	5" x 2"
12	4" x 2½"	7" x 2"	6" x 2"
14	5" x 2½"	8" x 2"	8" x 2"

Table 1, Size Of members (Chapter 12)

Collar Tie Roof:

To economize in space and to increase height, rooms are sometimes partly formed in the roof. For such conditions, a collar tie roof is made. This is done by providing a collar joining the two rafters, fixed about half way up the slope of the rafters. It acts similar to the tie in couple close roofs, i.e. checks the spreading of rafters. Sizes of various members are given in the following table: -

Clear Span (feet)	Rafter Size	Ridge	Collar
8	4" x 2"	7" x 2"	3" x 2"
10	4" x 2"	7" x 2"	4" x 2"
12	4" x 2"	7" x 2"	4" x 2"
14	5" x 2"	7" x 2"	5" x 2"
16	5" x 2"	7" x 2"	5" x 2"
18	6" x 2"	7" x 2"	6" x 2"

Table 2, Size of Members (Chapter 12)

Trussed Roofs:

If spans exceed the limit prescribed for collar tie or other types mentioned above, it is desirable to have a trussed roof both in the interest of economy and strength. In this type stresses are

taken up by the members and only vertical load is transmitted to the wall. This keeps the wall section within economical limits. Trussed roofs, therefore, consist of members arranged in such a manner that the shape of the truss does not alter and no member takes up bending moment. These are arranged 10 - 12 feet centre to centre on the walls or else on a convenient distance which is determined by the distance of columns. The important types of truss which is generally used is the king post roof truss.

King Post Roof Truss:

This type of roof truss derives its name from its vertical member, called king post. It can be used for spans up to 25-30-feet. It would be seen that the principal rafter carries purlins which in turn carry the common rafter. The covering of a suitable material is arranged over the common rafter. One of the sides is projecting out i.e. has overhanging eaves on one side and on the other gutter has been provided on the side of the wall.

Queen Post Roof Truss:

Queen post roof truss may be used up to 45 feet span. This roof has been prepared for slate tiles while for other covering the pitch can be suitably changed. There are two vertical members called queen posts from which this truss derives its name. The members are joined at their ends by proper joints and steel stirrups. A straining sill is attached to spikes to the top of the tie beam to assist the queen post in resisting the thrust of the struts. A straining beam is used at the head of the queen posts to resist the thrust from the rafters.

12.1.2 Materials**12.1.2.1 Timber****1. Source**

Timber to be used for woodwork shall consist of deodar wood, shisham and kail wood as specified and shall be procured from an approved source. Brief description in their respect is as under;

Description	Uses
Shisham Weighs about 49 lbs., per cubic foot. It is a large tree of plain areas as well as the Sub-Himalayas forests growing at the altitude of about 3000 feet or less. Its sapwood is pale brownish white and heartwood is golden brown to dark brown with deeper brown streaks. The wood is dull with interlocked grain and medium coarse texture. It is easy to season but hard to work. It keeps its shape well if properly seasoned and takes on fine finish.	It is chiefly used for flooring paneling furniture, sports goods, turnery and wheel work; when peeled it can be made into beautifully grained plywood panels.
Deodar Weight about 35 lbs. per cubic foot. It is the most important soft wood of Pakistan found in the Himalyan ranges between 4000 to 7000 elevations. It is yellowish brown in colour. Its heartwood is strong and durable due to natural preservatives in it. It is easy to season and work and retains its shape well.	Being light and moderately strong, it is used for structure work, railway carriage wagons, planking, shingles, pattern making and cheap furniture etc.
Kail An evergreen tree, moderately hard, durable and close grained. It is found in the Himalayas. Weights about 32 lbs. per cubic foot.	It is used for furniture house building are railway sleepers, etc.
Fir, Paludar, Partal An evergreen tree having light and soft wood with an average weight of 30 lbs. per cubic foot (air dry) occurs naturally in North Western hilly areas from 2000 to 3000m elevation.	It is used for railway sleepers, planking for floors, ceiling, cheap type door and windows, house construction and paper pulp etc.
Chir, Chill An evergreen tree having durability when placed under cover but non-durable in exposed conditions. An average weight of 38 lbs. per cubic foot (air dry) occurs naturally in North Western hilly areas from 450 to 2400-meter elevation.	It is used in building construction, roofing and flooring, furniture making and also used for fuel wood.

Table 3, Timber (Chapter 12)

2. Quality**a. General**

- Timber shall be of good quality in accordance with the requirements of BS:1186, felled not less than two years before use for carpentry and four years for joinery and shall be properly seasoned.

- Timber shall be uniform in texture, straight in fiber, free from open shakes, bore holes, fungus attack rots, dots, decay, warp, twist spring or crook and all other defects and blemishes.

b. Sapwood

- Sapwood shall not be permissible in hard wood thresholds and projecting window sills.
- Sapwood shall not be permissible in hard wood joinery unless properly treated with a suitable preservative as approved by the Engineer-in-Charge.
- In soft wood joinery which is ordered as 'selected for staining' discolored sap wood shall not be permissible in surfaces which are intended to receive the final decoration.
- In all other uses sap wood including discolored sap wood if sound shall be permitted.

c. Knots

- Exposed surfaces of hard wood sills shall be free from knots other than isolated sound tight knots not exceeding $\frac{3}{4}$ inches in diameter.
- In joinery which is ordered as 'Selected for staining' all surfaces intended to receive final decoration shall be free from knots.
- Glazing bars shall be free from all knots other than sound knots appearing on one surface only and not exceeding $\frac{3}{4}$ " diameter in the web and $\frac{1}{2}$ " diameter elsewhere.
- Loose or decayed dead knots shall not be permissible in any joinery and shall be cut out and plugged properly.
- In all other cases sound and tight knots including knot clusters which appear on any surface shall be permitted subject, to a maximum of:
- One live knot measuring 1 $\frac{1}{2}$ " to 2" across the major diameter per 2 feet length, i.e. a Max of four 2" knots per 8 feet length and five such knots in 10 feet length. (Smaller live knots shall be tolerated provided they are not so numerous or on ground as to affect unduly the strength of the sawn out turn there-from).
- One dead knot measuring $\frac{1}{2}$ " to 1" across the major diameter per 3 feet length, i.e. three such knots per nine feet length and four such knots in twelve feet length (Dead knots below $\frac{1}{2}$ " diameter shall, however, be considered as negligible).

d. Shakes

- Straight splits or shakes shall be permissible up to a total for both ends of $\frac{1}{2}$ inch per foot of length at the time of passing.
- Timber shall not be spongy or in brittle condition.

e. Storage

Timber shall be stacked on a raised wooden or paved platform to eliminate chances of white ant attack. It shall be stacked under a proper shelter where maximum aeration is possible without subjecting it to the direct sun, rain or other weathering agents.

3. Logs End Squares

a. Source

Logs or Squares shall be obtained from an approved source.

b. Size

- Round logs shall not be of size less than 10 feet in length and 60 inches in girth.
- Logs shall not be longer than 35 feet in length. Tapered logs shall not be less than 54 inches in girth at the small end.
- Squares shall be of the size not less than 10 feet in length and 15"x15" in cross section.

c. Quality

Logs or squares shall conform to the specifications for Timber, 12.1.2.1.

4. Seasoning**a. General**

The object of seasoning timber is either to expel or to dry up the sap remaining in it, which otherwise putrefies and causes decay. The seasoned timber does not decay, or warp or bend due to temperature variations as in case of moist timber. The seasoned timber works easily under the saw and its shape and dimensions do not change with variations in temperature or with age. The seasoning also increases the strength of timber. The timber for carpentry is well seasoned when it has lost its weight by 1/5th. Timber for joinery is fit when it loses about 1/3rd of its weight after felling.

b. Method of Seasoning

Wood can be seasoned in drying kilns or by air seasoning. Kiln seasoning though very helpful in our country, where the high humidity during certain part of the year, precludes effective air seasoning.

c. Air Seasoning

For air seasoning there are two important points to be attended to. First is the proper piling and stacking of timber and the second is the protection of wood from rain, sun and hot wind. The wood pile should be on proper foundation of wood, masonry or concrete. Concrete or brickwork foundations are the best. One square foot pillars at 4 to 5 feet intervals and rising 1 foot above the level of the ground will do. The distance between the two rows of pillars forming the two sides of the stack should also be 4 to 5 feet. For protection against termites, termite guards are provided near the top of the pillars, with a bend down edges protruding all round.

The orientation of the stack foundation is also a matter of considerable importance. Generally, the length of the pile should be in the same direction as the prevailing dry wind. The main force of the hot dry wind is then met by the sides of the crossers and only one end of the planks is exposed to heat. Piling of timber is to be done in a systematic manner. Lack of care in proper piling results in wastage of timber through crack warp, rot, stain and termite attack. All these can be avoided with a little extra expense or trouble. Other important factor is protection of the stack from hot wind, sun and rain. The direct rays of the scorching sun can cause very rapid drying of wood on the exposed surfaces and consequent splitting and cracking. Timber can be classified into six categories based on the seasoning behavior. They are; -

- Very easy to season but require quick seasoning,

- Easy to season,
- Season well with care,
- Crack in seasoning and so difficult to season,
- Season well but take a long time to season and
- Crack badly in seasoning. In 12.1.2.1(1) giving individual description of wood of the seasoning behavior has been stated based on the above classification.

Timbers which crack in seasoning and so are difficult to season or crack badly in seasoning, should be dried so as to prevent rapid drying. Timbers which season well with care, or season well but take a long time to season, should be seasoned in shades open on the north with a sufficient overhang so that the pile is protected from the rain. In case of timbers which are easy to season or very easy to season but require quick seasoning, it is necessary, that the timber should be piled under a good weather-proof roof but the sides should be always exposed to air and the sun. In the cases of timbers which require quick seasoning it is a good practice to stand the planks up on the ends against a horizontal support for a week or two after conversion to prevent formation of mould and staining. After a short period of vertical stacking the plans should be piled horizontally as described.

12.1.2.2 Plywood and Veneer

1. Plywood

Plywood shall be an assembled product made up of plies and adhesives, the chief characteristic being the crossed plies which distribute the longitudinal wood strength. The term plywood in general sense shall include similar products such as laminated board, block board and batten board. Plywood shall conform to BS1455 whereas laminated, block and batten boards to BS 3444.

Three ply constructions shall include a "face" a "back" and a core or inner ply. Multi-ply shall include a face, a back and a core of three or more inner plies. With very few exceptions the grain of each veneer in the core shall run at right angles to that of the veneers on either side of it. The construction of plywood may be balanced with an odd number of veneers arranged symmetrically or unbalanced. The tendency of the finished board to distort shall be reduced by adopting a balanced construction. Plywood according to BS1455 shall be classified into two main types, viz interior and resin bonded. Interior type plywood shall be suitable for most interior work including wall paneling, subflooring, kitchen filaments, and any location where resistance to moisture is not required. Adhesive used shall include casein, soya, blood albumen and animal glues as well as synthetic resin extended with other substances.

Synthetic resin bonded plywood shall have a much greater resistance to moisture. The more resistant types shall be suitable for external wall sheathing, shop front fascias, sign boards, shuttering and form work for concrete and for any purpose where it may be exposed to moisture. Adhesives used shall include urea, melamine phenol and resorcinol formaldehyde (arranged in order of increasing moisture resistance).

2. Veneers

Grade I Veneer shall be of one piece of firm smoothly cut veneer. The veneers shall be free from knots, worm and beetle holes, splits, dots, glue-stains, filling or In laying of any kind or other defects. No end joints shall be permissible. Grade II Veneer shall present a solid surface free from open defects. Veneer may be in one or two pieces.

Veneers when jointed need not necessarily be matched for color or be of equal width. A few sound knots shall be permitted with occasional minor discoloration and slight glue stains, isolated pin holes not along the plane of the veneer. Grade I veneered plywood shall only be used if not specified otherwise. Grade II shall be used if specified and where subsequent painting and/or veneering is intended.

3. Laminated Veneered Board

It shall be built-up board, with narrow strip 3 to 7 mm wide, faced both sides with either one or two veneers from 1.2 mm to 3.7 mm thick. Where single or double face veneers are used, the grain shall usually run at right angles to the grain of the core strip. This type of board, conforming to B.S. 3444 and of a thickness between 13 mm to 25 mm, shall be the base for the highest class of veneered wood.

4. Block Veneered Board

Block board conforming to B.S. 3444 shall be of similar construction as of laminated board but the core shall be built-up of blocks up-to 25 mm wide. It shall be used as a base for veneering and for painted work.

5. Fiber Building & Chip Board

The term "board" in general sense shall include fiber building boards and the chip boards(or particle boards). The fiber building boards shall include hard boards, insulation boards and straw boards.

6. Fiber-Building Boards

a. Hard Board

Mass per unit volume of hard boards shall range from 480 to 800 Kg per cubic meter and shall be classified according to this density (mass per unit volume). Tempered hard board/standard hard board shall be treated to increase hardness and resistance to water.

b. Insulation Board

Insulation board shall have maximum density of 400 Kg/Cu meter, minimum thickness of 11 mm and maximum thermal conductivity (K) of 0.45. Insulation boards classified as homogeneous laminated, bitumen bonded, bitumen impregnated and acoustic shall have good qualities of thermal insulation and sound absorption. Acoustic boards shall be of low density and specially designed (Often with perforated surface) to increase sound absorption.

c. Straw Board

Straw boards shall be made of straw compressed and formed into slabs 50 mm thick by heat and pressure and with proprietary paper glued to the sides. Edges too shall be bound with paper. The slabs shall be fairly stiff and shall have thermal conductivity (k) of 0.6.

7. Chip Board (Particle Board)

Chip boards shall be made of wood particles in the form of chips or shavings of a controlled

size combined with a thermo setting synthetic resin glue binder and formed into panels under the influence of mechanical pressure and heat. The process of adhesion shall be controlled resulting in a variety of boards with different but predictable physical properties. Chip Board, if specified, shall be used in sheathing, flooring and sub-flooring, wall paneling, partitions, shelves, furniture and veneered boards. It should not be affected dimensionally by changes in atmospheric humidity, though in wet conditions it shall have a limited resistance to moisture. The surface finish of standard boards shall be comparatively rough and to support a good quality paint or varnish finish it shall require sanding and filling. Special grade of the board which have a paper surface permanently bonded to the board during manufacture shall be used for painting. Chip boards shall be classified in grades of high, medium and low density mainly in thickness of 13 mm and 19 mm. The density range of this board is from 480 to 800 Kg per cubic meter as under: -

- High Density (HDF): Above 800 kg/m³
- Light (LDF): Below 650 kg/m³
- Ultra-Light (ULDF): Below 550 kg/m³

Due to variation between brands, the weight of chipboard is not constantly proportional to thickness. Typical weights, based on standard chipboard with average density 750 kg/m³, are:

Thickness	Mass Per Unit Area
13.0mm	9 kg/m ²
16.0mm	11.0 kg/m ²
19.0mm	14.0 kg/m ²

Table 4, Chipboard (Chapter 12)

Chipboard is available in an extensive range of thicknesses, i.e. 1.8mm to 60mm. The most common sheet sizes are: widths 1220mm, 1525mm and 1850mm and in lengths up to 3660mm.

12.1.2.3 Adhesives

For joinery work, animal glues complying with B.S:745 or synthetic resin adhesive complying with B.S:1204 shall be used. For flush doors and other forms of construction that rely mainly upon the adhesive, and particularly where exposure conditions are severe and prolonged dampness is likely to occur, one of the more moisture resistant adhesive shall be employed, the choice depending upon the severity of the conditions to which the work will be exposed.

12.1.2.4 Hardware

1. Nails and Screws

For joining work, wire nails oval, chequered head, lost head round or panel-pins complying with BS:1202, or wood screws in accordance with BS: 1210 shall be used. The gauge of nail or screw used shall be suited to the woods being fixed and to which a fixing is being made, and the length shall be such as will give a sufficiently strong and secure fixing. CP:112 shall be followed which gives relationship between gauge amount of penetration and strength. All nails and screws used with reactive timber (becoming stained and disfigured by reaction with ferrous metals) shall be of non-ferrous metals or shall be given protective coating before use if the woodwork is likely to be subjected to moist conditions, e.g. external doors.

2. Finish Hardware

Hinges, tower bolts, handles, locks catchers, stoppers, railings, supports, appurtenances, fixings, fittings and all other items metallic, plastic or wooden considered as finish hardware shall be as shown on the Drawings or required in the Specifications and approved by the Engineer-in-Change for the specific job.

12.1.3 Construction Requirements

12.1.3.1 Quality and Finish

Unless otherwise specified timber shall conform to the Specifications for timber given in Chapter-8 of Book-1 of these Specifications. The Engineer-in-charge shall at his option inspect all logs or sleepers before they are used and may reject any, he considers defective. Timber so rejected shall be removed at once from the site of work at the cost of contractor. All wood work shall be neatly and truly finished to the exact dimensions specified.

12.1.3.2 Joints

Unless otherwise specified, all joints shall be simple tenon and mortise joints with the end of the tenon exposed to view. All mortise and legion joints or scarves shall fit truly and fully, without filling. Where specified, in the cape of special high-class joinery, the end of the tenon shall not show. Joints shall lie painted with specified lead paint before the frames are put together. Glue shall not be used in joints which are exposed to weather, and in such exposed work any hard stopping shall be done with tight driven plugs.

12.1.3.3 Screws and Nails

All nails and screws shall be of an approved type. Holes of concrete size shall be drilled before inserting screws. Hammer shall not be used at all for driving in or starting in the screws. All screws shall be dipped in oil before they are inserted in the wood. The heads of nails or screws shall be sunk and puttied or dealt with as directed by the Engineer-in-charge.

12.1.3.4 Wood to be covered in ground or in wall

The contractor shall give at least 7 days' notice to Engineer-in-charge in writing, when any timber is to be covered in the ground, or in the walls of a building, or otherwise. Failing this the Engineer-in-charge may order it to be uncovered at the contractor's expense, or measure and pay for only so much as is uncovered.

12.1.3.5 Fixing

All wood work shall be fixed in accordance with the drawings or the instructions of the Engineer-in-charge.

12.1.3.6 Workmanship

All Workmanship shall be of the best type and all joints shall fit accurately without wedging or filling. After the wood work has been erected, the contractor shall, if any undue shrinkage or bad workmanship is discovered, forthwith correct the defect without any extra charge.

12.1.3.7 Bearing

All beams and girders shall be bedded on plates with not less than 9 inches bearing. All joists shall bear not less than 4½-inches on wall plates, and every purlin or batten supported on a wall shall have a bearing in the direction of its length equal to its own depth subject to a minimum of 4 inches.

12.1.3.8 Air Space

An air space or quarter of an inch shall be left along sides of battens and other wood work buried in masonry or brickwork.

12.1.3.9 Preservatives

All portions of timber built into or against or close to masonry or concrete, and all junctions or rafters, purlins, beam and wall plates shall be given two coats of hot solignum, creosote or other wood preservative approved by the Engineer-in-charge.

12.1.3.10 Planks

All scantling planks etc. shall be sawn straight and shall have uniform thickness. They shall be sawn in the direction of the grain and shall have full measurement from end to end. All planks and scantlings shall be sawn 1/16 inch in excess of actual measurement to allow planning. They shall be supplied with straight square edge, or rebated, ploughed, tongued or dwelled, as may be directed.

12.1.3.11 Chimney Flue

As a precaution against fire no wood work shall be fixed within 2 feet of the interior face of a chimney flue.

12.1.3.12 Deodar Wood

Unless otherwise specified the wood used in construction or joinery work shall be deodar, kail, chir or teak.

12.1.3.13 Responsibility of Contractor after Fixing

The contractor shall be responsible for the easing or otherwise of all doors etc. and the closing, down of all open joints which may occur within 6-months of the completion of the work and which in the opinion of the Engineer-In-charge required attention.

12.1.4 Measurements

The measurement of wood work or planking shall be the net measurement after fixing in position. No allowance is to be made for waste overlaps, rebates or the dimensions supplied beyond those specified. The length of each piece, however, shall be taken over all so as to include projection for tenon or scarfs. The unit of measurement shall be 100 square feet or 100 cubic feet as specified.

12.1.5 Rates and Payments

12.1.5.1 Labour Rate

The unit rate for wood work shall include the cost of labour involved to carry out wood work according to above specifications, fixed in position and with the exposed arises finished with

a bead or bead and quirk as specified. The rate shall further include the cost of labour employed for following operations: -

- i. Fixing all spikes, nails, screws, glue.
- ii. Beveled heading joints to boarding.
- iii. Boring for bolts as required.
- iv. Cleaning of wrought face.
- v. Cramping and wedging.
- vi. Fixing with hardwood or male bamboo pins, nails, spikes, hoop iron and wire in any position.
- vii. Halving, tabling, lapping, notching, framing, straight, splay, circular or birds-mouth cutting, splayed and beveled ends, and miters, fair or returned ends, as required.
- viii. Punching and clenching nails.
- ix. Treating plugs with wood preservative.
- x. All notching's, firings, or squaring's to bellies, necessary to obtain level bedding, boarding or fixing.
- xi. Rebates and chambers to door and window frames where required.

The rebates shall further include the use of all tools, plant and scaffolding, staging and ladders etc., where necessary.

NOTE: Sometimes timber in the form of log or wrought (wholly or partially) is supplied to the contractor from the Government stores or from a dismantled building. In such cases the cost of timber so supplied shall be deducted from the cost of the finished work. Where the contractor's schedule contains no rate for similar materials the cost to be deducted shall be determined by a special agreement. A separate rate shall be required when the material thus supplied has to be reframed or refitted.

12.1.5.2 Composite Rate

The unit rate shall include the cost of all materials supplied to the site of work in addition to the labour rate detailed above.

12.2 Doors and Windows

12.2.1 Construction Requirement

12.2.1.1 Quality

Unless otherwise specified timber shall conform to the approved Specification for timber.

12.2.1.2 Workmanship

Unless otherwise specified the workmanship for doors and windows shall conform to Specifications for Wood Work (General) in all respects, except those specified hereunder.

12.2.1.3 Size of Doors and Windows

The size of doors and windows shall be as specified.

12.2.1.4 Section and Fittings

Unless otherwise specified or directed, the particulars and dimensions of chowkats for doors and windows together with their fittings and furniture shall be as given.

12.2.1.5 Chowkats, Framing and Corners

Chowkats shall be properly framed and mortised together. Door and window chowkats shall have 4¼ inches wide horns left on the heads (also on sills where these are provided) or the corners of the chowkats bound with 2¼ inches by 1/10-inch iron straps bent into a right-angle having legs of a length equal to the depth of the chowkats, and fixed with 4, 2-inch screws. The cost of horns or straps is included in the rate. Unless otherwise specified, the latter method shall be adopted. Chowkats size should be followed as given in Annexure No. 1.

12.2.1.6 Rebates

Chowkats shall have a rebate cut to receive the leaves. The rebate shall be ½-inch deep and its width shall be equal to the thickness of the leaf. The other side shall be finished with a bead and quirk, or other simple molding, unless wire gauze is to be fitted. Where the plaster butts against the chowkats ½-inch deep rebate with a slight cut back shall be given to serve as key to the plaster.

12.2.1.7 Position of Chowkats in Jambs

Unless otherwise specified, doors and windows opening to another room, to a corridor or verandah, shall have the chowkats so fixed that they project ⅜ of an inch from the plastered face of the wall.

The plaster shall stop against the chowkats which shall have the rebate mentioned in the above paragraph as key for the plaster.

Other doors and windows shall be set back 4½-inches from the face of the wall.

In case of doors and windows in dhujji walls, the depth of the chowkats shall be equal to the thickness of the wall and the faces flush with the plaster.

12.2.1.8 Chowkats to be ready before starting Superstructure

No chowkats shall be painted or fixed before the Engineer-in-Charge has inspected and approved it, all chowkats shall be ready before the work reaches the sill level so that they can be built in as brickwork or masonry proceeds.

12.2.1.9 Chowkats painting with Preservative

Before fixing, chowkats shall have the side in contact with the brickwork or masonry painted with two coats of hot solignum, creosote, coal tar or other wood preservatives approved by the Engineer-in-charge. If doors and windows are to be subsequently painted, the priming coat shall be painted on the chowkats before they are fixed.

12.2.1.10 Hold Fasts

Chowkats shall be secured to the brickwork or masonry by holdfast which shall be built into the wall with specified mortar. Holdfasts shall be made 1½" x ¼" flat steel Patti bent over at both ends leaving 13¾" clear length between bends; one bend shall have two screwed holes to which the chowkat is secured by bolt ½-inch in diameter. The head of the bolt shall be sunk into the chowkats and the hole plugged with wood. Where the chowkats is fixed at the extreme edges of the jambs, the hold fasts shall be worked or bent as directed by the Engineer-in-charge. The number of holds fasts to each chowkats shall be as indicated, with the exception that, where no sill has been provided, one additional hold fast shall be given on each side. The feet of the chowkats shall, in this case, rest on the damp-proof course or floor, as the case may be.

12.2.1.11 Seasoning

All door and window leaves shall be cut out and framed together, as soon as possible after the commencement of the work, and stacked in the shade to season. They shall not be wedged and glued for four months where possible and where the contract time permits. If it is not possible, they shall be wedged and glued just prior to being hung. Before final gluing, all portions in which defects appear shall be replaced.

12.2.1.12 Method of Framing Leaves

All stiles and rails shall be properly and accurately mortised and tenoned. The thickness of the tenon shall not exceed ¼th the thickness of the plank and the width shall not exceed 5-times the thickness. All rails over 7 inches in depth shall have double tenons. All tenons shall pass completely rough stiles and shall be secured by ⅜-inch hard wood or bamboo pins. All rails shall be haunched to the depth of groove for panels.

12.2.1.13 Gluing

All tenons at the final assembly of the doors shall be glued and wedged at top and bottom of the tenon with glued wedges. Immediately after gluing, the frames shall be tightly clamped and so left till the glue has set.

12.2.1.14 Hinges

Unless otherwise specified, leaves shall be hung un hinges of the size and the number specified in specifications; These hinges are to be of an approved type and quality. They shall be counter sunk into the chowkats as well as in the leaf; the recesses being cut to the exact size and depth of the hinge; no subsequent packing shall be allowed. 2-inch screws shall be used with 5-inches to 6-inches hinges and 1½-inches for smaller sizes.

12.2.1.15 Fitting

The contractor shall deposit in the office of the Engineer-in-charge one sample of each fitting to be used in the work. Unless otherwise specified, fittings shall be of the number, size and type given.

12.2.1.16 Special Door Furniture

The cost of fittings as indicated in the table is included in the rate. Where special ironmongery or door furniture is required, it shall be supplied by the department, or provided by the contractor at an extra cost. The cost of fixing or mounting such special furniture shall, however, be included in the rate. The cost of fittings superseded by the special ones, and thus not actually supplied, shall be deducted from the sum paid for wood work.

12.2.1.17 Screws

Screws of such diameter shall be used as fill completely the holes and cups in the fittings which they secure, and shall be oiled before being inserted. Unless the head can be counter-sunk flush with the fittings, round headed screws shall be used. Brass fittings of specified type shall be secured with brass screws.

12.2.1.18 Chocks

Hinged chocks shall invariable be fitted to all doors and window to keep them open. Chocks shall be of hardwood and swung on 3-inches butt hinges and shall act on a sheet metal protector fixed to the door stile.

12.2.1.19 Stops

Wooden stops of a size suitable for the leaf concerned shall be fixed to the door or window chowkats to prevent the leaf from damaging the plaster of the jamb when fully opened.

12.2.1.20 Bars / Grills

MS bars/grills shall be fixed as per detailed drawing or as directed by the Engineer.

Fixing: For fixing MS bars in wooden frames of window etc. through holes shall be drilled in one side of the frame and in the other side of the frame, holes shall be drilled 5 cm deep. The bars shall be passed into the frame from one side and these shall be of correct length to fit in at one end and to flush with outside of the frame at the other end. Where there are MS flats provided along with the bars, these shall be fixed at the ends to the wooden frame with wooden screws. Holes for passing MS bars shall be punched in the flats at proper position. The grills shall be fabricated as per design and fixed to the frame by round headed bolts and nuts in new work, and by wooden screws in old work.

Measurement: The length of MS bars and flats shall be measured correct to 10 mm. and their weight calculated in lbs from standard tables.

Rate: The rate includes the cost of labor and materials required for all the operations described above.

12.2.1.21 Providing and fixing expanded metal mesh (1/2" – 3/4", 16 gauge)

Expanded metal shall be fixed to the Chowkats on the outside or inside as per detailed drawings or as directed by the Engineer. These shall be cut in one piece to the size of the

frame (out to out). Expanded metal shall be fixed on to the frame with staples, over which wooden beading 60 x 20 mm shall be fixed with wood screws.

Measurement: The length and breadth shall be measured correct to 10 mm, the area from outside to outside of beading shall be calculated in square feet nearest to two places of decimal.

Rate: It includes the cost of labor and materials required for all the operations described above.

12.2.2 Measurement

The measurement of doors and windows shall be done by the superficial area of the clear opening in brickwork or masonry. In case of circular or other similar joinery, measurement shall be taken of the net area. In the absence of any special rate being paid, measurement shall be taken of the least squares or rectangles to contain the opening in question. In case of double doors, the superficial area of chowkat shall be included in one door only.

12.2.3 Rates & Payments

12.2.3.1 Labor Rate

The unit rate shall include the cost of labor involved in making and erecting doors and windows of the specified sizes complete in all respects, with fitting and furniture according to above specifications in specified places.

- The rate shall also include the list of ladders, supports, staging, and scaffolding for executing wood work according to above specifications.
- The rate shall further include the cost of labor involved in applying two coats of wood preservatives on the chowkats.

12.2.3.2 Composite Rate

The unit rate shall include the cost of all materials supplied at site in addition to the labour rate detailed above.

12.3 Paneled and Glazed Doors and Windows

12.3.1 Construction Requirement

12.3.1.1 Design

Unless otherwise specified the paneled and glazed doors shall conform to the approved design.

12.3.1.2 Dimensions

Unless otherwise specified the dimension of doors and windows shall be according to the approved drawing.

12.3.1.3 Quality of Timber

Unless otherwise specified or directed by the Engineer-in-charge the wood shall conform to the Specification for timber.

12.3.1.4 Door Frame

- i. The members shall be joined with closed fitting mortise and tenon joints which shall be further pinned with corrosion-resisting metal pins of not less 8 mm (5/16-inch diameter or with hard wood pins whose diameter shall not be less than 10 mm ($\frac{3}{8}$ inch). The framing shall be such as to ensure complete rigidity throughout.
- ii. The entire surface of frame coming in contact with masonry shall be treated with a preservative of an approved type and quality.
- iii. The frame shall be fixed to the masonry with at least four hold fasts. Two additional hold fast shall be used if the chowkat is without a sill.

12.3.1.5 Shutter Frame

The stiles and rails of the frame shall be mortised and tenoned together. The thickness of each tenon shall be approximately $\frac{1}{3}$ rd. the thickness of the rail, and the width of each tenon shall not exceed 5 times its own thickness.

12.3.1.6 Panel

- i. Panels shall be made of solid wood or hard board or water-resistant plywood having both sides properly finished. They shall be truly cut and framed into rebates to a depth not less than $\frac{3}{8}$ -inch. Their thickness shall not be less than 12 mm ($\frac{1}{2}$ -inch); in case of plywood and hard board it shall not be less than 7.5 mm (5/16 inch). Panels shall be in one piece up to 12-inches clear in case of deodar and 18-inches clear in case of teak. In larger sizes they shall be jointed, but the joints shall be glued and dowelled together to prevent all possibilities of its opening out afterwards.
- ii. Panels shall be absolutely smooth so that no marks are visible. Unless otherwise specified, panels shall be splayed and fielded on both sides and the arises of the frame receiving the panels finished with a simple mould.

12.3.1.7 Sash Bars

Sash bars shall be of the same thickness on the leaf and shall be 1-inch to 1 $\frac{1}{4}$ -inch wide, according to the size of the doors, and shall be twice moulded and twice rebated and Mitred

on the outside. The size of the rebate shall be $\frac{3}{8}$ -inch x $\frac{1}{2}$ -inch to receive the glass and its fixing.

12.3.1.8 Glazing

All glazing shall be done in accordance with the Specification for glazing. If specified, the doors and windows of bedroom and bathroom shall be glazed with blind glass up to full eye level. The glass panels of appropriate sizes shall be fitted into ($\frac{3}{8}$ -inch) rebates and shall be retained in position with a thin layer of putty which shall be covered with wood beading.

12.3.2 Measurement

The measurement shall be done by the superficial area of the clear opening in brickwork or masonry. In case of circular or other similar joinery, measurement shall be taken of the net area. In the absence of any special rate being paid, measurement shall be taken of the least squares or rectangles to contain the opening in question. In case of double doors, the superficial area of chowkat shall be included in one door only.

12.3.3 Rates

12.3.3.1 Labor Rate

- a. The unit rate shall include the cost of labor involved in making and erecting doors and windows of the specified sizes complete in all respects, with fittings and furniture according to above specifications in specified places.
- b. The rate shall also include the use of ladders, support, staging and scaffolding for executing woodwork according to above specifications.
- c. The rate shall further include the cost of labor involved in applying two coats of wood preservatives on the chowkats.

12.3.3.2 Composite Rate

The unit rate shall include the cost of all materials supplied at site in addition to the labour rate as detailed in Heading 12.3.3.1.

12.4 Framed and Braced Doors and Windows

12.4.1 Construction Requirements

12.4.1.1 Frame of Leaf

Framed and braced doors shall consist of two stiles, three rails and two braces forming the frame of each leaf to which the battens (planks) shall be fixed. In case of windows there shall be two rails and one brace. In the case of doors opening outside, where it is necessary to admit light, the Engineer-in-charge may direct the addition of a frieze rail. In this case the space between the frieze rail and the top rail shall be glazed by the contractor without any extra charge.

12.4.1.2 Framing and Bracing

The framing shall be made with mortise and tenon joints as per Specifications. The top rail (or frieze rail when the door has been glazed) and the bottom rail as well as stiles shall be rebated to receive the battens. The exposed edges or stiles and rails shall be chamfered or stop chamfered.

12.4.1.3 Battens

Battens shall butt into rebates in the top (or frieze) rail and the bottom rail and shall pass over the braces and the lock rail. Battens shall not be more than 5-inches wide and shall all be parallel and uniform in width. The joints shall be ploughed and tongued and finished with a bead and quirk on the outside. Battens shall be secured with two screws at each end and with one screw over each brace and the lock-rail.

12.4.1.4 Other Respects

In all other respects, a framed and braced door/ window shall conform to specification for Doors and Windows (General).

12.4.2 Measurements

The measurement shall be done by the superficial area of the clear opening in brickwork or masonry. In case of circular or other similar joinery, measurement shall be taken of the net area. In the absence of any special rate being paid, measurement shall be taken of the least squares or rectangles to contain the opening in question. In case of double doors, the superficial area of chowkat shall be included in one door only.

12.4.3 Rates

12.4.3.1 Labour Rate

- a. The unit rate shall include the cost of labour involved in making and erecting doors and windows of the specified sizes complete in all respects, with fittings and furniture according to above specifications in specified places.
- b. The rate shall also include the use of ladders, support, staging and scaffolding for executing woodwork according to above specifications.
- c. The rate shall further include the cost of labour involved in applying two coats of wood preservatives on the chowkats.

12.4.3.2 Composite Rate

The unit rate shall include the cost of all materials supplied at site in addition to the labour rate as detailed in Heading 12.4.3.1.

12.5 Ledged and Braced Doors and Windows

12.5.1 Construction Requirements

12.5.1.1 Frame of Leaf

Ledged and braced door leaf shall be formed with battens secured to three ledges, with two braces between the ledges. Windows shall have only two ledges and one brace.

The top edges and ends of ledges and braces shall be chamfered. Battens (planks) shall have rebated joints finished with a "V" on one side and shall be of a uniform width of not more than 5 inches. The battens shall be screwed, with two screws at each end and one over each brace and the middle ledge.

12.5.1.2 Double Leaves

In the case of double doors, a 3" x 1" cover bar shall be screwed on to the edge of one leaf so as to make it a master leaf.

12.5.1.3 Hanging

The chowkat shall be rebated to a depth equal to the full thickness of the door, i.e. the battens plus ledges. The doors shall be hung with the battens inside and the ledges; outside. Hinges shall be fixed to the ledges.

12.5.1.4 Other Respect

In all other respects it shall conform to Specification for Doors and Windows (General).

12.5.2 Measurement

The measurement shall be done by the superficial area of the clear opening in brickwork or masonry. In case of circular or other similar joinery, measurement shall be taken of the net area. In the absence of any special rate being paid, measurement shall be taken of the least squares or rectangles to contain the opening in question. In case of double doors, the superficial area of chowkat shall be included in one door only.

12.5.3 Rates

12.5.3.1 Labour Rate

- a. The unit rate shall include the cost of labour involved in making and erecting doors and windows of the specified sizes complete in all respects, with fittings and furniture according to above specifications in specified places.
- b. The rate shall also include the use of ladders, support, staging and scaffolding for executing woodwork according to above specifications.

- c. The rate shall further include the cost of labour involved in applying two coats of wood preservatives on the chowkats.

12.5.3.2 Composite Rate

The unit rate shall include the cost of all materials supplied at site in addition to the labour rate as detailed in Heading 12.5.3.1.

12.6 Ledged Doors and Windows

12.6.1 Construction Requirements

12.6.1.1 Frame of Leaf

Ledged type also called country doors and windows, shall be formed by fixing battens on to three ledges. The battens shall be of uniform width, not more than 9 inches, and shall have rebated joints. Unless otherwise specified the thickness of battens and the ledges shall be as specified in the specifications.

12.6.1.2 Erection

Country doors shall be hung on pivot with the battens outside and ledges inside.

12.6.1.3 Other Respects

In all other respects the ledged doors and windows shall conform to Specification for ledged. Braced and Battened Doors.

12.6.2 Measurements

The measurement shall be done by the superficial area of the clear opening in brickwork or masonry. In case of circular or other similar joinery, measurement shall be taken of the net area. In the absence of any special rate being paid, measurement shall be taken of the least squares or rectangles to contain the opening in question. In case of double doors, the superficial area of chowkat shall be included in one door only.

12.6.3 Rates

12.6.3.1 Labour Rate

- a. The unit rate shall include the cost of labour involved in making and erecting doors and windows of the specified sizes complete in all respects, with fittings and furniture according to above specifications in specified places.
- b. The rate shall also include the use of ladders, support, staging and scaffolding for executing woodwork according to above specifications.
- c. The rate shall further include the cost of labour involved in applying two coats of wood preservatives on the chowkats.

12.6.3.2 Composite Rate

The unit rate shall include the cost of all materials supplied at site in addition to the labour rate as detailed in Heading 12.6.3.1.

12.7 Clerestory Windows

12.7.1 Construction Requirements

12.7.1.1 Chowkats

Unless otherwise specified the chowkats of clerestory window shall be so fixed as to project $\frac{3}{8}$ - inch from the inner face of the wall.

12.7.1.2 Cleat

Unless otherwise specified brass cleats or the slanting single button type approved by the Engineer-in-charge shall be fixed by two brass screws to the polished wooden teak blocks with chamfered edges. The wooden blocks shall be 2" x 3 $\frac{1}{2}$ " x $\frac{3}{4}$ " and shall be firmly fixed to the wall by means of plugs and screws of an approved type.

12.7.1.3 Leaves

The leaves shall be hung 1-inch off centre so as to make them self-closing. In order to open them, a cord (stout, non-twisting picture cord) shall be provided with a hard wood weight at one end (to keep the cord in position over the cleat).

12.7.1.4 Other Respects

In all other respects it shall conform to Specification for Glazed and Paneled Windows.

12.7.2 Measurements

The measurement shall be done by the superficial area of the clear opening in brickwork or masonry. In case of circular or other similar joinery, measurement shall be taken of the net area. In the absence of any special rate being paid, measurement shall be taken of the least squares or rectangles to contain the opening in question. In case of double doors, the superficial area of chowkat shall be included in one door only.

12.7.3 Rates

12.7.3.1 Labour Rate

- a. The unit rate shall include the cost of labour involved in making and erecting doors and windows of the specified sizes complete in all respects, with fittings and furniture according to above specifications in specified places.
- b. The rate shall also include the use of ladders, support, staging and scaffolding for executing woodwork according to above specifications.
- c. The rate shall further include the cost of labour involved in applying two coats of wood preservatives on the chowkats.

12.7.3.2 Composite Rate

The unit rate shall include the cost of all materials supplied at site in addition to the labour rate as detailed in Heading 12.7.3.1.

12.8 Wire Gauzed Doors

12.8.1 Material Requirement

12.8.1.1 Material

Unless otherwise specified leaves of wire gauze doors shall be made from deodar, irrespective of the wood used in making the chowkats or the other leaves hung from the same chowkat.

12.8.1.2 Timber

12.8.1.3 Chowkat

Wire gauzed doors shall normally be hung on the same chowkat as other doors, and the rate shall include the provision of extra depth in the chowkat to take the rebate for the wire gauze leaf. Where wire gauze doors are hung on a separate chowkat a special rate shall be settled.

12.8.1.4 Wire Gauze

Unless otherwise specified wire gauze shall be of best quality and uniformly woven wire webbing 12x12 meshes to squarer inch made from 22-gauge galvanized iron wire. All wire gauze panels shall be in one piece, no joints being allowed in the gauze.

12.8.2 Construction Requirements

12.8.2.1 Fixing

Wire gauze shall be fixed to the frame of the leaf after being stretched from out to out of rebate and nailed down taut by nails spaced at not more than 2 inches and then fixed that by a fillet of $\frac{3}{4}$ -inch x $\frac{3}{4}$ -inch screwed into a rebate of that size. The screws shall not be less than $1\frac{1}{4}$ -inches in length, nor spaced further than 9 inches. All exposed arises of the fillet shall be finished with a small neat mould.

12.8.2.2 Spring Hinges

Unless otherwise specified all wire-gauze doors shall be hung on self-closing spring hinges which shall be of an approved quality.

12.8.2.3 Double Doors to Project

All double leaf wire gauze doors shall close with the meeting stiles butting against each other, a felt or newer strip being fixed to one leaf to close the joint. The leaves shall close to such an extent that junction projects from the face of the chowkat, the projection being one inch for each foot width of leaf. The top of the chowkat (and sill when it has been provided) shall be enlarged to a corresponding wedge shape, the cost of this being included in the rate.

12.8.2.4 Matching Inner Leaves

Unless otherwise specified, the width, and position of lock and bottom rails on wire gauze, doors shall be the satire type as those of the other leaves hung on the same chowkat.

12.8.3 Measurements

The measurement of doors shall be done by the superficial area of the clear opening in brickwork or masonry. In case of circular or other similar joinery, measurement shall be taken of the net area. In the absence of any special rate being paid, measurement shall be taken of the least squares or rectangles to contain the opening in question. In case of double doors, the superficial area of chowkat shall be included in one door only.

12.8.4 Rates

12.8.4.1 Labour Rate

- a. The unit rate shall include the cost of labour involved in making and erecting doors and windows of the specified sizes complete in all respects, with fittings and furniture according to above specifications in specified places.
- b. The rate shall also include the use of ladders, support, staging and scaffolding for executing woodwork according to above specifications.
- c. The rate shall further include the cost of labour involved in applying two coats of wood preservatives on the chowkats.

12.8.4.2 Composite Rate

The unit rate shall include the cost of all materials supplied at site in addition to the labour rate as detailed in Heading 12.8.4.1.

12.9 Wire Gauzed Windows

12.9.1 Construction Requirements

- a. Where moveable wire gauze flaps or leaves are provided to windows, Specifications for Wire Gauzed Doors shall be followed with the following modifications.
- b. Wire gauze windows shall not be provided with springs or spring hinges.
- c. Double hung wire gauze windows shall close flush with the chowkat without the meeting stiles projecting in any way.
- d. Unless otherwise specified wire gauzed windows shall open outwards and shall be provided with hinged chocks to keep them in the open position, and with stops to prevent damage to plaster.

12.10 Wire Gauzed Clerestory Windows

12.10.1 Construction Requirements

- a. Unless otherwise specified, wire gauzed leaves for clerestory windows shall be hung on a separate chowkat set back 1-inch from the outer face of the wall (the glazed window being fixed in a separate chowkat, flush with inner face). The leaf shall be hung from the top, so as to close by its own weight and shall swing outwards. In all other respects, the Specifications for Wire Gauze Windows shall be followed.
- b. The cost of the chowkat shall be included in the rate, the measurement being out to out of chowkat.

12.11 Fixed Wire Gauzed

12.11.1 Construction Requirements

12.11.1.1 Wire Gauze

Unless otherwise specified, the wire gauze shall be of an approved quality, uniformly woven, wire webbing of 12x12 meshes to a square inch made from 22-gauge galvanized iron wire. All panels shall be in one piece and no joints shall be allowed in the gauze.

12.11.1.2 Method of Fixing

Wire gauze shall be fixed to the outside of the chowkat. This shall be drawn taut to the full width of the chowkat and nailed down by nails spaced not more than 2 inches and a cover strip. $\frac{3}{4}$ -inch in thickness and of the same width as the chowkat so as to seem a part of the chowkat, fixed all round with $1\frac{1}{4}$ -inch screws fixed not more than 9 inches apart.

12.11.1.3 Alternative Method

If specially required by the Engineer-in-charge, the wire gauze shall be fixed to the chowkat by a fillet, $\frac{3}{4}$ -inch x $\frac{3}{4}$ -inch, screwed into a rebate of the same size. The wire gauze shall be stretched taut and nailed down by nails spaced not more than 2-inches to, the chowkat, and then the fillet screwed down with 1-inch screws spaced not more than 9 inches apart.

12.11.2 Fixing Rates

Exposed arises shall be finished with a small but neat mould in each case. The rate shall be same for either method of fixing.

12.12 Glazing

12.12.1 Construction Requirements

12.12.1.1 Glass, thickness and Quality

Unless otherwise specified, all glass shall be flat sheet glass of fine quality and of the following weights per square foot for the various sizes mentioned below:

- Not exceeding 12" x 14" - 16 oz (about 1/14" thick)
- Exceeding 12" x 14" but not exceeding 24"x 24" - 21 oz (1/10" thick)
- Exceeding 24" x 24" but not exceeding 30"x 30" - 26 oz (1/9" thick)
- Exceeding 30" x 30" but not exceeding 36"x 36" - 32 oz (1/7" thick)
- Exceeding 36" x 36" plate glass (1/4" thick)

Glass shall be free from specks, bubbles, distortion and flaws of every kind, and shall be properly cut to fit the rebates, so as to leave a uniform space of 1/16-inch all-round the panes between the edge of the glass and the rebate.

12.12.1.2 Putty

Putty shall be prepared from pure raw linseed oil and best whiting, especially dry and ground line to pass a sieve of 45x45 meshes to a square-inch. The two shall be well mixed by hand and kneaded into a stiff paste. It shall then be left for 12 hours and worked up in small pieces till it becomes quite smooth. If the putty becomes dry, it shall be restored by heating and working it up again while hot. Where the rebate is small a little white lead shall be added in making the putty. Putty required for glazing large panes or for bedding plate glass shall be made with a mixture of linseed oil and tallow with whiting so as to make it pliable and capable of standing expansion of the panes. Where required, putty shall be coloured to match the wood work.

12.12.1.3 Painting or Priming Rebates

If rebates have not been painted, they shall be well primed with boiled linseed oil to prevent the wood from drawing oil out of the putty. Putty shall be painted at the same time and the same number of coats as wood work.

12.12.1.4 Fixing Glass with Putty

Each pane of glass shall then be bedded on a thin layer of putty called "back putty" and secured into position with proper glazing springs or nails. "Front putty" shall then be applied chamfered and finished off neatly so as to ensure that the depth of the putty is exactly equal to the rebate.

12.12.1.5 Fixing Glass with Wood Fillets

In the case of all panes exceeding 12 inches in width, front putty shall not be used by the glass secured with fillets of wood, without extra charge. The fillets shall be plain or moulded and of a size depending on the type of door being glazed. The glass shall be protected from contact with the wood by putty made with tallow to act as a cushion.

12.12.1.6 Blind glass

When blind glass is fixed the frosted face shall be away from the putty.

12.12.1.7 Putty (Coming Off)

All glass that has been fixed by the contractor shall if it becomes loose during the period specified in the contract, be re-fixed and puttied by him at his own expense.

12.12.1.8 Cleaning and Finishing

No glazing shall be considered complete until all paint and other stains have been removed from the surface of the glass. Glass shall be cleaned and polished with pads or damp newspaper, and then with a clean dry soil cloth (unsized). Cleaning shall be done by two men working on opposite sides of the same pane at the same time. The contractor shall make good all glass broken by his workers while cleaning the glass. On completion of the work all doors and windows shall be cleaned, damaged putty or glazing repaired and the whole work left perfect with a workmanlike finish.

12.12.2 Measurement

In measuring glazier's work all, fractional parts under half an inch shall be omitted and all above that taken as one inch. Curved or irregularly shaped pieces shall be measured as the least rectangle from which that can be cut. Measurement shall be made net from inside to inside of rebate. The unit of measurement shall be one square foot or one square meter.

12.12.3 Rates**12.12.3.1 Labour Rate**

The unit rate shall include the cost of labour involved in carrying out glazing in accordance with above specifications. It shall also include provision of all tools and plant required for glazing. It shall further include removal of all ladders, scaffoldings, staging and supports required for glazing.

12.12.3.2 Composite Rate

The unit rate shall include cost of all materials required for glazing supplied at site of work in addition to the labour rate as detailed in Heading 12.12.3.1.

12.13 Wooden Floors**12.13.1 Construction Requirements****12.13.1.1 Floor Bearers, Ground Floors**

In the case of ground floors, floor joists (bridging joists) shall rest on pillars, dwarf walls, rails or beams as may be specified.

The plinth under the flooring shall be excavated to the depth specified by the Engineer-in-charge and dressed level and rammed. If directed, a layer of lime concrete shall be laid as specified under "concrete", otherwise dwarf walls or pillars shall be built on a lime concrete

foundation. The dimensions and spacing shall be as indicated in the drawings or otherwise directed by the Engineer-in-charge.

12.13.1.2 Floor Bearers, Suspended Floors

In the case of upper floors, the bridging joists shall rest on wall plates, beams, rails or on other joists as shown on the drawings or otherwise directed by the Engineer-in-charge.

12.13.1.3 Floors Bearers, Material and Fixing

The timber for the floor joists shall be of the kind specified in accordance with the general specification for wood work. The full number of joists for each continuous floor shall be laid and dressed to one level and tested before flooring begins.

12.13.1.4 Preservatives

All joists, wall plates, bearers, and the underside of plunking shall be given two coats of hot wood preservative such as creosote or coal tar, as directed by the Engineer-in-charge: The rate does not include this work, and shall be paid for separately according to the rates for painting with these materials.

12.13.1.5 Boarding, Materials and Size

The boarding for the floor shall not be placed on the underside in the case of ground floor and suspended floors to be coiled. Unless otherwise specified or shown on the, drawings, in the case of deodar, kail or chir-wood, the boards or battens shall be inch thick, not more than 6 inches wide and not more than 10 feet long. In the case of teak, they shall be 1-inch thick. 4-inches wide and as long as possible. No board shall be less than 6 feet long, the ends being truly squared up after any split portion has been sawn off. All boards shall be uniform and parallel in width and of the same thickness.

12.13.1.6 Joints

The planks shall be planed true on one side (on both sides for un-ceiled upper floors) the edges to be planed, rebated or tongued and grooved, as directed by the Engineer-in-charge. Unless otherwise specified the edges shall be tongued and grooved, with concealed joints for teak wood floors and rebated joints for other floors.

12.13.1.7 Planking (Method of Laying)

The outer lines of boarding shall be accurately fixed parallel and close to the wall. Each subsequent line shall have the side joints carefully joined up, and shall then be cramped into position by floor cramps, and nailed or screwed as specified, so that the heads shall be sunk below the finished surface of floor, or otherwise fixed with "secret joints". The cramps shall not be removed until the nails or screws have been fixed. The ends of planks shall rest on the centre of a joist and the ends of no two adjacent planks shall be the same joist. Paved floors shall be stopped under a brass strip screwed to wooden floors where the two meets.

12.13.1.8 Nails and screws

Nails and screws shall be subject to the approval of the Engineer-in-charge and shall be in length at least twice the thickness of the plank, two being used at each end and one at every intermediate joist alternately on opposite sides of the plank. All screws shall be oiled before they are inserted.

12.13.1.9 Planning

After the floor has been laid, it shall be planed in both directions and made perfectly smooth. All depressions in the wood, nail holes and small defects of every kind, where permitted by the Engineer-in-charge to remain in the work, shall, unless otherwise specified, be filled with "Beau montage" or stopped out wax conforming to Specification.

12.13.2 Measurements

The measurement of wood flooring shall be done by superficial area. The unit of measurement shall be 100 square feet.

12.13.3 Rates and Payments

The unit rate shall include the floor boarding laid and fixed in position and planed in both directions, provision of brass screws in the case of teak wood floor where concealed, fixing is not employed. The operation like sand papering, oiling, waxing, staining or varnishing are not covered and shall be paid for separately. The unit rate does not include joists, wall plates, bearers, rolled steel joists, rails, concrete or masonry pillars and payment for these shall be made separately.

12.14 Wooden Joinery

12.14.1 Conformity to Standard

Except as otherwise specified, work under this section shall conform to relevant British Standards as applicable to work. or equivalent ASTM standard, or as deemed appropriate by Engineer in Charge or his Representative.

12.14.2 Materials

12.14.2.1 Timber

It shall conform to the applicable requirements of BS-1186 "Quality of Timber and Workmanship in Joinery" Part-1 'Quality of Timber' or as required by Engineer in Charge or his Representative.

Timber shall be well seasoned, uniform in substance and color, free from large or dead knots, cross grains, winds, shakes. cracks or other blemishes. The fiber shall be straight and smooth and shall not give a dull appearance.

Conform to the applicable requirements of BS-1455 "British made Plywood" for workmanship and quality or as required by Engineer-in-Charge or his Representative. Unless otherwise required or shown on the drawing the thickness of the plywood shall be Wood and shall be Teak, Sheesham or commercial veneered for all exposed faces as given in BOQ or on drawings.

12.14.2.2 Paneling Boards

Where called for in the BOQ or shown on the drawing, paneling boards shall be factory-pressed boards of required thickness with Teak or Sheesham veneer on the exposed face and commercial ply on the back, with high density particle board in - between, as specified and approved by Engineer-in-Charge or his Representative. Edges and ends of boards where visible shall be provided with a veneer of matching grain and quality.

12.14.2.3 Formica

It shall be of required shade and pattern and of best quality as approved by Engineer-in-Charge or his Representative.

12.14.2.4 Flush Doors

It shall conform to BS-459 "Flush Wood Doors' and Code of Practice CP-151 Flush Wood Doors" or as required by Engineer in Charge or his Representative.

12.14.2.5 Fixing Accessories

Fixing accessories shall conform to the requirements of applicable British Specifications in particular:

- BS-325 "Black Counter Sunk Nuts and Washers".
- BS-916 'Bolts, Screws and Nuts" BS-I210 "Wood Screws".
- BS-1494 "Fixing Accessories for Building Purposes".
- BS-1202 "Wire Nails and Cut Nails for Building Purposes".

Or shall confirm to equivalent ASTM standard, or as directed by Engineer-in-Charge or his Representative.

12.14.2.6 Wire Gauze

- i. Unless otherwise specified in BOQ it shall be of best quality uniformly woven wire webbing 12x12 mesh per sq. is made from 22-gauge galvanized iron wire. All wire gauze panels shall be in one piece, no joint being allowed in the gauze.
- ii. **Wood Preservative:** shall be creosote or pentachlorophenol and shall conform to the applicable requirements of BS-1266 "Classification of Wood Preservatives and their method of application", or shall conform to applicable ASTM standard.

12.14.2.7 Glue

- i. It shall conform to the applicable requirement of BS-745 "Animal Glue for wood" or BS-1204 "Synthetic Resin (Phenolic and Amine Plastic) Adhesives for construction work in Wood", or as directed by Engineer-in-Charge or his Representative.
- ii. Putty shall be an elastic glazing compound suitable for interior and exterior glazing and shall conform to the requirements of BS-544 "Linseed oil putty for use in wooden frames" or as required by Engineer-in-Charge or his Representative. The putty for metal frames shall be of a type specially prepared for use with metal frames conforming to the applicable requirements of the BS or of a make approved by Engineer-in-Charge or his Representative.
- iii. Paint shall be as specified in Chapter-13 of Book-2 "Painting and Varnishing".

12.14.2.8 Glass

- i. Glazing, clear or frosted, shall be in conformity with requirements of BS: CP-152 "Glazing and fixing of glass for buildings" and BS-952, or equivalent ASTM standard or as directed by Engineer-in-Charge or his Representative.
- ii. All glass used shall be even, free from specks, bubbles, tints, distortion and flaws or every kind.
- iii. Unless otherwise specified in the BOQs, the glass shall conform to weights per sft. for various sizes as below:
 - Not exceeding 12"x 14" - 16 oz (about 1/14" thick).
 - Exceeding 12" x 14" but not exceeding 24"x 24" - 21 oz (1/10" thick)
 - Exceeding 24" x 24" but not exceeding 30"x 30" - 26 oz (1/9" thick)
 - Exceeding 30" x 30" but not exceeding 36"x 36" - 32 oz (1/7" thick)
 - Exceeding 36" x 36" plate glass (1/4" thick)
- iv. Weight of glass as required for the largest panel in any unit of door or window, etc. shall be employed in all panels irrespective of their size.

Hardware shall be of best quality and make of approved manufacture. Their sizes, materials and number shall be as detailed in the drawings/BOQs.

12.14.2.9 Samples

- i. Samples of material used for the work under this section shall be submitted for approval by Engineer-in-Charge or his Representative and same type of material shall be used throughout the work. If Engineer-in-Charge or his Representative require the material to be tested, this shall be got done by the Contractor, at his own cost from a Laboratory approved by Engineer in Charge or his Representative.
- ii. Any material rejected by Engineer-in-Charge or his Representative shall be removed from the site immediately.

12.14.3 Workmanship

12.14.3.1 General

- i. Wood work shall be neatly and truly finished to exact dimensions and details as shown on the drawings. All joints shall be simple tenon and mortise joints unless otherwise specified or directed by Engineer-in-Charge or his Representative, and shall fit truly and fully. Holes of correct size shall be drilled before inserting screws.
- ii. Driving in or starting in screws with hammer shall not be allowed. All screws shall be dipped in oil before being inserted in correct size holes which shall be drilled for the purpose. All portions of timber, built into or against masonry or concrete or used as sub-frame for railing or paneling, shall be treated with wood preservative as specified.
- iii. If after the wood work has been erected, any undue shrinkage, distortion or bad workmanship is discovered the Contractor shall forthwith replace or amend the same without any extra charge, to the satisfaction of Engineer in Charge or his Representative.

12.14.3.2 Frames for Doors, Windows etc.

Door and window frames shall conform to the applicable requirements of BS-1567 "MS frames" or as directed by Engineer-in-Charge or his Representative. The doorframes shall be of best quality specified Mild Steel and shall be fabricated to exact size and dimensions as shown in the drawings. The vertical members of frames shall be embedded in floors at least 2' deep for which extra length no extra payment shall be made. Frames shall have rebate to receive the leaves as shown on the drawings: The frames shall be suitably secured to the brickwork or concrete by holdfasts or expansion bolts as shown on the drawings or as approved by Engineer-in-Charge or his Representative. Stop shall be of best quality timber of the same specification as that for frames.

12.14.3.3 Paneled Doors & Windows

- i. It shall conform to the applicable requirements of BS-459 'Paneled and Glazed Wood Doors' Part-I and BS: CP-151 Part-I or as directed by Engineer-in-Charge or his Representative.
- ii. Doors shall be of best quality well-seasoned Deodar Wood or the timber specified. Panels shall be of solid wood, veneered ply-wood, or glass as indicated in the drawings.
- iii. Stiles, rails and beads shall be of well-seasoned best quality specified wood.
- iv. Flush Doors shall conform to the applicable requirements of BS-459 "Flush Wood Doors" and BS: CP-151 or as required by Engineer in Charge or his Representative. Door leaf shall be of well-seasoned solid core of Deodar wood block board cross grained and face veneered with 5-ply 6mm thick plywood of specified finish on each side. Door leaf shall have an inner frame and well-seasoned edge strips of quality and design shown on drawings on all four edges of leaf. Face veneers shall be free of saps, streaks, knots and irregularities and shall be suitable for taking required finish. Veneer construction shall provide for equal stress on both sides to ensure absence of warp. Flush doors shall be screwed to the frames by means of hinges which shall be counter sunk in the wooden frames.

12.14.3.4 Wire-gauzed Doors and Windows

They shall be of size and design as shown in drawings or indicated in BOQ. Wire gauze shall be fixed to the frame of the leaf after being stretched from out to out or rebate and fixed taut. The screw shall not be less than 1.25" in length nor spaced farther than 9". All exposed arises of the fillet shall be finished with a small neat mould.

12.14.3.5 Glazing

All glazing work shall be carried out in conformity with BS: CP 152 or as directed by Engineer-in-Charge or his Representative. Glass will be fixed after first coat of paint or polish has been applied.

Glass shall be fixed with best quality putty, wood or steel moulding as required. Glass shall be protected against damage. After inspection, any labels and paint spots shall be removed from the glass and glass shall be washed clean. Damaged or broken glass shall be removed and replaced by the Contractor at his own expense.

12.14.3.6 Paneling

It shall be of well-seasoned best quality required wood. Unless otherwise indicated in BOQ or drawings, the planks shall be 'W' thick. Deodar wood battens shall be screwed to hard wood plugs fixed in slab or wall creosoted before fixing as specified. Deodar wood panels shall be screwed to the Deodar wood under-frame as shown on the drawings. Deodar wood beading shall be provided wherever indicated on the drawings. Panels shall be so fixed that a uniform surface with equal gaps or joints results in a pleasing appearance.

12.14.3.7 Wood Handrails

It shall be of best quality well-seasoned wood. Handrails shall be accurately shaped to detail and made in as long sections as possible.

Joint shall be fastened with concealed handrail bolts. All changes in direction shall be smooth, even, carved out of one solid piece. Handrails shall be secured to metal railing with 114 x 2" screws at 12" centers.

12.14.3.8 Sub-frames for wall paneling, wood floors & cat-walks

They shall be of best quality Deodar wood, of sizes as shown on drawings and securely fixed in position using hard wood plugs, bolts etc. using enough number of nails, screws etc. as specified and directed by Engineer-in-Charge or his Representative. The timber members shall be given 2-coats of wood preservative before they are installed in position.

12.14.3.9 Hardware

It shall be carefully fitted and securely attached. Upon completion of the work all locks and hinges shall be oiled and all hardware shall be demonstrated to work freely in the presence of Engineer-in-Charge or his Representative. Key shall be lilted into their locks and upon acceptance of the work, keys shall be tagged and delivered to Engineer in Charge or his Representative.

12.14.4 Painting

- i. All wooden doors, windows, paneling etc. shall be painted or polished as required, and as specified in Chapter-13 of Book-2 "Painting and Varnishing".
- ii. Hard woods shall be polished and soft woods shall be painted.

12.14.5 Measurement

12.14.5.1 General Wood Work

- i. The measurement of wood work (general) or planking shall be the net measurement after fixing in position, no allowance being made for waste, overlaps, rebates or the dimensions supplied beyond those specified.

- ii. The length of each piece. however, shall be taken overall so as to include projection for tenons or scarfs. Measurement shall be made by superficial area, volume or length as given in BOQ.

12.14.5.2 Doors & Windows

- i. These shall be measured by the superficial area of the clear opening in brick work or masonry, no allowance being made for overlaps, architraves, headings and the like; except that in case of doors having frames on two sides only with a void at bottom between the floor and the leaf, height shall be the leaf height. In case of any special rate being paid. measurement shall be taken of the least squares or rectangles to contain the opening in question.
- ii. Fixed wire-gauze and wire-gauze leaves shall not be measured for separate payment.

12.14.5.3 Wood Hand Rails

It shall be measured by length. Metal work (Balustrades. Anchors etc.) shall be measured and paid under Chapter "IRON WORK".

12.14.6 Rates and Payments

- a. The rate and prices shall be full compensation for everything furnished and done for the work item installed/fixed complete in all respects, and as per these specifications, drawings, instructions of Engineer-in-Charge or his Representative and Conditions of Contract. It should be specifically noted that the rates are also inclusive of the following:
- b. Hardware per Hardware Schedule; hold fasts, plugs, fixed wire gauze or wire gauze shutters; architraves, stops, beadings, mouldings, tower bolts and mortice locks (Japan made) etc. all as shown on the drawings and as specified.
- c. Finishing (painting, polishing etc.) wood preservatives as specified in Chapter-13 of Book-2 "Painting and Varnishing".
- d. Glass and glazing, as per drawings and BOQs or as directed by the Engineer-in-Charge.

12.15 Aluminum Joinery

12.15.1 Scope

The work under this section of specifications includes finishing all labour, equipment, appliances and material and performing all operations in carrying out the aluminum works for windows, doors, ventilators and louvers. All related items such as sealants, rubber, gaskets for glazing, netting, rollers, latches, fastening, anchor bolts and all other items supplied by trades and customarily built in and / or installed in strict accordance with this section of specifications and applicable drawings and subject to the terms and conditions of the contract.

12.15.2 General

Doors and windows to be provided shall be aluminum of profile pattern and design shown on drawing and shop drawings, manufactured by reputable manufacturer approved by the Engineer-in-charge. The contractor shall provide manufacture literature completely describing the product instructions for installation and maintenance.

All the sections used for doors, windows, ventilators and ply screens shall of best quality aluminum product such as equal and unequal angles, channels, tubes, corrugated strips, moldings etc. in accordance with the international standards conforming to ASTM B 303 and B 221.

All doors and windows and ventilators shall be of the type and sizes indicated on the drawings and conform to the requirement shown and specified therein.

Contractor shall arrange test and analyze. If directed by the engineer, skilled models of each door, window and ventilator type at the makers works or any laboratory specified by the engineer for the material supplied by him to be tested in the presence of the engineer's inspector to whom test certificates, proof sheets etc. shall be furnished. The model shall be submitted to the engineer' for approval and to be tested in the presence of the Inspector and the contractor shall wait for the result to be obtained from the laboratory and shall fix the doors and windows, ventilators etc. only once a formal approval is given by the Engineer-in-Charge. If the delivery of the material found is not in accordance with these specifications the work shall be rejected and another sample asked for by the engineer to retest and approval.

After approval of the shop drawings and tests etc. the contractor shall submit at his own cost one mock-up sample of each type of aluminum work complete with glazing. All components, assembly method, required fittings- and accessories prior to the actual fabrication of the bulk. The samples shall be returned to the contractor for incorporation in the works after installation of at least 80% of the work.

Fabricate and assemble all work in the shop of the approved manufacturer to reduce field fabrication at the minimum unless otherwise directed by the engineer.

The glass shall conform to the specification's laid down under chapter-15 on "Glass" in Book-1. to these specifications. Glass shall be free from all blemishes, bubbles, distortions and other flaws of any kind and shall be properly cut to sizes as shown on the relevant drawing so as to fit the grooves and window members.

The structural shape of the aluminum members shall be uniform quality colour and temper, clean, round, commercially straight and free from injurious defects.

All doors and windows shall be fabricated as a complete obit fully airtight and watertight including rubber gaskets for glazing, rollers, latches, anodized in specified colours inclusive of glass sheet necessary holes for fixing, door locks, door closures and windows locking requirement, all approved by the engineer.

12.15.3 Material Requirements

The frames of anodized aluminum door windows ventilators and louvers shall be formed from rolled strip or extruded aluminum and at least 1.8 mm thick or as specified in the drawings

approved by the Engineer-in-charge. Fastening bolts and screws shall be made from hardened aluminum.

If shown on the drawings, aluminum frames shall be provided as per international standards approved by the engineer.

Fasteners shall be of stainless steel of a type selected to prevent galvanic action with the components fastened.

Gaskets shall be vinyl glazing channel gasket to commercial standards CS-230-60.

Hardware shall be manufacturer's standards hardware flush to match door windows and ventilators finish.

Joint sealant shall be approved by the engineer.

All aluminum sections shall be 2 mm thick and the finish shall be bronze anodized in accordance with the standards of Aluminum Association. The 'anodization' shall be of not less than 25-micron thickness.

12.15.4 Workmanship

The contractor shall be responsible for the protection and installation of all items furnished. All items shall be installed plumb and square and shall be solidly anchored in a good workmanship like manner and in accordance with the manufacturer's instruction and/or as specified therein on the drawings. The contractor shall be responsible for the protection of installed items from damage by other trades. All items shall be left in operating, neat and clean condition, free from dirt, finger marks etc. The contractor shall be responsible for the final cleaning before the final acceptance.

The glass panes shall firmly be secured in the rubber rebates with the rubber gaskets. Ensure that the beads and grooves are clean, dry and unobstructed at the time of glazing. The complete unit shall be airtight and watertight on completion. No door, window and ventilator shall be considered a complete unit unless the finger prints/other stains or marks have been removed from the surface of glass and aluminum.

12.15.5 Product, Delivery and Storage

The contractor shall deliver doors, windows, ventilators and louvers in a manner preventing damage to units; and store material off the ground under cover in a manner preventing deterioration or damage.

All embedded parts and anchor bolts shall be delivered to the site carefully and keeping the fabricated shape and configuration. All these parts shall be suitably marked for identification.

All raw plugs and anchoring bolts shall be embedded in the concrete or block masonry for holding the doors, windows, ventilators and louvers in their correct positions.

Care shall be taken to install the doors, windows and ventilators in line and plumb and solidly anchored in a good workman like manner in accordance with the drawings. Should any discrepancy appear on the surfaces of doors, windows, and ventilators, the surfaces cleaned to bare bright pacified colour.

All works shall be installed in strict accordance with the manufacturers printed instructions.

12.15.6 Protection and Cleaning

Temporary protection shall be achieved by applying water soluble protective coating capable withstanding the action of lime mortar.

Apply coating in the manufacturers plan to the exposed surface of all components.

Before application of coatings remove all fabrication compounds.

12.15.7 Defective Work

In the event of non-conforming to specifications and drawings, the aluminum work shall be rejected by the engineer and the contractor shall remove and replace works by new work specifications.

12.16 Cladding

12.16.1 Brick Cladding

12.16.1.1 Description

This specification covers providing and laying brick cladding of specified size in 1:3 Cement sand mortar using red posso mortar (1-part cement and 3 parts surkhi) including filling the space between wall and cladding using 1:5 cement sand mortar including cost of steel nails 6" long @ 2'-0" c/c horizontally and vertically, cutting bricks as per drawing and site requirements as directed by the Engineer-in-charge.

12.16.1.2 Materials

12.16.1.2.1 Cladding Unit

It shall conform to Heading 6 & 7 of these specifications except size.

12.16.1.2.2 Gutka Size

2- $\frac{1}{4}$ " x 2- $\frac{1}{4}$ " x 9"
2- $\frac{1}{4}$ " x 3" x 9"
2- $\frac{1}{4}$ " x 1- $\frac{1}{2}$ " x 9"

12.16.1.2.3 Brick Size

1- $\frac{1}{2}$ " x 1- $\frac{1}{2}$ " x 9"
4- $\frac{1}{2}$ " x 3" x 9"

12.16.1.2.4 Water

Water shall conform to the provision and requirement set forth in Chapter-2 of Book-1 of these specifications.

12.16.1.2.5 Mortar

It shall conform to Chapter-5 of Book-2 of these specifications.

12.16.1.3 All Other Respects

In other respects, it shall conform to Chapter-7 of Book-2 of the specifications.

12.16.1.4 Measurements

The brick cladding will be measured in superficial area. The unit of measurements shall be 1sft.

12.16.1.5 Rate

12.16.1.5.1 Labour Rate

The unit rate (on labour rate basis) for cladding shall include the cost of carrying out cladding work, cutting gutka or bricks as the case may be, wherever required, curing, using and removing scaffolding, shuttering, centering, staging, ladders, supports and other tools and plants required for carrying out the cladding work as per above specifications.

12.16.1.5.2 Composite Rate

The unit rate shall include the cost of cladding work, cement, sand, surkhi, steel nails 6" long and any other material required in addition to labour rate detailed above.

12.16.2 Wash Terrazzo

Providing and Laying Terrazzo wall finish ½" thick using one part of white cement and 2 parts of marble chips of specified gauge over ½" thick roughened surface of cement sand plaster ratio 1:3 including making panels as per site requirements by means of aluminum U-Channel ½" x 3/8" size and G.I. screws, fixed in plumb, straight and level and then washing with narial (Coir) brush and water to required extent complete in all respects.

12.16.2.1 Description

Unless otherwise specified wash terrazzo shall be laid in accordance with the following specifications:

- a. Marble chips shall be of approved grade, colour, size and quality.
- b. Cement shall conform to Chapter-3 of Book-1 of these specifications, coloured cement wherever used shall be of approved quality.
- c. Fine aggregate shall conform to Chapter-6 of Book-1 of these specifications.
- d. Water shall conform to Chapter-2 of Book-1 of these specifications.

12.16.2.2 Base

Unless otherwise specified plaster used for bottom layer shall be of the ratio 1:3 cement sand mortar.

12.16.2.3 Thickness

Unless otherwise specified the terrazzo, thickness shall not be less than ¾" and shall be laid monolithic with bottom layer of cement sand plaster of specified thickness.

12.16.2.4 Finishing of Bottom Layer

The bottom layer of cement sand plaster shall be roughened.

12.16.2.5 Dividing into Panels

For dividing wash terrazzo into panels Aluminum U-Channel ½" x ¾" size shall be fixed by means of screws on roughened surface. The U-Channel shall be fixed in such a manner that its top is in level with required finishing surface of wash terrazzo.

12.16.2.6 Laying

The bottom layer of cement sand plaster shall conform to heading 12.16.2.2 of these specifications with its surface made rough for adequate adhering of top terrazzo layer. After laying and curing of bottom layer Aluminum U-Channel $\frac{1}{2}$ " x $\frac{3}{8}$ ", unless otherwise specified, shall be fixed by means of screws according to site requirements for making panels. A terrazzo topping $\frac{3}{8}$ " to $\frac{3}{4}$ " thick consisting of one part of white cement or ordinary Portland cement as specified and 2 parts of marble chips, well mixed, is laid with trowel and float. In order to achieve good results water added to the mix shall be just sufficient to produce a workable plastic mix. Whichever method is adopted for terrazzo topping, not more than 70% of the surface should be covered with marble chippings. After sustaining of the material, it shall be washed with coir brush and water to required extent.

12.16.3 Porcelain / Ceramic Tile Cladding

12.16.3.1 Description

Providing and laying local porcelain/ceramic tile cladding using approved colour, design and pattern laid in white cement with pigment to match the colour and shade of ceramic tiles over a bed of roughened cement sand plaster in the ratio of 1:2, $\frac{3}{4}$ " thick including labour for cutting tiles according to site requirements, washing and cleaning top surface of tiles with detergent complete in all respects. Unless otherwise specified, porcelain/ceramic tile cladding work shall be executed in accordance with the Heading 12.16.3 of these specifications true to dimensions and pattern as shown on the drawing.

12.16.3.2 Materials

12.16.3.2.1 Porcelain / Ceramic Tiles

It shall conform to Chapter-5 of Book-1 of these specifications.

12.16.3.2.2 Water

Water shall conform to the provision and requirement set forth in Chapter-2 of Book-1 of these specifications.

12.16.3.2.3 Mortar

Cement: Sand mortar shall conform to Chapter-5 of Book-2 of these specifications.

12.16.3.3 Base

Unless otherwise specified cement sand plaster (1:2) as base on walls having thickness of $\frac{1}{2}$ " to $\frac{3}{4}$ " as specified, shall be provided with roughened surface. It shall conform to Cement Sand Plastering of these specifications.

12.16.3.4 Laying

After laying of base and proper curing the ceramic tiles cladding shall be laid using cement sand mortar (1:2), $\frac{3}{4}$ " thick and joints will be filled with white cement and pigment mortar.

12.16.3.5 Measurements

The ceramic tile cladding shall be measured in superficial area. The unit of measurement shall be 1-ft².

12.16.3.6 Rate

12.16.3.6.1 Labour Rate

The unit rate (on labour rate basis) shall include the cost of laying of porcelain/ceramic tiles, cutting tiles wherever required, curing, using and removing scaffolding, shuttering, centering, staging, ladders, supports and other tools and plants required for carrying out ceramic tile work on walls.

12.16.3.6.2 Composite Rate

The unit rate shall include the cost of porcelain/ceramic tiles, cement, sand, white cement, pigment and any other material required in addition to labour rate detailed above.

12.16.4 Cast Stone Cladding

12.16.4.1 Description

Providing and laying cast stone cladding of specified size, thickness, colour, texture and design over $\frac{3}{4}$ " thick cement sand mortar ratio (1:3) with pigment having joints $\frac{1}{2}$ " to $\frac{3}{8}$ " size filled with mortar of same material according to drawing and site requirements.

12.16.4.2 Materials

12.16.4.2.1 Cast stone

It shall conform to Chapter-7 of Book-1 of these specifications.

12.16.4.2.2 Water

Water shall conform to Chapter-2 of Book-1 of these specifications.

12.16.4.2.3 Mortar

Cement: Sand mortar of 1:3 ratio shall conform to Chapter-5 of Book-2 of these specifications.

12.16.4.3 Measurements

The cast stone cladding work shall be measured in superficial area. The unit of measurement shall be 1-ft².

12.16.4.4 Rate

12.16.4.4.1 Labour rate

The unit rate (on labour rate basis) shall include the cost of laying of cast stone cladding, cutting cast stone whenever required, curing, using and removing scaffolding, shuttering,

ladders, supports and other tools and plants required for carrying out cast stone cladding work on walls.

12.16.4.4.2 Composite rate

The unit rate shall include the cost of cast stone cladding, cement, sand, pigment and other materials required in addition to labour rate detailed above.

12.17 Door Closers

A door closer is a mechanically device that close a door, in general after someone opens it, or after it was automatically opened. Choosing of door closer can involve the consolidation of a variety of criteria. Choosing a door closer changes depending on many different as stated below.

- Size and weight of the door
- Location of the door
- Opening and closing frequency
- Mounting location
- Affordability
- Backswing requirements

12.17.1 Traffic Volume Considerations

In general, overhead door closers are used typically for medium- to heavy-traffic locations, and they are extremely durable. There are options for interior or exterior doors, and they're one of the most common types that are used.

Floor-spring or overhead spring closers, on the other hand, are a bit more durable, and they work nicely for heavy traffic doors. Additionally, they are not visible like overhead closers, making them one of the most attractive options. Finally, concealed and frame mounted closers are typically used for medium traffic, interior doors. Deciding on a door closer depends on a variety of factors. It starts with understanding the various types, and the benefits that they have to offer. Then, matching the door to the type of door closer that you're using is the key. Heavier doors and doors with higher traffic require durable, strong door closers. Lighter doors do not.

12.17.2 Building Code Considerations

Each area can have slightly different building codes depending on the location of the building. Federal, state, and even local building codes can have an impact on determining the door closer required. The Builders Hardware Manufacturers Association (BHMA) and American National Standards Institute (ANSI) provide extensive standards for door closers. The full list can be found here. Generally, each door closer needs to meet different levels of performance broken up in 3 grades with 1 being the highest and 3 being the basic level. Performance is judged based on cycle testing as well as closing force and finish tests. The tests are done in a neutral air pressure laboratory at 60-85 degrees F.

Door closers have the following requirements: -

- Grade 1: 2,000,000 cycles at 60% efficiency
- Grade 2: 1,000,000 cycles at 60% efficiency
- Grade 3: 500,000 cycles at 50% efficiency

If doors are being installed into a high-volume area like a major office building or hospitals etc., it is crucial to only use door closers that have been rated as Grade 1 closers. The American Disability Act also provides a list of clear requirements when looking at doors and door closers. The ADA states that interior doors should require no more than 5lbs of force to operate and exterior doors should have the minimum force possible. The ADA also states that

the closing or swing speed shall not be faster than 5 seconds and the latching speed should be quick enough to latch the door, but not slam it.

12.17.3 Aesthetic Considerations

A door closer might be chosen for its appearance, as some are more attractive than others. The majority of door closer units are adjustable, allowing operators to set a specific closing rate and opening resistance.

12.17.3.1 Overhead Door Closers

Overhead door closers are the most common, and they're widely used throughout commercial properties. For example, interior doors within offices, like conference doors, are typically affixed with a door closer that automatically closes the door. Additionally, commercial front doors are also installed with a closer unit, and overhead units are a popular choice.

There are three common types of overhead door closers including: -

1. Regular Arm

The regular arm, or standard arm, closer is a pull-side application, meaning it is located on the exterior of the door. In these applications, there are two arms, one attached to the frame and another to a spring-loaded box on the pull-side of the door. The arms, when closed, project out perpendicularly from the door, which is less attractive than other applications. This is the most power-efficient option available.

2. Top Jamb

Top jamb door closers, like regular arm closers, have arms that project out from the door perpendicularly. Yet, the biggest difference is that the spring-loaded box is mounted on the face of the doorframe. These are often used for aluminum or glass storefront doors, because these doors generally have narrow top rails. Like regular arm closers, top jamb closers are fairly power efficient.

3. Parallel Arm

With a parallel arm application, there are two arms that sit on top of the door when it is closed. They are attached to the door via a spring-loaded box, which sits at the top of the push-side of the door and powers the closing action. Parallel arm door closers are one of the most common applications, particularly in commercial properties and schools, because they reduce the risk of vandalism to the arm and they are more attractive than other overhead options. Due to the arm geometry, these are less power efficient than regular arm and top jamb closers.

12.17.4 Other Types of Door Closers

Although overhead closers are the most common, there are other types that aren't mounted at the top of the door. Concealed closers, for example, are hidden within the jamb, offering a more appealing look. Similarly, floor closers are concealed within the floor and they aren't visible when the door is opened. Examples include: -

Concealed: Concealed closers are fitted into recesses in the door and frame. Thus, they aren't visible when the door is closed. They are available as hydraulic or spring-loaded versions, and they are typically used for interior doors that are fairly light.

Surface-mounted: These types of door closers are fitted to the door frame, with a bar along the back of the door. Typically, these are fairly small in size, and they can be used to match the color of the door. They are a cost-effective option for automatically closing doors.

Floor-Spring: Floor-spring closers are typically used on glass storefront doors. They are mounted in the floor, and are concealed. A bar within the closer is fitted into the underside of the door, which controls the closing action. These provide one of the most appealing looks, and they are often used for upscale commercial properties. Floor-spring closers typically have an open setting, so that they can be left open. Over-head spring closers are also available.

Installation and Adjustment: Installation and adjustment of the door closer must be done as per instructions of Engineer-in-Charge or as per manufacturer technical guide.

12.18 Door Lock System

External door locks shall be mortise locks complying with BS 12209, category A with the dimensions of 80mm case and 57mm backset. The reversible latch bolt operated by lever handles shall have a strong return spring. The latch bolt shall project minimum 12mm. The latch bolt spring tension shall be strong enough to overcome the frictional forces of the lever handle. The lever handle shall have an independent spring mechanism and a properly designed stopper to eliminate transferring of forces to the latch bolt when the lever is depressed. Dead bolt shall be reinforced with two hardened steel inserts or stainless steel and shall have a minimum projection of 14mm. The dead bolt shall be cylinder operated which can be opened by a key from either side of the door. Internal door locks to all doors except WCs and bathroom shall be similar to details of the above external locks' specifications. However, dead bolt may not be strengthened with hardened steel inserts. Locks for WCs and bathrooms shall be lever type mortise lock complying with BS 12209, category A with dimensions of 80mm case and 57mm backset. Operation mechanism of the reversible latch shall be similar to the above external locks. The dead bolt shall be operated by a turn button or thumb turn. All locks shall be supplied with anodized aluminum lock furniture of an approved color along with suitable matching screws or solid stainless-steel handles (Grade 316) approved finish compatible with other approved ironmongery.

12.18.1 Door Bolts

Door bolts shall be fixed top and bottom to one leaf in double door locations. They shall comprise two solid drawn, brass, aluminum or cast aluminum or stainless steel 150 mm long square profile bolts complete with keepers for head fixing and keepers for threshold fixing. The bolts shall incorporate keepers fixed into a screed to maintain the doors in an open position

12.18.2 Fitting

The Contractor shall deposit in the office of the Engineer-in-Charge one sample of each fitting to be used in the work. Unless otherwise specified, fittings shall be of the number size and type as specified.

12.18.3 Special Door Furniture

Where special ironmongery or door furniture is required, it shall be supplied by the department, or provided by the contractor at an extra cost. The cost of fixing or mounting such special furniture shall, however, be included in the rate.

12.18.4 Screws

Screws of such diameter shall be used as to fill completely the holes and cups in the fittings which they secure, and shall be oiled before being inserted. Unless the head can be counter-sunk flush with the fittings, round headed screws shall be used. Brass fittings of specified type shall be secured with brass screws.

12.18.5 Chocks

Hinged chocks shall invariably be fitted to all doors and windows to keep them open. Chocks shall be of hardwood and swung on 3 inches butt hinges and shall act on a sheet metal protector fixed to the door stile.

12.18.6 Stops

Wooden stops of a size suitable for the leaf concerned shall be fixed to the door or window chowkats to prevent the leaf from damaging the plaster of the jamb when fully opened.

12.18.7 Measurement

Wood work wrought, framed and fixed shall be measured for finished dimension without any allowance for the wastage or for dimensions beyond specified dimension. However, in case of members having mouldings, roundings or rebates and members of circular or varying sections, finished dimensions shall be taken as the sides of the smallest square or rectangle from which such a section can be cut. Length of each member shall be measured over all to the nearest cm so as to include projection for tenons. Width and thickness shall be measured to the nearest mm and the quantity shall be worked out in unit of up to three places of decimal.

12.19 Miscellaneous

Fitting shall be of mild steel brass, aluminium or as specified. Some mild steel fittings may have components of cast iron. These shall be well made, reasonably smooth, and free from sharp edges and corners, flaws and other defects. Screw holes shall be counter sunk to suit the head of specified wood screws. These shall be of the following types according to the material used.

Mild Steel Fittings: These shall be bright finish black stone enameled or copper oxidized (black finish), nickel chromium plated or as specified.

Brass Fittings: These shall be finished bright satin finish or nickel chromium plated or copper oxidized or as specified.

Aluminium Fittings: These shall be anodized to natural matt finish or dyed anodic coating as per ASTM B580 - 79.

Screws used for fittings shall be of the same metal, and finish as the fittings. However, chromium plated brass screws or stainless-steel screws shall be used for fixing aluminium fittings. These shall be of the size as indicated in respective figures. Fittings shall be fixed in proper position as shown in the drawings or as directed by the Engineer-in-Charge. These shall be truly vertical or horizontal as the case may be. Screws shall be driven home with screw driver and not hammered in. Recesses shall be cut to the exact size and depth for the counter sinking of hinges.

12.19.1 Butt Hinges

These shall be of the following types according to the material used.

- Mild steel butt hinges (Medium).
- Cast brass butt hinges light/ordinary or heavy.
- Extruded aluminium alloy butt hinges.

12.19.2 Mild Steel (Medium)

These shall be medium type manufactured from M.S. sheet. These shall be well made and shall be free from flaws and defects of all kinds. All hinges shall be cut clean and square and all sharp edges and corners shall be removed. These shall generally conform to ASTM standards.

Hinge Pin: Hinge pin shall be made of mild steel wire. It shall fit inside the knuckles firmly and rivetted head shall be well formed so as not to allow any play or shake, and shall allow easy movement of the hinge, but shall not cause looseness.

Knuckles: The number of knuckles in the hinges of different sizes shall be as per standards. The size of knuckles shall be straight and at right angle to the flap. The movement of the hinges shall be free and easy and working shall not have any play or shake.

Screw Holes: The screw holes shall be clean and counter sunk. These shall be suitable for counter sunk head wood screws and of the specified size for different types, and sizes of hinges. The size of the holes shall be such that when it is counter sunk it shall be able to accommodate the full depth of counter sunk head of the wood screws.

12.19.3 Cast Brass

These shall be light/ordinary or heavy as specified. These shall be well made and shall be free from flaws and defects of all kinds. These shall be finished bright or chromium plated or oxidised or as specified.

Hinge Pin: Hinge pin shall be made of brass or of stainless steel. The hinge pins shall be firmly rivetted and shall be properly finished. The movement of the hinge pin shall be free, easy and square and shall not have any play or shake.

Knuckles: The number of knuckles in each hinge shall not be less than five. The number of knuckles in case of sizes less than 40 mm shall be three. The sides of the knuckles shall be straight and at right angle to the flap. The movement of the hinge pin shall be free and easy and working shall not have any play or shake.

Screw Holes: The screw holes shall be clean and counter sunk and of the specified size for different types and size of hinges. The size of the holes shall be such that when it is counter sunk it shall be able to accommodate the full depth of counter sunk head of wood screw specified.

12.19.4 Extruded Aluminium Alloy

These shall be manufactured from extruded sections. These shall be well made and free from flaws and defects of all kinds.

Hinge Pin: Hinge pin shall be made of mild steel (galvanized or aluminium alloy). The aluminium alloy hinge pin shall be anodized. The hinge pin shall be finally rivetted and shall be properly finished. The movement of hinges shall be free easy and square and shall not have any play or shake.

Knuckles: Number of knuckles in each hinge pin shall not be less than 5. The number of knuckles in case of sizes less than 40 mm be straight and at right angle to the flap. The movement of the hinge pin shall be free and easy and working shall not have any play or shake.

Screw Holes: The screw holes shall be suitable for counter sunk head wood screws, and of specified sizes for different type of hinges. The size of the holes shall be such that when it is counter sunk it shall be able to accommodate the full depth of counter sunk head of wood screw specified.

12.19.5 Parliament Hinges

These shall be of mild steel cast brass or as specified. The size of parliament hinges shall be taken as the width between open flanges. Mild steel parliament hinges shall be copper oxidized (thick finish) or as specified. The brass parliament hinges shall be finished bright, chromium plated or oxidized or as specified.

The hinge pin shall be made of mild steel in the case of brass hinges. The hinge pin shall be mild steel (galvanized) in the case of aluminium alloy hinges. The hinge pin shall be firmly rivetted and shall be properly finished. The movement of the hinges shall be free, easy and square, and shall not have any play or shake.

All screw holes shall be clean and counter sunk to suit the counter sunk head of wood screws specified.

12.19.6 Spring Hinges (Single or Double Acting)

These shall be single acting when the shutter is to open on one side only or double acting when the shutter opens on both sides. These shall be made of M.S. or brass as specified.

Hinges shall work smoothly and shall hold the door shutter truly vertical in closed position. Each double-acting spring hinge shall withstand the following tests which shall be carried out after fixing it to a swing door in the normal manner.

- When the door is pushed through 90° and released 2000 times on each side in quick succession the hinge shall show no sign of damage or any appreciable deterioration of the components during or on completion of the test.
- The door shall require a force of 2.0 ± 0.5 kg for 100 mm hinges and 3.0 ± 0.5 kg for 125 mm and 150 mm hinges at a distance of 45 cm from the hinge pin to move the door through 90°. The size of spring hinge shall be taken as the length of the plate.

These shall be of the following type: -

Mild Steel: The cylindrical casing shall be made either from M.S. sheet of 1.60 mm thickness, lap jointed and brazed, welded and rivetted, or from solid drawn tube of thickness not less than 1.60 mm; or from mild sheet of 1.60 mm thickness pressed to form the two casing and the distance piece. It shall be stove enamelled black or copper oxidized or as specified.

Cast Brass: The cylindrical casing shall be made either from brass sheet of 1.60 mm thickness, lap jointed and brazed, or from solid drawn brass tube of not less than 1.60 mm thickness. It shall be satin, bright nickel plated or copper oxidized or as specified.

12.19.7 Continuous Piano Hinges

These shall be made from mild steel or aluminium alloy sheet, these shall generally conform to IS 3818. All screw holes shall be clean and counter sunk. Piano hinges shall be fixed in the entire length of the cupboard shutters. Its size will be the width of the two flaps when open.

M.S. Piano Hinges: These shall be made from 1 mm or 0.80 mm thick M.S. sheets and shall be protected with anti-corrosive treatment, such as bright polished, chromium plated or oxidised finish.

Hinge pin shall be of galvanized mild steel. It shall fit in the knuckle firmly so as not to allow any play or shake and shall allow easy movement of hinge but shall not cause looseness. The sides of the knuckles shall be straight and at right angles to the flap. The movement of the hinge shall be free and easy and working shall not have any play and shake.

Aluminium Piano Hinges: These shall be made of aluminium alloy sheet and shall be anodized. as per ASTM B580 - 79.

The hinge pin shall fit in the knuckle firmly so as not to allow any play or shake and shall allow easy movement of hinge but shall not cause looseness. The sides of the knuckles shall be

straight and at right angles to the flap. The movement of the hinge shall be free and easy, and working shall not have any play and shake.

12.19.8 Tee Hinges

These shall be made from M.S. sheets and shall be either bright finished or stove enamelled black or as specified. These shall generally conform to IS 206 (Tee hinges shall be well made, free from burrs, flaws, and defects of any kind. The movement shall be square, and the working shall be free and easy without any play or shake. The hole for the hinge shall be central to the bore and shall be square. The hinge pin shall be firm and rivetted over, so that the heads are well formed. All screw holes shall be clear and counter sunk and shall be suitable for the counter sunk head of wood screws.

12.19.9 Sliding Door Bolts

These shall be of mild steel, cast brass, aluminium or as specified, and shall be capable of smooth sliding action.

M.S. Sliding Door Bolts: These shall be made of M.S. sheets and M.S. rods. M.S. sliding door bolts shall be copper oxidized (black finish) or as specified.

Cast Brass Sliding Door Bolts: These shall be made from rolled brass and shall generally conform to BS Standards. The hasp shall be of cast brass and secured to the bolt. Alternatively, the hasp and the bolt may be cast in one piece. The fixing and staple bolts shall be cast with 6 mm studs. Bolts shall be finished to shape and have threaded ends and provided with washers and nuts of square or hexagon type. All components shall be finished smooth and polished before assembly. Cast brass sliding bolts shall be finished bright or chromium plated or oxidised or as specified.

Aluminium Sliding Door Bolts: These shall be made of aluminium alloy. Aluminium sliding door bolts shall be anodized. All screw holes shall be counter sunk to suit the counter sunk head of screws of specified sizes. All edges and corners shall be finished smooth. In case of single leaf door, when iron socket plate or a brass or aluminium fixing bolts (or sliding door bolt) cannot be fixed, hole of suitable size shall be drilled in the door frame and an iron or brass plate cut to shape shall be fixed at the face of the hole. The leading dimensions of the sliding door bolts are illustrated.

12.19.10 Tower Bolts

These shall generally conform to IS 204 (Part. I) & IS 204 (Part. II). Tower bolts shall be well made and shall be free from defects. The bolts shall be finished to the correct shape and shall have a smooth action. All tower bolts made with sheet of 1.2 mm thickness and above shall have counter sunk screw holes to suit counter sunk head of wood screws. All sharp edges and corners shall be removed and finished smooth. The height of knob of tower bolt when the door, window etc. is in closed position from the floor level shall be not more than 1.9 metre. Tower bolts shall be of the following types: -

- Aluminium barrel tower bolts with barrel and bolt of extruded sections of aluminium alloy. The knob shall be properly screwed to the bolt and rivetted at the back.

- Brass tower bolts with cast brass barrel and rolled or cast brass bolt. Or Brass tower bolts with barrel of extruded sections of brass and rolled or drawn brass bolt. The knobs of brass tower bolts shall be cast and the bolt fixed with knob, steel spring and ball shall be provided between the bolt and the barrel.
- Mild steel barrel tower bolts with mild steel barrel and mild steel bolt. Or Mild steel tower bolts with mild steel barrel and castiron bolts.

The plates and straps after assembly shall be firmly rivetted or spot welded. The rivet head shall be properly formed and the rivet back shall be flush with the plate. These shall be made in one piece.

Unless otherwise specified bolt shall have finish as given below: -

- Mild steel tower bolts (Types 1 and 2) Bolts bright finished or plated as specified and barrel and socket stove enameled black.
- Brass tower bolts (type 3 to 5) Bolt and barrel polished or plated as specified.
- Aluminium alloy tower bolts (type 6) Bolt and barrel anodized.

The anodic film may be either transparent or dyed as specified. This shall be of mild steel polished bright or copper oxidized batch electrogalvanized or stove enameled. In case of stove enameled locking bolts, the bolt may be finished bright.

12.19.11 Pull Bolt Locks

These shall be of M.S. cast brass or aluminium as specified. M.S. pull bolt locks shall be copper oxidized (black finish) or as specified. Brass pull bolt locks shall be finished bright, chromium plated or oxidized as specified. Aluminium pull bolt locks shall be anodized. The bolt shall be 10 mm in diameter and the fixing plate 3 mm thick. The stop block shall be screwed to the fixing plate by a small ball and spring over which the bolt shall slide. The fixing plate shall have four holes for fixing it to the door leaf, two of which shall be square to receive 6 mm dia. bolts with round heads, the remaining two shall receive machine screwed with lock nuts. The receiving plate shall be of the same width and thickness as the fixing plate and shall have 3 counter sunk holes. Where the bolt slides into wooden members, like the chowkhat, which have a rebate, the receiving plate shall also be correspondingly shaped so as to fit into the rebate. The screws and bolts shall have the same finish as the main bolt. The leading dimensions of pull bolt locks are given in the drawing. The denominating size of the pull bolt locks shall be length of the fixing plate between guides plus the thickness of the guides.

12.19.12 Door Latch

This shall be of mild steel, cast brass, or as specified and shall be capable of smooth sliding action. In case, of mild steel latch, it shall be copper oxidized (black finish) or as specified and in case of brass, it shall be finished bright, chromium plated or oxidized or as specified. The size of door latch shall be taken as the length of the latch.

12.19.13 Indicating Bolt (Vacant/Engaged)

These shall be of cast brass finished bright chromium plated, or oxidized or as specified. The shape and pattern shall be approved by the Engineer-in-Charge.

12.19.14 Mortice Lock and Latch

The size of the mortice lock shall be denoted by the length of the body towards the face and it shall be 65 mm, 75 mm and 100 mm as specified. The measured length shall not vary more than 3 mm from the length specified. The clear depth of the body shall not be more than 15 mm. The fore end shall be firmly fitted to the body suitably by counter sunk head screw. The latch bolt shall be of specified material and of section not less than 12 x 16 mm for all sizes of locks. If made of two-piece construction both parts shall be rivetted. Ordinary lever mechanism with not less than two levers shall be provided. False levers shall not be used. Lever shall be fitted with one spring of phosphor bronze or steel wire.

Keys: Each lock shall be provided with two keys.

12.19.15 Mortice Latch (With Locking Bolt)

These are generally used in doors of bath rooms, WC's and private rooms. Mortice latch shall, in respect of shape, design and mechanism of the latch and its components parts, generally conform to IS 5930. The material used for the different component parts of the latch shall comply with Tables 1 and 2 of IS 5930, unless otherwise specified. The size of the latch shall be denoted by the length of the body towards the face and shall be 65 mm, 75 mm or 100 mm as specified. The depth of the body shall not be more than 15 mm. The latch shall be of size 10 x 18 mm of shape as shown in Fig. 1 of IS 5930. The locking bolt shall be of section not less than 8 x 25 mm for all size of locks. The mechanism of the latch bolt, its spring, striking plate etc. shall be as described in IS 5930.

12.19.16 Mortice Lock and Latch (Rebated)

These are slightly different from mortice lock described in above and are designed for use in double leaved doors.

12.19.17 Mortice Night Latch

This is a mortice lock having a single spring bolt withdrawn from the outside by using the key and from inside by turning the knob and with an arrangement whereby the lock can be prevented from being opened by its key from outside while the night latch is used from inside the room. It shall be cast or sheet brass, cast or sheet aluminium alloy or Mild steel as specified and of best quality of approved make. These shall be bright finished or copper oxidized (black) finish as specified. Nominal size of the latch shall be denoted by the length of the face over the body in milli- metres. These shall have not less than two levers. False (Dummy) levers shall not be allowed.

Keys: Each latch shall be provided with two keys which should work smoothly and without any appreciable friction in the lock.

12.19.18 Cupboard or Wardrobe Lock

The size of the cupboard lock shall be 40, 50, 65 & 75 mm or other described in item of work. This shall be made of cast brass and shall be of the best make of approved quality. These shall be finished bright or chromium plated or oxidized or as specified. The size of the lock

shall be denoted by the length of the face across the body in mm. These locks shall be fitted with four, five or six levers as specified. False (dummy) levers shall not be used.

12.19.19 Kicking Plates

This shall be of brass (finished bright or chromium plated or oxidized) bronze, stainless steel, aluminum or as specified. Aluminum kicking plates shall be anodized. It shall be made from a plate of minimum thickness 3.0 mm & 1.5 mm in case of stainless steel. Shape of the plate shall be as specified. This shall have beveled or straight edges and shall be fixed by means of counter sunk or rounded screws of the same material and finish as that of the plate. The shape and pattern shall be according to the drawings and as approved by the Engineer-in-Charge.

12.19.20 Door Handles (Doors and Windows)

The door handles shall be well made and free from defects. These shall be finished correct to shape and dimensions. All edges and corners shall be removed and finished smooth so as to facilitate easy handling. Cast handle shall be free from casting defects. Where the grip portion of the handle is joined with the base piece by mechanical means, the arrangement shall be such that the assembled handle shall have adequate strength comparable to that of integrally cast type handles. Door handles shall be of the following types according to the material used:

-
Cast or Sheet Aluminium Alloy Handles: These shall be of aluminum of specified size, and of shape and pattern as approved by the Engineer-in-Charge. The size of the handle shall be determined by the inside grip of the handle. Door handles shall be of 100 mm size and window handles of 75 mm size unless, otherwise specified. These shall be fixed with 25 mm long wood screws of designation No. 6. Aluminium handles, shall be anodized. The finish can be bright natural, matt or satin or dyed as specified.

Cast Brass Handles: These shall be of cast brass of specified size and of the shape and pattern as approved by the Engineer-in-Charge. The size of the handle shall be determined by the inside grip of the handle. Door handles shall be of 100 mm size and window handles of 75 mm size, unless otherwise specified. These shall be fixed with 25 mm long wood screws of designation No 6. Brass handles shall be finished bright satin or nickel chromium plated or copper oxidized or as specified.

Mild Steel Handles: These shall be of mild steel sheet, pressed into oval section. The size of the handles will be determined by the inside grip of the handle. Door handles shall be 10 mm size and window handle of 75 mm size unless otherwise specified. These shall be fixed with 25 mm long wood screws of designation No. 6., Iron handles shall be copper oxidized (black finish) or stove enameled black or as specified.

12.19.21 Floor Door Stopper

This shall be made of cast brass of overall size as specified and shall have rubber cushion. The shape and pattern of stopper shall be approved by the Engineer-in-Charge. It shall be of brass finished bright, chromium plated or oxidized or as specified. The size of floor stopper shall be determined by the length of its plate. It shall be well made and shall have four counter sunk holes for fixing the door stoppers to the floor by means of wood screws. The body for housing of the door stopper shall be cast in one piece and it shall be fixed to the cover plate

by means of brass or mild steel screws and cover plate shall be of casting or of sheet metal. The spring shall be fixed firmly to the pin. Tongue which would be pressed while closing or opening of the door shall be connected to the lower part by means of copper pin. On the extreme end a rubber piece shall be attached to absorb shock. All parts of the door stopper shall be of good workmanship and finish, burrs and sharp edges removed. It shall be free from surface and casting defects. Aluminium stopper shall be anodized. All the floor stoppers selected shall be checked for dimensional requirement, material, manufacture and finish. Any of door stopper which fails to satisfy any one or more of these requirements shall be considered as defective door stopper.

12.19.22 Hanging Rubber Door

These shall be of cast brass, finished bright, chromium plated or as specified. Aluminium stopper shall be anodized. The size and pattern of the door stopper shall be approved by the Engineer-in-Charge. The size shall be determined by its length.

12.19.23 Universal Hydraulic Door Closer (Exposed Type)

These shall be made of cast iron/aluminium alloy/zinc alloy and of shape and pattern as approved by the Engineer-in-Charge.

The door closers may be polished or painted and finished with lacquer to desired color. Aluminium alloy door closer shall be anodized. All dents, burrs and sharp edges shall be removed from various components and they shall be pickled, scrubbed and rinsed to remove grease, rust, scale or any other foreign elements. The nominal size of door closers in relation to the weight and the width of the door size to which it is intended to be fitted.

Performance Requirements: After being fitted in its position when the door is opened through 90°, the same should swing back to angle of $20^{\circ} \pm 5^{\circ}$ with nominal speed but thereafter, the speed should get automatically retarded and in case of doors with latches, it should be so regulated that in its final position the door smoothly negotiates with the latch.

12.19.24 Hasp and Staple Safety Type

This shall be made of mild steel, cast brass or aluminum as specified. M.S. Hasp and staples shall be finished black enameled, or copper oxidized (black finish) or as specified. Brass hasp and staples shall be finished bright chromium plated or oxidized or as specified. Aluminium hasp and staples shall be anodized and the anodic coating shall not be less than grade AC 15 of IS 1868.

M.S. hasp and staples shall be manufactured from M.S. sheet and brass hasp and staples by casting and Aluminum hasp and staples shall be made from dye section. The hinge pin which in all cases shall be of mild steel, shall be firm and its rivetted heads well formed. The movement of hasp shall be free, easy and square and shall not have any play or shake. The hasp shall fit, in the staple correctly. The size shall be determined by the length of the bigger of the hasp.

The staple except in the case of cast one, shall be rivetted properly to its plate. The ends of the hinge pin for the safety type hasp shall be rivetted and properly finished. All screw holes shall be clean and counter sunk to suit counter sunk wood screw. All edges and corners shall be rounded.

- ii. Polyurethane thermal break material.
- iii. Raw plugs, brackets, rubber gaskets, sealants, rollers, vetting latches and any other embedded fixture required for fixing the doors, windows, ventilators and louvers.
- iv. Providing and fixing screens, weather stripping, backer rods, locks, push and pull bars, handles and door closures as approved by the engineer.
- v. Cleaning of aluminum after installation.
- vi. Sealing all around both from inside and outside and also of the screw holes with silicon sealant to avoid water leakage.
- vii. Anodized aluminum works.

12.19.28.2 Measurement

Measurement of acceptably completed works of anodized aluminum doors, windows, ventilators and louvers will be made on the basis of net actual area in square feet provided and installed in position if shown in the drawings or as directed by the engineer.

12.19.29 Rates

Payments will be made for acceptable measured quantities of all finished anodized aluminum doors, windows, ventilators, and louvers on the basis of unit rate per square feet quoted in the BOQs and shall constitute full compensation for all the works related to the item.

12.20 Wooden Stairs

12.20.1 General

The wooden stairs shall be constructed where specified according to drawings with deodar or any other approved quality wood complying with the provisions of chapter 8 of material specifications.

12.20.2 Workmanship

The quality of materials and workmanship shall conform with the provision of Clauses 12.1 or as specified. The glazing where specified shall conform with the provisions of 12.12. The stairs shall be firmly anchored at floor and with walls as specified.

12.21 Wooden Roof

The wooden roofs shall be constructed according to Drawings and as specified. The timber and materials shall conform to the provisions of 12.19. The roofing work shall comply with applicable provisions of Chapter 9 – Roofing.

12.22 Sound Proof

- Where specified shutter and frames of the doors, windows shall be affixed with sound proofing material sheets. The sound proofing sheets shall include cork sheet, rubber sheet and namdaas specified.
- The sheets shall be cut precisely for the size of panels and frames on which they are to be affixed. The cut sheets shall be neatly fixed on the surface by means of screws/adhesive specified in 12.19 as approved by Engineer-in-Charge.

12.23 Wall Lining

Specified timber shall be used, and it shall be sawn in the direction of the grains. Sawing shall be truly straight and square. The timber shall be planed smooth and accurate to the full dimensions, rebates, roundings, and mouldings as shown in the drawings made, before assembly. Patching or plugging of, any kind shall not be permitted except as provided.

12.23.1 Measurements

Length and breadth of superficial area of the finished work shall be measured correct to a cm. Area shall be calculated in square meter correct to two places of decimal. No deduction will be made of openings of areas upto 0.40 sqm nor shall extra payment be made either for any extra material or labour involved in forming such openings.

12.23.2 Grounds

Grounds shall be provided where so specified. These shall consist of first class hard wood plugs or the class of wood used for fabricating the frames, of trapezoidal shape having base of 50 × 50 mm and top 35 × 35 mm with depth of 5.0 cm and embedded in the wall with cement mortar 1:3 (1 cement: 3 fine sand) and batten of first class hard wood or as specified of size 50 × 25 mm or as specified, fixed over the plugs with 50 mm long wood screws. The plugs shall be spaced at 45 to 60 centimeters center to center, depending upon the nature of work. The battens shall be painted with priming coat, of approved wood primer before fixing.

12.23.3 Paneling

1. Material

This paneling shall be decorative or non-decorative (Paintable) type as per design and thickness specified by the Engineer-in-Charge, of 2nd class teak wood, or graded wood pre-laminated particle board or as specified in item.

2. Ornamental Work

The ornamental wood work shall be painted on the back with priming coat of approved wood primer before fixing the same to the grounds with screws, which shall be sunk into the wood work and their tops covered with putty. The ornamental work shall be made true and accurate to the dimensions shown in the working drawings. The fixing shall be done true to lines and levels. The planks for wall lining shall be tongued and grooved, unless otherwise specified.

12.24 U-PVC Doors & Window

UPVC doors, panels, frames, windows, louvers, screens shall be complete in all respect including sashes, glazing beads, mullions, panels, hardware, fasteners etc. and procured from reputed manufacturers approved by the Engineer-in-Charge.

- Allowable Tolerance: - ±2 mm.
- All doors and frame components will be inspected, before installation.

- All components, which are abraded, dented, bent, bowed or show any other structural damage or distortion will be rejected, marked and shall be removed from the site. No component will be allowed to be straightened and then incorporated in the work.

12.24.1 Delivery, Storage and Protection

Protect factory finished u-PVC surface with wrapping strippable finish. Do not use adhesive papers or sprayed coatings that bond when exposed to sunlight or weather.

12.24.2 Environmental Requirements

Do not install sealant when ambient temperature is less than 5°C during 48 hours after installation.

12.24.3 Measurements

The outer length of the vertical and horizontal members of UPVC door frame shall be measured in running meters including embedded length in floor corrected up to a cm. Length and width of the shutters shall be measured to the nearest cm in closed position covering the rebates of the frames but excluding the gap between the shutter and the frame. Area is calculated to the nearest 0.01 sqm.

12.25 Kitchen Cabinets/Wardrobes/almirah

All wooden kitchen cabinet works shall be fabricated by approved subcontractor/ manufacturer and shall be of best quality.

12.25.1 Construction requirements

12.25.1.1 Shop Drawings

The contractor shall submit detailed shop drawings of these items as per the requirement of project including all fitting, fixtures and hardware for the proper execution of kitchen cabinet/wardrobes/almirah for the approval of the Engineer before fabrication.

12.25.1.2 Installation

- All the works shall be installed in position by the manufacturer's skilled workmen specialized in the job. Works shall be executed in accordance with approved shop drawings and or as directed by the Engineer. All work shall be thoroughly protected from the damage at all times by suitable methods approved by the Engineer. Adjacent works shall similarly be protected from damage. Any damage or disfigurement shall immediately be made good at contractor's expense.
- Kitchen cabinet work, generally all framing will be in treated Deodar wood with portions' etc., in best quality commercial plywood. All exposed surfaces will be covered by approved laminates. Exposed edges, if any, will be covered by polished Deodar wood lipping. Where approved counter tops for kitchen will be specified thick selected marble on painted M.S. framing.
- Best quality hinges, metallic drawer guides (with bearing) and handles will be used. Samples and shop drawings to be approved by Engineer.

12.25.1.3 Wardrobes

Wardrobes will be made of deodar/partal wood. Internal partitions will be as shown on the drawings. Shutters will have a (deodar wood) louvered front backed by laminated plywood. All louvers and exposed deodar wood edges/faces will be polished. Best quality hinges metallic drawer guiders (with bearing) handles locks catches etc., will be used. Shoe rack (inside wardrobe) will consist of 13 mm dia (hollow) chrome plated M.S. rods. Samples and shop draw to be approved by the Engineer.

12.25.1.4 Almirah

Almirah will be made of deodar wood with depth of 9" to 12". Internal partitions will be as shown on the drawings. Shutters will have a (deodar wood) louvered front backed by laminated plywood. All louvers and exposed deodar wood edges/faces will be polished. Best quality hinges metallic drawer guiders (with bearing) handles locks catches etc., will be used. Shoe rack (inside wardrobe) will consist of 13 mm dia (hollow) chrome plated M.S. rods. Samples and shop draw to be approved by the Engineer.

12.25.1.5 Measurements

Length and width of the cabinet shall be measured to the nearest cm in closed position covering the rebates of the frames but excluding the gap between the shutter and the frame. Area is calculated to the nearest 0.01 sqm.

12.26 Aluminum Windows and Doors

12.26.1 Description

The work covered under this section comprises of the following: -

- Providing & fixing in position aluminum doors and windows complete with handles, locks, nylon wheels, vinyl weather strips etc. as shown on the drawings and specified hereunder.
- Providing & fixing glass of specified quality and thickness to windows and door.

12.26.2 General Compliance

12.26.2.1 Design Requirements

All doors, windows, railings, Handrails, etc. to comply with B.S. 4873 or equivalent in respect of materials, work sizes and manufacture. All sectional dimensions shown on drawings are only indicative. The contractor shall be responsible to determine the adequacy of these with respect to actual structural and performance requirements. All extrusions shall be of adequate strength, not only to meet the structural performance, but also to minimize the risk of distortion in the finished surfaces.

12.26.2.2 Work Sizes

All dimensions given on drawing are between structural opening and/or between finished surface and allowances shall be made of variation due to constructional tolerances. The contractor shall be responsible to measure actual final dimensions from the Site before fabrication of doors, windows and other assemblies/units.

12.26.2.3 Weather Tightness

Weather tightness and operations shall suit the weather conditions prevailing in the area of installation. All doors and windows will be fabricated as completely air and water tight units including gaskets for glazing, weather stripping, latches, locks, bolts for fixing etc.

12.26.2.4 Air Tightness

The fixed glazed windows shall be as far as possible 100% air tight under all weather conditions. Air infiltration for opening windows and doors when fully closed shall not exceed 3m/hr/meter length of opening joint at a test pressure of 498 N/M as tested in accordance with BS 4315 Part 1.

12.26.2.5 Acoustic Performance

Windows when installed shall provide an average sound reduction of 28 dB over a frequency range of 100-3150Hz.

12.26.3 Material Requirements

12.26.3.1 Aluminum Sections

All aluminum doors and windows as shown on the drawings shall be fabricated with heavy duty high strength aluminum extruded sections of aluminum alloy 6063-TS. Conforming to BS 1474-1972 and BS 1470-1972 aluminum extrusions to be hard colour anodized in dark bronze with an average anodic film thickness of 25 microns. The anodic treatment should conform to BS 3987:1974. aluminum sections of Alcop Thermec or approved equivalent shall be used.

Aluminum section of following thickness should be adopted in field as per the project requirement & as directed by Engineer in Charge:

1. SWG 14 (1.6 mm), 16 (1.2 mm), 12 (2mm), etc.

12.26.3.2 Hardware

Iron mongery, fitting, handles and locks shall be of bronze, stainless steel and aluminum as shown on the drawings or as stated in the Bill of Quantities.

12.26.3.3 Glass

The solar control float glass if specified shall conform to the latest revised BS 952. "First grade imported tinted bronze float glass shall be used subject to approval. The quality, kind, thickness and size of the glass shall be as shown on the drawings or called for in the Bill of Quantities.

12.26.3.4 Sealants

The external joints between the building openings, window frames etc. shall be formed to details shown on drawing and grooves shall be caulked with mastic sealants. External jointing sealants are to be suitable for the type and exposure of building. Material shall not be of a standard lower than one-part polysulphide rubber sealant conforming to BS 5215 and shall be applied strictly in accordance with the manufacturer's instructions. The colour and quality of sealant shall be subject to approval. Where joints to be sealed are deep the sealant must be supported by suitable polythene backing.

12.26.3.5 Weather Stripping

All opening section must be weather stripped with Neoprene glazing gaskets or similar approved and polypropylene pile weather stripping around doors to ensure adequate weather proofing. Aluminum glazing beads are to snap on type without visible fixing and must be adjustable to allow for varying thickness of glass. No PVC weather stripping is acceptable.

12.26.4 Samples

- The contractor shall submit, for approval, samples of each type of door and window showing the quality of materials, workmanship and finish. The samples of iron mongery, fittings and fixtures shall also be got approved before purchases are made by the contractor.
- The samples of glass for each type of glazing along with specifications of the manufacturer of special quality shall be submitted for approval before firm orders are placed for suppliers.

12.26.5 Construction Requirements

The aluminum doors and windows shall be manufactured by an approved manufacturer in this trade. If required, the contractor shall provide shop drawings based on Architectural drawings for the approval before orders are placed with the manufacturers. The manufacturer shall use the latest and approved method of jointing employed in the manufacture of high class work viz. mechanical jointing, reinforced with concealed welding shall be used in the manufacture of doors and windows. The workmanship of metal doors and windows shall conform to applicable provision of BS 990:1970.

12.26.5.1 Wind Pressure

The Design wind speed to which the various elements of glazing and framing will be subjected to shall be calculated in accordance with BS CP-3 and the following wind loads/speeds are to be taken into account.

- Wind Velocity at 85 MPH.
- Height Less than 30'-16 lbs/sq.ft.
- Height 30' to 50' 18.5 lbs/sq.ft.
- Height 50' to 90' – 21 .18 lbs/sq.ft.
- Height 90' to 120' – 25.00 lbs/sq.ft.

All assemblies must be of appropriate shape, thickness and sections, to enable them to resist the loads produced by repeated imposed wind pressures. The maximum deflection over clear span of any member shall be such that it does not induce cracking in glass panels and render the assembly unsafe. No member shall suffer any permanent deformation. No part of the work shall rattle during use.

12.26.5.2 Fixing

The fixing of doors and windows to concrete openings shall be carried out in an approved method as indicated in the drawings or as directed. Provision of necessary groove or rebate and hold-fasts in the concrete shall be made in the form work and no holing or drilling shall be allowed in the exposed concrete finishes. These shall be erected in position after the building structure is completed and by using proper hold-fasts as shown on drawings or counter sunk bolts and screws as directed in accordance with site requirements.

12.26.5.3 Handling

Care shall be taken in handling metal doors, windows, etc., during transportation and at site. These shall be stored under cover and shall be installed only by skilled mechanics, set plumb, level, in alignment and properly braced to prevent distortion.

12.26.5.4 Protection

- The joint between window and doorframes and the building should be caulked with approved building mastic for total weatherproofing.
- After installation, doors, and windows shall be protected from construction hazards that will interfere with their operation or damage their appearance or finish. They shall be cleaned on inside and outside of all mortar, plaster, paint or other foreign matter to present a neat appearance. Hardware and moving parts shall be lubricated.

12.26.6 Glazing

- The work of fixing glazing to doors, windows shall be carried out with the type and quality of glass specified for each door and window and as indicated in the drawings or as directed.
- The glazing of "Antisun" float glass should be in accordance with the recommendations of BS C.P. 152: 1972 and subsequent amendment.
- The sizes of glass indicated on the drawings are approximate only, and the actual sizes required shall be determined by measuring the frames to receive the glass. All glass shall be factory labelled on each pane and the label shall not be removed until finally approved. Glass will be fixed with best quality mastic compound of approved make suitable for the type of glass or with special bead or moulding as shown on the drawing or as directed. Special rubber lining and weather proof brush joints for sliding surfaces shall be provided where indicated.
- Antisun float glass shall be fixed using flexible compounds, sealants, performed strips or gaskets as per recommendation of the door/window manufacturer. The design shall allow for an edge clearance of at least 3mm (1/8") all around unless any dimension exceeds 1500mm (60") when the clearance shall be at least 5mm (3/16") edge cover shall be adequate to retain the glass in position under the design wind loading. The rebate depth edge clearance plus edge cover shall not be less than 11mm (7/16") for 6mm glass. The width of the rebate platform must accommodate the glass, the front and back compound, and glazing bead. The bead depth should not be less than the rebate depth. Setting block, distance pieces, and location blocks shall be used as appropriate. Glass shall be protected against damage. After inspection, any labels, and paint spots shall be removed and glass shall be washed clean. Damages or broken glass shall be removed and glass shall be washed clean. Damages or broken glass shall be removed and replaced before acceptance at not extra expense. After the installation of 'Anitsun' float glass it shall be cleaned using a soft cloth with water and mild soap or liquid detergent, followed by rinsing with clean water and drying.

12.26.7 Measurement

Payment for doors and windows will be made by measuring clean opening area in brickwork or concrete in square feet/meters.

12.26.8 Rate

Rates for all the items under this Section shall cover the cost of furnishing all the materials labour, scaffoldings and appliances at site and performing all operations in connection with their installation in accordance with instructions. It is particularly mentioned that the rates for fixing doors and windows etc. shall include fixing of all finished hardware iron mongery fittings such as locks, peg stays, handles, push plates, kicking plates, door-closers, glazing, flexible compounds, rubber lining and appliances at site and performing all operations in accordance with the drawings and specifications.

12.28 Hand Rail

Contractor will be responsible to fulfil the requirements of heading 12.1 of these specifications

12.28.1 Material

- Teak wood
- Shesham wood
- Any other material approved by Engineer in Charge

12.28.2 Construction Requirements

12.28.2.1 Dimensions

1. Height

Handrail height, measured vertically from the sloped plane adjoining the tread nosing, or finish surface of ramp slope, shall be not less than 34 inches (864 mm) and not more than 38 inches (965 mm).

2. Continuity.

Handrails for stairways shall be continuous for the full length of the flight, from a point directly above the top riser of the flight to a point directly above the lowest riser of the flight. Handrail ends shall be returned or shall terminate in newel posts or safety terminals. Handrails adjacent to a wall shall have a space of not less than 1 1/2 inches (38 mm) between the wall and the handrails.

3. Grip Size:

Required handrails shall be of one of the following types or provide equivalent graspability:

1. **Type I:** Handrails with a circular cross section shall have an outside diameter of not less than 1 1/4 inches (32 mm) and not greater than 2 inches (51 mm). If the handrail is not circular, it shall have a perimeter dimension of not less than 4 inches (102 mm) and not greater than 6 1/4 inches (160 mm) with a cross section of dimension of not more than 2 1/4 inches (57 mm). Edges shall have a radius of not less than 0.01 inch (0.25 mm).
2. **Type II:** Handrails with a perimeter greater than 6 1/4 inches (160 mm) shall have a graspable finger recess area on both sides of the profile. The finger recess shall begin within a distance of 3/4 inch (19 mm) measured vertically from the tallest portion of the profile and achieve a depth of not less than 5/16 inch (8 mm) within 7/8 inch (22 mm) below the widest portion of the profile. This required depth shall continue for not less than 3/8 inch (10 mm) to a level that is not less than 1 3/4 inches (45 mm) below the tallest portion of the profile. The width of the handrail above the recess shall be not less than 1 1/4 inches (32 mm) and not more than 2 3/4 inches (70 mm). Edges shall have a radius of not less than 0.01 inch (0.25 mm).

12.28.3 Measurement and Payment

Item shall be measured in square feet and payment should be made for finished product in all respect including the labor cost. Any substandard/ wrong work will not be paid and contractor will be responsible to replace the work.

12.29 Trellis

Specified timber shall be used, and it shall be sawn in the direction of the grains. Sawing shall be truly straight and square. The timber shall be planed, smooth and accurate to the full dimensions, rebates, rounding, and moldings as shown in the drawings made, before assembly. Patching or plugging of any kind shall not be permitted except as provided.

Plain Trellis: This shall consist of wooden strips or laths 38 mm x 12 mm section, planed and nailed together at every alternate crossing. The strips shall cross each other at right angle and shall be spaced 38 mm apart, so as to form 38 x 38 mm square opening or as shown in the drawing. These shall be fixed with nails to the frame. To cover the ends of strips, 50 x 12 mm beading shall be fixed to the frame with screws. The finished work with a tolerance of +/-1 mm may be accepted.

Trellis Doors and windows Shutters: Shutter frame shall consist of two styles and top, lock and bottom rails, each of section 75 x 38 mm. The styles and rails shall be properly mortised and tenoned. The tenon shall pass through the styles for at least 3/4th of the width of the style. Shutter frame shall be assembled and passed by the Engineer- in-charge before jointing. The joints shall be pressed and secured by bamboo pins of about 6 mm diameter. To this frame plain trelliswork shall be fixed as shown in the drawing or as directed by the Engineer. The fittings, wooden cleats and blocks shall be provided as specified under fixing doors & windows shutters.

Measurement: Width and height of plain trellis work and trellis shutters shall be measured correct to 10mm. The area shall be calculated in square feet nearest to two places of decimal. In case of shutters, the measurements shall be specified above.

Rate: It includes the cost of materials and labor required in all the operations described above.

12.30 Glass Block Masonry

Glass brick, also known as glass block, is an architectural element made from glass. The appearance of glass blocks can vary in color, size, texture and form. Glass bricks provide visual obscuration while admitting light. The modern glass block was developed from pre-existing prism lighting principles in the early 1900s to provide natural light in manufacturing plants. Today glass blocks are used in walls, skylights, and sidewalk lights.

The texture and color of glass blocks can vary in order to provide a range of transparency. Patterns can be pressed into either the inner void or the outside surface of the glass when it is cooling in order to provide differing effects. Glazes or inserts may also be added in order to create a desired private or decorative effect. Glass brick has an r value between 1.75 and 1.96.

Glass wall blocks are fixed together to form complete walls by several methods – the most common method of construction is to bed the blocks together in a Portland cement-based mortar with reinforcing rods of steel placed within the mortar as recommended by the project architect or block manufacturer.

Other methods of construction include several proprietary systems whereby the mortar is replaced by timber or PVC extrusions.

12.30.1 Measurement

Payment for glass block masonry shall be made in 100 square feet/meters.

12.31 Polypropylene stacking chair

The Polypropylene stacking chair or Polyprop is a chair manufactured in an injection moulding process using polypropylene. It was designed by Robin Day in 1963 for S. Hille & Co.

This is one of the very few chairs that after over 50 years is still in production and has been made in forty countries around the world, for schools, hospitals, airports, canteens, restaurants, arenas, hotels, as well as homes.^[1] It is the best-selling chair in the world.^[2]

The brief from Hille was for a low-cost mass-produced stacking chair, affordable by all and to meet virtually every seating requirement. Over time it became available in a wide variety of colours and with different forms of base and upholstery. These variations have included Series E for children, made in five sizes with lifting holes, and Polo with rows of graduated circular holes making it suitable for outdoor use.

The one-piece seat and back was injection moulded from polypropylene, a lightweight thermoplastic with a high impact resistance. Polypropylene was invented by an Italian scientist, Giulio Natta, in 1954.

12.31.1 Measurement

Payment for polypropylene chairs shall be made in per each.

12.32 Pre-fabricated Building

A prefabricated building, informally a prefab, is a building that is manufactured and constructed using prefabrication. It consists of factory-made components or units that are transported and assembled on-site to form the complete building.

Architects are incorporating modern designs into the prefabricated houses of today. Prefab housing should no longer be compared to a mobile home in terms of appearance, but to that of a complex modernist design. There has also been an increase in the use of "green" materials in the construction of these prefab houses. Consumers can easily select between different environmentally friendly finishes and wall systems. Since these homes are built in parts, it is easy for a home owner to add additional rooms or even solar panels to the roofs. Many prefab houses can be customized to the client's specific location and climate, making prefab homes much more flexible and modern than before.

12.31.1 Measurement

Payment for prefabricated building shall be made in square feet / meter square.

ANNEXURE -1 TABLE FOR SIZES

Lin No.	Particulars of type of doors and windows (a)	Size of chowkats	No. of hold fast (e)	Thickness of leaves	Width of styles rails ledges or braces (h)	Hinges No. and size	Top of master style	Batten of master style or bottom rail	Top of under style	Lock or freize rail	Handles (u)	Hinged chocks	Door stops	Line No.	Remarks.
1	2	3	4	5	6	7	8	9	10	11	12	13	14	15	16
	GLAZED OR PARTLY GLAZED FRAMED DOORS (Paneled or battened).														
1	Double upto 4"x7"	3"x4½"	4	1¾"	3½"	6-4"	1-9"	1-9"	1-9"	6"-p	3-6"	2-4"	2-6"	1	a. Dimensions given are out toout of the chowkat containing the leaves except where marked (a)
2	Double exceeding 4"x7" up 5"x8"	3½"x 4½"	6	2"	4"	6-5"	1-(0)	1-9"	1-(0)	8"-p	3-8"	2-6"	2-6"	2	Where the dimensions of each leaf is given
3	Double exceeding 5"x8"	3½"x5"	6	2"	4½"	6-5"	1-(0)	1-12"	1-(0)	10"-p	3-10"	2-9"	2-12"	3	b.No.chowkat doors

4	Single upto 3"x6 ½ "	3"x4½"	4	1¾"	4"	3-5"	1-9"	1-9"	:	8"-q	2-6"	1-4"	1-6"	4	Will fit into rebate in the walls and lintel.
5	Single upto 3"x6 ½ "	3"x4½"	4	2"	4½"	3-5"	1-(0)	1-9"	:	10"-q	2-6"	1-6"	1-8"	5	c. Dimension given is for a chowkat carrying two sets of leaves.
FRAMED DOORS PANELLED OR BATTENED															
6	Double upto 4"x7"	3"x4½"	4	1¾"	4"	6-4"	2-9"	2-9"	2-9"	:	3-5"	2-4"	2-6"	6	d. Chowkat to be the same as for main door or window.
7	Double exceeding 4"x7" upto 5"x8"	3½"x 4½"	6	2"	4½"	6-5"	2-(0)	2-9"	2-(0)	:	3-8"	2-6"	2-8"	7	e. Number to be increased by 2;
8	Double exceeding 5"x8"	3½"x5"	6	2"	5"	6-6"	2-(0)	2-12"	2-(0)	:	3-10"	2-8"	2-12"	8	If there is no sill.
9	Single upto 3"x6 ½ "	3"x4½"	4	1¾"	4"	3-5"	1-9"	1-9"	:	1-9"	2-6"	1-4"	1-6"	9	f.1½" deodar ledges and braces
10	Single exceeding 3"x6 ½ "	3"x4½"	4	2"	4½"	3-5"	1-(0)	1-9"	:	1-9"	2-6"	1-6"	1-8"	10	And 1 inch battens.
11	Garrage doors :	(b)	-	2½" f	6"	6-18"i	:	:	:	14"-p	(t)	(t)	:	11	g.1 ½ " ledges and braces, 1 inch battens.
LEDGED AND BRACED															

DOORS.															
12	Double upto 4"x7"	5"x4½"	4	2½" g.	4"	6-8"(k)	1-9"	1-9"	1-9"	6"-p.	3-9"	2-4"	2-6"	12	h.(i) Meeting styles may be 3 quarter of the dimensions given
13	Double exceeding 4"x7"	3½"x 4½"	6	2½" g.	:	6-10" (k)	1-12"	1-9"	1-12"	8"-p	3-5"	2-4"	2-6"	13	ii) For doors upto 7",8"and above 8" in height the lockrails should be 6",7"and wide, respectively and the bottom rails 8",9"and 10" wide respectively.
14	Single upto 3"x6 ½ "	3"x4½"	4	2¼"	4"	3-8"(k)	1-9"	1-9"	:	8"-q	2-6"	1-4"	1-6"	14	
15	Single exceeding 3"x6 ½ "	3"x4½"	6	2¼" g.	4½"	3-10" (k)	1-12"	1-9"	:	8"-q	2-6"	1-4"	1-6"	15	
LEDGED DOORS AND COUNTRY DOORS.															
16	Double all sizes:	3½"x 4½"	4	2¼" g.	4"	6-8" (k)	1-Ⓜ	:	:	1-(R)	:	:	:	16	i. Strap hinges hung on 1 inh diameter paintles fixed to hold fasts which

															are embedded in cement concrete blocks let in to the wall.
17	Single all sizes	3½"x 4½"	4	2¼"	4"	3-10" (k)	:	:	:	2-(R)	:	:	:	17	
WIRE GAUZED DOORS.															k. Cross garnet or "T" hinges-dimension given is the length of the strap.
18	Double upto 4"x7"	3"x5" (c)	:	1 ½"	4"	4-5" (l)	1-9"	1-9"	:	:	2-8"	2-4"	:	18	l. Single acting spring hinges.
19	Double exceeding 4"x7"	3½"x 5½" (c)	:	1¾"	4½"	6-5" (l)	1-(0)	1-(0)	:	:	2-8"	2-5"	:	19	m. Two double action spring hinges per leaf; no blanks.
20	Single upto 3"x6 ½"	3"x5" (c)	:	1½"	4"	2-5" (1)	:	:	:	1-4"	1-8"	1-4"	:	20	o. Length to be such that the bolt is 6 feet 3 inch from the floor.
21	Single exceeding 3"x6 ½"	3½"x 5½" (c)	:	1¾"	4½"	3-5" (l)	:	:	:	1-4"	1-8"	1-5"	:	21	p. Black japanned wrought steel safety hasp (strap converging up fixing screws).
SWING DOORS ALL VARIETIES															q. Galvanized iron safety

																door bolt with staple for padlock.
22	upto 3"x6 ½ "(a)	3"x4½"	4	1½"	4"	2-4" (m.)	:	:	:	:	:	:	:	22	r. Good quality galvanized iron or japanned chain and staple.	
23	Size of leaf exceeding 3"x6 ½ "(a)	3"x4½"	4	1½"	4"	2-4" (m.)	:	:	:	:	:	:	:	23	s. Non-twist coloured cord with wooden weight; also brass cleat on wooden shield fixed to the wall	
WINDOWS																
24	Glazed double upto 3"x5"	3"x3½"	4	1½"	2¾"	4-4"	1-(0)	1-4"	1-(0)	:	2-5"	2-4"	2-5"	24	t. Two 24" tower bolts fitted to the bottom of styles and working in eyes fixed to door stops, fixed in the floor.	
25	Glazed double	3"x4"	4	1¾"	2¾"	4-4"	1-(0)	1-6"	1-(0)	:	2-6"	2-4"	2-5"	25	u. Handles to be of best pressed steel, black japanned. Dimensions given are overall	

	exceeding 3"x5" upto 4"x5"														
26	Glazed double exceeding 4"x5"	3"x4½"	4	2"	3"	4-5"	1-(0)	1-9"	1-(0)	:	2-8"	2-5"	2-6"	26	
27	Glazed single upto 2"x5"	3"x3½"	4	1½"	3"	2-4"	1-(0)	1-4"	:	:	1-8"	1-4"	1-5"	27	
28	Glazed single exceeding 2"x5"	3"x4"	4	1¾"	3"	2-5"	1-(0)	1-6"	:	:	1-8"	1-4"	1-5"	28	
29	Fanlights	(d)	2	1½"	2½"x 3"	2-4"	:	2-4"	:	:	1-8"	:	:	29	
30	Clerestory windows	3"x3"	2	1½"	3"	Point	(s)	:	:	:	:	:	:	30	
31	Battened double all sizes	3"x4"	4	2¼" g	3"	2-8" (k)	:	:	:	1-(R)	:	:	:	31	
32	Battened single all size	3"x4"	4	3¼" g	3"	2-8" (k)	:	:	:	1-(R)	:	:	:	32	
33	Wire gauzed upto 2"x5"(a)	3"x4¾" (c)	:	1½"	3"	2-4"	1-(0)	1-4"	:	:	L:	:	:	33	
34	Wire gauzed exceeding 2"x5"(a)	3"x5"	:	1½"	3½"	2-4"	1-(0)	1-4"	:	:	:	:	:	34	
35	Wire gauzed	2"x2½"	:	1½"	2½"	2-4"	:	2-3"	:	:	1-4"	:	:	35	

shutters to C.S. windows																
-----------------------------------	--	--	--	--	--	--	--	--	--	--	--	--	--	--	--	--

ANNEXURE – 2 General Drawings/Cross section of Door & Windows

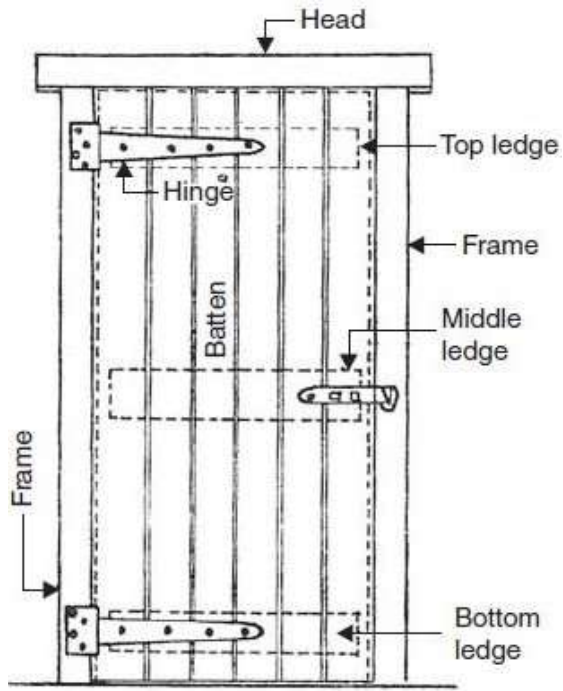

FIGURE 1 LEGED DOOR

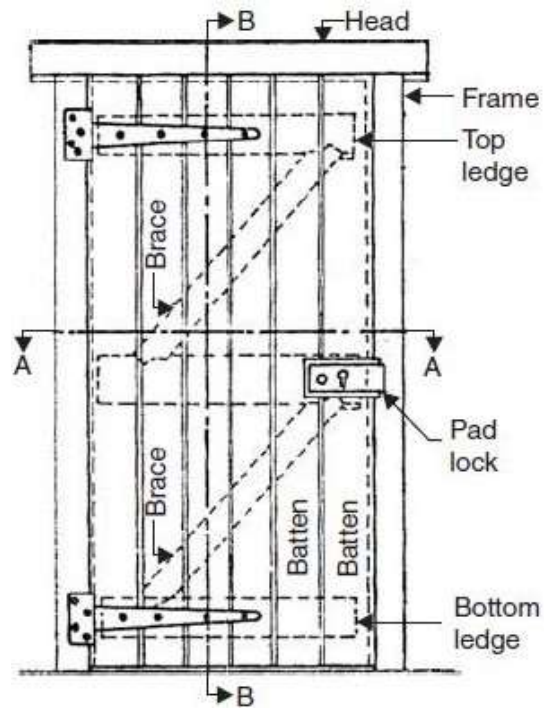
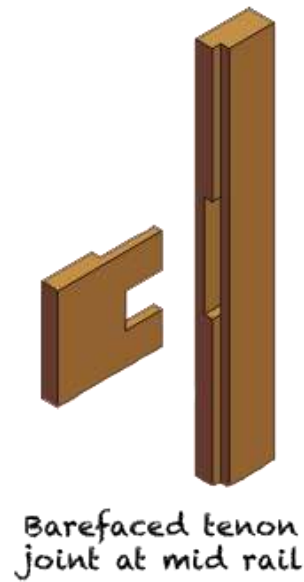
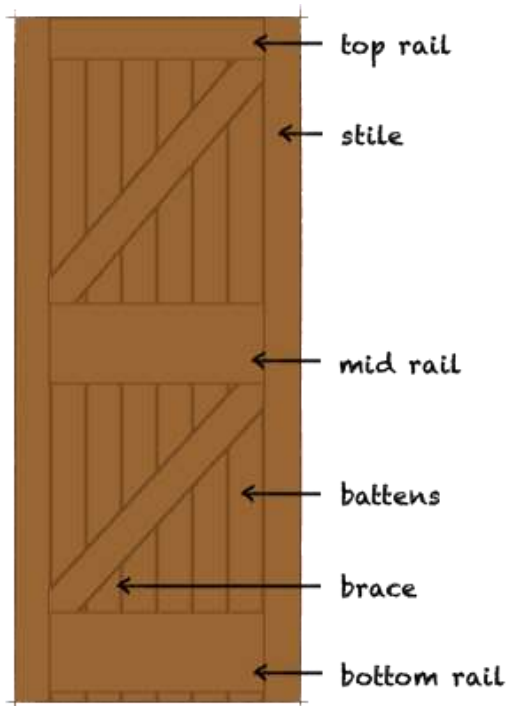
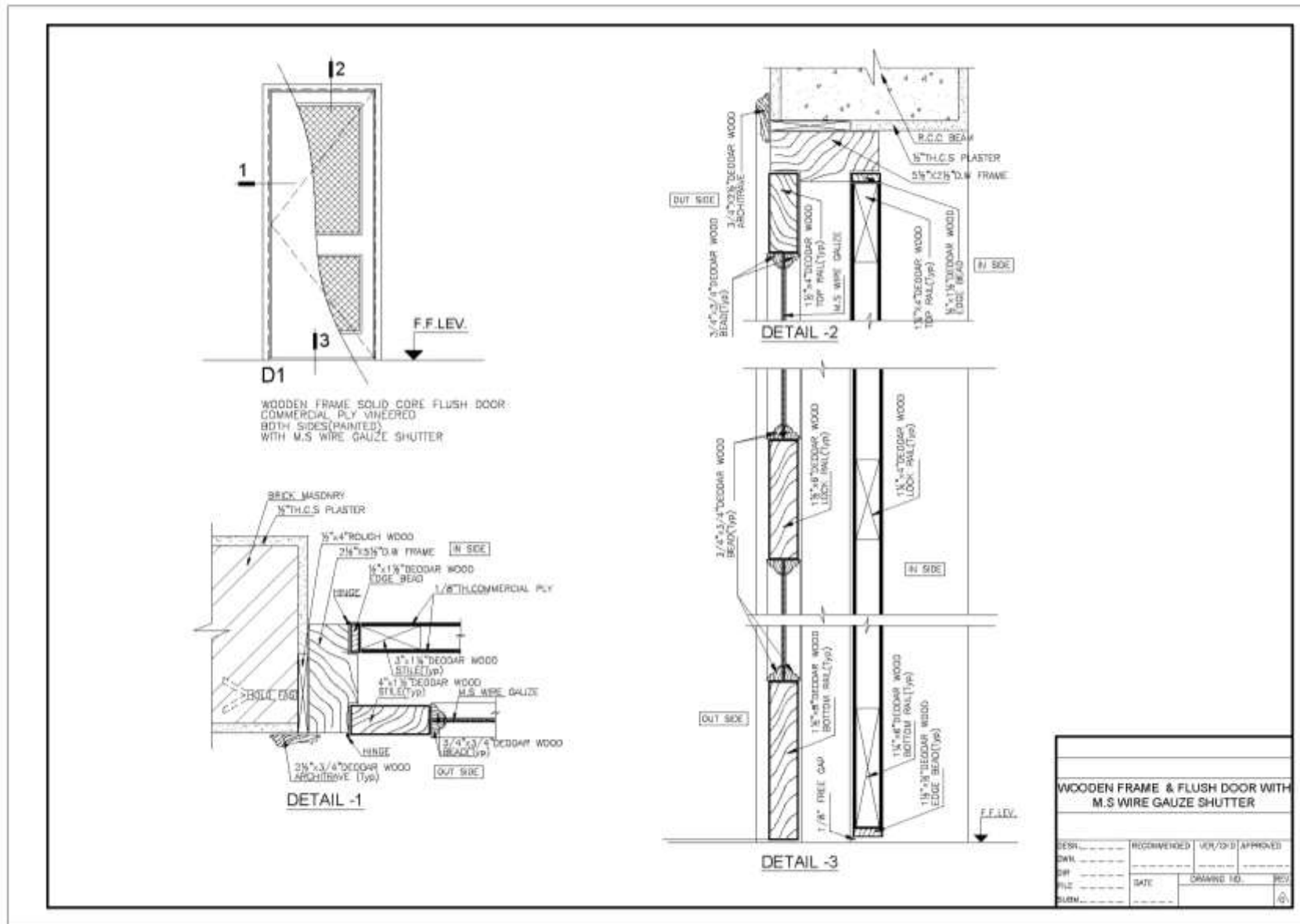
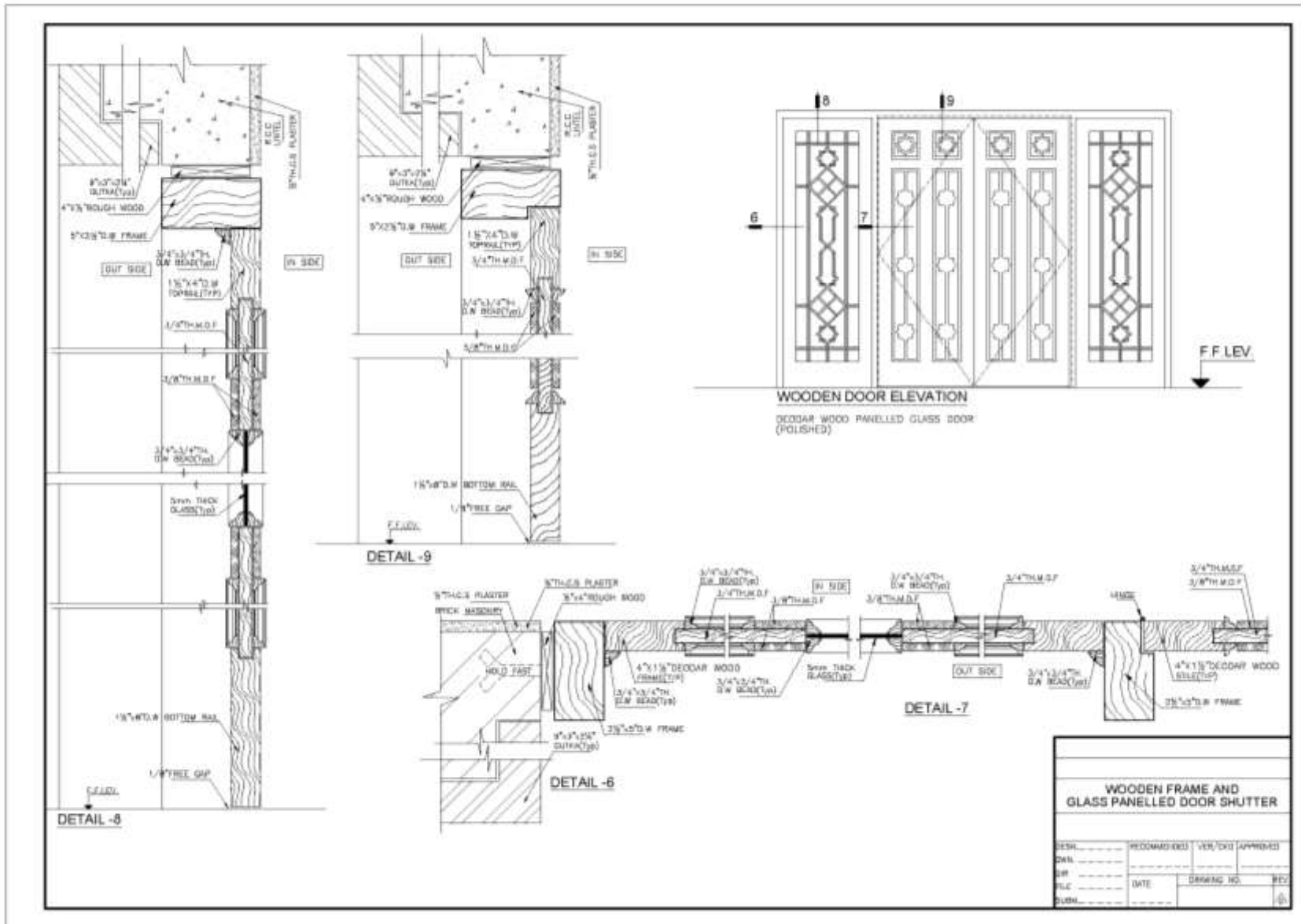
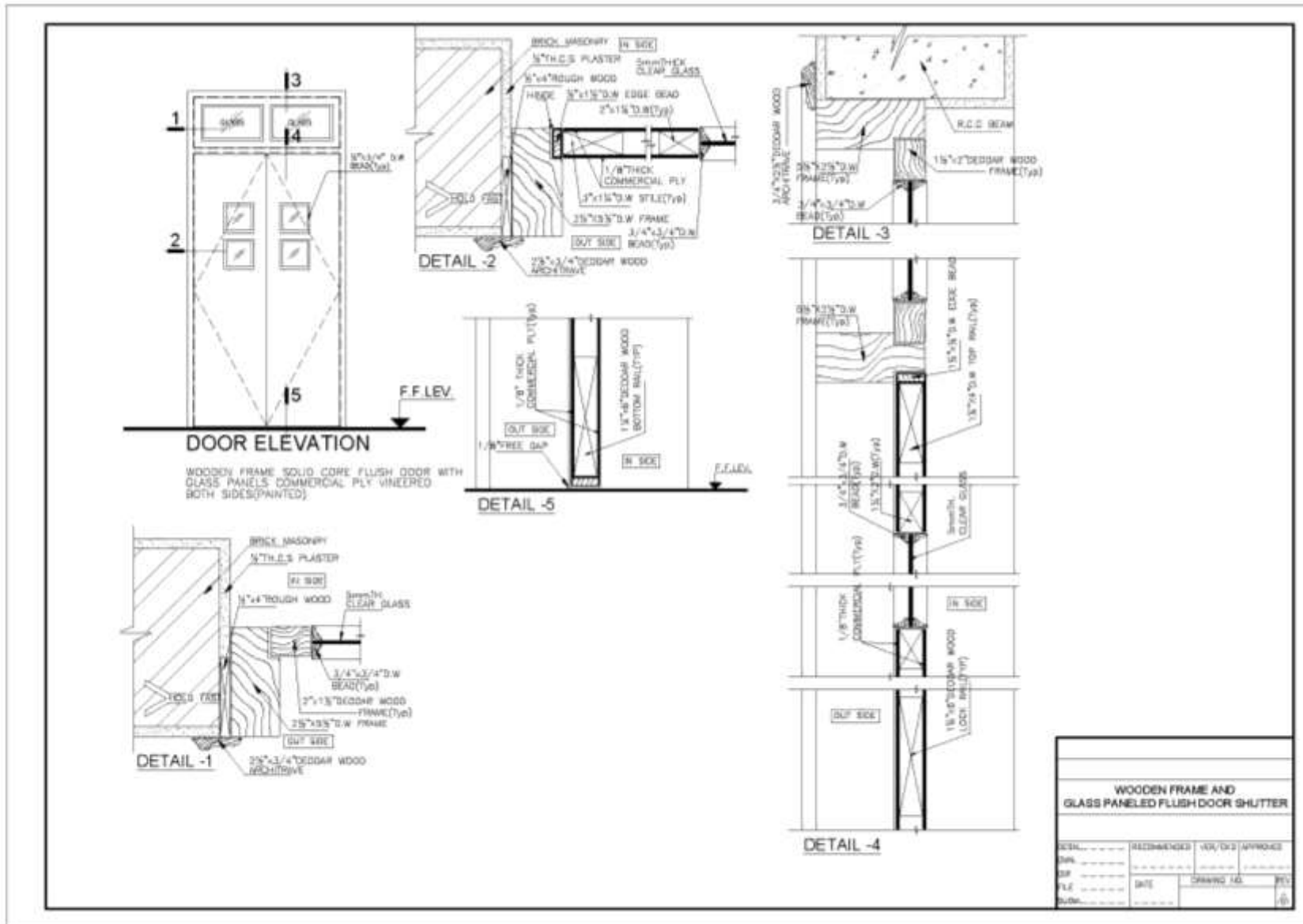

FIGURE 2 LEGED & BRACED DOOR









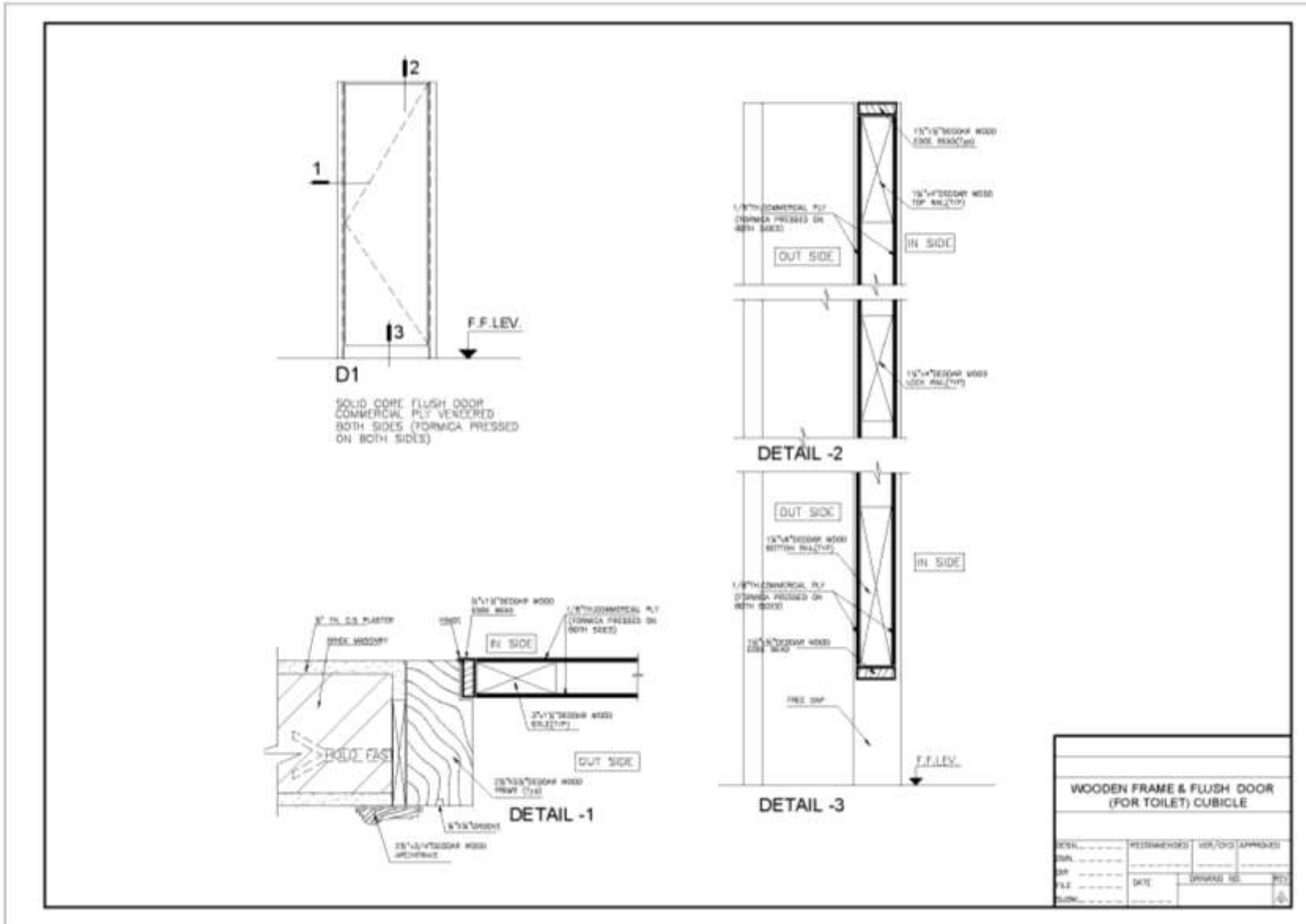

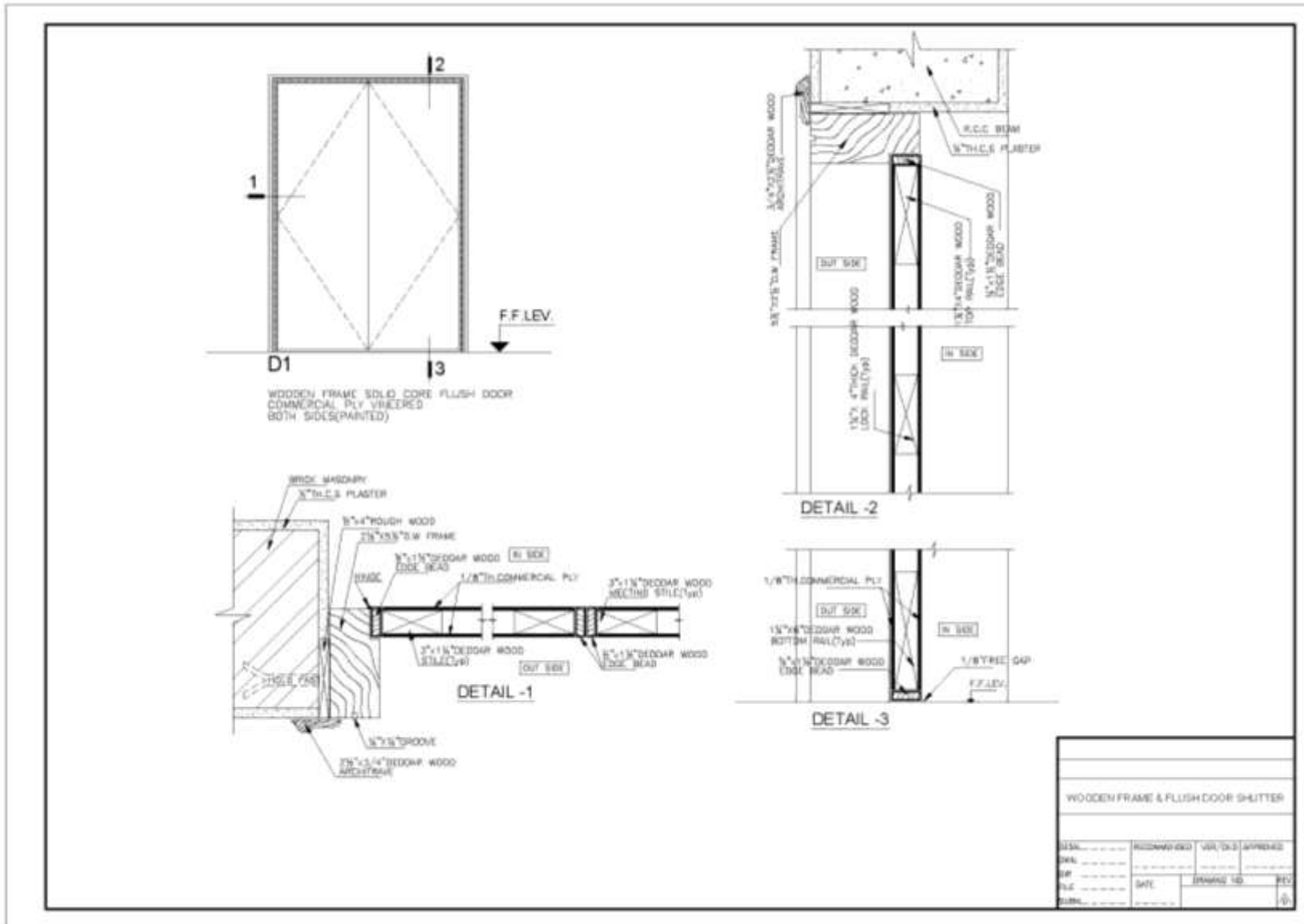

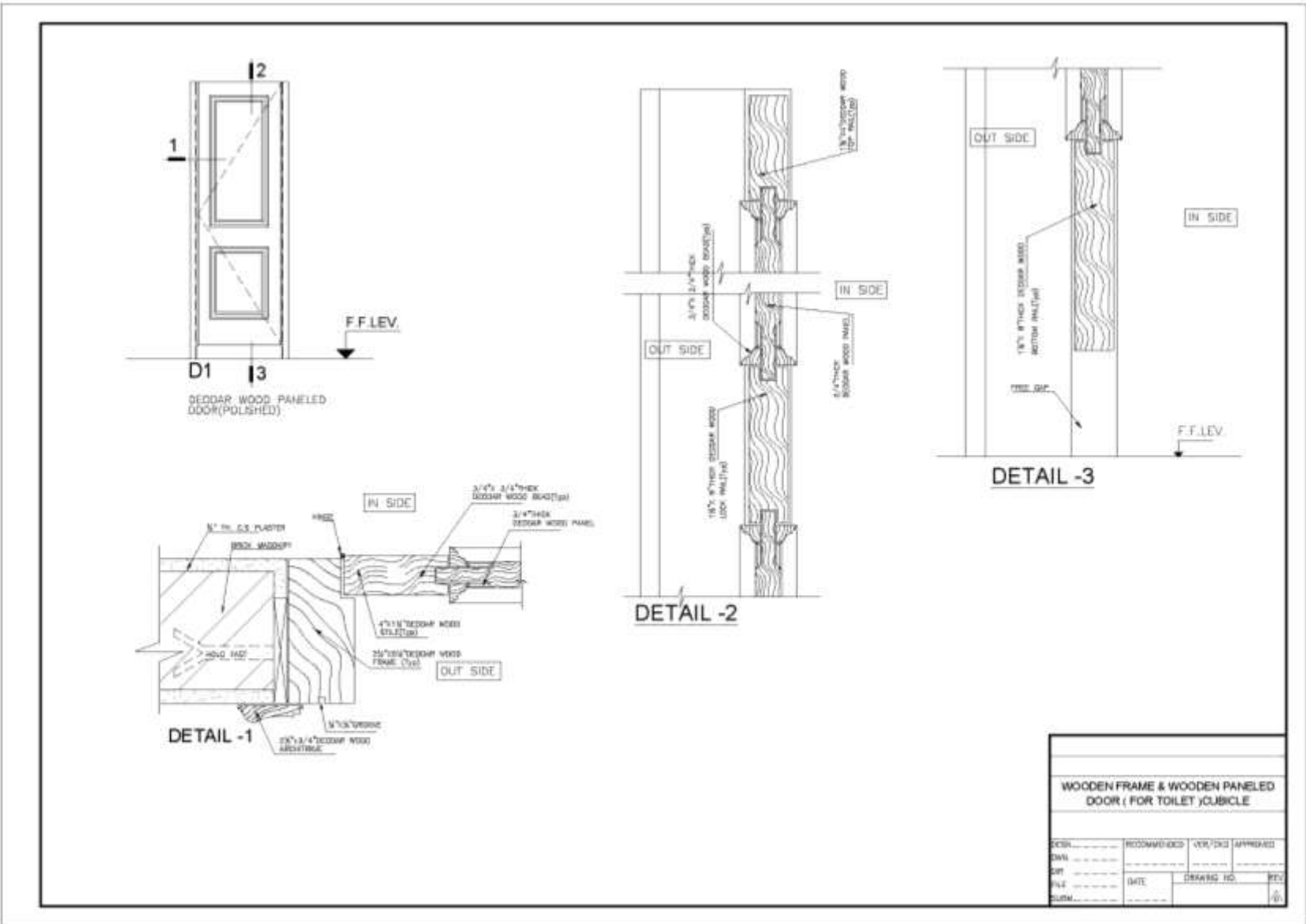

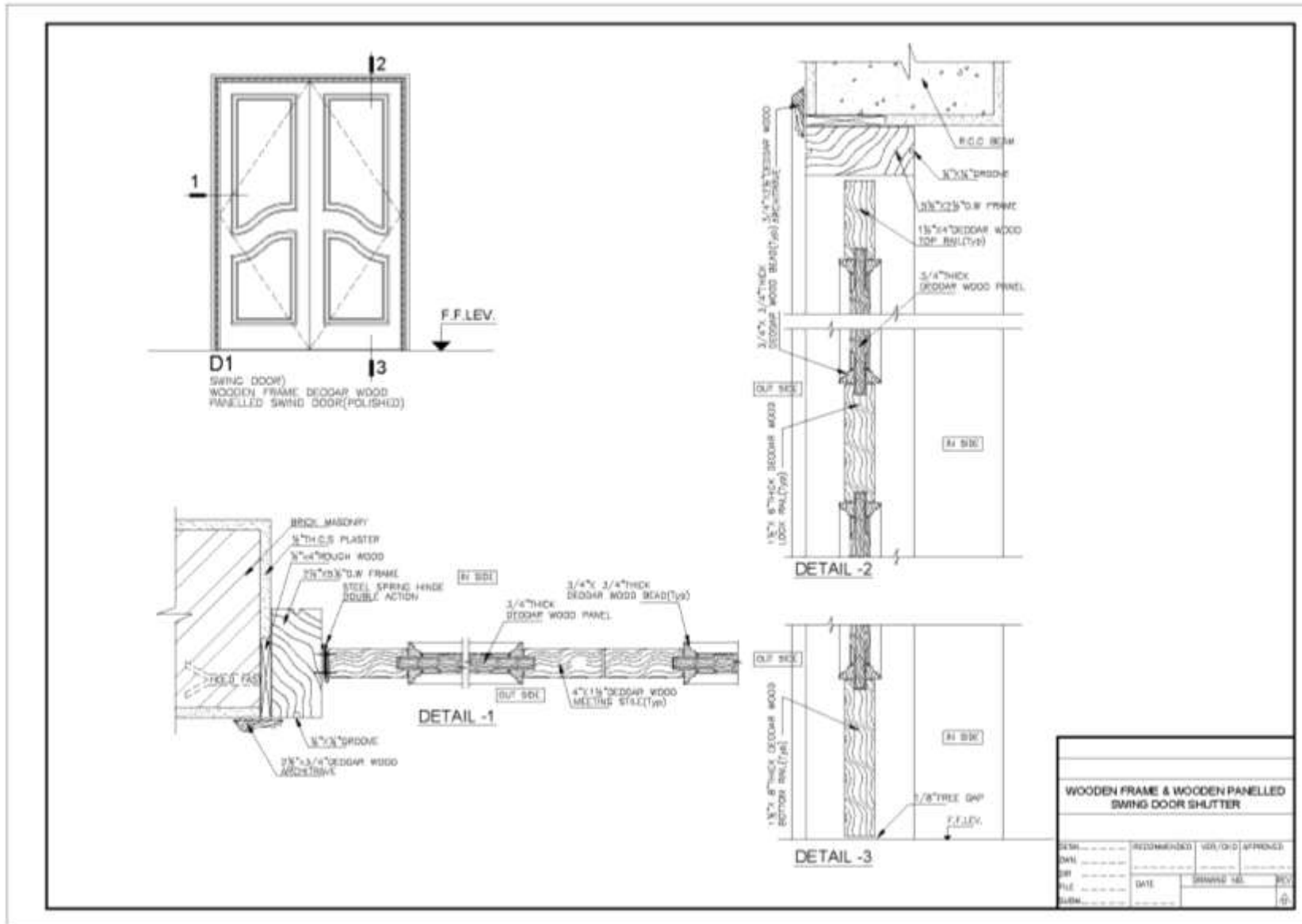

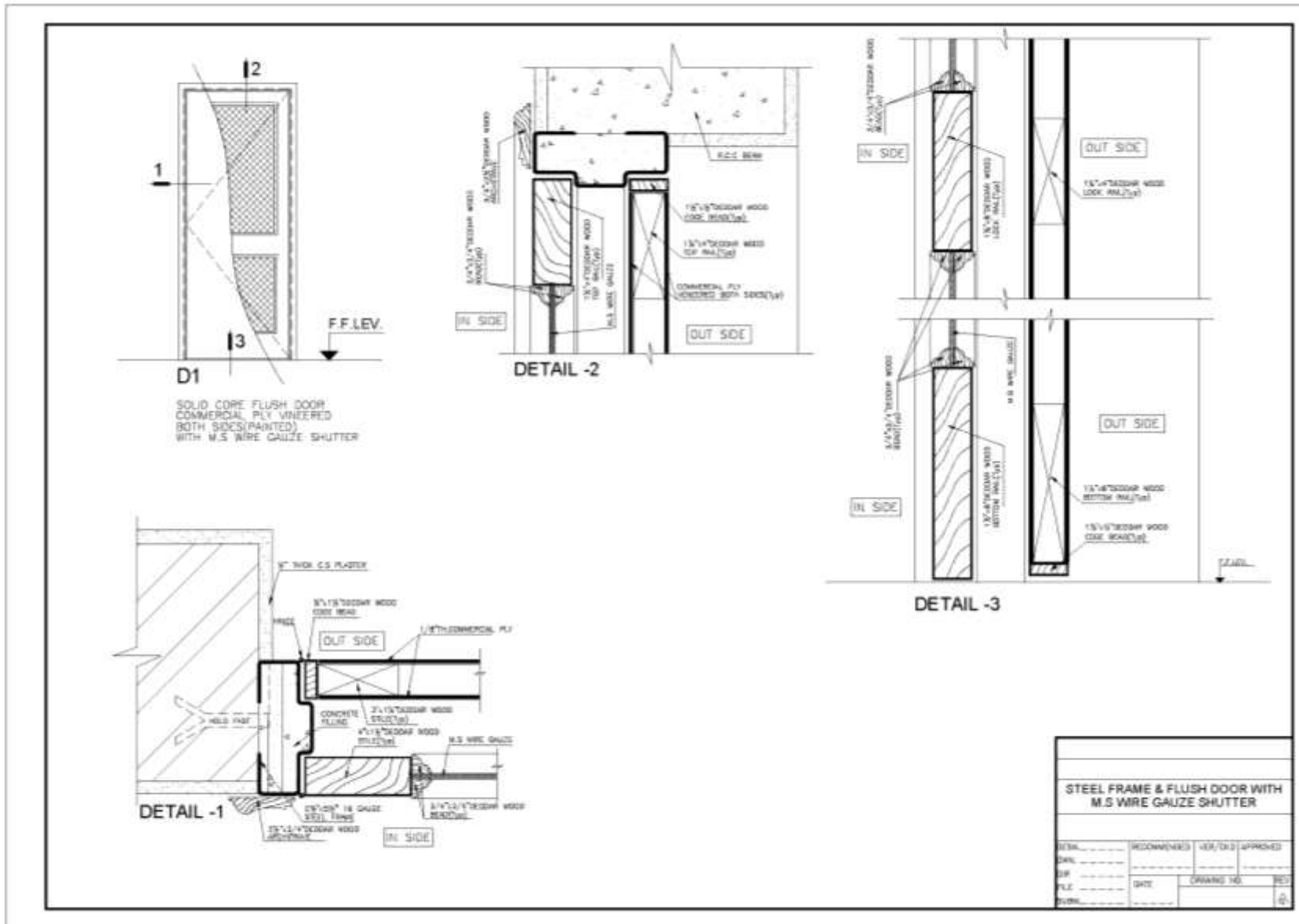

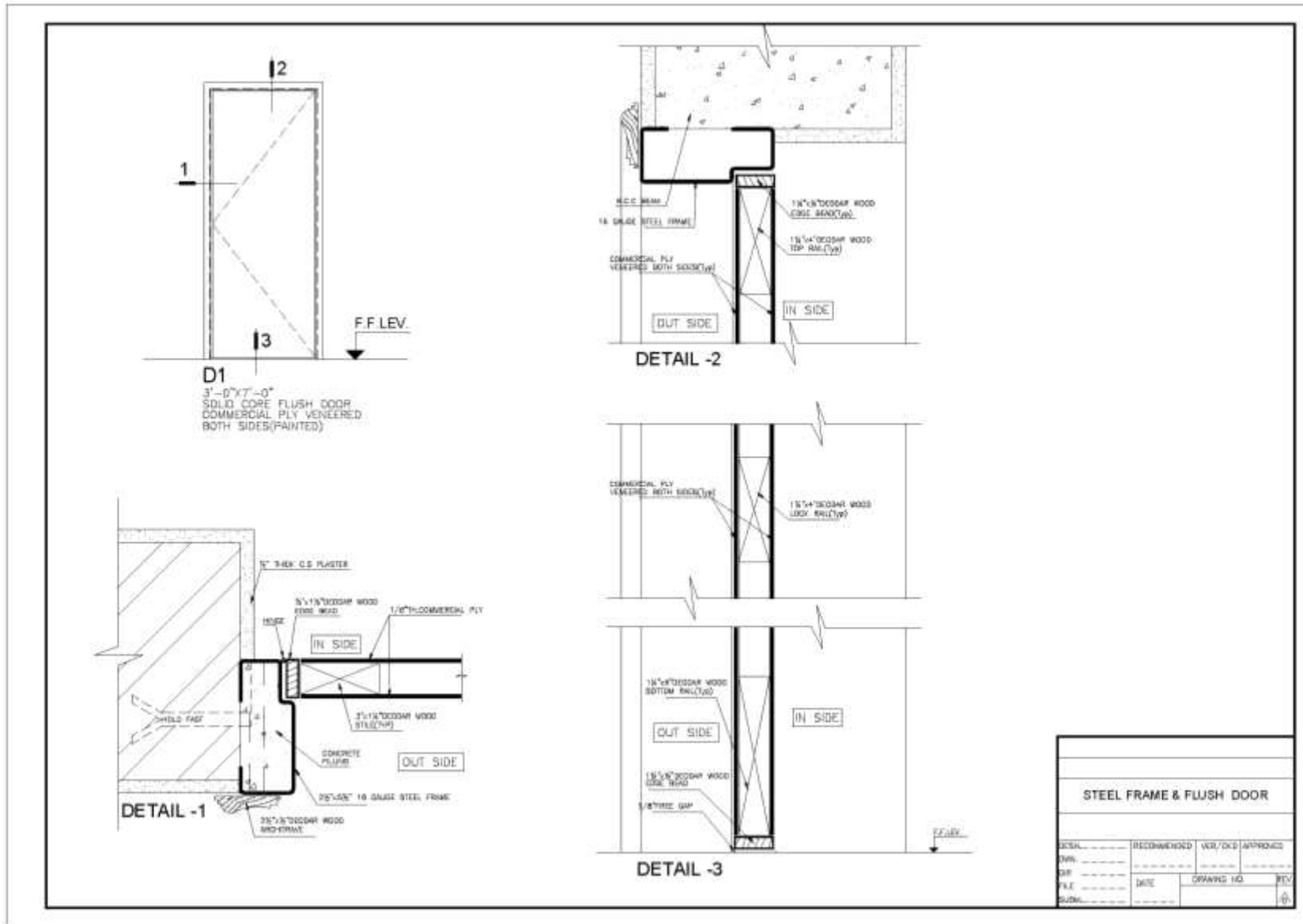

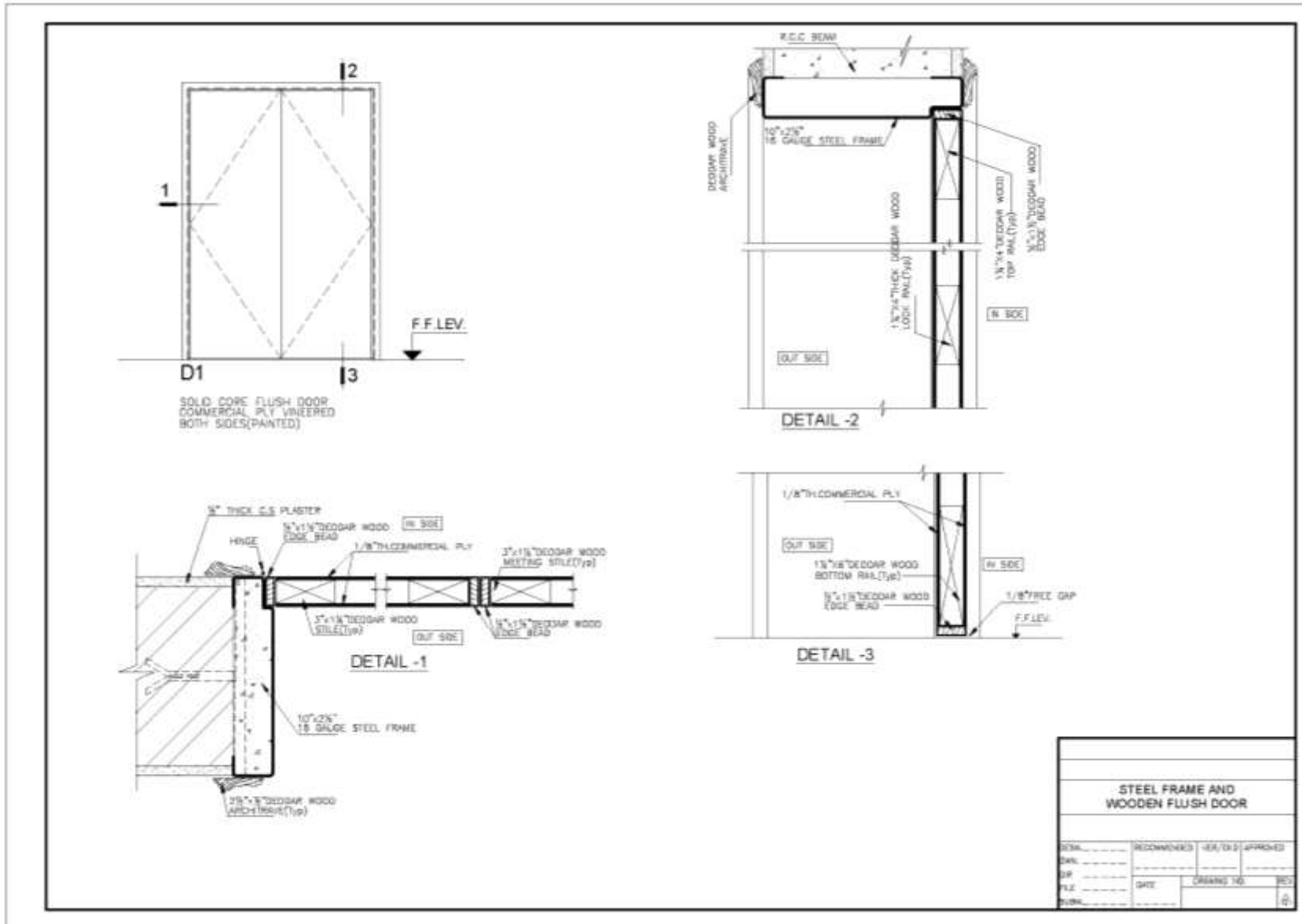

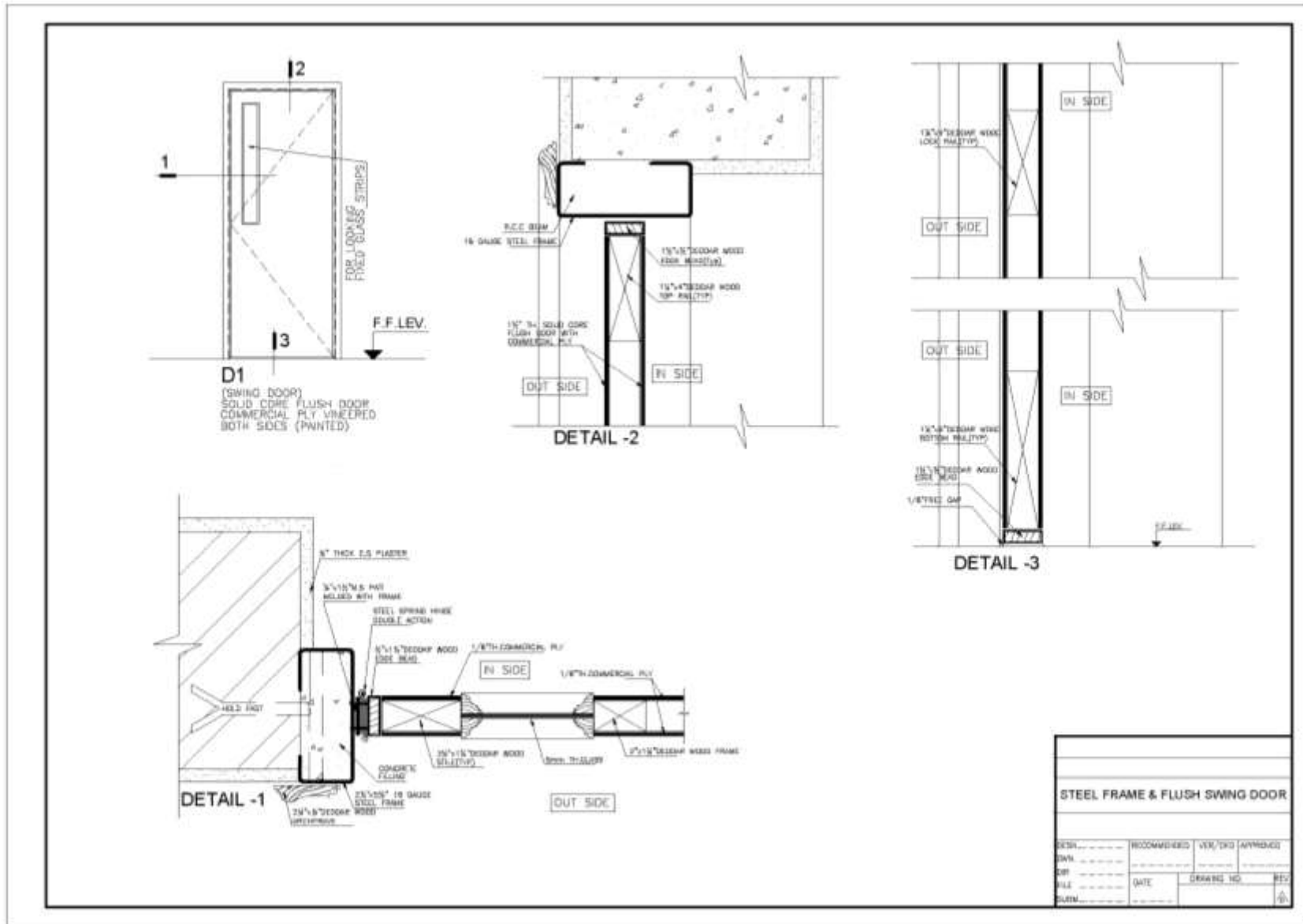

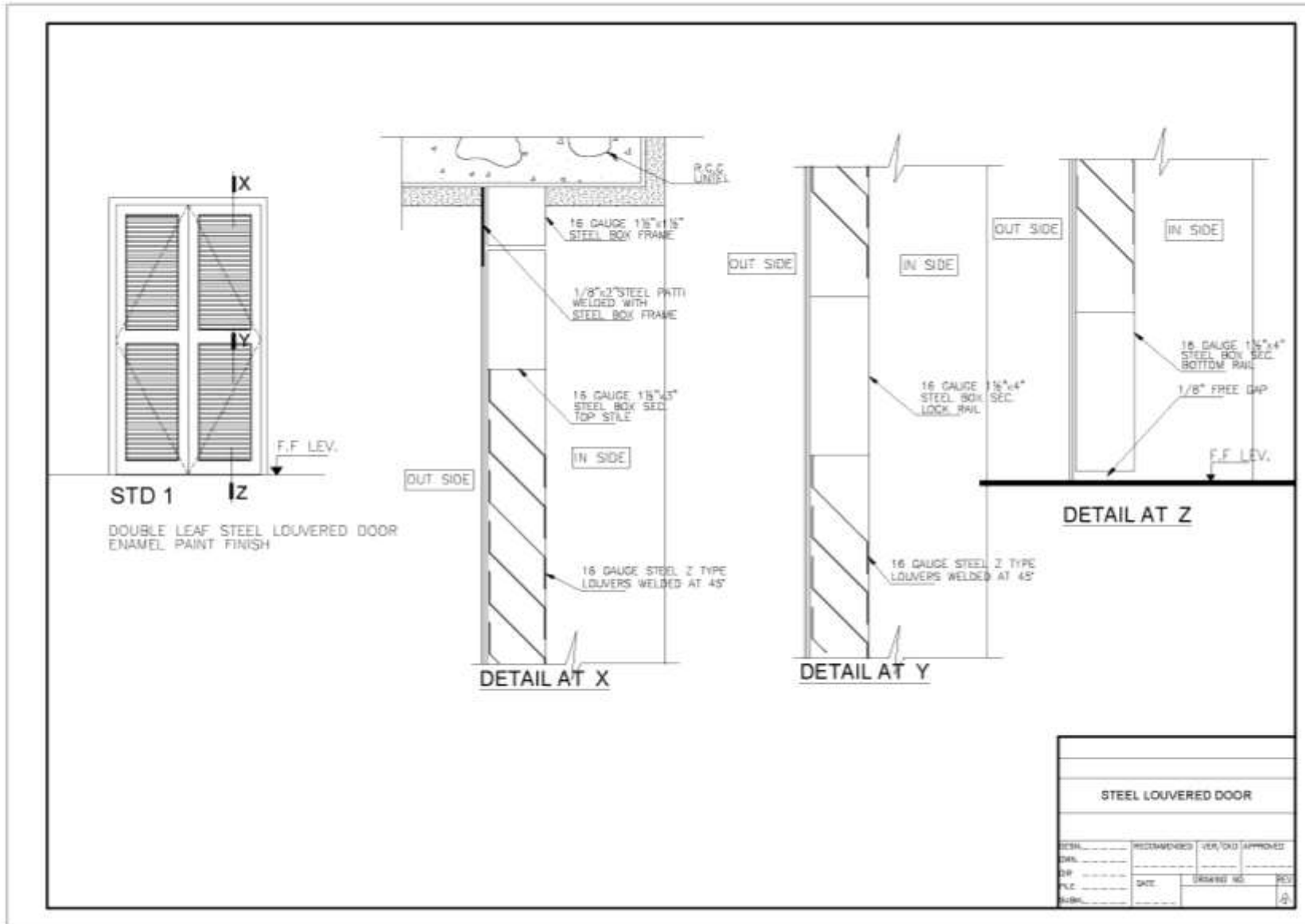

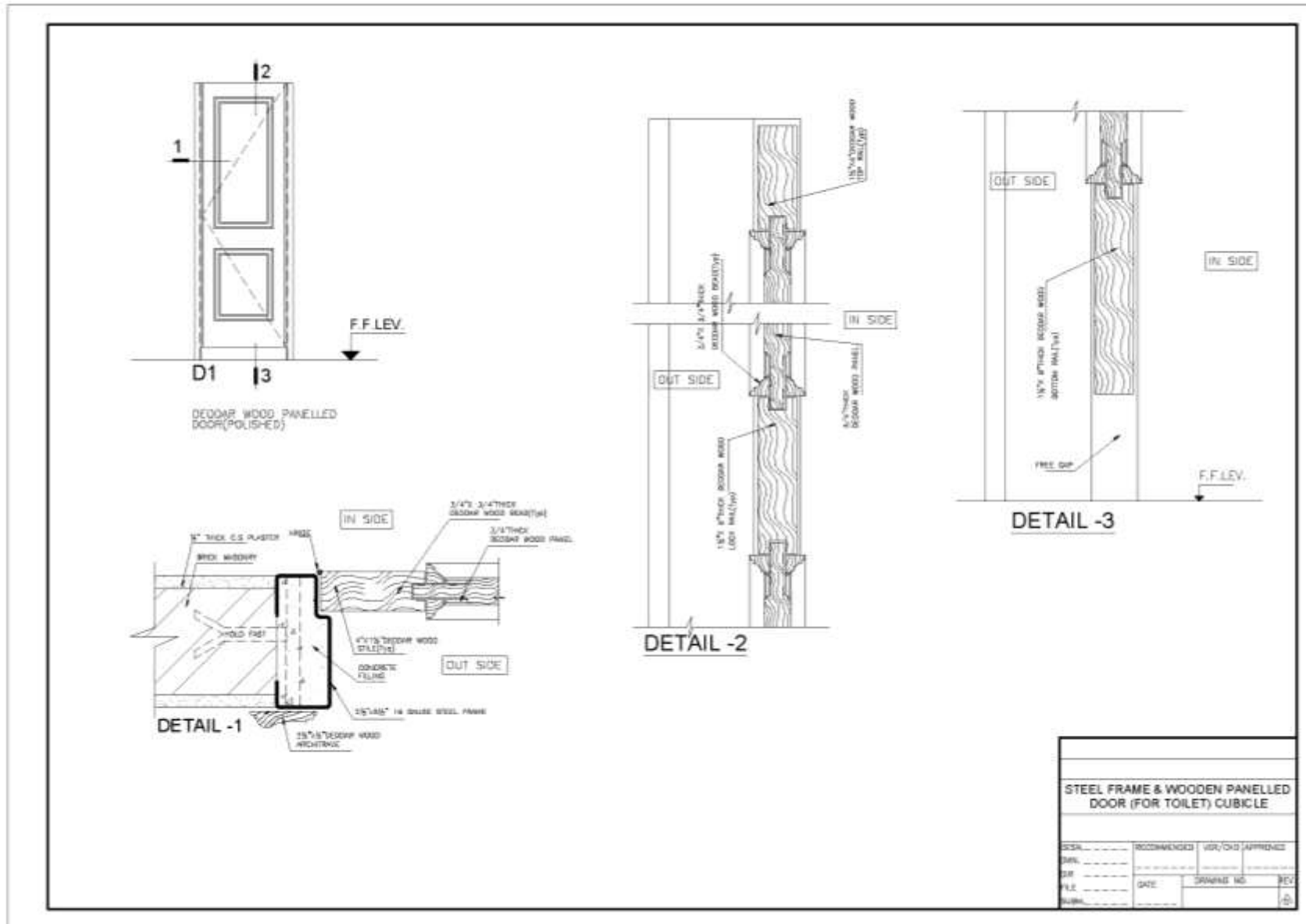

STEEL FRAME & WOODEN PANELLED DOOR (FOR TOILET) CUBICLE			
DESIGNER	RECOMMENDED	VDI/CHK	APPROVED
DRAWN			
DATE		DRAWING NO.	REV.

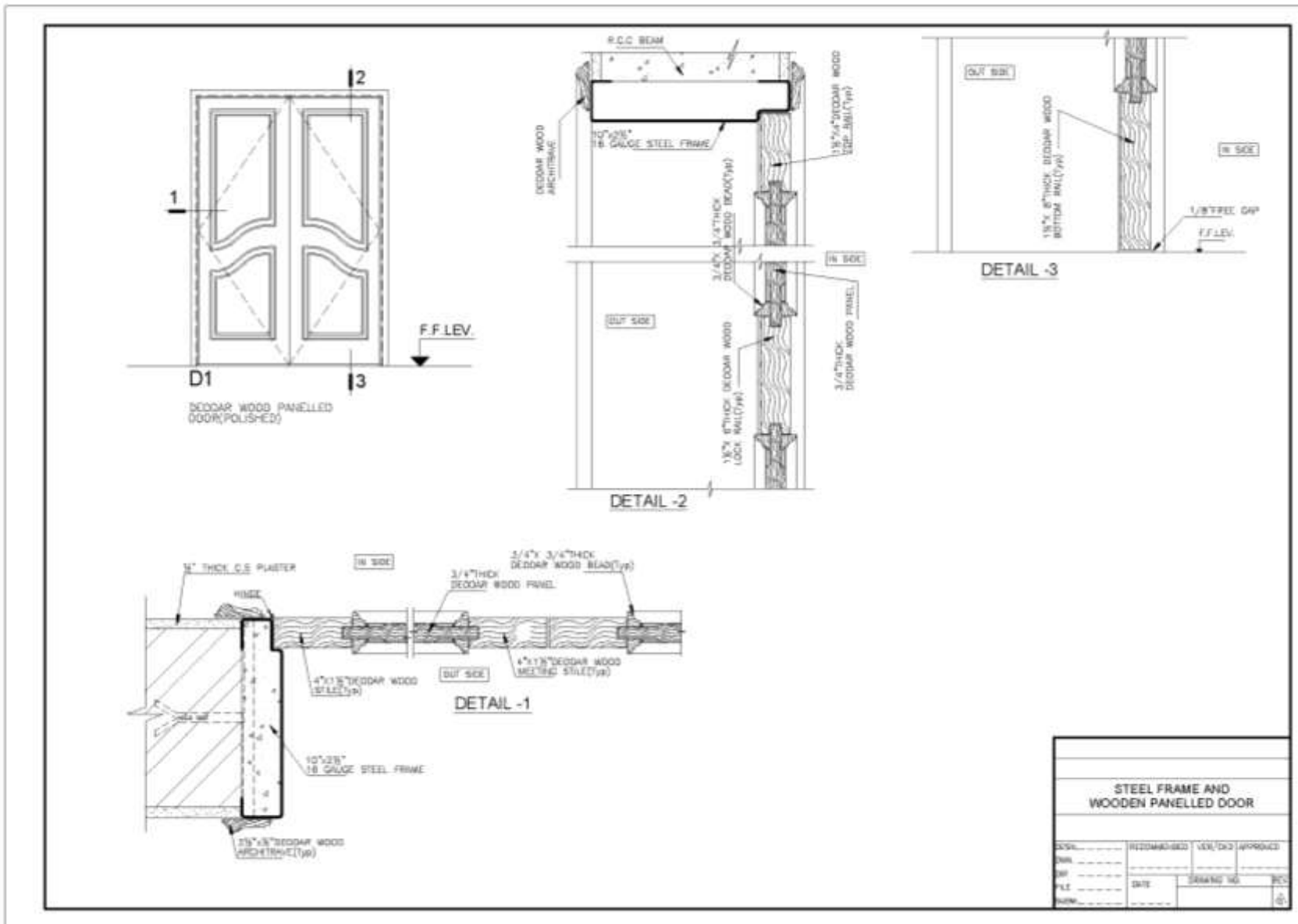

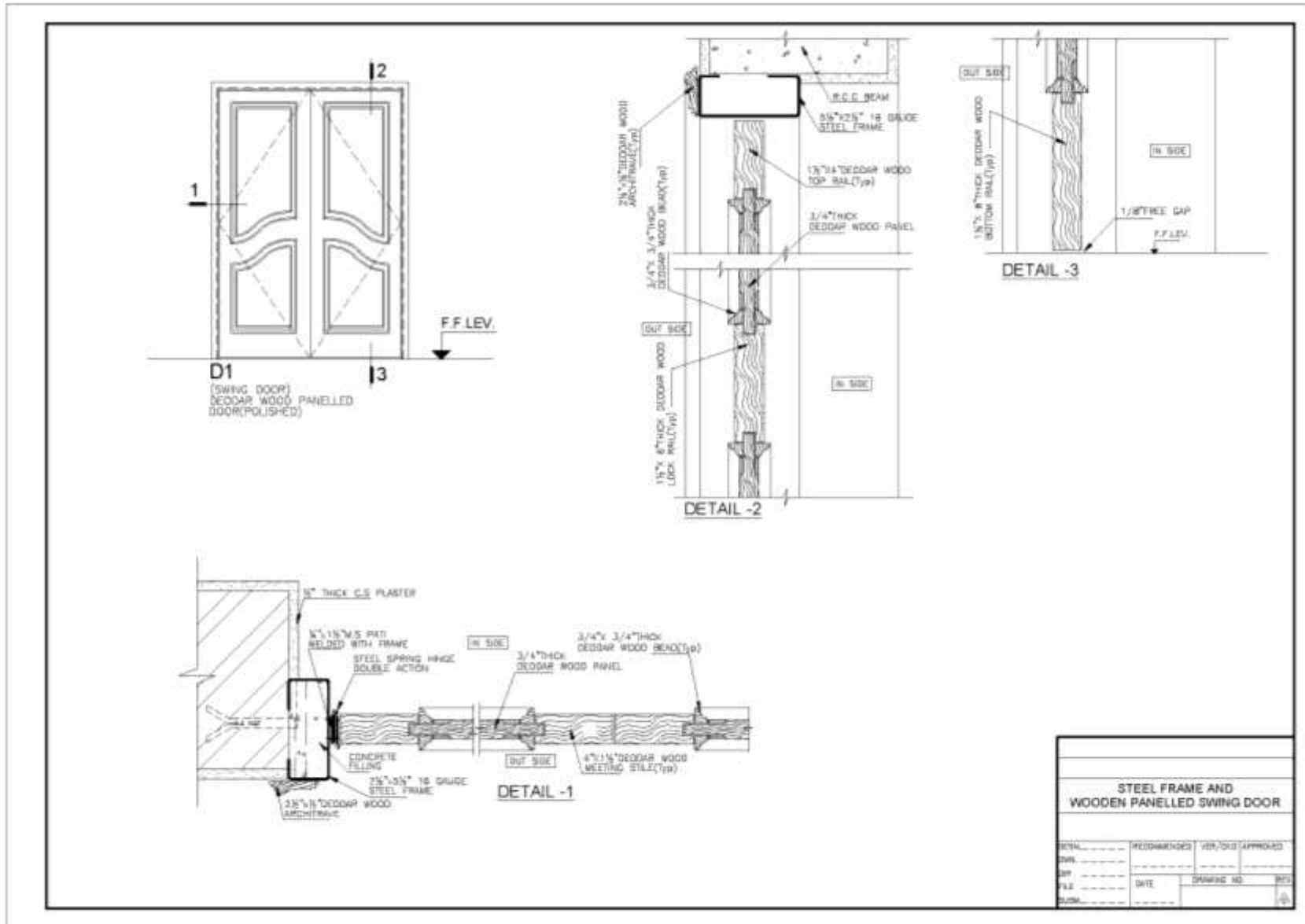

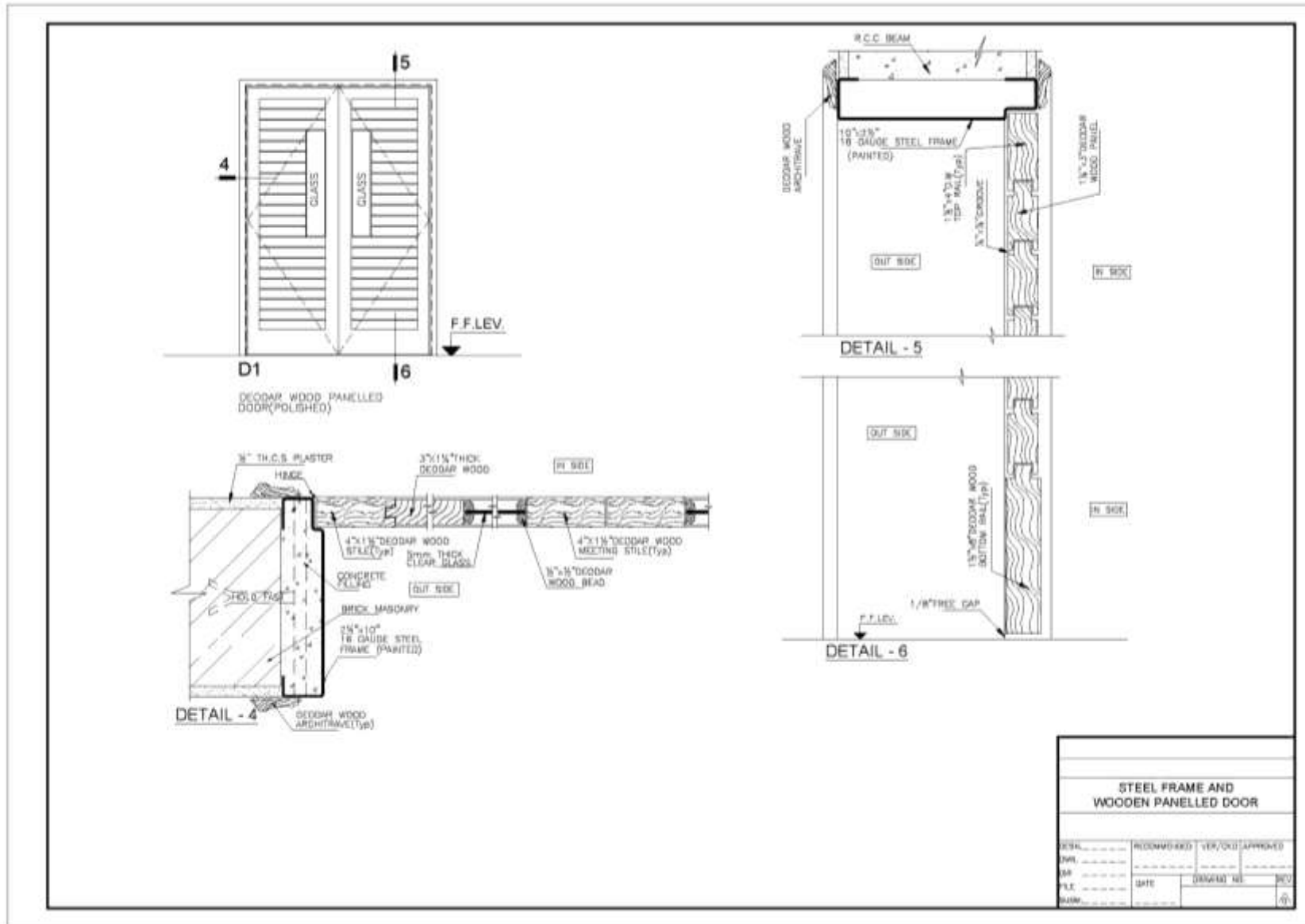

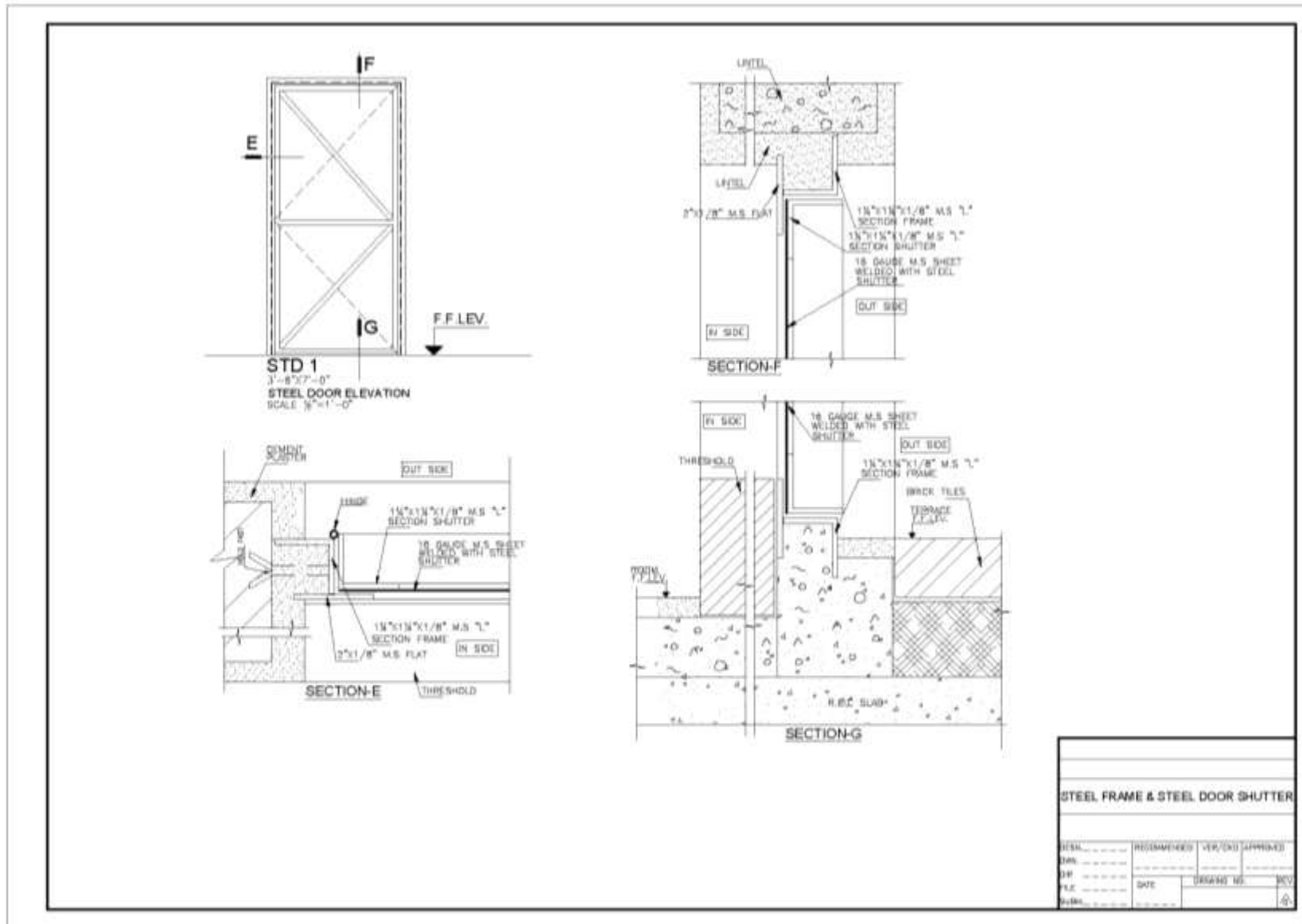

WINDOWS DRAWINGS & CROSS SECTIONS

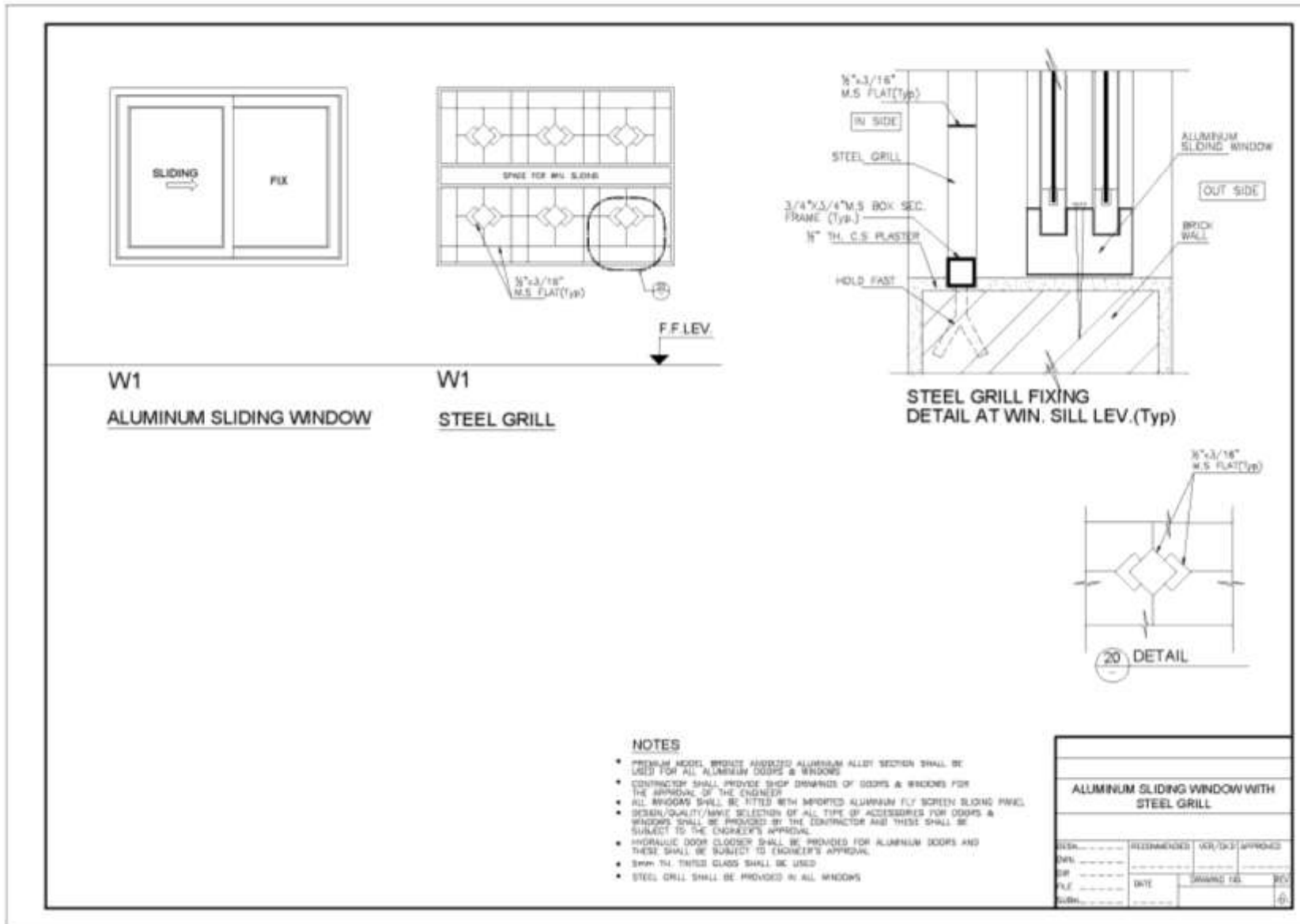

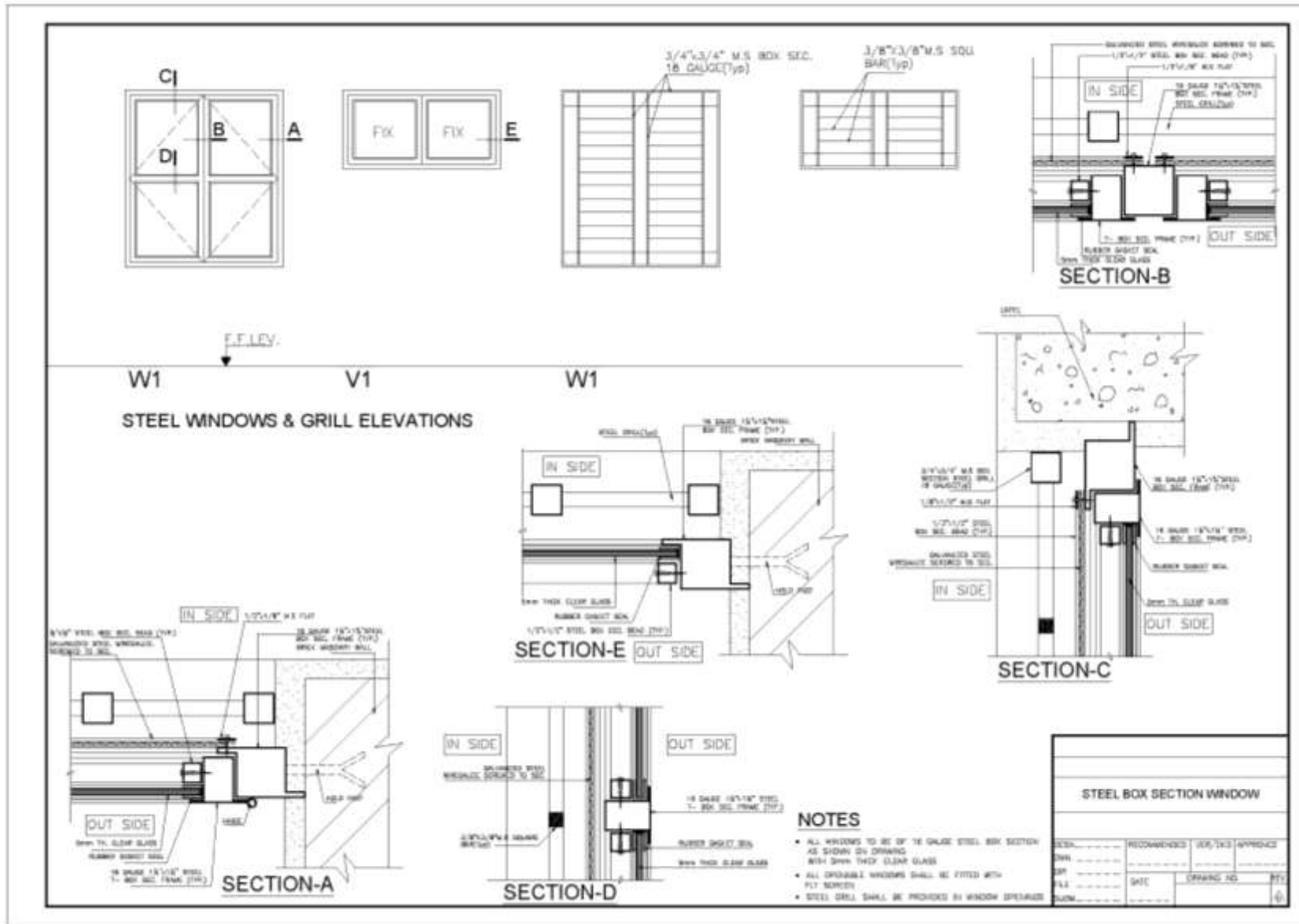

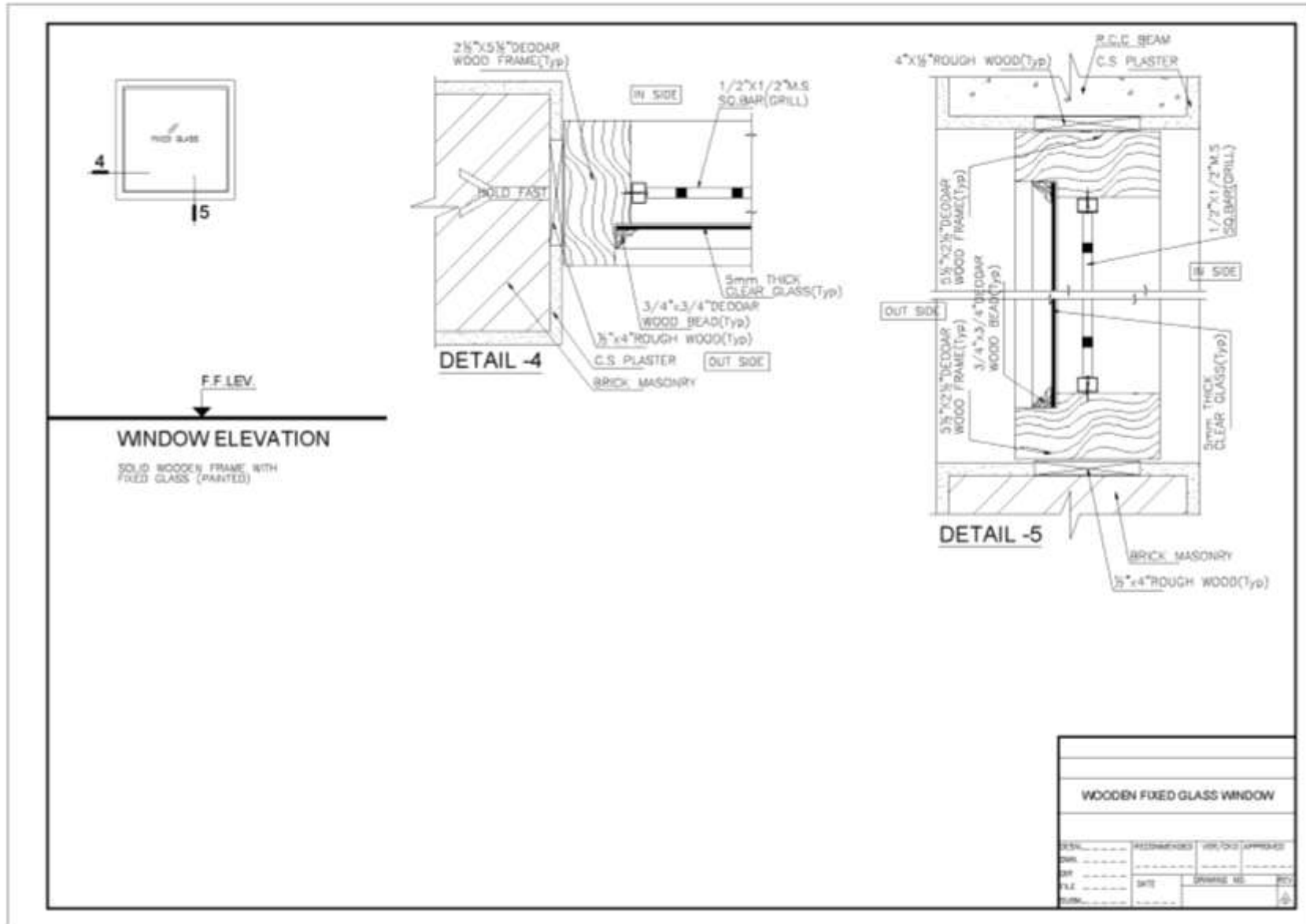

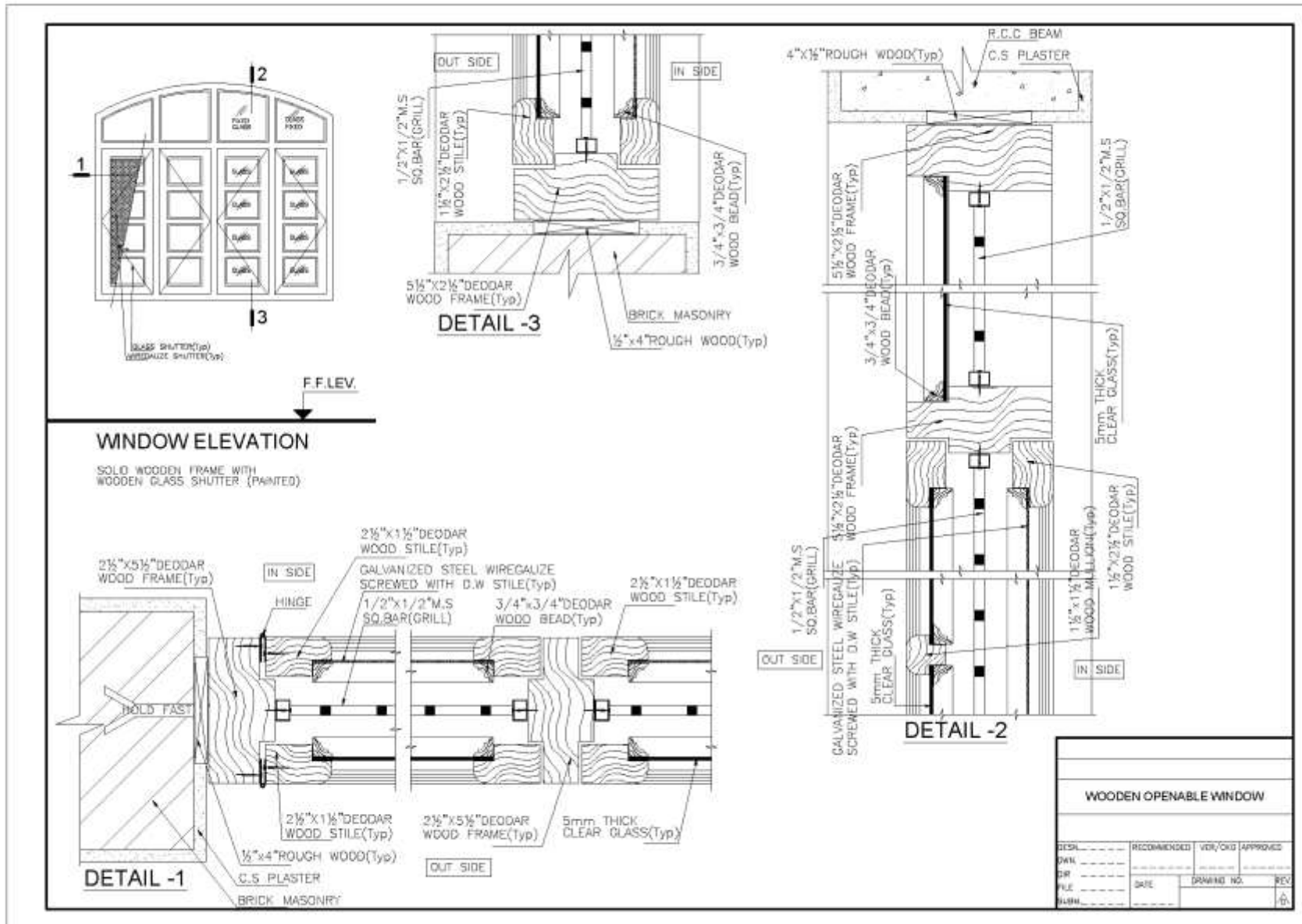

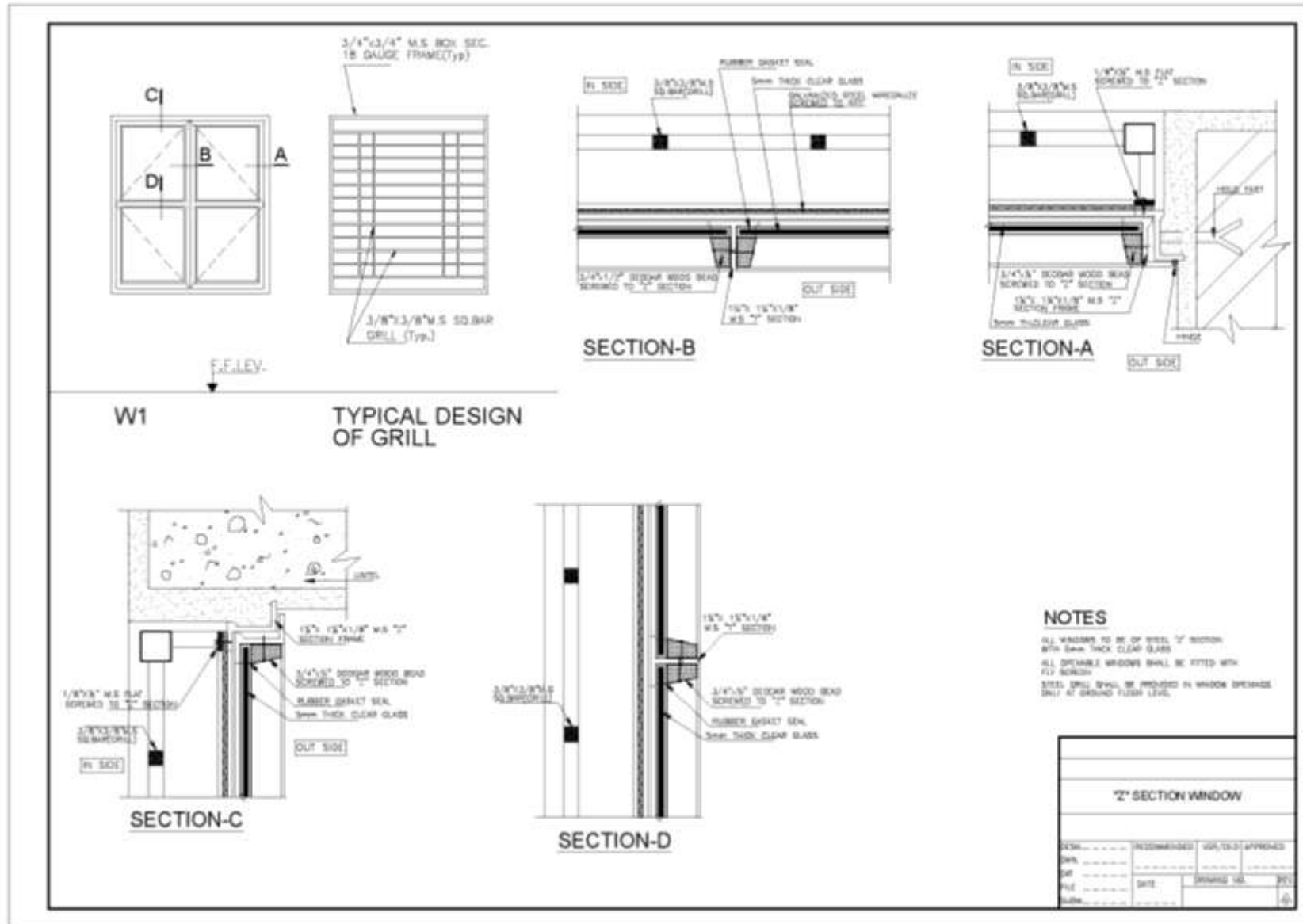

Contents

CHAPTER 13 PAINTING AND VARNISHING	4
13.1 General	4
13.1.1 Description.....	4
13.1.2 Glossary	4
13.1.3 Weather.....	11
13.1.4 Number of Coats	11
13.1.5 Cleaning and Preparing of Surface	11
13.1.6 Priming, Knotting and Stopping.....	12
13.1.7 Paint.....	12
13.1.8 Painting.....	12
13.1.9 Measurements.....	13
13.1.10 Rates.....	13
13.2 Painting New Wood Work	14
13.2.1 Preparation of Surface.....	14
13.2.2 Paint.....	15
13.2.3 Priming.....	15
13.2.4 Stopping	16
13.2.5 Painting.....	16
13.2.6 Measurement.....	16
13.2.7 Rates.....	16
13.3 Repainting Wood Works	17
13.3.1 Preparation of Surface for Repainting.....	17
13.3.2 Notes for Guidance.....	18
13.3.3 Fire Proof Paints for Woods Works.....	18
13.3.4 Painting.....	18
13.3.5 Measurements.....	19
13.3.6 Rates.....	19
13.4 Varnishing	19
13.4.1 Description.....	19
13.4.2 Preparation of Surface.....	20
13.4.3 Application	20
13.4.4 Measurement.....	20
13.4.5 Rates.....	20
13.5 French Polish	21

13.5.1	Description.....	21
13.5.2	Preparation of Surface.....	21
13.5.3	Materials	21
13.5.4	Preparation for Wax Polishing.....	21
13.5.5	Application.....	21
13.5.6	Measurement.....	22
13.5.7	Rate.....	22
13.6	Wax Polishing	22
13.6.1	Description.....	23
13.6.2	Preparation of Surface.....	23
13.6.3	Materials	23
13.6.4	Preparation for Wax Polishing.....	23
13.6.5	Application.....	23
13.6.6	Measurement.....	23
13.6.7	Rate.....	24
13.7	Oiling Wood Works.....	24
13.7.1	Scope.....	24
13.7.2	Linseed Oil Preparations.....	24
13.7.3	Oiling	25
13.8	Painting Wood Work with solignum or creosote or Coal Tar.....	25
13.8.1	Quality	25
13.8.2	Heating and Preparation	25
13.8.3	Other Respects	25
13.8.4	Measurements.....	25
13.8.5	Rates.....	26
13.9	Painting Iron Work above water	26
13.9.1	Weather.....	26
13.9.2	Preparation of Surface and Application of Paint	26
13.9.3	Number of Coats	27
13.9.4	Paints.....	27
13.9.5	Measurements.....	27
13.9.6	Rates.....	27
13.10	Painting Iron Work Which Remains Under Water.....	28
13.10.1	Preparation of Surface and Application of Paints.....	28
13.10.2	Painting Material.....	28
13.10.3	Number of Coats	28

13.10.4	Protection.....	28
13.10.5	Other Respects.....	28
13.10.6	Measurement.....	28
13.10.7	Rates.....	29
13.11	Coal Tarring Iron Work.....	29
13.11.1	Preparation of Surface.....	29
13.11.2	Heating and Preparing Tar.....	29
13.11.3	Application.....	29
13.12	Painting Plaster/concrete surfaces.....	29
13.12.1	General.....	29
13.12.2	Preparation of Surface.....	30
13.12.3	Priming Coat.....	30
13.12.4	Second and Third Coats.....	30
13.12.5	Fourth or Finishing Coat.....	30
13.12.6	Treatment of Newly Cement Plastered Surface.....	30
13.12.7	Measurements.....	31
13.12.8	Rate.....	31
13.13	Painting with Synthetic Enamel Paint.....	31
13.13.1	Painting on New Surface.....	31
13.13.2	Painting on Old Surface.....	32
13.13.3	Measurements.....	32
13.14	Weather shield Paint.....	32
13.14.1	Material.....	32
13.14.2	Construction Requirements.....	32
13.14.3	Measurement & Payment.....	32

CHAPTER 13 PAINTING AND VARNISHING

13.1 General

13.1.1 Description

This work shall consist of furnishing and application of paints, varnish and other protection to the surface of wood and metal in accordance with these specifications.

13.1.2 Glossary

By painting is meant the application of paint, varnish, enamel and other protective coating in a liquid form to the surface of wood, metal, brick, or other materials to form a thin coating or film which solidifies and sticks to the surface.

Preparation of wooden surface

Assuming the wood to be properly seasoned. The surface to be painted is prepared by carrying out operations of rubbing with fine grade sand paper, knotting, priming and stopping.

Rubbing

Rubbing is continued till the surface becomes perfectly smooth.

Knotting

Knotting is done before the application of a priming coat to cover all knots in wood so as to prevent any exudation of resin or any mark from showing, through the three common methods of knotting:

- i. Lime knotting
- ii. Ordinary size knotting, and
- iii. Patent knotting. Knots in deodar or other resinous woods are painted over with hot lime and scraped off after 24 hours.

Priming

Priming coat is the first coat applied to fill the pores of wood and prepare a smooth base for the subsequent painting.

Stopping

This mean the filling up of nail holes, cracks and other inequalities to level the surface.

French polish:

It is a spirit varnish applied to the prepared wood surface with a polishing pad and soft cloth and not with a brush, with quick and light strokes along the grains. The wood to be polished is first coated with a filler composed of 5 lbs. of whiting mixed with ½ gallon of methylated spirit and then sand papered, when dried.

Wax polish:

The prepared surface of woodwork is smeared with wax polish and rubbed with a soft flannel to a fine polish after 24 hours of its application. Wax polishing is mostly used for polishing the mosaic, marble and wooden floors.

Whitening:	Whiting is made by grinding pure white chalk to a fine powder. Then whiting mixed with zinc and water is used for whitening ceilings and walls.
Preparation for painting iron work:	It is essential to remove all rust, scale and dirt and have the surface absolutely cleaned before painting. Special attention is paid to the cleaning of corner and re-entrant angle.
Abrasion resistance:	The ability of a coating to resist being worn away and to maintain its original appearance and structure when subjected to wear.
Acid number:	The number of milligrams of potassium hydroxide (KOH) required to neutralize the free acids in 1g of an oil, resin, varnish, or other substance; generally reported on the nonvolatile content.
Additive:	A substance added in small quantities to another substance, usually to improve properties; sometimes called a modifier (for example, a drier, mildewcide, etc.).
Architectural coating:	Coating intended for on-site application to interior or exterior surfaces of buildings.
Baking finish:	A paint or varnish that requires baking at temperatures above 150°F (65°C) for the development of desired properties.
Bleeding:	The diffusion of coloring matter through a coating from the substrate; also, the discoloration arising from such diffusion.
Blistering Resistance:	The ability of a coating to resist the formation in the film of dome-shaped, liquid- or gas-filled projections resulting from local loss of adhesion and lifting of the film from the previously applied coating or the substrate.
Brush-drag:	Resistance encountered when applying a coating by brush, directly related to the high-shear viscosity of the coating.
Coating:	A liquid, liquefiable or mastic composition that is converted to a solid protective, decorative, or functional adherent film after application as a thin layer.
Coverage, coverage rate, covering power:	Terms that are used in some instances to refer to hiding power and in other to mean spreading rate.
Cracking resistance:	The ability of a coating to resist breaks of the film where the breaks extend through to the surface painted and the previously applied coating or the substrate is visible.

Crawling:	Defect in which the wet film recedes from localized areas of the substrate (usually caused by insufficient wetting) leaving those areas uncoated.
Dirt resistance:	The ability of a coating to resist soiling by foreign material, other than microorganisms, deposited on or embedded in the dried coating.
Drier:	A composition that accelerates the drying of oil, paint, or varnish. Driers are usually metallic compositions and are available in both solid and liquid forms.
Drying oil:	An oil that possesses to a marked degree the property of readily taking up oxygen from the air and changing to a relatively hard, tough, elastic substance when exposed in a thin film to the air.
Durability:	A relative term indicating degree of permanency. It may be applied to individual protective, decorative, or functional properties, for example, "the durability of gloss," but if used in a general way, for example, "the excellent durability of a paint," implies the ability of the described coating to retain, to the indicated degree, all the properties required for the continued service of the coating.
Efflorescence:	A condition that occurs when soluble salts in a dry coating or the substrate migrate to the surface due to the movement of water through the film; characterized by a (commonly) white, nonuniform powder or crystalline incrustation, not removable with neutral water but usually removed with dilute mineral acid.
Enamel:	A paint that is characterized by an ability to form an especially smooth film.
Erosion resistance:	The ability of a coating to withstand being worn away by chalking or by the abrasive action of water or windborne particles of grit. The degree of resistance is measured by the amount of the coating retained.
Extended pigments:	Organic pigments dilute with an extender (for example, alumina trihydrate, blanc fixe, or calcium carbonate).
Façade paint:	A decorative and protective coating for exterior masonry surface usually for buildings and walls.
Filler:	A pigmented composition for filling the pores or irregularities in a surface preparatory to application of other finishes.

Fire-retardant:	<p>A descriptive term which implies that the described product, under accepted methods of test, will significantly:</p> <ol style="list-style-type: none">reduce the rate of flame spread on the surface of a material to which it has been applied, orresist ignition when exposed to high temperatures, orinsulate a substrate to which it has been applied and prolong the time required to reach its ignition, melting, or structural-weakening temperature.
Finish	<p>(1) final coat in a paint system; at the termination of cure or drying</p> <p>(2) sometimes refers to the entire coating system: the texture, color, and smoothness of a surface, and other properties affecting appearance.</p>
Flaking resistance:	<p>The ability of a coating to resist the actual detachment of film fragments either from the previously applied coating or the substrate. Flaking is generally preceded by cracking, checking, or blistering and is the result of loss of adhesion. Also known as scaling resistance.</p>
Flatting agent:	<p>A material added to paints, varnishes, and other coating materials to reduce the gloss of the dried film.</p>
Grit:	<p>The coarse foreign particles in paint materials and coatings, often of irregular shape, that are hard, abrasive, and resistant to disintegration.</p>
Hiding power:	<p>The ability of a paint, or paint material as used, to hide or obscure a surface to which it has been uniformly applied. When expressed numerically, it is generally in terms of the number of square feet over which a gallon of paint, or pound of pigment, as used, can be uniformly spread to produce a specified contrast ratio.</p>
Hydroxyl number:	<p>The number of milligrams of potassium hydroxide (KOH) equivalent to the hydroxyl content of 1g of sample.</p>
Lacquer:	<p>A coating composition that is based on synthetic thermoplastic film-forming material dissolved in organic solvent that dries primarily by solvent evaporation. Typical lacquers include those based on nitrocellulose, other cellulose derivatives, vinyl resins, acrylic resin, etc.</p>
Lap:	<p>The region where one area of a coated surface merges into an adjacent freshly-coated area during application of a single coat to the entire surface.</p>

Levelling:	The process whereby a film of liquid coating flows out after application so as to minimize any surface irregularities such as brush marks, orange peel, peaks, or craters, that have been produced by the mechanical process of application (2) a measure or rating of the levelling ability of a coating.
Mottling:	The presence in the surface of a film, of irregularly shaped, randomly distributed areas that vary in color, gloss, or sheen, causing the film to be non-uniform in appearance, also known as blotching.
Mud-cracking:	An irregular broken network of cracks in the film, which occurs due to volatile loss while drying or curing.
Natural spreading rate:	The spreading rate that occurs when a coating is applied in a manner natural to the operator's technique, perceptions, and expectations, as they relate to coating tools, substrate, and characteristics of the coating itself.
Paint:	A pigment coating.
Paint brush:	A paint application tool consisting of a flexible brushing art composed of long filamentary material (brushing material) bound to a handle.
Paint brush bristle:	Hair of the swine (for example: pig, hog, boar), used in brushing material.
Paint brush ferrule:	Outer band that joins the brushing material to the handle.
Paint brush filament:	A synthetic polymer extrusion used in brushing material.
Paint brush head:	Brush without the handle.
Paint brush length clear:	Also called "length out", the exposed length of the brushing material from the ferrule to the tip end.
Paint brush thickness:	Measurement of the brush material across the narrow opening of the ferrule.
Paint roller:	A complete paint application tool consisting of a roller frame and a roller cover designed to apply paint by a rolling action.
Paint roller core:	A structural tube that forms the base of the roller cover to which paint applying material is attached.
Paint roller cover:	A tubular sleeve consisting of a paint applying material secured to a core.

Paint roller frame:	A frame and handle assembly designed to hold a roller cover.
Pigment:	The fine solid particles used in the preparation of paint and substantially insoluble in the vehicle.
Pigment volume:	The percent by volume of pigment in the nonvolatile portion of a paint as calculated from bulking value and composition data. The letters PV are commonly used as an abbreviation.
Pinholes:	Small pore-like flaws in a coating that extend entirely through the applied film and have the general appearance of pin pricks when viewed by reflected light.
Pin-holing:	The present of a series of fine holes or voids in a film.
Plasticizer:	A substance added to paint, varnish, or lacquer to impart flexibility.
Putty:	A dough-like material consisting of pigment and vehicle, used for sealing glass in frames, and for filling imperfections in wood or metal surfaces.
Resin, natural:	A solid organic substance, originating in the secretion of certain plants or insects, which is thermoplastic, flammable, nonconductive of electricity; breaks with a conchoidal fracture (when hard); and dissolves in certain specific organic solvents but not water.
Resin, synthetic:	<p>A synthetic substance physically similar to natural resin.</p> <p>Acrylic resin A synthetic resin made from derivatives of acrylic acid.</p> <p>Alkyd resin A synthetic resin made from polyhydric alcohols and polybasic acids; generally modified with resins, fatty oils or fatty acids.</p> <p>Ester gum A resin made from rosin or rosin acids and a polyhydric alcohol, such as glycerin or pentaerythritol.</p> <p>Maleic resin A resin made from a natural resin & Mobic anhydride or maleic-acid. Melamine resin a synthetic resin made from melamine and aldehyde.</p> <p>Penta resin Easter gum made from rosin and pentaerythritol.</p> <p>Phenolic resin A synthetic resin made from phenols and aldehydes.</p> <p>Styrene resin A synthetic resin made from vinyl benzene.</p>

Urea resin

A synthetic resin made from urea and an aldehyde.

Vinyl resin

A synthetic resin made from vinyl compounds.

- Rust:** The reddish material, primarily hydrated iron oxide, formed on iron or its alloys resulting from exposure to humid atmosphere or chemical attack.
- Rust resistance (coatings):** The ability of a coating to protect the substrate of iron or its alloys from rusting.
- Sag or sagging:** Nonuniform downward flow of a wet paint film that occurs between the times of application and setting, resulting in an uneven coating having a thick lower edge.
- Sealer:** A liquid composition to prevent excessive absorption of finish coats into porous surfaces; also, a composition to prevent bleeding.
- Shade:** A term descriptive of a lightness difference between surface colors, the other attributes of color being essentially constant. A lighter shade of a color is one that has higher lightness but approximately the same hue and saturation; and a darker shade is one that has a lower lightness. Primarily, the term "shade" is derived from shadow and designates a change in appearance analogous to that produced by a local reduction in illumination. It should, therefore, when strictly used, express only the change toward a darker color. Shade of a color has been defined by several authorities as the mixture of black with that color, thus establishing its opposite character to "tint", but by extension of its relative sense it has been frequently and widely used to include lighter shades by use of the adjective "lighter" or "paler". Although such expressions apparently involve a contradiction, it is clear that while we may have a shade of a color or darker color of the same sort, it is easy to conceive of another shade not quite so dark and therefore lighter.
- Soil (of coating):** Disfiguring foreign materials such as dirt, soot, or stain, other than microorganisms, deposited on or embedded in a dried film of applied coating material; also called dirt.
- Spreading rate:** The area covered by a unit volume of coating material frequently expressed as square feet per gallon.
- Stain:** A discoloration, arising from foreign materials, that penetrates into the coating.
- Temporary coating:** A coating designed to protect or decorate a substrate for a limited time that can be readily removed either by mechanical or chemical means.

- Thinner:** The portion of a paint, varnish, lacquer or related product that volatilizes during the drying process.
- Varnish:** A liquid composition that is converted to a transparent or translucent solid film after application as a thin layer.
- Bituminous varnish**
A dark-colored varnish containing bituminous ingredients. The varnish may be either of the oil or spirit type.
- Oil varnish**
A varnish that contains resin and drying oil as the basic film-forming ingredients and is converted to a solid film primarily by chemical reaction.
- Spar varnish**
A varnish for exterior surfaces. The name originated from its use on spars of ships.
- Spirit varnish**
A varnish that is converted to a solid film primarily by solvent evaporation.
- Vehicle:** The liquid portion of a paint. Anything that is dissolved in the liquid portion of a paint is a part of the vehicle.
- Waterborne coating:** A coating in which the principal volatile constituent is water.

13.1.3 Weather

Unless otherwise specified, no painting shall be done during wet, foggy or dusty weather or in the direct rays of the hot sun.

13.1.4 Number of Coats

Unless otherwise specified, all wood and iron surfaces shall be given three coats, including the priming coat.

13.1.5 Cleaning and Preparing of Surface

1. Surface shall be thoroughly cleaned of all dust, rust, dirt, oil, grease, old paint etc., and rendered smooth and dried before preparing it for painting or varnishing.
2. **For Repainting of Surface:** If the old surface is firm and sound, it is rubbed with pumice or soap stone and washed thoroughly with soap, washing soda and water. Afterwards all those processes like knotting, priming stopping and rubbing are carried out to obtain a properly prepared surface for second and subsequent coats of repainting. If the old paint is in a blistered, cracked or perished condition it has to be completely removed and the surface prepared afresh for painting. Surface marked with smoke or otherwise dirty is cleaned by applying a coat of 3 Lbs..glue and 3 oz un-slaked lime boiled in one gallon of water. Greasy places are brushed over with turpentine and then washed with lime/soap and water.

13.1.5.1 Paint Removers

There are a number of ready-made paint removers. If none is available, any one of the following methods can be used for removing the old paint:

1. A coat of caustic soda (2Lbs. of caustic soda to a gallon of water) may be applied very carefully with a piece of cloth securely tied on one end of a long wooden stick. It is very dangerous and harmful to the eyes and skin, and, therefore, should never be touched by hand. A few hours after it has been applied the surface is thoroughly washed with clean water and neutralized with a weak acid solution or vinegar.
2. Old paint may be softened by repeated application of naphtha. The surface can be then rubbed and cleaned.
3. One Lb. of country soda (saji) may be dissolved in hot water and mixed with stone lime to make a creamy paste. The surface to be cleaned is well coated with it and kept moist for at least 3 hours. The paint would become soft and can be easily rubbed off. To quicken the action un-slaked lime may be used and the mixture applied hot.
4. One part of soft soap may be mixed to two parts of potash and the mixture dissolved in boiling water. Then lime is added to it. This mixture may be applied while it is still hot, with a brush on the surface of the old paint and left on for 12 to 18 hours. It would soften the paint which can be easily removed by washing with hot water.
5. Sodium carbonate or washing soda diluted with water would clean greases and fats from the old painted surface. (One lb of washing soda is sufficient for one gallon of water) Hot water would quicken the action of washing soda.
6. Two parts of quicklime may be mixed with one part of washing soda and made to the consistency of a cream. A coat of this cream would soften the old paint very quickly.
7. Burning the paint preferably with a blow pump and scraping.

13.1.6 Priming, Knotting and Stopping

A priming coat without colouring matter shall first be applied, after which all holes, cracks, knots, etc., shall be stopped with the specified putty.

13.1.7 Paint

Paint shall be of an approved make and quality.

13.1.8 Painting

- a. Paint shall be applied with proper brushes of approved quality or spraying machine as specified.
- b. Paint shall be constantly stirred, while it is being applied. It shall be stirred with a smooth stick and under no circumstances with a brush.
- c. When more than one coat has to be given, every coat must be completely dry, rubbed and all dust removed before the next is applied.
- d. Each coat shall differ slightly in tint from the preceding one, to distinguish quickly between each coat. The last coat shall be of the tint required for the finished work.
- e. Each coat shall be approved by the Engineer-in-charge before the next is applied.
- f. All coats shall be applied evenly and properly, so that the work does not show any hair or brush marks, or drops of paints. The method of crossing and laying off shall be normally applied, the latter in the direction of grains in the case of wood work.
- g. Paint, when not in use, shall be kept away from the air. The surface of the kegs of ground and mixed paints which have been partly used shall be covered with water.

13.1.8.1 Painting with Spraying Machine

When spraying machines are being used for painting the instructions given below should be followed.

- a) The gun should be held 6 to 10 inches from the object to be painted. Gun should be moved across the surface with steady and even strokes made with a free arm action. The gun should be kept perpendicular to and at an equal distance from the surface throughout the operation. Before actual work, gun should be tried on a cardboard surface, etc.
- b) The adjusting screw on the gun should be closed while starting and opened gradually till the spray runs right. A distorted spray indicates dirty air caps in which case it should be taken off and washed carefully in a clean solvent.
- c) Spray painting should not be employed for paints containing lead or for painting joinery work which should

13.1.9 Measurements

Painting and varnishing shall be measured by superficial area. The unit of measurement shall be 100 square feet or one square meter. Moulded work of all kinds, unless otherwise specified, shall be measured by running the tape over and into all elevations and depressions. In the case of other classes of work painted on both sides the flat area of the surface on one side, including glazing and chowkat, shall be multiplied by the factors given below to arrive at the correct measurement of both sides for the purpose of making payment.

a. Paneled or battened doors and windows	2 times
b. Glazed or partly glazed doors or windows	2 times
c. Plate glass windows (large glazed area)	1 time
d. Wire gauze doors or windows	1 time
e. Trellis work	2 times
f. Grated doors and windows and other grating	1 time
g. Palisade fencing	0.6 time

Note: In the case of chowkat having two rebates, one for wooden door and the other for wire gauze shutter, the surface area of the chowkat shall be included in the measurement of only one door.

13.1.10 Rates

13.1.10.1 Labour Rate

The unit rate shall include the cost of cleaning, preparing and painting the surface according to the above specifications or any other specifications specially included in the contract. It shall further include the cost of providing, using and removing scaffoldings, supports, ladders, shot with gunny bags at both ends, brushes or spraying machines of approved type and any other tool or plant required for doing painting as per above specifications and removal with turpentine or other approved methods of all defects from the painted surface to leave it perfect in every respect. It shall further include the cost of all allied operations like the removal of stains, smears, splashes and droppings on the walls, floors, glazing, furniture and other places.

13.1.10.2 Composite Rate

The unit rate shall include the cost of supplying paints of approved quality, paint remover in case of painting old work and all other material required for doing painting as per above specifications at site of work in addition to the labour rate as detailed in Heading 13.1.10.1.

13.2 Painting New Wood Work

The surface to be painted must be properly prepared because a large number of defects, appearing afterwards can be attributed either to faulty preparations or to the improper season of wood.

13.2.1 Preparation of Surface

Assuming the wood to be properly seasoned. The surface is prepared by carrying out following operations in succession.

- a. Rubbing with Pumice or Medium and Fine Grade Sand Paper - This rubbing is continued till the Surface becomes perfectly smooth.
- b. Knotting - This is done before the application of a priming coat to cover all knots in wood so as to prevent any exudation of resin or any mark from showing, through the three common methods of knotting: (i) Lime knotting (ii) Ordinary size knotting, and (iii) Patent knotting. Knots in deodar or other resin-outs woods are painted over with hot lime and scraped off after 24 hours. The knots are primed with red lead and glue is laid hot on them. A coat of knotting varnish is then applied and the surface is rubbed smooth with pumice stone or sand paper.
Ordinary size knotting is applied in two coats. The first is made by grinding red lead in water and mixing it with strong glue size used hot. The coat dries in about 10 minutes. The second coat consists of red lead ground in oil and thinned with boiled linseed oil and turpentine.
Patent knotting consists of two coats of a varnish made by dissolving shellac in methylated spirit or naphtha. Knotting may be composed of 5 oz. of pure shellac dissolved in a pint of methylated spirit. After it has been thoroughly dissolved, ½-oz. or red lead is put into it and stirred. This is suitable for general purpose.
- c. PRIMING - Priming coat is the first coat applied to fill the pores of wood and prepare a smooth base for the subsequent coats of paints. It also quickens their drying. A priming coat may be of red lead. or red and white lead mixed in double boiled linseed oil (7 lbs. of red lead or 7 lbs. or red and white lead; mixed with ¾ of a gallon of oil) and may be applied with a brush or spraying machine.
- d. STOPPING - This means the filling up of nail holes, cracks and other inequalities to level the surface. Stopping is done as soon as the priming coat dries up, with ordinary putty made of 2 parts of whiting, 1 part of white lead, mixed together in linseed oil and kneaded (3 oz. linseed oil 1 lb. of whiting). High class interior work can be stopped with a mixture of ⅓ of white lead and ⅔ of ordinary putty. In the case of varnishing, the wood surface is usually stopped with hot weak glue size (one lb. of glue making about one gallon of size). When the surface dries up, it is thoroughly sand-papered. Stopping out wax is also a very useful preparation for concealing defects in wooden surfaces to be polished. It is applied hot and sets quite hard. As it does not take stains after setting, it should be coloured during its preparation to suit the finished work.

13.2.1.1 Rubbing with Pumice or Medium and Fine Grade Sand Paper

Unless otherwise specified, wood work to be painted shall be finished smooth with the plane, but free from plane marks of every kind and rubbed smooth with sand paper, first with 2½ (medium) grade and then with 1½ (fine) grade or pumice stone.

13.2.1.2 Knotting

After rubbing all knots in the wood, it shall be killed or covered with: -

- a. Two coats of patent (approved) knotting (shellac dissolved in naphtha) or
- b. Shellac varnish (5 oz shellac mixed with 1 pint of methylated spirit of vine, thoroughly dissolved and stirred with ½ oz red lead) or
- c. A preparation of red lead and glue size in equal weight applied hot. Knots in deodar or other resinous wood shall be painted over with hot lime. This paint shall be scraped off after 24 hours, the knots primed with red lead and glue aid hot. Then one coat of knotting varnish shall be applied.

13.2.2 Paint

Paint shall be of an approved make and quality.

13.2.3 Priming

Woodwork shall be properly primed before being fixed in position. In the absence of approved ready-made priming paint, it shall be prepared by mixing the following ingredients: -

- a. For inside work (except in white and very pale shade): -

i. White lead	10 lbs.
ii. Red lead	¼ lbs.
iii. Boiled linseed oil	4 pints
iv. Raw linseed oil	2 pints
v. Turpentine	1 pint

- b. For outside work: -

i. White lead	10 lbs.
ii. Red lead	¼ lbs.
iii. Boiled linseed oil	2 pints
iv. Raw linseed oil	4 pints
v. Turpentine	1 pint

- c. For white or light shade: -

i. White lead	16 lbs.
ii. Lamp black	½ lbs.
iii. Raw linseed oil	5 pints
iv. Turpentine	1 pint

- d. Genuine white lead: 7 lbs.
 - i. Genuine red lead 7 lbs.
 - ii. Boiled linseed oil 1gallon

or

 - i. White lead 15 lbs.
 - ii. Red lead 0.30 lbs.
 - iii. Litharge (drier) 0.30 lbs.

- iv. Linseed oil 6.50 pints

The priming paints shall be applied either by brushes or by spraying machines as specified.

13.2.4 Stopping

After priming, all holes, cracks, gapping, joints and similar other defects shall be stopped with putty manufactured by approved manufacturer.

13.2.5 Painting

After having prepared the surface in the manner described above, a second coat of paint of the desired quality and colour is applied exactly in the same fashion as the priming coat. As soon as it dries up, the surface is rubbed with pumice stone or glass paper. This is followed by second and subsequent coats. Each coat is allowed to dry completely before the next is applied. Thin coats of paint are preferable; for thick coats not only take longer time to dry up but also scale off after some time in the form of blisters.

Turpentine instead of oil is used for the surface which is exposed to strong sunlight because oil paints show up all defects. The proportions used are 2 lbs. of white zinc, 1 lb. of turpentine and ½ lb. of boiled linseed oil. For painting white, lead is used for the surface exposed to weather and white zinc for interior works. If lead paint has been used, dry rubbing of surface should not be done on any account, since it causes lead poisoning among painter. Instead, waterproof sand papers or flint paper and cloth should be used.

Note: Woods having an excess of resin or oils are unsuitable for polished or painted work, e.g. the resin of deodar shows itself up in the discoloured patches even through a number of coats of paint.

13.2.6 Measurement

Painting shall be measured by superficial area. The unit of measurement shall be 100 square feet or one square meter. Moulded work of all kinds, unless otherwise specified, shall be measured by running the tape over and into all elevations and depressions. In the case of other classes of work painted on both sides the flat area of the surface on one side, including glazing and chowkat, shall be multiplied by the factors given below to arrive at the correct measurement of both sides for the purpose of making payment.

a. Paneled or battened doors and windows	2 times
b. Glazed or partly glazed doors or windows	2 times
c. Plate glass windows (large glazed area)	1 time
d. Wire gauze doors or windows	1 time
e. Trellis work	2 times
f. Grated doors and windows and other grating	1 time
g. Palisade fencing	0.6 time

Note: In the case of chowkat having two rebates, one for wooden door and the other for wire gauze shutter, the surface area of the chowkat shall be included in the measurement of only one door.

13.2.7 Rates

13.2.7.1 Labor Rates

The unit rate shall include the cost of cleaning, preparing and painting the surface according to the above specifications or any other specifications specially included in the contract. It shall further include the cost of providing, using and removing scaffoldings, supports, ladders, shot with gunny bags at both ends, brushes or spraying machines of approved type and any other tool or plant required for doing painting as per above specifications and removal with turpentine or other approved methods of all defects from the painted surface to leave it perfect in every respect. It shall further include the cost of all allied operations like the removal of stains, smears, splashes and droppings on the walls, floors, glazing, furniture and other places.

13.2.7.2 Composite Rates

The unit rate shall include the cost of supplying paints of approved quality, paint remover in case of painting old work and all other material required for doing painting as per above specifications at site of work in addition to the labour rate as detailed in Heading 13.2.7.1.

13.3 Repainting Wood Works

Repainting of wooden surface is done in the same manner as the Original painting; the difference lies only in the preparation of the surface.

13.3.1 Preparation of Surface for Repainting

- a. If the old paint is firm and sound the surface shall be rubbed with pumice stone and washed thoroughly with soap, washing soda and water till all dirt, grease, projections and blisters, if any, are removed and the surface is rendered smooth.
- b. Surfaces spoiled by smoke shall be cleaned by the application of a coat of 3 lbs. glue and 3 oz, unsalted lime boiled in one gallon of water, unless otherwise specified.
- c. Greasy surfaces shall be cleaned by applying a coat of turpentine over them and then washing them with soap and water.
- d. When the old paint is in a blistered, cracked or perished condition, it shall be completely removed by burning off with a blow lamp or by means of a paint remover as specified or directed by the Engineer-in-charge. The blow lamp shall not be used on curved surfaces or surfaces adjoining glass, such as sashes, etc. Care shall be taken that the wood surfaces are not charred.
- e. When a ready-made paint remover of an approved quality is not available any one of the following recipes shall be used, unless otherwise specified.
 - i. Naphtha shall be applied repeatedly till the paint has softened. The surface shall then be rubbed and cleaned.
 - ii. A coat of caustic soda (2 lbs. of caustic soda to a gallon of water) shall be applied very carefully by means of a piece of cloth securely tied on one end of a long wooden stick. After a few hours of its application the surface shall be thoroughly washed with clean water and neutralized with a weak acid solution or vinegar. This paint remover shall be applied only when particularly specified and permitted by the Engineer-in-charge and shall not be touched by hand or allowed to come in direct contact with the wood.
 - iii. One lb. of country soda (sajji) shall be dissolved in hot water and mixed with lime stone reducing the whole to a creamy paste. The surface shall be coated with it and kept moist for at least 3 hours. If the lime used is unslaked and the mixture is applied hot, the action shall be quickened.

- iv. One part of soft soap shall be mixed to two parts of potash and the mixture dissolved in boiling water. Four parts of lime shall then be added to it and applied (while it is hot) with a brush on the surface of the paint and left on for 12 to 18 hours.
- v. Sodium carbonate or washing soda, diluted with water, cleans grease and fat from the old painted surface. One lb. of washing soda shall be sufficient for one gallon of water. Hot water quickens the action of washing soda.
- vi. Two parts of quick lime shall be mixed with one part of washing soda and made to the consistency of a cream. A coat of this cream shall soften the painted surface.
- vii.

a. Palmitic acid (vegetable)	25 parts by weight
b. Benzine	35 parts by weight
c. Amyl acetate	40 parts by weight

 This solution shall be applied by brush.
- viii.

a. Caustic soda	14 lbs.
b. Whiting	9 lbs.
c. Flour	2½ lbs.
d. Petroleum	2½ gallons
e. Water	7 gallons

 The solution shall be applied by any approved method on the surface.
- f. After the paint has been removed the surface shall be rubbed smooth with sand paper, washed down and allowed to dry completely. It shall be wiped clean before paint is applied.
- g. After rubbing all holes, cracks and other inequalities, the surface shall be properly stopped in the manner specified under "Painting New Wood Work".

13.3.2 Notes for Guidance

- Painting should be avoided during wet season.
- No painting should be done on a stormy or rainy day.
- Painted surface should not have any brush marks, runs or specks.
- If the wet painted surface is spoiled by any weathering action it should be rubbed and painted afresh.
- The paint should have a proper consistency. It should not be thinned down so much that it flows off the brush when it is being applied.

13.3.3 Fire Proof Paints for Woods Works

A coating of paint of insulating and non-combustible type sodium silicate or ammonium phosphate acts as an efficient fire retardant. The chemicals decompose on painting and give out non-combustible gases and water vapors which dilute the inflammable gasses and retard the combustion of wood. They also form readily a dense layer of charcoal and a fused viscous mass and protect the wood from radiant heat. The surface of wood is thus cut off from the supply of oxygen.

13.3.4 Painting

- a. After preparing and treating the surface, it shall be painted according to Heading 13.2 of these specifications for "Painting New Wood Work".
- b. If old paint is completely removed the cost of removal is not to be included in the rate for first coat, but shall be payable separately.

- c. If old paint is firm and is not removed completely but the surface is only rubbed and treated, the rate for the first coat of paint shall include the cost of treatment also.

13.3.5 Measurements

Painting shall be measured by superficial area. The unit of measurement shall be 100 square feet or one square meter. Moulded work of all kinds, unless otherwise specified, shall be measured by running the tape over and into all elevations and depressions. In the case of other classes of work painted on both sides the flat area of the surface on one side, including glazing and chowkat, shall be multiplied by the factors given below to arrive at the correct measurement of both sides for the purpose of making payment.

- | | |
|-----------------------------------------------|----------|
| a. Paneled or battened doors and windows | 2 times |
| b. Glazed or partly glazed doors or windows | 2 times |
| c. Plate glass windows (large glazed area) | 1 time |
| d. Wire gauze doors or windows | 1 time |
| e. Trellis work | 2 times |
| f. Grated doors and windows and other grating | 1 time |
| g. Palisade fencing | 0.6 time |

Note: In the case of chowkat having two rebates, one for wooden door and the other for wire gauze shutter, the surface area of the chowkat shall be included in the measurement of only one door.

13.3.6 Rates

13.3.6.1 Labor Rates

The unit rate shall include the cost of cleaning, preparing and painting the surface according to the above specifications or any other specifications specially included in the contract. It shall further include the cost of providing, using and removing scaffoldings, supports, ladders, shot with gunny bags at both ends, brushes or spraying machines of approved type and any other tool or plant required for doing painting as per above specifications and removal with turpentine or other approved methods of all defects from the painted surface to leave it perfect in every respect. It shall further include the cost of all allied operations like the removal of stains, smears, splashes and droppings on the walls, floors, glazing, furniture and other places.

13.3.6.2 Composite Rates

The unit rate shall include the cost of supplying paints of approved quality, paint remover in case of painting old work and all other material required for doing painting as per above specifications at site of work in addition to the labour rate as detailed in Heading 13.3.6.1.

13.4 Varnishing

13.4.1 Description

This work shall cover varnishing of wooden surface in accordance with these specifications.

13.4.2 Preparation of Surface

- a. New woodwork to be varnished shall be finished smooth with the plane making sure that no marks are visible on the finished surface. It shall be rubbed perfectly smooth with sand paper or pumice stone.
- b. Knotting shall be done as specified in Heading 13.2.1.2 of these specifications for "Painting New Woodwork".
- c. Stopping – The surface of the wood shall be then stopped, with hot weak glue size (1 lb. of glue making about 1 gallon of size) so as to close up the holes. The surface when it dries up shall be again thoroughly sand papered. After rubbing the surfaces another coat of the same glue size shall be applied cold.
- d. If the woodwork is to be stained, the staining colour shall be mixed with second coat of size which shall be applied regularly, evenly and quickly keeping the colour on the flow.
- e. If the woodwork is of an oily nature, a little 'Multani Mitti' and ochre shall be added to the first coat of size (otherwise varnish would not dry readily).
- f. The sized wood shall then be rubbed with sand paper leaving the colour even and rubbing with the grain.

13.4.3 Application

Varnish shall then be applied in very thin coats with a special fine-haired varnishing brush and not with an ordinary paintbrush. Unless otherwise specified, the best copal varnish, as described under Heading 13.4 of these specification for "Varnishes" shall be used. If more than one coat has been specified the first coat shall be rubbed with the fine sand paper. Other coats shall be applied as directed by the Engineer-incharge.

13.4.4 Measurement

Varnishing shall be measured by superficial area. The unit of measurement shall be 100 square feet or one square meter. Moulded work of all kinds, unless otherwise specified, shall be measured by running the tape over and into all elevations and depressions. In the case of other classes of work painted on both sides the flat area of the surface on one side, including glazing and chowkat, shall be multiplied by the factors given below to arrive at the correct measurement of both sides for the purpose of making payment.

a. Paneled or battened doors and windows	2 times
b. Glazed or partly glazed doors or windows	2 times
c. Plate glass windows (large glazed area)	1 time
d. Wire gauze doors or windows	1 time
e. Trellis work	2 times
f. Grated doors and windows and other grating	1 time
g. Palisade fencing	0.6 time

Note: In the case of chowkat having two rebates, one for wooden door and the other for wire gauze shutter, the surface area of the chowkat shall be included in the measurement of only one door.

13.4.5 Rates**13.4.5.1 Labor Rates**

The unit rate shall include the cost of preparing, cleaning, rubbing, knotting, stopping the surface and applying varnish on it as per above specifications. It shall also include the cost of providing, using and removing scaffoldings, supports, ladders shot with gunny bags at both ends, fine-haired special brushes for varnishing and any other tool or plant required for doing varnishing as per above specifications and removal of all defects from the varnished surface to leave it perfect in every respect. It shall further include the cost of all allied operations like the removal of stains, smears, splashes and droppings on the walls, floor, glazing, furniture and other places.

13.4.5.2 Composite Rates

The unit rate shall include the cost of supplying varnish of an approved quality and all other materials required for doing varnishing as per above specifications at site of works in addition to the labour rate as detailed in Heading 13.4.5.1.

13.5 French Polish

13.5.1 Description

This work shall cover French polishing of wooden surface in accordance with these specifications.

13.5.2 Preparation of Surface

Unless otherwise specified the wooden surface to be polished shall be prepared according to Heading 13.4 of these specifications for Varnishing.

13.5.3 Materials

- a. Pure chalk
- b. Powder linseed oil and bee wax 3:1 boiled
- c. Plaster of Paris paste in water or raw linseed oil.

13.5.4 Preparation for Wax Polishing

The bee's wax polish shall be prepared by mixing in two parts of bee's wax with two parts of boiled linseed oil over a slow fire. When it is dissolved, but is still warm, one part of turpentine shall be added.

13.5.5 Application

- a. After the surface has been prepared it shall be first coated with a filler composed of 5 lbs. of whiting mixed with $\frac{1}{3}$ rd. of a gallon of mentholated spirit and then rubbed with sand paper. A thin coat of polish shall then be applied. The surface shall then be rubbed with sand paper before the second and subsequent coats are applied.
- b. Alternatively, plaster of Paris, red ochre (sufficient to tint it), and linseed oil are mixed together to form a stiff paste which shall be applied sparingly and rubbed hard on the surface to till up the pores or the wood. Prior to this a piece of rag moistened with linseed oil shall be rubbed on the surface.

- c. The surface shall be rubbed smooth with fine glass paper a few hours later and then polished.
- d. Unless otherwise specified, two coats of French polish of an approved type shall be applied.
- e. To finish off, the surface shall be rubbed lightly and quickly with a circular motion by means of a piece of flannel rolled into the form of a rubber, covered with a place of rag slightly damped with methylated spirit. If the rag sticks, the surface shall be touched with linseed oil.

13.5.6 Measurement

It shall be measured by superficial area. The unit of measurement shall be 100 square feet or one square meter. Moulded work of all kinds, unless otherwise specified, shall be measured by running the tape over and into all elevations and depressions. In the case of other classes of work painted on both sides the flat area of the surface on one side, including glazing and chowkat, shall be multiplied by the factors given below to arrive at the correct measurement of both sides for the purpose of making payment.

a. Paneled or battened doors and windows	2 times
b. Glazed or partly glazed doors or windows	2 times
c. Plate glass windows (large glazed area)	1 time
d. Wire gauze doors or windows	1 time
e. Trellis work	2 times
f. Grated doors and windows and other grating	1 time
g. Palisade fencing	0.6 time

Note: In the case of chowkat having two rebates, one for wooden door and the other for wire gauze shutter, the surface area of the chowkat shall be included in the measurement of only one door.

13.5.7 Rate

13.5.7.1 Labor Rate

The unit rate shall include the cost of preparing, cleaning, rubbing, knotting, stopping the surface and applying varnish on it as per above specifications. It shall also include the cost of providing, using and removing scaffoldings, supports, ladders shot with gunny bags at both ends, fine-haired special brushes for varnishing and any other tool or plant required for doing varnishing as per above specifications and removal of all defects from the varnished surface to leave it perfect in every respect. It shall further include the cost of all allied operations like the removal of stains, smears, splashes and droppings on the walls, floor, glazing, furniture and other places.

13.5.7.2 Composite Rate

The unit rate shall include the cost of supplying varnish of an approved quality and all other materials required for doing varnishing as per above specifications at site of works in addition to the labour rate as detailed in Heading 13.5.7.1.

13.6 Wax Polishing

13.6.1 Description

This work shall cover wax polishing of wooden surface in accordance with these specifications. Wax polishing shall be done where a dull polish, which shall not destroy the natural colour and graining of teak or shisham.

13.6.2 Preparation of Surface

- a. New woodwork to be polished shall be finished smooth with the plane making sure that no plane marks are left after finishing.
- b. The surface shall be made perfectly smooth by rubbing it with sand paper or pumice stone.
- c. It shall then be stopped and rubbed perfectly smooth first with medium grained sand paper and then with fine sand paper. The final rubbing shall be done with sand paper which has been slightly moistened with linseed oil and rubbed for a few seconds.

13.6.3 Materials

- a. Bee's wax
- b. Linseed oil
- c. Turpentine

13.6.4 Preparation for Wax Polishing

The bee's wax polish shall be prepared by mixing two parts of bee's wax with two parts of boiled linseed oil over a slow fire. When it is dissolved, but is still warm, one part of turpentine shall be added.

13.6.5 Application

13.6.5.1 First Coat

Bee's wax polish as prepared above shall be applied with a clean cloth pad and rubbed continuously for at least half an hour.

13.6.5.2 Second Coat

When the surface is quite dry the second coat shall be applied in the same manner and rubbed continuously for an hour or till the surface has dried.

13.6.5.3 Final Coat

The final coat shall then be applied and rubbed for two hours (more if necessary) till the surface has assumed a uniform gloss and is quite dry, showing no signs of stickiness when touched. The final polish depends largely on the amount of rubbing which shall be done continuously with uniform pressure and with frequent change in direction.

13.6.6 Measurement

It shall be measured by superficial area. The unit of measurement shall be 100 square feet or one square meter. Moulded work of all kinds, unless otherwise specified, shall be measured

by running the tape over and into all elevations and depressions. In the case of other classes of work painted on both sides the flat area of the surface on one side, including glazing and chowkat, shall be multiplied by the factors given below to arrive at the correct measurement of both sides for the purpose of making payment.

a. Paneled or battened doors and windows	2 times
b. Glazed or partly glazed doors or windows	2 times
c. Plate glass windows (large glazed area)	1 time
d. Wire gauze doors or windows	1 time
e. Trellis work	2 times
f. Grated doors and windows and other grating	1 time
g. Palisade fencing	0.6 time

Note: In the case of chowkat having two rebates, one for wooden door and the other for wire gauze shutter, the surface area of the chowkat shall be included in the measurement of only one door.

13.6.7 Rate

13.6.7.1 Labor Rate

The unit rate shall include the cost of preparing, cleaning, rubbing, knotting, stopping the surface and applying varnish on it as per above specifications. It shall also include the cost of providing, using and removing scaffoldings, supports, ladders shot with gunny bags at both ends, fine-haired special brushes for varnishing and any other tool or plant required for doing varnishing as per above specifications and removal of all defects from the varnished surface to leave it perfect in every respect. It shall further include the cost of all allied operations like the removal of stains, smears, splashes and droppings on the walls, floor, glazing, furniture and other places.

13.6.7.2 Composite Rate

The unit rate shall include the cost of supplying varnish of an approved quality and all other materials required for doing varnishing as per above specifications at site of works in addition to the labour rate as detailed in Heading 13.6.7.1.

13.7 Oiling Wood Works

One lb. of bee's was is mixed with 3 lbs. of double boiled linseed oil and heated over a slow fire till it melts. It is allowed to cool and then 1-lb of turpentine is added to it. This will cover about 800 ft² of wooden surface. The wood work can also be oiled with country's sweet oil to which equal part of vinegar and turpentine have been added. This gives a darker effect. The mixture of oil and water should never be uses.

13.7.1 Scope

Wood work not exposed to weather shall be oiled with linseed oil or sweet oil preparations as specified.

13.7.2 Linseed Oil Preparations

One lb. of bee's wax shall be mixed with 3 lbs. of boiled linseed oil and heated over a slow fire till the wax is melted. After the mixture has cooled, one lb. of turpentine oil shall be added.

13.7.3 Oiling

The specified oil preparation shall be up after cleaning and allowed to soak in.

13.8 Painting Wood Work with solignum or creosote or Coal Tar.

13.8.1 Quality

Solignum, creosote or tar, whichever has been specified, shall be of an approved quality.

13.8.2 Heating and Preparation

- a. Before applying, solignum/creosote/tar shall be heated to just short of boiling.
- b. If tar is specified it shall be thinned with kerosene oil or common country spirit in the following proportions:
4 parts tar to 1-part kerosene, or 1-gallon tar to ½ pint country spirit:
2 lbs. unslaked lime shall be mixed with 1-gallon of tar to prevent his running.
The mixture shall then be heated to a near boiling point.
- c. It shall be then applied with a stiff flat brush or a spraying machine as specified.
- d. The paint shall be stirred occasionally while it is being applied.
- e. The ends of the timber pieces shall be liberally coated and, where possible, dipped in the hot solignum or creosote.
- f. Where more than one coat has to be applied, subsequent coats shall be applied when the previous one has dried.

13.8.3 Other Respects

In respect of measurement and rates it shall conform to Specifications for Painting (General).

13.8.4 Measurements

It shall be measured by superficial area. The unit of measurement shall be 100 square feet or one square meter. Moulded work of all kinds, unless otherwise specified, shall be measured by running the tape over and into all elevations and depressions. In the case of other classes of work painted on both sides the flat area of the surface on one side, including glazing and chowkat, shall be multiplied by the factors given below to arrive at the correct measurement of both sides for the purpose of making payment.

- a. Paneled or battened doors and windows 2 times
- b. Glazed or partly glazed doors or windows 2 times
- c. Plate glass windows (large glazed area) 1 time
- d. Wire gauze doors or windows 1 time
- e. Trellis work 2 times
- f. Grated doors and windows and other grating 1 time
- g. Palisade fencing 0.6 time

Note: In the case of chowkat having two rebates, one for wooden door and the other for wire gauze shutter, the surface area of the chowkat shall be included in the measurement of only one door.

13.8.5 Rates

13.8.5.1 Labor Rate

The unit rate shall include the cost of preparing, cleaning, rubbing, knotting, stopping the surface and applying varnish on it as per above specifications. It shall also include the cost of providing, using and removing scaffoldings, supports, ladders shot with gunny bags at both ends, fine-haired special brushes for varnishing and any other tool or plant required for doing varnishing as per above specifications and removal of all defects from the varnished surface to leave it perfect in every respect. It shall further include the cost of all allied operations like the removal of stains, smears, splashes and droppings on the walls, floor, glazing, furniture and other places.

13.8.5.2 Composite Rate

The unit rate shall include the cost of supplying varnish of an approved quality and all other materials required for doing varnishing as per above specifications at site of works in addition to the labour rate as detailed in Heading 13.8.5.1.

13.9 Painting Iron Work above water

13.9.1 Weather

- a. Painting of iron work shall not be done in damp, wet, stormy or extremely hot weather.
- b. Too quick drying in the baking of heat of a summer sun shall also be avoided.

13.9.2 Preparation of Surface and Application of Paint

- a. If the iron has not been painted previously it shall be thoroughly cleaned of all rust and scale by means of steel scrapers, chisels, or steel wire brushes till the bright shining surface of the iron appears.
- b. The surface shall then be cleaned with dry cotton waste and the paint applied immediately.
- c. Each small patch shall be painted as soon as cleaned if the painting is being done in damp weather since iron begins to rust within a few minutes after it has been cleaned.
- d. In repainting iron work whose old paint is sound, the surface shall be rubbed with wire brushes and scrapers and all the loose paint that comes away shall be taken off. If the paint is in a bad condition it shall be burnt off with a blow lamp or by other means as specified.
- e. If it is necessary to paint galvanized iron; a coat composed of eight ounces of copper acetate added to a gallon of water shall be applied first, this being paid for separately. Unless otherwise specified, the first coat of paint shall be composed of genuine red lead mixed with raw linseed oil and turpentine in equal proportion.
- f. Second and subsequent coats shall be applied more, uniformly with the paint brush in long strokes evenly drawn or with a spraying machine as specified.

- g. Sufficient time shall be allowed between the coats to allow the paint to dry up. Unless otherwise specified, an interval of 24 hours shall be sufficient.

13.9.3 Number of Coats

- a. On new work, three coats shall be applied but on old work it is sufficient to have two coats only.
- b. Each coat shall preferably vary slightly from the preceding one in shade, in-order to ascertain that full numbers of coats have actually been applied.

13.9.4 Paints

The paint used shall be of an approved quality.

13.9.5 Measurements

Painting and varnishing shall be measured by superficial area. The unit of measurement shall be 100 square feet or one square meter. Moulded work of all kinds, unless otherwise specified, shall be measured by running the tape over and into all elevations and depressions. In the case of other classes of work painted on both sides the flat area of the surface on one side, including glazing and chowkats, shall be multiplied by the factors given below to arrive at the correct measurement of both sides for the purpose of making payment.

- | | |
|-----------------------------------------------|----------|
| a. Paneled or battened doors and windows | 2 times |
| b. Glazed or partly glazed doors or windows | 2 times |
| c. Plate glass windows (large glazed area) | 1 time |
| d. Wire gauze doors or windows | 1 time |
| e. Trellis work | 2 times |
| f. Grated doors and windows and other grating | 1 time |
| g. Palisade fencing | 0.6 time |

Note: In the case of chowkats having two rebates, one for wooden door and the other for wire gauze shutter, the surface area of the chowkats shall be included in the measurement of only one door.

13.9.6 Rates

13.9.6.1 Labor Rate

The unit rate shall include the cost of cleaning, preparing and painting the surface according to the above specifications or any other specifications specially included in the contract. It shall further include the cost of providing, using and removing scaffoldings, supports, ladders, shot with gunny bags at both ends, brushes or spraying machines of approved type and any other tool or plant required for doing painting as per above specifications and removal with turpentine or other approved methods of all defects from the painted surface to leave it perfect in every respect. It shall further include the cost of all allied operations like the removal of stains, smears, splashes and droppings on the walls, floors, glazing, furniture and other places.

13.9.6.2 Composite Rate

The unit rate shall include the cost of supplying paints of approved quality, paint remover in case of painting old work and all other material required for doing painting as per above specifications at site of work in addition to the labour rate as detailed in Heading 13.9.6.1.

13.10 Painting Iron Work Which Remains Under Water

13.10.1 Preparation of Surface and Application of Paints

- a. Unless otherwise specified, the surface shall be prepared according to Specifications for Painting Iron Work above Water.
- b. The paint shall be applied hot as soon as the surface is cleaned.
- c. Subsequent coats shall be applied only after the previous one has dried.

13.10.2 Painting Material

Unless otherwise specified, khanki mixture prepared in the manner as described in heading 9.1.5.2 of Chapter-9 of Book-1 (Specification for Engineering Material), or any other approved paint shall be used.

13.10.3 Number of Coats

Two to three coats actually specified shall be given.

13.10.4 Protection

Work thus painted shall not be immersed in water until it has dried up; one week shall be generally sufficient for this purpose depending upon the weather.

13.10.5 Other Respects

In all other respects not specified here it shall conform to 9.1.5.1 Chapter-9 of Book-1 (Specification for Engineering Material) for Painting Iron Work above Water.

13.10.6 Measurement

It shall be measured by superficial area. The unit of measurement shall be 100 square feet or one square meter. Moulded work of all kinds, unless otherwise specified, shall be measured by running the tape over and into all elevations and depressions. In the case of other classes of work painted on both sides the flat area of the surface on one side, including glazing and chowkat, shall be multiplied by the factors given below to arrive at the correct measurement of both sides for the purpose of making payment.

- a. Paneled or battened doors and windows 2 times
- b. Glazed or partly glazed doors or windows 2 times
- c. Plate glass windows (large glazed area) 1 time
- d. Wire gauze doors or windows 1 time
- e. Trellis work 2 times
- f. Grated doors and windows and other grating 1 time
- g. Palisade fencing 0.6 time

Note: In the case of chowkats having two rebates, one for wooden door and the other for wire gauze shutter, the surface area of the chowkats shall be included in the measurement of only one door.

13.10.7 Rates

13.10.7.1 Labor Rate

The unit rate shall include the cost of preparing, cleaning, rubbing, knotting, stopping the surface and applying varnish on it as per above specifications. It shall also include the cost of providing, using and removing scaffoldings, supports, ladders shot with gunny bags at both ends, fine-haired special brushes for varnishing and any other tool or plant required for doing varnishing as per above specifications and removal of all defects from the varnished surface to leave it perfect in every respect. It shall further include the cost of all allied operations like the removal of stains, smears, splashes and droppings on the walls, floor, glazing, furniture and other places.

13.10.7.2 Composite Rate

The unit rate shall include the cost of supplying varnish of an approved quality and all other materials required for doing varnishing as per above specifications at site of works in addition to the labour rate as detailed in Heading 13.10.7.1.

13.11 Coal Tarring Iron Work

13.11.1 Preparation of Surface

- a. The surface to be coal-tarred shall be cleaned off all dust, rust, scale and grease, etc.
- b. It shall be dry and clean.

13.11.2 Heating and Preparing Tar

To each gallon of tar 2 lbs. of unslaked lime shall be added and the mixture heated till it begins to boil. Then it shall be taken off the fire and kerosene oil added to it slowly in the proportion of 1 part of kerosene to 4 parts of tar.

13.11.3 Application

- a. Tar shall be applied as hot as possible with a brush. On no account rags shall be used for applying tar.
- b. Where possible, the article to be tarred shall be dipped in the hot tar.

13.12 Painting Plaster/concrete surfaces

13.12.1 General

- a. Unless otherwise specified or directed in writing by the Engineer-in-charge, a plastered wall shall not be painted till 3 months have elapsed since plastering work was completed.
- b. In the absence of special primers and wall paint, the plastered surfaces shall be prepared and painted as specified below.

13.12.2 Preparation of Surface

- a. All loose and linking material shall be removed from old walls by scraping or wire brushing and the surface shall be carefully smoothed and cleared.
- b. All dust, dirt, oil, grease or efflorescence shall be carefully removed.
- c. To ensure a uniform appearance to the finished work and to make a lime plastered surface non-absorbent, the surface, if not previously whitewashed, shall be painted with acrylic wall coating or glue size or otherwise, with boiled linseed oil and thin size, tinged with red lead.

13.12.3 Priming Coat

- a. Having prepared the surface, a priming coat composed of equal parts of white and red lead mixed in boiled linseed oil to the desired consistency, shall be applied.
- b. When the priming coat dries up, all cracks, holes and such other defects shall be filled up with a mixture of 1-part white lead and 3 parts ordinary putty.
- c. The surface shall then be rubbed with pumice stone or sand paper and dusted clean.

13.12.4 Second and Third Coats

- a. Second coat shall consist of white lead and boiled linseed oil.
- b. Third coat shall consist of white lead tinted to approach the desired colour and mixed with raw linseed oil as a carrier and a small proportion of turpentine as drier.

13.12.5 Fourth or Finishing Coat

The finishing coat shall contain a large proportion of turpentine with a little varnish to serve as a binder and applied when the previous coat is still sticky and shall be evenly stippled over the surface with a stippling brush, so as to dry flat with a velvet-like surface.

13.12.6 Treatment of Newly Cement Plastered Surface

- a. In case it has been specified or directed in writing by the Engineer-in-charge to paint a newly cement plastered surface without waiting for specified period, a solution of 5 lbs. of zinc sulphate dissolved in a gallon of water, shall be applied to the surface and when it dries up, a coat of pure raw linseed oil shall be given.
- b. Alternatively, the surface shall be treated with dilute sulphuric or hydrochloric acid (one-part acid to 50 parts water) and then washed down with water.
- c. Neither of these two treatments is included in the rate and shall be paid separately.

13.12.6.1 Prime and Second Coats

Unless otherwise specified or directed in writing by the Engineer-in-charge and in the absence of a special cement paint being specified, after treating the surface, two coats of paint thinned with turpentine and having a little varnish as binder, shall be applied.

13.12.6.2 Third Coat

The third coat of paint shall be thinned with a mixture of three parts of boiled linseed oil to one part of turpentine.

13.12.6.3 Fourth or Final Coat

The fourth and finishing coat shall be give as specified for lime plaster. The finishing coat of plasterer's putty prepared as above shall be applied on the floated coat after it has set. The floated coat shall be finished according to specifications for single coat or double coat, as the case may be. The thickness of this coat shall be $\frac{1}{8}$ th. of an inch unless otherwise specified. The surface shall be rubbed smooth with a steel plasterer's trowel to give it a polished surface.

13.12.7 Measurements

The plaster shall be measured by the surface area. The unit of measurement shall be 100 square feet.

13.12.8 Rate

13.12.8.1 Labour Rate

The unit rate shall include the cost of cleaning, preparing and painting the surface according to the above specifications or any other specifications specially included in the contract. It shall further include the cost of providing, using and removing scaffoldings, supports, ladders, shot with gunny bags at both ends, brushes or spraying machines of approved type and any other tool or plant required for doing painting as per above specifications and removal with turpentine or other approved methods of all defects from the painted surface to leave it perfect in every respect. It shall further include the cost of all allied operations like the removal of stains, smears, splashes and droppings on the walls, floors, glazing, furniture and other places.

13.12.8.2 Composite Rate

The unit rate shall include the cost of supplying paints of approved quality, paint remover in case of painting old work and all other material required for doing painting as per above specifications at site of work in addition to the labour rate as detailed in Heading 13.14.8.1.

13.13 Painting with Synthetic Enamel Paint

Synthetic Enamel Paint of approved brand and manufacture and of the required colour shall be used for the top coat and an undercoat of ordinary Paint of shade to match the top coat as recommended by the same manufacturer as far the top coat shall be used.

13.13.1 Painting on New Surface

Preparation of surface shall be as specified in 13.3 as the case may be.

13.13.1.1 Application

The number of coats including the undercoat shall be as stipulated in the item.

- Under Coat: One coat of the specified ordinary Paint of shade suited to the shade of the top coat, shall be applied and allowed to dry overnight. It shall be rubbed next day with the finest grade of wet abrasive paper to ensure a smooth and even surface, free from brush marks and all loose particles dusted off.

- Top Coat: Top coats of synthetic enamel Paint of desired shade shall be applied after the undercoat is thoroughly dry. Additional finishing coats shall be applied if found necessary to ensure properly uniform glossy surface.

13.13.2 Painting on Old Surface

13.13.2.1 Preparation of Surface

Where the existing Paint is firm and sound it shall be cleaned of grease, smoke etc. and rubbed with sand paper to remove all loose particles dusted off. All patches and cracks shall then be treated with stopping and filler prepared with the specified Paint. The surface shall again be rubbed and made smooth and uniform. If the old paint is blistered and flaked it will be necessary to completely remove the same. Such removal shall be paid for separately and the painting shall be treated as on new surface.

13.13.2.2 Painting

The number of coats as stipulated in the item shall be applied with synthetic enamel Paint. Each coat shall be allowed to dry and rubbed down smooth with very fine wet abrasive paper, to get an even glossy surface. If, however, the surface is not satisfactory additional coats as required shall be applied to get correct finish.

13.13.3 Measurements

The length and breadth shall be measured correct to a cm. The area shall be calculated in sqm (correct to two places of decimal), except otherwise stated. Small articles not exceeding 10 sq. decimeter (0.1 sqm) of painted surfaces where not in conjunction with similar painted work shall be enumerated.

Note: Components of trusses, compound girders, stanchions, lattices and similar work shall, however, be given in sq. meters irrespective of the size or girth of members. Priming coat of painting shall be included in the work of fabrication.

13.14 Weather shield Paint.

Contractor should follow the specification of heading 13.1 of this chapter.

13.14.1 Material

Weather shield paint of approved quality

13.14.2 Construction Requirements

1. Apply 3-4 coats of Weathershield and leave for 2-3 hours between coats.
2. Tentatively one litre paint will be enough for 155 sft area but at site engineer in charge will be responsible for deciding the quantity of paint to be used.
3. Only as much material should be mixed as can be used up in one hour.

13.14.3 Measurement & Payment

Paint work shall be measured in square feet unit and will be paid accordingly. Payment shall be inclusive of material and labor cost. Not extra payment should be made in account of replacement of substandard work.

Table of Contents

14	PLUMBING, SANITARY INSTALLATIONS & GAS FITTINGS	4
14.1	Scope	4
14.2	References	4
14.2.1	BS (British Standards)	4
14.2.2	ASTM (American Society for Testing Materials)	4
14.2.3	ASSE (American Society of Safety Engineers)	5
14.2.4	ISO (International Standards Organisation)	5
14.3	Definitions	5
14.3.1	Domestic Waste Water	5
14.3.2	Sanitary pipe work	5
14.3.3	Branch discharge pipe	5
14.3.4	Discharge stack	5
14.3.5	Stack vent	5
14.3.6	Air admittance valve	5
14.3.7	Floor gully	5
14.3.8	Trap	6
14.3.9	Depth of water seal	6
14.4	Submittals/Samples	6
14.5	Quality Assurance, Inspection and Testing	7
14.5.1	Inspection	7
14.5.2	Air Pressure Test	7
14.5.3	Smoke Test	7
14.5.4	Syphonage Test	7
14.5.5	Tests for Underground drain pipes	7
14.5.6	Inspection and Testing	8
14.5.7	Water Mains	8
14.5.8	Cold Water Systems	8
14.5.9	Hot Water systems	9
14.5.10	Sterilization of Cold Water Systems	9
14.6	Material Requirements	10

14.6.1	Cast Iron Pipes & Fittings	10
14.6.2	Galvanized Iron Pipes and Fittings	10
14.6.3	Plastic Pipes and Fittings	10
14.6.4	MILD STEEL (MS) PIPES	10
14.7	Plumbing and Sanitary Fixtures	11
14.7.1	Water Closet	11
14.7.2	Seat	12
14.7.3	Flushing Cistern	12
14.7.4	Wash Hand Basin	14
14.7.5	Waste Pipe	15
14.7.6	CP (chromium plated) Soap Dish	15
14.7.7	CP (chromium plated) Toilet Paper Holder	16
14.7.8	CP (chromium plated) Towel Rail	16
14.7.9	Mirror	17
14.7.10	Tooth Brush Holder with Tooth Paste Dish	17
14.7.11	Plate Glass Shelves with CP Guard Rails	18
14.7.12	C.P. (chromium plated) Hanger	18
14.7.13	One Hole Mixer	18
14.7.14	CP Shower and CP Arms	19
14.7.15	Urinals	19
14.7.16	Sink	20
14.7.17	Bath Tubs	20
14.7.18	Taps and Stop Cocks	22
14.7.19	Floor Traps	22
14.7.20	Gully Traps	23
14.7.21	Valves (Air relief valves, non-return valves, gate valves; etc.)	23
14.7.22	Manhole Cover and Frame	24
14.8	Construction Requirements	24
14.8.1	Laying of Building Sewers/Soil pipes	24
14.8.2	Drainage Piping Installation	24
14.8.3	Pipe Joints	25

14.8.4	Connection between Drainage Piping and Fittings	25
14.8.5	Prohibited Joints and Accessories	26
14.8.6	Cleanout Plugs	26
14.8.7	Water Closets (WCs)	27
14.8.8	Traps	27
14.8.9	Gullies	28
14.8.10	Access to Drains	28
14.8.11	Interceptors and Separators	28
14.8.12	Vents	29
14.8.13	Air Admittance Valves	29
14.8.14	Measurement and Payment	30

PLUMBING, SANITARY INSTALLATIONS & GAS FITTINGS

14.1 Scope

This chapter provides specifications for providing and installing pipelines and sanitary appliances for the “Water supply”, “collection and discharge of waste water” and for installation of Gas fittings inside the building premises. The materials used for the manufacture of sanitary appliances and fittings are to be durable, impervious, corrosion resistant with smooth surface that can easily be cleaned in accordance with these specifications and/or as directed by the Engineer.

14.2 References

14.2.1 BS (British Standards)

- BS EN 12056-2 Gravity drainage systems inside buildings. Sanitary pipe work, layout and calculation
- BS EN 12056-3 Gravity drainage systems inside buildings. Roof Drainage, layout and calculation

14.2.2 ASTM (American Society for Testing Materials)

- ASTM A 74 Standard Specification for Cast Iron Soil Pipe and Fittings
- ASTM C 564 Standard Specification for Rubber Gaskets for Cast Iron Soil Pipe and Fittings
- ASTM C 1440 Standard Specification for Thermoplastic Elastomeric (TPE) Gasket Materials for Drain, Waste and Vent (DWV), Sewer, Sanitary and Storm Plumbing Systems
- ASTM D 2564 Standard Specification for Solvent Cements for Polyvinyl Chloride Plastic Piping Systems
- ASTM D 2855 Standard Practice for Making Solvent-Cemented Joints with Poly Vinyl Chloride (PVC) Pipe and Fittings
- ASTM F 656 Standard Specification for Primers for Use in Solvent Cement Joints of Poly Vinyl Chloride (PVC) Plastic Pipe and Fittings
- ASTM F 477 Standard Specification for Elastomeric Seals (Gaskets) for Joining Plastic Pipe

14.2.3 ASSE (American Society of Safety Engineers)

ASSE 1050	Performance Requirements for Stack Air Admittance Valves for Sanitary Drainage Systems
ASSE 1051	Air Admittance Valves for Plumbing Drainage Systems – Fixture and Branch Devices

14.2.4 ISO (International Standards Organisation)

ISO: 391: 1982	Specifications for crystalline cement pipes for buildings
ISO: 392:1986.	Specifications for crystalline cement pipes

14.3 Definitions

14.3.1 Domestic Waste Water

Water which is contaminated by use and normally discharged from water closet, showers, baths, bidets, wash basins, sinks and floor gullies.

14.3.2 Sanitary pipe work

Arrangement of discharge pipes and fittings, with or without ventilating pipes, connected to a drainage system.

14.3.3 Branch discharge pipe

Pipe connecting sanitary appliances to a discharge stack or drain.

14.3.4 Discharge stack

Main (generally vertical) pipe, conveying discharges from sanitary appliances.

14.3.5 Stack vent

Extension of a vertical discharge pipe above the highest branch discharge pipe connection that terminates in an end, open to the atmosphere.

14.3.6 Air admittance valve

Valve that allows air to enter the system but not to escape in order to limit pressure fluctuations within the sanitary pipe work.

14.3.7 Floor gully

Discharge fitting intended to receive water from floors either through apertures in a

grating or from pipes connected to the body of the gully. A gully may include a trap.

14.3.8 Trap

Device that prevents the passage of foul air by means of water seal.

14.3.9 Depth of water seal

The depth of water which would have to be removed from a fully charged trap before gases and odours at atmospheric pressure could pass through the trap.

14.4 Submittals/Samples

The contractor shall provide manufacturers specifications for all items to be supplied under this part.

The contractor shall provide shop drawings for the installation of piping, fittings, floor gullies, traps, floor cleanouts, grease removal unit etc. including all items listed in the project documentation.

Prior to commencement of works on site Contractor shall submit shop drawings for approval to the Engineer. All drawings shall have plans and sections and shall have sufficient details to clearly reflect the installation of the system. All material specifications shall be provided on the drawings. All information required for preparing suitable foundation, for providing suitable access to the system, for making openings in building structure, for coordination with electrical, air-conditioning and other designs etc., shall be clearly provided.

Approval by the Engineer in Charge of the shop drawing for any material, apparatuses, devices and layout, shall not relieve the Contractor from the responsibility of furnishing same of proper dimensions, size, quantity and all performance characteristic to efficiently perform the requirements and intent of the Contract of the Document. Such approval shall not relieve the Contractor from the responsibility for errors of any sort in the shop drawing.

The contractor shall prepare a detailed testing and inspection programme, including method statements, and submit it to the Engineer for approval. This programme shall identify each item to be tested, the type of test to be performed and the date and time of the test.

The contractor shall prepare test record sheets for all tests undertaken. The format of the test record sheet shall be to the approval of the Engineer. On successful completion of a test, the test record sheet shall be signed and stamped by all parties. The Engineer shall retain the original test record sheet.

The submittal shall include catalogue pages, erection descriptions and manufacturer's data.

14.5 Quality Assurance, Inspection and Testing

Inspection and testing of sanitary drainage system shall be carried out as follows:

14.5.1 Inspection

During installation, regular inspections shall be made to check compliance with specifications and standards. Particular attention shall be given to quality of jointing, security of brackets and removal of swarf, cement or rubble from inside pipe runs.

14.5.2 Air Pressure Test

All the pipes and fittings shall be factory tested before delivery to the site. The complete system shall be tested on completion by filling the water seals and inserting air bags, expandable bungs, into the ends of stack pipes. A rubber hose will be inserted into the vent stack through a WC water trap. The air pressure in the stack will be hand-pumped up to 38 mm water gauge, measured on a U-tube manometer. This pressure must remain constant for 3 min. without further pumping. Soap solution wiped onto joints will reveal leak locations.

14.5.3 Smoke Test

Existing stacks shall be tested by the injection of smoke from oil-burning generator or a smoke cartridge, provided that it will not cause damage to the drain materials. Suitable warnings must be given to the occupants of the building.

14.5.4 Syphonage Test

The simultaneous discharge of several appliances shall reveal a minimum remaining water seal of 25 mm in all traps. Discharge should take place quietly and smoothly.

14.5.5 Tests for Underground drain pipes

14.5.5.1 Water Test

Water tests shall be carried out before and sometimes after backfilling. Drain runs shall be tested between manholes. The lower end shall be sealed with an expandable plug. A temporary up stand plastic or aluminium pipe shall be connected at the higher manhole. Water shall be admitted to produce a static head of 1.4 to 2.4 m and shall be maintained for an hour or more. The maximum allowable water loss is 1.0 litre/hr. for 10 m length of 100 mm diameter pipe or pro rata for other diameters and lengths.

14.5.5.2 Air Test

A static pressure of 75 mm water gauge on a U-tube manometer should be maintained for a period of 5 min. without further pumping.

14.5.6 Inspection and Testing

Manholes shall be inspected and tested for water tightness or damage prior to placing into service.

14.5.7 Water Mains

- i) The water main shall be tested in sections as the work of laying proceeds and joints left expose for the inspection during testing. After completion of each section, the main shall be carefully and mainly charged with water so that all air is expelled, allowed to sand full of water for 1-2 days if possible, and then tested under pressure. The test pressure shall be 90M head or the maximum working pressure plus 50%, whichever is greater.
- ii) The pressure shall be applied by means of a manually operated test pumps, or in case of long mains or mains of large diameter, by a power-driven test pump provide and that the pump not left unattended. Precaution must always be taken to see that test pressure is not exceeded above the limit. Pressure gauges must be accurate and if necessary shall be re-calibrated before the test.
- iii) After the pump has been stopped, the test pressure shall be maintained as long as is necessary to inspect the whole of the pipe work under test not less than half-an-hour before the operation of any event. Open ends of mains shall be temporarily close for testing by making it fitting water light with plugs. The end of the main and any test plug must be well secured to resist the end thrust of the water pressure in the main. (I.e. maximum test pressure times the cross sectional area of the pipe) if the section of main terminates with a sluice valve; and the wedge of the valve shall never be used to retain the water since this might lead to permanent distortion of the working parts of the valve. Instead, the valve shall be fitted with a blank flange or socket plug and the valve left in the open position whilst testing. End support shall be provided as explained previously.

14.5.8 Cold Water Systems

- i) When the installations are complete they shall be slowly and carefully charged with water, allowing all air to escape thus avoiding shock or water hammer. The system shall be inspected under working conditions of pressure and flow when all draw-off and taps are closed; and shall be absolutely watertight. Each draw-off tap shall be opened and tested for rate of flow of certain specifying

authorities may require pressure testing of internal pipe work, in which case, systems shall be tested in accordance with the pressure test previously described. In such cases it may be necessary to isolate items of equipment from the pressure test if they are not capable of withstanding the test pressure. Where these items are removed, blanking flanges or plugs must be used or a make-up piece of pipe work installed temporarily.

- ii) All piping, flitting and appliances shall be inspected and checked for satisfactory support and protection from physical damage corrosion and frost.
- iii) Because of the possibility of damage in transit, it is always advisable to retest cisterns, tanks and cylinders for water tightness on arrival at site and before fixing.

14.5.9 Hot Water systems

- i) Hot water systems shall be thoroughly flushed out and tested in the same manner as described for cold water systems. Where thermal insulation is used. The hydraulic test shall be made before the insulation work is completed and whilst, all joints are exposed.
- ii) Where a pressure is employed, boiler and clarifier relief valves shall be removed and tested lately. The test pressure shall be one and half times the normal working pressure and this shall be maintained for thirty minutes after making good any leak.
- iii) It is necessary to carry out the hydraulic pressure test on sections of pipe work prior completion of the whole installation where these are fixed in ducts, chassis, trenches, etc. and are connected from view. If rectification of faulty materials of workmanship on such sections is likely to involve disturbance to finished structural features, the test pressure shall be twice the normal working pressure.

14.5.10 Sterilization of Cold Water Systems

- i) The whole of the system shall be sterilized to eliminate possible traces of bacteria.
- ii) Sterilization of public water mains carried out by the Water Authority who may also carry out the sterilization of new private means. Where this is not a standard practice, the plumbing contractor shall carry out the sterilization process as described below.
 - After cleaning the cistern of all debris, the cistern and pipe work shall be filled with water and the whole thoroughly flushed out. The system shall be then be filled with water a second time, but as the cistern is filling,

sterilizing chemical containing chlorine shall be added to ensure through mixing of the chemical and water. The dose shall be such as to give 50 parts of chlorine to one million parts of water. If ordinary bleaching powder is used, the proportion shall be 150g of powder to 1000 liters of water, the powder first being mixed with water to creamy consistency before being added. Proprietary brands of sterilizing chemicals shall be added in the proportions as instructed by the manufactures.

- After filling the system, the incoming water supply shall be shut-off and each tap on the distributing pipes opened successively, starting with that nearest the cistern. As the water which issues from each tap begins to smell of chlorine, the tap shall be closed. The cistern shall then be filled again to water-line with water to which has been added the correct dose of chemical.
- The whole system shall be allowed to stand charged with treated water for a period of at least three (3) hours, after which a test shall be made by smell for residual chlorine. If none is found, the sterilization shall be repeated.
- Before any water is used for domestic purposes, the whole system must be emptied and thoroughly flushed out with clean water.

14.6 Material Requirements

For fixing sanitary appliances in buildings, cast iron soil pipes, galvanized iron pipes, plastic pipes, asbestos/chrysotile cement pipes and allied fittings are generally being used for plumbing works.

14.6.1 Cast Iron Pipes & Fittings

Conforming to the specifications in relevant sub-section 14.1 of Book I.

14.6.2 Galvanized Iron Pipes and Fittings

Conforming to the specifications in relevant sub-section 14.2 of Book I.

14.6.3 Plastic Pipes and Fittings

Un-plasticized Polyvinyl Chloride (UPVC), Polyethylene (PE) / High Density Polyethylene (HDPE) and Polypropylene (PP) / Polypropylene Random (PPR) pipes and fittings conforming to the specifications in relevant sub-section 14.4 of Book I.

14.6.4 MILD STEEL (MS) PIPES

Conforming to the specifications in relevant sub-section 14.3 of Book I.

14.7 Plumbing and Sanitary Fixtures

Specifications and quality requirements of different plumbing and sanitary fixtures are described in the following paragraphs.

14.7.1 Water Closet

A water closet consists of a pan, a seat and a flushing cistern. It is made as ceramic ware in one piece of any material which is durable, impervious and corrosion resistant.

14.7.1.1 Source

Unless otherwise specified the water closet shall be of best quality manufactured in Pakistan and approved by the Engineer

14.7.1.2 Composition

The water closet shall be made of ceramic ware in one piece of material.

14.7.1.3 Quality

Each water closet shall show good workmanship without dents or faults. The surface and colour shall be uniform, non-corrodible, free from discoloration and imperfections.

14.7.1.4 Colour

The colour of the water closet shall be white or as approved.

14.7.1.5 Type

Type of the shall be Asian / European as specified in the drawings or as approved.

14.7.1.6 Size

The size of the water closet shall be as specified in the drawings or as approved.

14.7.1.7 Trap

The trap shall be either S or P type as approved. For manufacture and quality it shall conform to the specifications for water closet. Each trap shall have a circular opening of 0.02 meter (4") internal diameter for connection of anti-syphonage pipe.

14.7.1.8 Foot Rest

For squatting/Asiatic pattern type water closet the foot rest shall be an integral part of the water closet.

14.7.2 Seat

14.7.2.1 Source

Unless otherwise specified the seat shall be in double seat cover comprising a seat and a cover hinged together of best quality manufactured in Pakistan or as approved.

14.7.2.2 Composition

Seat shall be as per manufacturer's Standard.

14.7.2.3 Quality

Seat shall be made in one piece. It shall be free from blisters. The surface shall be highly polished impervious and hygienic.

14.7.2.4 Type

Seat shall be of closed or open pattern as per manufacturer's Standard.

14.7.2.5 Shape

The shape of the seat shall be in conformity with the type of water closet specified. The underside of the seat shall be flat and shall not be recessed. For closed pattern seat the hinging devices shall be either of good quality non-ferrous metal or any other corrosion resistant material.

14.7.2.6 Bolts

The bolts shall be of non-ferrous material 65 mm (2-1/2") in length. Two bolts shall be provided with each seat.

14.7.2.7 Buffers

Seat shall be provided with rubber buffers of 25mm x 37mm (1" x 1-1/2") size and 9.5 mm x 3/8") thickness. The buffers shall be rigidly attached to the seat. The metal in contact with buffers shall be non-ferrous. The cover of the seat for closed pattern shall have buffers not less than two in number.

14.7.2.8 Colour

The colour of the seat shall be black or as approved.

14.7.3 Flushing Cistern

Flushing cisterns are made from materials which are non-corrugible or protected against corrosion. These are either high level or low level type. The materials generally used for the manufacture of high level type are cast iron or pressed steel. The low level type is usually manufactured from materials as are used for pan and have the same colours. The cistern has a capacity of 2.5 to 3 gallons.

14.7.3.1 Source

Cistern shall be obtained from approved source which shall be of the best quality manufactured in Pakistan or as approved.

14.7.3.2 Composition

Low level non completed coupled cistern shall be made of ceramic ware in one piece of materials. For manufacture and quality it shall conform to Specifications of water closet.

14.7.3.3 Capacity

The capacity of the cistern shall be 13.5 litres (3 Gallons).

14.7.3.4 Quality

Each cistern shall show good workmanship without dents or faults. The surface and colour shall be uniform free from discoloration and imperfections.

14.7.3.5 Brackets / Bolt Kit

Brackets shall be of material as approved. The length of the bracket shall be such as to enable 100mm (4") embedding in the wall or fixed to the wall with the help of screws. Where bolt kit is available as standard accessory it shall conform to manufacturers specifications.

14.7.3.6 Cover

For composition and quality the cistern cover shall conform to the corresponding specification of cistern.

14.7.3.7 Flush Pipe

Flush pipe shall be of 31mm (1-1/2") internal diameter. It shall be manufactured either from steel or non-ferrous materials as approved.

The flush pipe shall be stainless steel as approved. Moulded rubber cone shall be provided for connection with the water closet.

14.7.3.8 Ball Valve and Component Parts

Ball valve and its component parts shall be either of brass or gun metal or any corrosion resistant alloy or plastic. These shall be sound, hard, smooth and well finished. The mechanism of component parts shall be such that when the position is in contact with the face of seat the short arm of the level shall be in vertical position. Ball valve shall not leak when tested to a pressure of 211x103 kg/sq. meter (300psi). It shall not displace water more than half its volume when left in water.

14.7.4 Wash Hand Basin

The wash hand basin is made as a ceramic ware, in one piece, of a material which is durable, impervious and corrosion resistant. Brackets are required for ordinary wash hand basin and pedestal is supplied with pedestal wash hand basin.

14.7.4.1 Source and Type

Wash Hand Basins shall be of an approved best quality and type manufactured in Pakistan. The normal size of the wash hand basin will be 80 cm x 40 cm (22"x16")

14.7.4.2 Composition

Wash Hand Basin shall be made of ceramic ware in one piece of material as approved.

14.7.4.3 Manufacture

Each Wash Hand Basin shall be fired at such a temperature as to produce satisfactory fused clay.

14.7.4.4 Quality

Each Wash Hand Basin shall show good workmanship without dents or faults. The surface and colour shall be uniform non-corrodible, free from discoloration and imperfections.

14.7.4.5 Colour

Colour of the wash hand basin shall be white or as approved.

14.7.4.6 Size

The size of the wash hand basin shall be as specified in the Bill of Quantities.

14.7.4.7 Overflow

Overflow shall be either of open ware type with removable grating or of a bolt type as specified. The slot for overflow shall be 63mm long 12.7 mm deep (2.5" long and ½" 0.50 inch, deep). It shall be so designed as to facilitate cleaning.

14.7.4.8 Soap tray or Sinking

Soap tray or sinking shall be so provided as to drain into the basin.

14.7.4.9 Tap Holes

The tap holes shall be square to fit pillar taps and shall be bevelled around the opening. They shall be so situated as to allow supply pipes to be clear of waste and vent pipes and shall have enough space to prevent the user striking the head on the tap.

14.7.4.10 Waste Hole and Grating

Waste hole shall have a minimum diameter of 63mm (2.5"). The outlet shall be bevelled or rebated. The tap hole shall be square in shape and each side shall be of 29mm (1.1/8") length. Chromium plated grating of appropriate diameter shall allow free drainage of water and be securely fitted to basin without any leakage.

14.7.4.11 Plug Chain and Stay Hole

Plug shall be of rubber. The diameter of the plug shall be such as to fit snugly in the waste hole. The chain shall be of brass / chromium plated steel one end fixed to the plug and the other end in the chain stay hole. The position of the stay hole shall not be lower than the over flow slot.

14.7.4.12 Brackets

Brackets shall be of an approved material. The length of the bracket shall be such as to enable 100mm (4") embedding in the wall or fixed to the wall with the help of screws.

14.7.4.13 Stud Slots

Stud slots shall be monolithically cast with the wash hand basin. These shall receive the brackets on the inside of the basin and shall be so situated that the brackets remain 50mm (2") away from the face. These shall not exceed 12.7 mm (1/2") in dia 7.9 mm (5/10" in height and shall be 300mm (12") from the back of the basin to the center of the side. The side studs shall be 63mm x 125mm x 16mm (2-1/8" x 5" x 5/8") and centre of stud shall be 300mm (12") from the back of the basin.

14.7.5 Waste Pipe

Waste Pipe shall be of 38mm (1-1/2") internal diameter. It shall be stainless steel, PVC painted with enamel paint, or chromium plated mild steel as specified in the Composite Schedule of Rates or BOQ.

14.7.5.1 Bottle Type Trap

All the wash hand basins shall be provided with a bottle type trap (Chromium plated or stainless steel as approved) and connected with the basin and waste pipe.

14.7.6 CP (chromium plated) Soap Dish

14.7.6.1 Source and Type

C.P. Soap dish shall be of an approved best quality and type manufactured in Pakistan.

14.7.6.2 *Composition*

It shall be made of best quality materials duly chromium plated in accordance with the latest specifications as approved.

14.7.6.3 *Quality*

It shall be of best quality and show good workmanship. The surface and colour should be uniform non-corrodible, free from discoloration and imperfections.

14.7.6.4 *Size*

The size of the CP Soap dish shall be as approved or as specified.

14.7.7 CP (chromium plated) Toilet Paper Holder

14.7.7.1 *Source and Type*

The C.P. Toilet Paper holder shall be of an approved best quality and type manufactured in Pakistan.

14.7.7.2 *Composition*

It shall be made of best quality materials duly chromium plated in accordance with the latest specifications as approved.

14.7.7.3 *Quality*

It shall be of best quality and show good workmanship. The surface and colour should be uniform non-corrodible, free from discolouration and imperfections.

14.7.7.4 *Size*

The size of the toilet paper holder shall be as approved or as specified.

14.7.8 CP (chromium plated) Towel Rail

14.7.8.1 *Source and Type*

C.P. Towel Rail shall be of an approved best quality and type manufactured in Pakistan.

14.7.8.2 *Composition*

It shall be make of best quality iron pipe duly chromium plated in accordance with the latest specifications as approved.

14.7.8.3 Quality

It shall be of best quality and show good workmanship smooth surface and colour should be uniform non-corrodible, free from discolouration and imperfections.

14.7.8.4 Size

It shall be of 3/4" dia x 24" long (19mm dia x 600mm long).

14.7.9 Mirror

14.7.9.1 Source and Type

Mirror shall be of best quality made in Belgium or local as specified make with Chromium plated screws.

14.7.9.2 Composition

It shall be made of best quality materials in accordance with the latest British Standard Specifications as approved.

14.7.9.3 Quality

It shall be of best quality and show good workmanship and surface should be uniform and free from imperfections and distortion.

14.7.9.4 Size

Size of the mirror shall be 24" x 18" x 1/4" (600x450*6mm) or as specified.

14.7.10 Tooth Brush Holder with Tooth Paste Dish

14.7.10.1 Source and Type

Tooth brush holder with tooth paste dish shall be of best quality and type manufactured in Pakistan as approved.

14.7.10.2 Composition

Tooth brush holder with tooth paste dish shall be made of Stainless Steel.

14.7.10.3 Quality

Each tooth brush holder shall be of best quality and show good workmanship. The surface and colour should be uniform, non-corrodible, free from discoloration and imperfections.

14.7.10.4 Size

Size of the tooth brush holder shall be as approved.

14.7.11 Plate Glass Shelves with CP Guard Rails*14.7.11.1 Source and Type*

Plate glass shelves with C.P guard rails shall be of an approved best quality and type manufactured in Pakistan as approved.

14.7.11.2 Composition

It shall be made of best quality materials in accordance with the latest specifications as approved.

14.7.11.3 Quality

It shall be best quality and show good workmanship. The surface and colour should be uniform, non-corrodible, free from discoloration and imperfections.

14.7.11.4 Size

It shall be of the size 24" x 5" x 3/16" (600x125x5mm) or as specified.

14.7.12 C.P. (chromium plated) Hanger*14.7.12.1 Source and Type*

The C.P. hanger shall be of an approved best quality and type manufactured in Pakistan.

14.7.12.2 Composition

It shall be made of best quality materials duly chromium plated in accordance with the latest specifications.

14.7.12.3 Quality

It shall be of best quality and show good workmanship. The surface and colour should be uniform non-corrodible, free from discoloration and imperfections.

14.7.12.4 Size

The size of the C.P. hanger shall be as approved.

14.7.13 One Hole Mixer*14.7.13.1 General*

- a. One hole mixer for wash basin.
- b. One hole mixer high cock for sink.

One hole mixer shall be chromium plated and of best quality manufactured in Pakistan. These shall be of screw down type with jam nut. Internal diameter of the tap shall be 13mm (1/2").

14.7.14 CP Shower and CP Arms

14.7.14.1 Source and Type

The C.P. Shower with arms shall be of an approved best quality and type manufactured in Pakistan.

14.7.14.2 Composition

It shall be made of best quality materials duly chromium plated in accordance with the latest specifications as approved.

14.7.14.3 Quality

It shall be of best quality and show good workmanship. The surface and colour should be uniform non-corrodible free from discoloration and imperfections.

14.7.14.4 Size

The C.P. shower shall be from an approved manufacturer and of the sizes specified.

14.7.15 Urinals

Urinals shall be of the best design and quality manufactured in Pakistan and as approved.

14.7.15.1 Composition

Urinal shall be made as a ceramic ware in one piece of material as specified.

14.7.15.2 Manufacture

Each urinal shall be fired at such a temperature as to produce a satisfactory Fused Clay.

14.7.15.3 Quality

Each urinal shall show good workmanship without dents or faults. The surface and colour shall be uniform free from discoloration and imperfections.

14.7.15.4 Colour

Colour of the urinal shall be white or as approved.

14.7.15.5 Flushing Cistern

4.5 litres capacity automatic C.I. cistern best quality local made enamel painted or Ceramic type best quality local made as specified in the Bill of Quantities.

14.7.15.6 Type

The type of the urinal shall be as approved.

14.7.15.7 Waste Pipe

Waste pipe shall be of 38 mm (1-1/2") internal diameter. It shall be manufactured either from stainless or mild steel or non-ferrous materials as approved. The steel pipe shall be either galvanized (internally and externally) or chromium plated as approved.

14.7.15.8 Brackets

Brackets shall be painted iron. The bracket shall be either of such a length as to enable 100 mm (4") embedding in the wall or shall be such as to be fixed to the wall with the help of screws.

14.7.16 Sink

14.7.16.1 Source and Type

Sink shall be of best quality and type manufactured in Pakistan and as approved.

14.7.16.2 Composition

It shall be made of 18 gauge stainless steel or as approved.

14.7.16.3 Quality

Each sink shall show good workmanship without dents or faults. The surface and colour shall be uniform, non-ferrous free from discoloration and imperfections.

14.7.16.4 Size

Size of the sink shall be as specified in the Composite Schedule of Rates or Bill of Quantities.

14.7.17 Bath Tubs

Bath tubs are manufactured as ceramic ware in one piece of material which is durable, impervious and corrosion resistant. The common colours of the tubs are white, yellow, green, blue, pink and ivory. Ordinary bath tubs are made of cast iron with porcelain enamelled inside. Nowadays acrylic fibre glass tub are very popular and replaces traditional cast iron pipes.

The outside may be painted as desired. The common size of the bath tub is 72"x30"x23". The bath tub is provided with a 1-1/2" trap overflow and anti-siphonic arrangements and connected to the waste and anti-siphonic stacks on the outside wall. Waste water may be allowed to be discharged through overflow trap, if so desired. It is fitted with two chromium plated pillar taps and a chromium plated chain with a plug. Two control cocks of 1-1/2" each are provided with every bath tub.

14.7.17.1 Source and Type

Bath tubs shall be of an approved manufacture.

14.7.17.2 Composition

Bath tubs shall be made as ceramic ware in one piece of material as specified. Ordinary bath tubs shall be made of cast iron, porcelain enamelled from inside.

14.7.17.3 Manufacture

14.7.17.4 Each bath tub except that made of cast iron shall be fired at such a temperature as to Source and Type

14.7.17.5 Quality

Each bath tub shall show good workmanship without dents and faults. The surface and colour shall be uniform, non-corrugible, non-plumber ferrous, free from discolouration and imperfections.

14.7.17.6 Colour

Colour of the bath tub shall be as specified.

14.7.17.7 Size

The size of the bath tub shall be as specified.

14.7.17.8 Fittings

Each bath tub shall be equipped with fittings as specified.

14.7.17.9 Measurement

The measurement of bath tubs shall be in numbers. The unit of measurement shall be unity.

14.7.17.10 Rate

The unit rate shall include the cost of bath tub, specified fittings, sorting, packing and delivery at Site of Work, to be defined in the Conditions of Contract.

14.7.18 Taps and Stop Cocks*14.7.18.1 Source*

Taps and cocks shall be of best quality manufactured in Pakistan and as approved.

14.7.18.2 Composition

The bodies and heads shall be of hard brass or gun metal or hot pressings of brass of manganese bronze. Spindles, glands, crutches, washer plates and nuts shall be of brass or manganese.

14.7.18.3 Quality

Castings shall be from metal poured into the moulds while hot pressing shall be metal pressed between dies.

Pressing shall be smoother and shall present a better appearance. These shall be plated with zinc or chromium as specified.

14.7.18.4 Requirements

Tap and cocks shall be fitted with a cover of pressed sheet metal threaded for attachment to the head and which can be cleaned easily. The stem of washer, plate (called 'jumper') shall be either loose or fixed by screwing to the spindle with the help of a grub screw.

14.7.18.5 Size

Size of the taps and cocks shall be as specified or as approved.

14.7.19 Floor Traps*14.7.19.1 Source and Type*

The floor trap shall be of an approved best quality and type manufactured in Pakistan.

14.7.19.2 Composition

It shall be made of best quality cast iron in accordance with the latest specifications with C.P. Grating of specified size.

14.7.19.3 Quality

It shall be made of best quality and show good workman- ship. The surface shall be uniform, non-corrodible, non-ferrous and free from imperfections.

14.7.19.4 Size

The size of the flow trap shall be as specified or as approved.

14.7.20 Gully Traps

14.7.20.1 Source and Type

Gully traps shall be of an approved best quality and type manufactured in Pakistan.

14.7.20.2 Composition

It shall be made of best quality earthenware duly glazed with 150x150mm cast iron gratings. A brick masonry chamber plastered with 1:3 cement sand mortar both inside and outside shall be constructed over the gully trap with C.I. frame and cover of required size.

14.7.20.3 Quality

It shall be of best quality and show good workmanship. The surface shall be uniform free from imperfections.

14.7.20.4 Size

It shall be (9"x9") 225mmx225mm) or as specified or approved.

14.7.21 Valves (Air relief valves, non-return valves, gate valves; etc.)

14.7.21.1 Source and Type

The valves shall be heavy duty and of an approved best quality and type manufactured in Pakistan.

14.7.21.2 Composition

- a. Air relief valve shall have small orifice valve, rubber balls, brass air vent orifices, gun metal nipple, screw down valve and seats, operating screws. The valve shall be capable to resist 153 meter of water pressure.
- b. Non-return valves body shall be of cast iron or bronze with gun metal seats and stainless steel hinges. The valve shall be capable to resist a pressure of 150 metre of water.
- c. Gate valves, heavy duty type brass, gun metal or bronze of best quality, manufactured in Pakistan as approved and capable to resist a pressure of 150 metre of water.

14.7.21.3 Size

As per the Bill of Quantities.

14.7.22 Manhole Cover and Frame

14.7.22.1 Source and Type

Manhole cover and frame shall be of Cast Iron of approved best quality and heavy duty type, manufactured in Pakistan conforming to BS 497 or as specified in the BOQ.

14.7.22.2 Quality

It shall be of best quality and show good workmanship. The surface shall be uniform, non-corrodible, non-ferrous and free from imperfections.

14.7.22.3 Size

18" (450mm) diameter weight 1/2 Cwt, or 24" (600mm) diameter weight 1 Cwt, or as specified in the BOQ.

14.8 Construction Requirements

14.8.1 Laying of Building Sewers/Soil pipes

Building sewer pipes and water service pipes shall be separated by 5 feet (1524mm) under the soil. This required separation distance shall not apply where the bottom of the water service pipe within 5 feet of the sewer is a minimum of 12 inches above the top of the highest point of the sewer.

Where separate systems of sanitary drainage and storm drainage are installed in the same property, the sanitary and storm building sewers or drains shall be permitted to be laid side by side in one trench.p0-

14.8.2 Drainage Piping Installation

Horizontal drainage piping shall be installed in uniform alignment at uniform slopes. The minimum slope of a horizontal drainage pipe shall be in accordance with Table 14-1.

Table 14-1: Slope of Horizontal Drainage Pipe

Size (inches)	Minimum Slope (in/ft)
2-1/2 or less	1/4
3 to 6	1/8
8 or larger	1/16

The size of the drainage piping shall not be reduced in size in the direction of the flow.

Drainage piping for future fixtures shall terminate with an approved cap or plug.

In the installation or removal of any part of a drainage system, dead ends shall be prohibited. Cleanout extensions and approved future fixture drainage piping shall not be considered as dead ends.

14.8.3 Pipe Joints

14.8.3.1 *Vitrified clay Pipe Joints*

Joints between vitrified clay pipe and fittings shall be made with an elastomeric seal conforming to ASTM C 425, ASTM C 1173.

Pipes shall have spigot and socket joints complying with relevant provisions of BS EN 295. Joints shall have elastomeric seals, complying with the relevant provisions of BS 2494 and shall be obtained from the pipe manufacturer. For pipes up to 150 mm diameter, push fit (sleeve type) polypropylene flexible couplings may be used in place of spigot and socket joints.

14.8.3.2 *Un-plasticized PVC (UPVC) Pipe Joints*

U-PVC pipe joints and fittings for gravity drains and sewers shall comply with the relevant provisions of BS 4660 and BS EN 1401-1.

Joints shall have elastomeric joint seals complying with the relevant provisions of BS EN 2949 and shall be obtained from the pipe manufacturer.

Solvent cements for jointing U-PVC pipes shall comply with BS 4346. For pipes and fittings complying with BS 4660, solvent cement may alternatively comply with BS 6209.

14.8.3.3 *Joints between different materials*

Joints between different piping materials shall be made with a mechanical joint of the compression or mechanical-sealing type conforming to ASTM C 1173. Connectors and adapters shall be approved for the application and such joints shall have an elastomeric seal conforming to ASTM C 425, ASTM C 443, ASTM C 564, ASTM C 1440, ASTM D 1869, ASTM F 477. Joints shall be installed in accordance with the manufacturer's instructions.

Joints between different types of plastic pipe or between plastic pipe and other piping material shall be made with an approved adapter fitting. Joints between plastic pipe and cast-iron hub pipe shall be made by a caulked joint or a mechanical compression joint.

14.8.4 Connection between Drainage Piping and Fittings

All connections and changes in direction of the sanitary drainage system shall be made with approved drainage fittings.

The fittings shall not have reductions capable of retarding or obstructing flow in the piping. Threaded drainage pipe fittings shall be of the recessed drainage type.

Fittings shall be installed to guide sewage and waste in the direction of flow.

14.8.5 Prohibited Joints and Accessories

The following types of joints and connections shall be prohibited.

- a. Cement or concrete joints
- b. Joints between different diameter pipes made with elastomeric rolling O-rings.
- c. Solvent-cement joints between different types of plastic pipe

14.8.6 Cleanout Plugs

Cleanout plugs shall be of brass or plastic, or other approved materials. Brass cleanout plugs shall be utilized with metallic drain, waste and vent piping only, and shall conform to ASTM A 74. Cleanouts with plate-style access covers shall be fitted with corrosion-resisting fasteners. Plastic cleanout plugs shall conform to the requirements of standards. Plugs shall have raised square or countersunk square heads. Countersunk heads shall be installed where raised heads are a trip hazard.

All horizontal drains shall be provided with cleanouts located not more than 100 feet (30,480 mm) apart.

Building sewers shall be provided with Cleanouts located not more than 100 feet (30,480mm) apart measured from the upstream entrance of the cleanout. For building sewers 8 inches (203 mm) and larger, manholes shall be provided and located not more than 200 feet (60,960 mm) from the junction of the building drain and building sewer, at each change in direction and at intervals of not more than 400 feet (122 m) apart. Manholes and man-hole covers shall be of an approved type.

A cleanout shall be provided at the base of each waste or soil stack.

Concealed piping, cleanouts on concealed piping or piping under a floor slab or in a crawl space of less than 24 inches (610 mm) in height shall be extended to the outside of the building. Cleanout plugs shall not be covered with cement, plaster or any other permanent finish material. Where it is necessary to conceal cleanout or to terminate a clean out in an area subject to vehicular traffic, the covering plate, access door or cleanout shall be of an approved type.

Every cleanout shall be installed to allow cleaning in the direction of the flow of the drainage pipe.

Cleanout openings shall not be utilized for the installation of new fixtures, except where approved and where another cleanout of equal access and capacity is provided.

Cleanouts shall be of the same nominal size as the pipe they serve up to 4 inches (100 mm). For pipes larger than 4 inches (100 mm) nominal size, the minimum size of the cleanout shall be 4 inches (100 mm).

14.8.7 Water Closets (WCs)

This work shall include providing and fixing of squatting type or European type WCs, in position, of an approved make, type and color, made of nonabsorbent material with specified diameter tap of the same material and foot rest. The surface shall have glazed finish with minimum of fouling area and a seal depth greater than 50 mm. The outlet shall be placed well back and the pan sufficiently long to meet the design requirement. The flushing water connection shall be from the rear end.

The European type water closet shall also be approved quality and supplied by an approved manufacturer; with low level flushing cistern and with double seat cover. The cistern shall be provided with a corrosion resistant alloy or plastic ball well with float of dia not less than 100 mm and additional 133 mm cock, provided with an overflow pipe at least with size larger than the supply pipe with a minimum internal diameter of 18 mm and fixed mild steel or cast iron cantilever brackets, if required or shown on the drawings.

The flush pipe shall be plastic PVC pipe. The holes for inlet, outlet and over flow in the cistern shall be made water tight by inserting rubber washers or other means of providing a water tight joint. The position of water closet shall be so arranged that a person sitting on it does not face QIBLA.

14.8.8 Traps

The following types of Traps are prohibited;

- Traps that depend on moving parts to maintain the seal
- Bell traps and
- Crown vented traps

Each fixture trap shall have a liquid seal of not less than 2 inches (51 mm) and not more than 4 inches (102 mm), or deeper for special designs relating to accessible fixtures. Where a trap seal is subject to loss by evaporation, a trap seal primer valve shall be installed. A trap seal primer valve shall conform to ASSE 1018 or ASSE 1044.

A trap shall not be larger than the drainage pipe into which the trap discharges.

Traps shall be set level with respect to the trap seal and, where necessary, shall be protected from freezing.

A recess provided for connection of the underground trap, such as one serving a bathtub in slab-type construction, shall have sides and a bottom of corrosion-resistant and vermin proof construction.

14.8.9 Gullies

Precast concrete gullies shall comply with the relevant provisions of BS 5911: Part 2.

Vitrified clay gullies shall comply with the relevant provisions of BS EN 295.

Coated cast iron floor gullies shall have a 90 mm diameter trapped outlet and be fitted with a galvanized flat grating of an approved type.

Floor drains shall be selected with sufficient grate free area to pass anticipated flow. The grate flow area is defined as the total area of the drainage openings in the grate and shall be not less than 1.5 times greater than the pipe to which the grate is draining.

With the exception of those located in toilets, all floor drains fitted with traps shall incorporate a removable bucket.

The gully shall be installed on a firm base and shall be located relative to the floor finish.

14.8.10 Access to Drains

Sufficient and suitable access shall be provided to enable all pipe work to be tested and maintained effectively. Access covers, plugs or caps shall be sited so as to facilitate the insertion of testing apparatus and the use of equipment for cleaning and/or the removal of blockages. The use of apparatus or equipment shall not be impeded by the structure of other services.

Access points shall not be located where their use may give rise to nuisance or danger if spillage occurs.

14.8.11 Interceptors and Separators

Grease interceptors or automatic grease removal devices shall conform to ASME A 112.14.3 or ASME A 112.14.4 and shall be installed in accordance with the manufacturer's instructions.

Interceptors and separators shall be provided to prevent the discharge of oil, grease, sand and other substances harmful or hazardous to the building drainage system, the public sewer, the private sewage disposal system or the sewage treatment plant or processes.

Grease interceptors and automatic grease removal devices shall receive waste only from fixtures and equipment that allow fats, oils or grease to be discharged.

A grease interceptor or an automatic grease removal device shall not be required for individual dwelling units or any private living quarters.

At repair garages, car-washing facilities, at factories where oily and flammable liquid wastes are produced and in hydraulic elevator pits, separators shall be installed.

14.8.12 Vents

The sanitary drainage system shall be provided with a system of vent piping that will permit the admission or emission of air so that the seal of any fixture trap shall not be subjected to a pneumatic pressure differential of more than 1 inch of water column (249 Pa).

The vent system serving each building drain shall have at least one vent pipe that extends to the outdoors.

All open vent pipes that extend through a roof shall be terminated above the roof, except that where a roof is to be used for other than weather protection, the vent extension at least 7 feet (2134 mm) above the roof.

Vent terminals shall not be used as a flag pole or to support flag poles, television aerials or similar items, except when the piping has been anchored in an approved manner.

An open vent terminal from a drainage system shall not be located directly beneath any door, openable window, or other air intake opening of the building or of an adjacent building and any such vent terminal shall not be within 10 feet horizontally of such an opening unless it is at least 2 feet above the top of such opening.

14.8.13 Air Admittance Valves

Stack-type air admittance valves shall conform to ASSE 1050.

Individual and branch type air admittance valves shall conform to ASSE 1051.

Individual, branch and circuit vents shall be permitted to terminate with a connection to an individual or branch type air admittance valve. Stack vents and vent stacks shall be permitted to terminate to stack-type air admittance valve.

Stack-type air admittance valves shall not serve as the vent terminal for vent stacks or stack vents that serve drainage stacks exceeding six branch intervals.

Access shall be provided to all air admittance valves. The valves shall be located within a ventilated space that allows air to enter the valve.

Individual and branch-type air admittance valves shall be located at a minimum of 4" (100 mm) above the horizontal branch drain or fixture drain being vented. Stack-type air

admittance valve shall be located not less than 6" (150 mm) above the flood level rim of the highest fixture being vented.

14.8.14 Measurement and Payment

14.8.14.1 Measurement

All pipes and fittings shall be classified according to their types, diameters, jointing and fixing. Pipes of different types and different types of joints shall be taken separately. The diameter shall be the nominal diameter of the internal bore.

Pipes shall be measured in running feet (meters) net as laid or fixed with overall fittings such as bends, junction, etc., which shall not be measured separately. The length shall be measured along the centre line of the pipes and fittings. Testing of pipe line shall be included in the item.

Cutting through walls, floors etc. and making good such cuttings shall be included within the item.

Measurement of all sanitary appliances and special fittings including different types of valves, etc. shall be made as per actual number acceptably installed. The Contractor's bid against these items shall include installation of complete unit as specified herein, inclusive of all work for connection with the sanitary system, complete in all respects.

14.8.14.2 Payment

The provision and installation of sanitary appliances and laying of pipes and fittings etc. shall be paid at the unit rate (s) of the relevant items given in Chapter 14 of Composite Schedule of Rates (CSR), or in the Bill of Quantities with Specified Unit Rates where applicable.

Payment for special items shall be made at the applicable unit rate (s) per number at the unit rate (s) of the relevant item (s) given in Chapter 14 of Composite Schedule of Rates (CSR), or in the Bill of Quantities with Specified Unit Rates where applicable.

Table of Contents

15	ELECTRICAL	8
	15.1 POWER TRANSFORMER	8
	15.2 STANDARDS	8
	15.3 SUBMISSION	9
	15.4 CLIMATIC ATMOSPHERIC CONDITIONS	9
	15.5 PRODUCT	10
	15.5.1 Type of Transformers	10
	15.5.2 Transformers Ratio And Vector Group Ref No	10
	15.5.3 Winding	10
	15.5.4 Transformer Terminals	11
	15.5.5 Tapings	11
	15.5.6 Transformer Protection	12
	15.5.7 Temperature Rise	12
	15.5.8 Vector Diagram and Symbols	12
	15.5.9 Information To Given On Rating Plates	12
	15.5.10 Arrangements of Information	13
	15.5.11 Tanks	14
	15.5.12 Fittings of Tanks	14
	15.5.13 Conservator with Fittings	14
	15.5.14 Finish	14
	15.5.15 Transformer Oil	15
	15.5.16 Iron and Copper Losses	15
	15.6 SCHEDULE OF TESTS FOR TRANSFORMER	15
	15.6.1 Transformer Oil Test	15
	15.6.2 Type Tests	15
	15.6.3 Routine Tests	15
	15.6.4 Temperature Rise Test for Mass Production	16
	15.6.5 Short Circuit Test From Mass Production	16
	15.6.6 Impulse Voltage Withstand Test From Mass Production	17
	15.6.7 General Requirements Of The Tests	17

15.6.8	Routine Tests	17
15.6.9	Type Tests And Special Tests	17
15.6.10	Sampling Procedure	18
15.6.11	Site Tests	18
15.6.12	Outline Specification	19
15.6.13	Installation of Transformer	20
15.6.14	TESTING & COMMISSIONING	20
15.6.15	WARRANTY PERIOD	21
15.7	PHOTOVOLTAIC MODULES	21
15.7.1	Codes and Standards	22
15.7.2	Product and Power Warranty	23
15.7.3	Quality	23
15.7.4	Efficiency of PV Modules	23
15.7.5	Construction Requirements	24
15.7.6	Tests	24
15.7.7	Factory Acceptance Tests (FAT)	24
15.7.8	Type Tests	24
15.7.9	Additional Independent Test	24
15.7.10	Site Tests	25
15.7.11	Manufacturing	25
15.7.12	Documentation	25
15.8	LUMINAIRES AND ACCESSORIES	25
15.8.1	Materials	26
15.9	Lighting Equipment, General Requirements	27
15.9.1	External Lighting	27
15.9.2	Installation	27
15.10	MAINS & SUB-CIRCUIT DISTRIBUTION	28
15.10.1	General Work Description	28
15.10.2	Submissions	28
15.10.3	Cable Installation	28
15.10.4	Final Sub-Circuit PVC Cable Installation	30

15.10.5	Non-Armoured Mains & Sub-Mains Cable Installation	30
15.10.6	Fire Resistant (FR) Cable Installation	31
15.10.7	Earth Continuity Conductor Installation	32
15.10.8	Cable Termination	32
15.10.9	Cable Identification	33
15.11	LOW VOLTAGE POWER CABLES - Part -1 General	33
15.11.1	Related Documents	33
15.11.2	DESCRIPTION OF WORK:	33
15.11.3	STANDARDS:	34
15.11.4	QUALITY ASSURANCE:	34
15.11.5	SUBMITTALS:	34
15.11.6	DELIVERY, STORAGE AND HANDLING:	35
15.12	EXECUTION Part-2	35
15.12.1	INSTALLATION	35
15.12.2	TESTING:	36
15.12.3	AS BUILT DRAWINGS	37
15.12.4	IDENTIFICATION	37
15.13	WIRING DEVICES	37
15.13.1	General Description	37
15.13.2	Standards	38
15.13.3	Submission	39
15.13.4	Product	39
15.13.5	Switches	40
15.13.6	Switched Socket Outlets	42
15.13.7	Fused Connection Unit	42
15.13.8	Isolation Switch (where required)	42
15.13.9	Weather proof Isolator (where required)	43
15.13.10	Lighting Dimmers Switch	43
15.13.11	Time Switches (where required)	43
15.13.12	Conactors	43
15.13.13	Telephone/Data Outlets	44

15.13.14 Bell Push Switches	44
15.13.15 Shaver Outlets (where required)	44
15.13.16 Cooker Control Units (where required)	44
15.13.17 Water Heater Switches (where required)	44
15.13.18 Power Supply For Lighting At Wet Condition	45
15.13.19 Local Switches	45
15.14 EARTHING SYSTEM (ROD TYPE)	45
15.14.1 GENERAL.	45
15.14.2 EARTHING SYSTEM COMPONENTS	46
15.14.3 EARTH INSTALLATION	46
15.14.4 TEST POINTS	47
15.14.5 EARTH PITS	47
15.14.6 MAIN EARTHING SYSTEM	47
15.14.7 THERMO WELD	48
15.14.8 Material	49
15.14.9 Quality Control	49
15.15 EARTHING SYSTEM (PLATE TYPE)	50
15.15.1 EARTH INSTALLATION	50
15.15.2 MAIN EARTHING SYSTEM	51
15.15.3 THERMO WELD	52
15.15.4 MATERIAL	53
15.15.5 QUALITY CONTROL	53
15.16 EARTHING SYSTEM (BORE TYPE)	53
15.16.1 SUBMISSION	55
15.16.2 EARTH CONNECTING POINT (ECP)	57
15.16.3 MAIN EARTH TERMINAL	57
15.16.4 RING CONDUCTOR	58
15.16.5 CONNECTIONS	58
15.16.6 EARTH BONDING	58
15.17 LIGHTNING PROTECTION SYSTEM	62
15.17.1 GENERAL DESCRIPTION	62

15.17.2	STANDARDS	63
15.17.3	SUBMISSION	63
15.17.4	PRODUCT	64
15.17.5	AIR TERMINATION	64
15.17.6	DOWN CONDUCTOR	64
15.17.7	JOINTS AND BONDS	65
15.17.8	TEST CLAMP / EARTH CONNECTING POINT (ECP)	65
15.17.9	EARTH TERMINATION	66
15.17.10	RING CONDUCTOR	66
15.17.11	EXECUTION	66
15.17.12	TESTING & COMMISSIONING	67
15.18	LIGHTNING PROTECTION SYSTEM	68
15.18.1	GENERAL	68
15.18.2	ELECTRONIC System Surge Protection	68
15.19	PUBLIC ADDRESS SYSTEM	70
15.19.1	GENERAL	70
15.19.2	AMPLIFIER RACK	71
15.19.3	Amplifier Mainframe	72
15.19.4	MICROPHONE INPUT MODULE	72
15.19.5	BALANCED LINE INPUT MODULE	73
15.19.6	MIXER AMPLIFIER	73
15.19.7	LOUDSPEAKERS	73
15.19.8	SOUND PROJECTORS	74
15.19.9	CEILING MOUNTED LOUDSPEAKER	74
15.19.10	COMPACT CABINETS (W/P)	74
15.20	FIRE ALARM SYSTEM	75
15.20.1	GENERAL	75
15.20.2	RELATED DOCUMENTS	75
15.20.3	SUMMARY	76
15.20.4	QUALITY ASSURANCE	76
15.20.5	PART 2- SCOPE OF WORK	76

15.20.6	SEQUENCE OF OPERATION	78
15.20.7	VOICE COMMUNICATION (OPTIONAL)	78
15.20.8	POWER REQUIREMENTS	79
15.20.9	FIRE ALARM CONTROL PANEL	79
15.20.10	MULTIPLE ADDRESSABLE PERIPHERAL NETWORK	80
15.21	PART 3 - ADDRESSABLE DEVICE TYPES	81
15.21.1	GENERAL	81
15.21.2	Addressable Sensor Bases	81
15.21.3	Addressable OPTICAL Smoke Sensors	82
15.21.4	Addressable Optical Heat Sensor	82
15.21.5	INTELLIGENT OPTICAL MULTI SENSOR	82
15.21.6	ADDRESSABLE PULL STATION	83
15.21.7	ADDRESSABLE DEVICE SUPERVISION	83
15.21.8	NOTIFICATION APPLIANCES	83
15.21.9	STROBES WITH SOUNDER (SINGLE UNIT)	83
15.21.10	INTEGRATION	84
15.22	CONDUIT SYSTEM, CABLE TRAY, CABLE LADDER AND TRUNKING INSTALLATION	84
15.22.1	GENERAL DESCRIPTION	84
15.22.2	STANDARDS	84
15.22.3	Steel Conduit and Accessories	85
15.22.4	PVC Conduit and Accessories	86
15.22.5	Conduit Installation	87
15.23	COMMUNICATION CABLING	91
15.23.1	TECHNICAL SPECIFICATIONS	92
15.23.2	Horizontal Cabling	92
15.23.3	Communication Cables	93
15.23.4	Category 6 UTP Cables	93
15.23.5	Cable Routing	94
15.23.6	Modular Equipment Cord	94
15.23.7	Voice Outlets / Information outlets	95

15.23.8	INSTALLATION PROCEDURES	96
15.23.9	System Documentation/Shop drawings	98
15.23.10	Numbering Scheme	98
15.23.11	Horizontal Cabling	99
15.23.12	Backbone Cabling	99
15.23.13	System Equipment	99
15.23.14	Cross Connect Log	99
15.24	Cabling	100
15.24.1	DATA SUBMITTALS	100
15.24.2	TESTING PROCEDURES	100
15.25	ADMINISTRATION DOCUMENTATIONS	101
15.25.1	As-Built Drawings.	101
15.25.2	CABLING STANDARDS	102
15.26	PABX	103
15.26.1	Installation	105
15.26.2	Testing	105
15.26.3	GUARANTEE & MAINTENANCE	105
15.27	IP BASED CCTV SYSTEM	105
15.27.1	SCOPE OF WORK	105
15.27.2	FIXED DOME / BOX TYPE IP COLOUR DAY/NIGHT CAMERA	106
15.27.3	PAN/TILT/ZOOM DAY/NIGHT INDOOR/OUTDOOR COLOUR DOME CAMERA	106
15.27.4	VIDEO MANAGEMENT AND RECORDING SYSTEM	108
15.27.5	Storage Requirements	111
15.27.6	CCTV Color LCD Monitor	111
15.27.7	INTEGRATION (OPTIONAL)	112

ELECTRICAL

15.1 POWER TRANSFORMER

- The intent of this Specification is to define the technical requirements for power transformer accessories.
- The works shall comprise the engineering, manufacture, routine testing at manufacturer's premises, supply, delivery to site and installation, testing and commissioning at site of the transformer.
- All items of accessories, fittings, sundries, apparatus or labour whether specified, in detail or not but which in the opinion of the Engineer are usual or necessary for the satisfactory completion of the transformers shall be included.
- The complete Transformer installation shall be engineering, manufacture to Local Authority specification and acceptance. The Contractor shall arrange whatever required satisfying Local Authority takeover requirement.

15.2 STANDARDS

- All plant items shall be engineering, manufactured and tested generally in accordance with the latest revision of the following standards except where specifically directed otherwise.

Items	Standard
1. Power transformer	IEC 76
2. Dry type power transformer	IEC 726
3. Measurement of transformer and reactor sound level	IEC 551
4. High voltage test technique	IEC 60
5. Partial discharge measurement	IEC 270
6. Code of Practice for earthing	BS7430
7. Transformer Oil	IEC 60296
8. Bushing	IEC 60137

- BS/IEC or other national standards not mentioned above but are applicable to the installation shall also apply.
- If the Specification conflict in any way with any or all of the above standards, the specifications shall have precedence and shall govern.
- Where deviation from the above standards is minor, the approval of the Engineer may be given to the use of other national or international standards prevalent in the Country of manufacture. No departure from the standard specified will be

considered after the Contract has been awarded unless specific authorization in writing has been granted by the Engineer.

- When the number of the IEC or BS standards is not specifically stated above, the IEC or BS standard used shall be the one most appropriate to the class of equipment, material or work done as specified by the Contractor.

15.3 SUBMISSION

Upon the request of the Engineer, the Contractor shall submit type test certificate issued by a National or International Testing Authority such as ASTA or KEMA on type tests which have been successfully performed on the transformer tendered.

The type test certificate shall show evidence of the following test:

1. Impulse voltage withstanding tests made in accordance with IEC 76 and IEC 60.
2. Temperature rise tested in accordance with IEC 76.
3. Short-circuit tested in accordance with IEC 76. Oscilloscopic records shall also be submitted.
4. Measurement of zero-sequence impedance.
5. Measurement of acoustic sound level.
6. Measurement of the harmonics on the no-loads current.

Should modifications be made to the manufacturer detail on the transformer, which may affect any, or all of the performance obtained from type tests already completed, the relevant type tests shall be repeated at the expense of the Contractor

At the appropriate stages of the Contract, the following shall be submitted for approval:

1. Detailed schedule of equipment and components and manufacturer's data.
2. Electrical control wiring diagrams.
3. Manufacturer's recommendations on all adjustable tripping devices.
4. Equipment weight.
5. Builders work requirements.
6. Heat dissipation from the transformer.
7. Testing and commissioning procedures.
8. Site test report.
9. As built drawings.
10. Operation and maintenance procedures.

15.4 CLIMATIC ATMOSPHERIC CONDITIONS

The transformers shall be designed and built to give efficient and reliable performance continuously at their full rate capacities in the climatic and atmospheric conditions prevailing at the sites, which are specified below: -

i)	Peak ambient air temperature	50°C
ii)	Mean maximum temperature during 24 hours	35°C
iii)	Minimum temperature	-5°C
iv)	Maximum relative humidity	95% at dry bulb
	Temperature of 43°C	
v)	Altitude	217m above Sea-level
vi)	Location	Lahore
vii)	Wind speed	20 Km/hr.

15.5 PRODUCT

15.5.1 Type of Transformers

The transformers shall be 3 phase, oil-immersed, self-cooled, core type, designed for Power distribution with off-load tap changing equipment. They will be used to supply LT distribution networks with lighting, power and HVAC-loads. The transformers shall be required to be continuously in circuit.

The system frequency is normally 50 complete cycles per second and primary 11,000 volts.

The transformers will be required to supply 11/ 0.415 kV, 3 phase, and supply underground secondary networks with the neutrals solidly earthed.

15.5.2 Transformers Ratio And Vector Group Ref No

The no-load ratio of the transformers shall be 11,000/ 415 volts. The high voltage windings shall be delta connected, the low voltage windings shall be star connected.

The impedance of each transformer shall be approximately 5%. The vector group shall be Dyn 11 for the transformers.

15.5.3 Winding

All windings shall be suitably insulated with class-F and shall have the end turn insulation specially reinforced at both ends of each phase to withstand the effects of abnormal transient pressure rises which may occur on the system either due to atmospheric lightning, switching or system faults.

15.5.4 Transformer Terminals

The three line leads on the primary high voltage side and the three line leads and the neutral on the secondary 415 volt side shall terminate on glazed porcelain insulators bushings for having a silicone coating, for connection to external circuits.

The high voltage bushing insulators shall have a spray coating of high insulating silicone. The minimum creep age distance for high voltage bushing shall not be less than 350 mm in conformance with IEC-137.

The connection terminal for L.V. bushing shall be of palm type.

Arcing horns shall be fitted on the high voltage bushings and set to discharge at about 80% of the impulse withstand voltage of the transformer and shall serve to keep the arc from the surface of the insulator.

Cores

The core material should be at least M-4 Grade. The cores shall have interleaved yokes which shall be securely clamped to reduce humming.

15.5.5 Tapings

Off load tapping shall be arranged on the primary side windings to give constant pressure of 415 volts at the secondary terminals when the primary line voltage varies normal (0%), + 2.5, +5%, & -7.5% for the given ratings of transformer

These tapping shall be brought to a single radial (rotary) tapping switch arranged for external hand operation. A register plate with means for clearly indicating the tapping in use shall be provided. Switch position No. 1 shall correspond to + 5% tap:

TAPPINGS (VOLTAGE RATIO = 11000/ 415 V)					
Tap Position (1)	Tap Position (2)	Tap Position (3)	Tap Position (4)	Tap Position (5)	Tap Position (6)
+5%	+2.5%	0%	-2.5%	-5%	-7.5%
11,550	11,275	11,000	10,725	10,450	10,175

The operating handle and the tapping indicator shall be located either on one side or on the top of the transformer.

Means shall be provided for securing and padlocking the tapping switch in any of the working position.

A rating plate showing the relative positions number of tap connections corresponding for different voltages.

15.5.6 Transformer Protection

The transformers will be protected by over-current and protective gear on the primary side and by fuses on the secondary side.

15.5.7 Temperature Rise

When the transformer is tested in accordance with the temperature rise above ambient of the windings core and oil, shall not go beyond the limits specified as per IEC 76-2.

- i) The maximum permissible temperature rise 45°C of the transformer oil (top oil)
- ii) Average temperature rise of the winding 55°C

All stipulated temperature rises shall not cause damage to the insulation of the windings or any part of the transformer or in any way adversely affecting the reliability and efficiency of the transformer.

15.5.8 Vector Diagram and Symbols

Reference to vector diagram shall apply to diagram below. The vector group symbol being DY 11 belonging to group with phase displacement of minus 30o.

The impedance shall be approximately 5%.

Line Terminal markings and vector diagram of induced voltages.

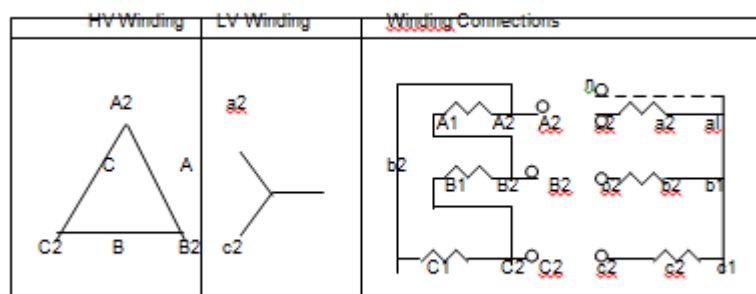

15.5.9 Information To Given On Rating Plates

All transformers shall be fitted with rating plates giving the information detailed in items 1 to 17.

- i. The number of this standard.
- ii. Manufacturer's name.

- iii. Manufacturer's serial number.
- iv. Rated KVA.
- v. Number of phases.
- vi. Frequency.
- vii. Rated voltage at no-load (higher-voltage / lower voltage).
- viii. Rated current higher voltage / lower voltage.
- ix. Impedance (%age).
- x. Winding connections and phase displacement symbols of vector diagram.
- xi. Diagram of connection.
- xii. Weight of complete transformer in Kg.
- xiii. Type of cooling.
- xiv. Total weight of oil in Kg.
- xv. Weight of core and windings assembly in Kg.
- xvi. Year of manufacturing.
- xvii. The word "FC-College" and purchase order number.

15.5.10 Arrangements of Information

The arrangement of the information given on the rating plate shall be as below:

kVA		Type of cooling	_____
Volts	HV _____	Frequency	_____
	LV _____	Impedance %ages	_____
(No load) Amperes	HV _____	Weight of Oil	_____
	LV _____	Weight of Core & Windings	_____
Phase	HV _____	Total weight	_____
	LV _____	Year of manufacture	_____
Diagram		Maker's Sr. No.	_____
Drg. No.	_____	FC college P. O.	_____
Vector Symbols	_____	No. & Date	_____

(Rating Plate for Transformer)

15.5.11 Tanks

The transformer tanks shall be constructed of welded boiler plates with external radiating tubes and shall be sufficiently robust to withstand transit to site with the transformer enclosed.

15.5.12 Fittings of Tanks

Lifting lugs of sufficient strength to lift the complete transformer filled with oil shall be provided on the tank. The lugs shall be so positioned so as to avoid any risk of damage by the clings to the tank, bushings or fittings during lifting. Four plain rollers shall be fitted to the bottom of the tank.

The transformer tanks shall also be fitted with: -

- i. Diagram plate.
- i. Rating plate
- ii. Drain valve.
- iii. Two separate earthing terminal.
- iv. Inspection hole with cover on top of transformer tank.
- v. Dial type thermometer with maximum temperature indicator needle painted red

15.5.13 Conservator with Fittings

All transformers shall be fitted with conservators, which should be detachable from the transformer to facilitate transport and shall be overhung on one side and not placed between the two bushings.

The conservator shall be fitted with:

- i. Oil gauge.
- ii. Drain valve.
- iii. Fitting hole with cover.
- iv. Dehydrating breather with filling of silica gel.

15.5.14 Finish

The transformers shall be painted with special anticorrosive paint, steel gray in color to withstand the atmospheric conditions prevailing at site which tends to have a strong corrosion inducing effect.

The paint shall be highly resistant to the effects of strong sunlight and high temperatures and shall have a long life under such conditions. As a minimum it shall

consist of a priming coat and two finish coats, which shall be applied after Shot blasting of the tank. The thickness of paint coating shall not be less than 0.12 mm.

15.5.15 Transformer Oil

Low viscosity insulating transformer oil conforming to the requirement of IEC-296 (amended to date) shall be used.

Laboratory reports of transformer oil shall be submitted along with the bidding documents.

All necessary documents for the purchase of oil should also be submitted along with bidding documents.

15.5.16 Iron and Copper Losses

Indoor Distribution Transformers having ratings as per BOQ, the limits of Copper and Iron Losses shall be as per standard, the tolerance of 5% is allowed for individual iron and copper losses for prototype production.

15% tolerance is allowed on individual Iron & Copper Losses for mass production subject to the condition that these losses shall not be more than the total losses (Iron & Copper) including 10% tolerance.

15.6 SCHEDULE OF TESTS FOR TRANSFORMER

15.6.1 Transformer Oil Test

The oil shall conform to IEC-296 (amended to date) clause-I oil: -

15.6.2 Type Tests

The following tests shall be got tested as per IEC-296 (amended to date) from any reputable lab. at the expenses of supplier/ manufacturer: -

- Oxidation stability.
- Dissipation factor.

15.6.3 Routine Tests

The following routine tests shall be carried out as per IEC-296 (amended to date) at manufacturer's lab: -

- Specific gravity of the oil.
- Viscosity.

- Flash point.
- Acidity value.
- Dielectric strength of the oil.
- Pour point.

15.6.4 Temperature Rise Test for Mass Production

The HEAT RUN TEST will be conducted on the total losses plus 10% tolerance.

The limits of temperature rise of oil and winding for routine testing to be carried out by Inspection Department will be 55oC & 60oC respectively. Limits of temperature rise of oil and winding for prototype shall be 53oC and 58oC respectively.

15.6.5 Short Circuit Test From Mass Production

Transformer of BOQ rating from mass production against tender/ contract shall be tested for short circuit withstands capability at H.V. & S.C. Testing Laboratory, WAPDA Rawat, Islamabad.

The short circuit test carried out on any one transformer against purchase order shall be acceptable for all other same rating transformers to be procured.

All expenses like testing fee, expenditure for transportation of transformer from manufacturer's premises to the testing lab. and traveling, boarding/ lodging allowance of two Engineers will be borne by the manufacturer.

In case the transformer sent to testing lab. fail, further supply of failing sizes of transformers will be stopped temporarily until the cause is found and set right. The improvements carried out shall be intimated by the manufacturer to Client/ Consultant.

Simultaneously, the WARRANTY PERIOD of the transformers against purchase order/contract shall be increased to period of 24 months from the date of receipt of transformers at consignee's store as against 12 months specified in clause "WARRANTY" of the Tender / Purchase Order.

The extended warranty shall be printed by the manufacturers on subsequent transformers.

After rectification the cause of failure manufacturer shall arrange a re-testing of same transformer.

If the transformer as above fails then the manufacturer will be disqualified for further orders.

15.6.6 Impulse Voltage Withstand Test From Mass Production

The impulse voltage withstand test shall be performed as per IEC 76-3.

15.6.7 General Requirements Of The Tests

The tests shall be carried out as per recommendation of IEC Publication 76 parts 1 to 5 (amended to date) and WAPDA/ LESCO Specification

All the routine, type and sample tests shall be carried out at the manufacturer's works except short circuit and impulse test which shall be carried out at an independent laboratory like KEMA of Holland, CESI, Italy, CRIEPT Japan or H.V. & S.C. Testing Lab. Rawat, Islamabad. The manufacturer shall provide all the testing facilities including high accuracy low loss instruments such as CTs, PTs, Watt meters and Voltmeters etc.

All the testing equipment should be calibrated from a reputable lab annually.

15.6.8 Routine Tests

Following routine tests shall be carried out on transformer by the manufacturer and a record in this regard shall be maintained which will be produced to the WAPDA/ LESCO engineer on demand: -

- i. Measurement of winding resistance.
- ii. Measurement of voltage ratio (turns ratio) and vector group.
- iii. Measurement of no load & full load losses.
- iv. Measurement of load losses and impedance voltage.
- v. Dielectric Tests.
 - a) Induced voltage withstand test.
 - b) Power frequency voltage withstands tests.
 - c) Bridge protection test (8 KV).
- vi. Tank pressure tests.
- vii. Transformer Noise measurement.

The test certificates shall be provided.

15.6.9 Type Tests And Special Tests

The following type and special tests will be conducted on each unit of the ordered transformers at High Powered Laboratories KEMA, Holland or locally available. One of our Engineers will witness the tests. All expenses in this regard will be borne by the supplier.

- i. Temperature rise test.
- ii. Di-electric tests (Impulse voltage withstand test).
- iii. Measurement of zero sequence impedance on three phase transformers.
- iv. Short circuit tests.
- v. Measurement of acoustic sound level.
- vi. Measurement of the harmonics on the no-load current.

15.6.10 Sampling Procedure

The following sample tests shall be conducted in presence of Client's engineers on the transformers offered for inspection from the mass production.

- i. Measurement of winding resistance.
- ii. Measurement of voltage ratio (turn ratio) and vector group.
- iii. Measurement of no load losses.
- iv. Measurement of load losses and impedance voltage.
- v. Dielectric Tests.
 - a) Induced voltage withstand test.
 - b) Power frequency voltage withstands tests.
- vi. Paint Thickness.
- vii. Bridge protection test at 8 KV.
- viii. Tank pressure test at 15 PSI.

For tin coating test and other allied test on the connectors, the sampling and testing shall be carried out one time.

Visual and dimensional test shall be carried out for both transformers.

The oil shall be tested as per IEC-296 (amended to date). The sampling of oil shall be done from the transformers tanks.

The impulse test shall be carried out on each transformer for and twice a year.

15.6.11 Site Tests

The transformers shall be fully tested on site prior into putting into service to ensure that all items are in proper working condition, correctly installed and free from damage.

An authorized testing Professional Engineer shall be engaged by the Contractor to perform the site testing and commissioning.

The following tests shall be made on the plant item together with any other tests which the Contractor deems necessary.

15.6.12 Outline Specification

The transformer shall be of the mineral oil, naturally cooled, (ONAN), 3-phase, indoor type, to BS 171/IEC 76.

Rated output	as mentioned in BOQ.
Number of phases	3
Frequency	50Hz
Voltage ratio at no-load	11000/ 415 volts
Impedance	5-6%
Vector group	Dyn 11
Off-load tapping	$\pm 2.5\%$, $\pm 5\%$, -7.5%
Temperature rise in oil	45°C
Temperature rise in winding (by resistance)	55°C
Ambient temperature	45°C
Copper losses at rated current]
Iron losses at rated voltage] to be provided by
Regulation at U.P.F & rated current] manufacturer/bidder
Efficiency at U.P.F]
100% rated load]
75% rated load]
50% rated load]
25% rated load]

The transformer shall be fitted and provided with the following:

- a) The width of transformer shall be maximum as shown on drawing.
- b) Off-load tap changer, externally operated, fitted with position indicator and locking arrangement.
- c) Dial-type thermometer, with maximum temperature pointer, and alarm/trip contacts.
- d) Double-float Bucholz relay, with testing facilities.
- e) Oil conservator
- f) Oil-level gauge, with level/temperature markings
- g) Silicagel breather, with oil bath
- h) Earth terminals, oil filling and drain plugs, lifting lugs, bi-directional rollers
- i) Nameplate (below conservator)

- j) First filling of mineral Oil

15.6.13 Installation of Transformer

The Contractor shall install, connect, and commission the transformers in accordance with the latest WAPDA/ LESCO Specifications, manufacturer's recommendations and good engineering practice.

All internal trenches, oil pits and sumps, and concrete foundations shall be constructed by others in accordance with shop drawings prepared by the Contractor, and executed under his supervision and guidance; the Contractor will be responsible for the correctness and co-ordination of these provisions. All grouting bolts, steel foundation channels, trench cable-brackets, hangers, straps, etc., shall be provided and installed by the Contractor at no extra cost.

11 kV cable connections and terminations shall be made using the manufacturer's recommended terminating kits.

The transformers shall be installed on steel channel foundations embedded in the floor, and the roller wheels locked to prevent movement. The Bucholz and temperature relay connections, 11kV cable installation on an angle-iron frame pedestal, and termination, with approved kit, at the transformer shall be carried out.

The electrical contractor shall provide all labor equipment and tools necessary for complete installation. The equipment shall be fixed firmly on floor as per manufacturer's recommendations. All outgoing and incoming cable connections shall be made and special care should be taken in fixing cable end boxes and cable connections so that no danger of leakage during operation is possible. The cable connection shall be made using proper size "Lugs" which shall be pressed with hydraulic compression machine. The cables shall be terminated using termination kits.

The contractor will also ascertain if arcing chambers are installed, oil has been filled, earthing has been connected, Earthing connections shall be made according to the earthing instructions.

15.6.14 TESTING & COMMISSIONING

Testing shall be conducted in two phases.

First phase of testing shall be done at the manufacturer's work, the following tests shall be performed as a minimum and the results recorded on test report sheets. These reports shall be submitted to the Engineer three days before the equipment is ready for witnessed testing.

- MV test, megger test, turns-ratio test, resistance test, no load test, winding over-frequency test, short-circuit test, oil dielectric strength test.

- Bucholz gas relay test.
- Temperature alarm/trip test.

The second phase of testing shall be carried out after installation on site (under supervision by the manufacturer's engineer), before commissioning of equipment, and shall include the following as a minimum:

- MV test on MV cable.
- Earthing resistance tests.
- Secondary injection tests on MV panels.
- Bucholz and temperature alarm/ trip circuit tests on transformer breaker.
- Operation tests and commissioning of the entire substation installation.

Final copies of all test reports and values shall be given to the Engineer in triplicate.

15.6.15 WARRANTY PERIOD

The damaged transformers under Warranty period will be repaired by the manufacturers /contractor free of cost with-in two months of receipt irrespective of the condition that it is damaged due to WAPDA fault or manufacturers fault. The transportation/handling charges etc. will be borne by Client, however manufacturer/contractor shall arrange a temporary transformer of same rating during repairing period.

For the acceptance of these repaired transformers under warranty period, all the routine tests shall be carried out for conforming suitability of further use.

15.7 PHOTOVOLTAIC MODULES

This Section describes the requirements for design, manufacturing, installation, testing and commissioning of the PV modules to be provided for the PV power plants. The Contractor shall provide PV Modules covering the following specifications under proper planning, execution of construction work, commissioning, operation and maintenance:

- PV Module Wattage 340 Wp
- PV Module Voltage 1500 V
- PV Module Dimension 2000*992*40mm

The nominal cumulative DC power of the PV power plant shall be sufficient for a minimum generation per year of at least 111084 MWh at POC and 109583 MWh after 1 year of operation after COD.

Moreover, the Contractor is requested to deliver at least 1% additional PV modules as spare part equipment.

15.7.1 Codes and Standards

The PV Module shall be designed, manufactured and tested in full compliance with the latest edition of the following, but not limited to, standards, codes, rules and regulations:

- EN 50262 Cable glands for electrical installations
- EN 50380 Datasheet and nameplate information for photovoltaic modules
- EN 60695-1-1 Fire hazard testing
- IEC 60216-1 Electrical insulating materials - Properties of thermal endurance - Part 1: Ageing procedures and evaluating of test results
- IEC 60529 Degrees of protection provided by enclosures (IP code)
- IEC 60891 Procedures for temperature and irradiance corrections to measured I-V characteristics of photovoltaic devices
- IEC 60904-1 Photovoltaic Device, Part 1: Measurement of Photovoltaic Current-Voltage Characteristics
- IEC 60904-3 Measurement principles for terrestrial Photovoltaic (PV) solar devices with reference spectrum irradiance data.
- IEC 60943 Guidance concerning the permissible temperature rise for parts of electrical equipment, in particular for terminals
- IEC 60990 Methods of measurement of touch current and protective conductor current
- IEC 61140 Protection against electric shock - Common aspects for installation and equipment
- IEC 61215 Crystalline silicon terrestrial photovoltaic (PV) modules – Design qualification and type approval
- IEC 61345 UV test for Photovoltaic (PV) modules
- IEC 61646 Thin film terrestrial photovoltaic (PV) modules - Design qualification and type approval
- IEC 61701 Salt mist corrosion testing of photovoltaic (PV) modules
- IEC 61730-1 Photovoltaic (PV) module safety qualification - Part 1: Requirements for construction
- CE Certification

In case international standards are not existing or inapplicable, recognized national standards accepted by the Employer shall be used.

15.7.2 Product and Power Warranty

The PV modules product warranty shall be guaranteed for minimum five (5) years.

The following minimum power warranties shall be guaranteed:

- First 10 years at 90% of the minimal rated power output
- Subsequent 15 years at 80% of the minimal rated power output

Linear power output characteristic is also accepted.

15.7.3 Quality

For the PV modules the quality certificate to IEC 61215 (crystalline) shall be provided. The flash data of each PV module shall be submitted to Employer.

The Contractor shall give specific attention for the compliance to IEC standard 61701 (Salt mist corrosion).

The Quality Management System of PV modules manufacturer shall be certified according to ISO 9001 by an internationally recognized Certification Authority.

The contractor has to deliver a quality control report. This report shall include the flash data of each module, thermography test and electroluminescence test.

15.7.4 Efficiency of PV Modules

The minimum efficiency of PV modules shall be 21%.

The efficiency of PV modules has to be determined under the following fixed standard test conditions (STC):

- Global horizontal irradiance $G_{GHI\text{STC}}$ of 1,000 W/m²
- Air mass of 1.5
- Cell temperature of 25 °C

The air mass is a measure for the length of the beam path through the atmosphere. Please note that it is only used for test conditions, which normally don't apply in practical operation.

The module efficiency is described by the following formula:

$$\eta_{STC} = \frac{U_{MPP} \times I_{MPP}}{G_{GHI\text{STC}} \times PV\text{ module surface}}$$

U_{MPP} : Voltage at maximum power point [V]

I_{MPP} : Current at maximum power point [A]

PV module surface : Total area of the PV module (frame included) [m²]

15.7.5 Construction Requirements

The PV modules shall be installed according to manufacturer standards and guidelines using only manufacturer approved components.

The covers shall be resistant against environmental influences (e.g. UV, dust, sandstorms, hail storms, salt-laden air, etc.)

Each PV module shall be provided with a unique identification code by the manufacturer as per their standards (e.g. barcode).

15.7.6 Tests

15.7.7 Factory Acceptance Tests (FAT)

The test program for the Factory Acceptance Tests (FAT) shall be submitted to Employer for approval at least 4 weeks prior to start of the tests. The test report shall be submitted prior to the shipment.

The Employer reserves the right to visit the PV modules factory at any time during manufacturing process to verify quality and timely production.

15.7.8 Type Tests

Type tests and verifications according to applicable codes and standards is not required to repeat, if a copy of the type test certificate is provided for same model.

15.7.9 Additional Independent Test

Additional independent certified Third Party tests of the PV modules shall be performed. The Contractor shall propose competent Third Party testing laboratory for Employer's approval. The Contractor shall organize and facilitate the Employer visit and/or testing in the factory if required. The Employer reserves the right to select PV modules randomly for the following tests as minimum:

- Module performance tests
- Module behaviour test (irradiation and temperature)
- Module electroluminescence tests
- Module thermography tests

All relevant costs for the above shall be borne by the Contractor.

15.7.10 Site Tests

The PV modules shall be tested at site to ensure their performance during:

- Pre-commissioning
- Commissioning and test on completion
- Performance tests

The site tests shall be witnessed by Employer. The commissioning test program shall be submitted at least 2 weeks prior to start of the tests.

15.7.11 Manufacturing

All PV modules for the PV power plants shall be manufactured in the same factory. However, if there is any reason that modules are manufactured in more than one factory the Contractor shall obtain prior approval from Employer and ensure that all concerned factories are having the same quality standards.

15.7.12 Documentation

Complete documentation shall be provided for the design, manufacturing, testing, installation, commissioning, start-up, operation, maintenance, repair and disposal of the PV modules and their components.

The Contractor shall provide as minimum the following documentation:

- Technical data sheets
- Reports of tests and commissioning with protocols
- Flash Test Report
- Installation and maintenance manual
- Factory testing quality protocol
- Guarantee
- CE Conformity Declaration.

15.8 LUMINAIRES AND ACCESSORIES

All lighting fixtures complete with lamps, accessories, installation materials, etc. shall be furnished and installed as per drawings. The fixtures shall be designed and built to give reliable service continuously at the normal voltage and current rating.

The light fitting schedule is given on the drawing and each type is specified in detail in the Bill of Quantities. The manufacturer's type and catalogue number specified shall serve as illustration of the type of fixture required and any other approved equivalent fitting shall be acceptable. The equivalency shall be based on certified photometric data, as well as on construction material, shape, finish, etc. The Contractor shall submit complete technical details and/or samples of each and every lighting fixture specified and obtain approval of the Consultant before commencing with placement of order.

15.8.1 Materials

Fluorescent fixtures shall be of the 22 gauge sheet steel, with anti-corrosion base treatment of the metal and white / grey stove-enamelling, with deep drying by infra-red lamps. Wire and bolts shall be of the corrosion resistant type. All components, high-efficiency fluorescent lamps, noiseless, low-loss high p.f. chokes, rotary location-type lamp holders, glow starters, with radio interference suppression and holders, matching capacitors in a duo-circuit to improve the p.f. to 0.95 etc., shall be compatible and of the best available quality.

All fluorescent light fixtures shall be provided with capacitors for improving the power factor to 0.9. The acrylic diffuser of fluorescent light fitting shall be 3mm thick. The body of the light fitting shall be minimum 24 gage sheet steel, finished in stove enamelled finish color as stated in manufacturer catalogue unless otherwise directed by the Consultant. Bushed wire entry holes and fixing holes of suitable size shall be provided. The mounting channels of fitting shall be painted with sprayed coat of white impact resistant coating of synthetic enamel.

Recessed type down or up-lighter shall consist of Aluminum reflector inside it and lamp. The glass shade or globe of incandescent light fittings shall be of superior quality glass, free from air bubbles or voids. The glass shall be opal white color or clear as specified. The incandescent fitting shall have bi-pin lamp holders of brass if not specifies in BOQ.

The surface-mounting incandescent or fluorescent light fittings shall be installed with the fixture back, flush with the ceiling surface. Nylon plugs shall be used for fixing the fixture on the ceiling or wall. The pendant-type fluorescent light fitting shall be hung from the ceiling by two 3/4 inch dia 16SWG white enamelled hanger at the top for fixing directly on to the recessed outlet box or on the ceiling. The recessed type fluorescent or incandescent light fitting shall be install recessed in the false ceiling by cutting the false ceiling to the required dimensions, such that the frame of the fitting overlaps the ceiling. The fluorescent fittings to be installed in a row shall utilize end plates to fix the fixture ends in level so as to form a continuous row without break or void.

15.9 Lighting Equipment, General Requirements

Complete manufacturers data shall be supplied along with the proposal of luminaries.

Lighting equipment and lighting fixtures shall be as called for on plans by designated symbols and type. Said equipment shall embody the highest standards of electrical and mechanical design with maximum efficiency obtainable and all shall be subject to the approval of the Engineer.

All hangers, cables, supports, channels, frames and brackets of all kinds for safely erecting this equipment in place, shall be furnished from the standard manufacturer's product range and shall be erected in place under this Section.

Each lighting fixture shall have a manufacturer's label affixed to it and shall comply with the requirements of all authorities having jurisdiction.

The right to select other fixtures of the same quality, without additional cost to the Employer is reserved by the Engineer regarding the shape of the lighting luminaire.

The supply to lighting fittings mounted on or recessed into a false ceiling shall be effected by means of a ceiling rose on a conduit box within the false ceiling space with a three core heat resisting flexible cable connection. When fixtures are surface mounted to the ceiling. Ceiling rose to be provided adjacent to the fitting. In plasterboard ceiling areas, ceiling rose to be installed and supported next to the luminaire with a back box to terminate the flexible conduit from the conduit box within slab at high level.

All prismatic controllers for fluorescent fittings shall be of the injection moulded acrylic type to obviate discoloration. Plastic diffusers will not be accepted.

15.9.1 External Lighting

Furnish and install external lighting fittings of the types specified and in the positions indicated on the drawings. Check all requirements regarding conduit runs and positions and the casting in of conduit.

The Contractor shall also be responsible for the installation and wiring of the external lighting installation as shown on the drawing and in accordance with the schedule of light fittings.

Each mounting bracket pole shall be fitted with a fuse unit of approved manufacturer connecting to the lighting units mounted on the bracket.

15.9.2 Installation

The light fixtures shall be installed on surface of wall / ceiling or recessed in false ceiling. All surface mounted fixtures shall be installed by means of galvanized steel

screws or bolts depending on the type of fixture and as advised by the Consultant. Light fixtures installed in the false ceiling shall be supported to the roof in order to avoid loading on false ceiling.

15.10 MAINS & SUB-CIRCUIT DISTRIBUTION

15.10.1 General Work Description

Mains and sub-circuit distribution cabling of the LV System shall be as shown on the Drawings and as specified hereinafter.

All mains and sub-circuit cables shall be in conduits, trunking, cable trays and ladders as appropriate. Armoured cables shall be used for all circuits in open ground in trenches or on open trays and ladders. All the mains, sub-mains and final sub-circuits shall include insulated earthing conductor sized in accordance with BS7671.

The current carrying capacities and voltage drops of cables shall be in accordance with BS7671, with ratings adjusted to suit local conditions.

Cable joint is not acceptable for all cable installation.

15.10.2 Submissions

All technical submissions shall be approved by the Engineer prior to the respective stages of construction.

1. Detailed schedule of cables & bus bars and manufacturer's data, Manufacturer's type test certificates and testing documents shall be submitted for inspection. Detail requirement of cable schedule as specified in Section 3, Wire and cables;
2. Calculations of voltage drop of cables;
3. Calculations of the prospective short circuit current;
4. Co-ordinated drawings showing all cable routings;
5. Builder's works requirement;
6. Detailed control wiring diagram.

15.10.3 Cable Installation

15.10.3.1 General

Cables shall be delivered on robust cable drums with cable ends treated to form an effective seal. When a cable is cut from a drum, the cable and the end left on the drum shall be immediately sealed in approved manner to prevent the ingress of moisture.

Cables shall be installed along the routes as indicated on the Specification and Drawings and shall be agreed in detail with the Engineer before any work is commenced. There is no cost adjustment to any routing of the cables as required to suit the installation and subject to site co-ordination.

All necessary precautions shall be taken to prevent damage to cables during installation.

Where cables are installed in situations where works by M&E Services are still incomplete, all reasonable precautions shall be taken to protect the cables against damages arising from the execution of such other works.

Cable laying shall be carried out by means of normal hand running off the cable drum. Roller guides shall be used all through and be drawn through by hands. No cable winches shall be employed.

Cable entries into buildings shall be hermetically sealed with an appropriate fire, heat and water-resistant, non-ageing, flexible material.

Cables shall be adequately protected against all risk of mechanical damage to which they may be liable in normal conditions of services.

Cables shall be installed in accordance with BS7671. In particular, the internal radius of every bend in a cable shall be such that as not to cause damage to the cable and not less than the appropriate value stated in BS7671.

Except for cables laid in ducts, all cables as specified herein shall run on cable trays/cable ladder, vertically and horizontally, and properly fixed in the prescribed manner. Where cables are laid on cable trays/cable ladder in the horizontal directions, nylon cable ties shall be used. Where cables are installed in the vertical direction, approved clips and saddles shall be used. The spacing of cable fixings shall be in accordance with BS7671.

Where three-phase power is run in single core cables, the cables shall be grouped in a trefoil formation and spaced from other cables. The relative position of the single-core cables of the trefoil group shall be changed through 120° at approximately one-third and again at two-thirds point of the entire cable route.

Not more than one circuit of single core cables or one multi-core cable shall be grouped together. The spacing between groups of single core cables or multi-core cables shall not be less than twice the diameter of the largest cable in the adjacent group of cables.

Where cables pass through structural elements such as floors and walls, the opening made shall be sealed with approved fire-resistant material of not less than two (2) hours fire rating or not less than the fire rating of the slab/wall to prevent the spread of fire.

Where cables pass through expansion joints, the cables shall be formed into a loop which shall be of such size that any movement in the joint shall not stress the cables.

15.10.4 Final Sub-Circuit PVC Cable Installation

In general, cables are to be run in zinc coated trunking to BS 4678; Part 1 or galvanized steel conduit.

Unless otherwise in plant rooms, within false ceiling and boxed up riser, all final circuit wiring shall be in concealed conduit in concrete slab, wall, column, etc.

NO PVC conduit shall be used, unless otherwise specified.

Cables in trunking shall be bunched in approved cable tie.

Trunking shall be properly sized to conform to IEE Regulations with minimum space factor of 45%.

BS Standard or relevant other Standards, name of the manufacturer, the voltage grade and the relevant BS number shall be printed on the outer sheathed insulation of the cables.

Cables for 3 phase, 4 wire system shall be colour coded – red, yellow, blue for phases, black for neutral and green/yellow for earth.

Minimum size of cable shall be 1.5mm² for lighting, 2.5 mm² for power and 2.5mm² for earth continuity subject to a maximum volt drop of 2.5% of the nominal voltage.

The cable size shall be selected to ensure that it has adequate current carrying capacity and that the voltage drop at the apparatus supplied does not exceed the approved limit. Derating of cables shall also be taken into account for adverse conditions.

Connection of fixtures shall be by the “loop-in & loop-out” method.

15.10.5 Non-Armoured Mains & Sub-Mains Cable Installation

In general, the cables shall be installed on cable trays or ladders. They shall be installed to an acceptable way conforming to IEE Regulations to prevent losses in cables and performance of the current carrying capacity.

Proper labeling shall be installed at every 6 m interval.

Avoiding of overlapping of cable is necessary.

A three phase circuit cables shall be installed on the same tray.

The cables shall be terminated in suitably tinned copper compression connectors.

Cables shall be routed at high level on proprietary make horizontal cable trays or cable ladders (for large cables) and support systems similar to UNISTRUT or other approved equivalent system. All vertical runs including cabling to switchboards, etc. shall be secured on approved type cable ladder system. For horizontal runs, cables shall be

secured neatly on the cable trays or ladders at close intervals by means of moulded polythene cleats similar to BICC "Telecleat" or other approved equal whereas claw cleats shall be used for securing vertical cables. Fixing shall be made with rawl bolts or other patented fixing devices of manufacturer details to the Engineer approval. Details of cable routes, terminations and support system shall be forwarded to the Engineer for review prior to installation.

Armoured Cable Installation

Armoured cables shall be laid and secured on approved type cable ladder system similar to BICC VANTRUNK or other approved equivalent system. The cable ladder shall be supported on proprietary make support system similar to UNISTRUT or other approved system. For horizontal runs, the cables shall be secured neatly on the ladder at close intervals by means of moulded polythene cleats similar to BICC "Telecleat" or other approved equal whereas claw cleats shall be used for securing vertical cables. Fixing shall be made with rawlbolts or other patented fixing services of manufacturer detail approved by the Engineer. Details of cable routes, terminations and support system shall be forwarded to the Engineer for review prior to installation.

Compression type glands for the termination of armoured cables shall be included with the terminating boxes supplied under the Contract. Marshalling and other terminating boxes supplied under the Contract, however, are to include the cable terminating glands.

The manufacturer detail of compression glands is to be such that the cable is not twisted when the gland is tightened. They are to provide facilities for the efficient bonding and termination of the armour wires and are to project at least 20mm into the terminating box so that any condensation collected on the inner surfaces of the boxes cannot flow down between the cable cores. Where anti-condensation heaters are not fitted, drain holes are to be provided. It is to be possible to erect and dismantle any cable compression gland without the use of special tools. Termination shall have IP rating the same as that of the switch board or equipment where the cables are connected to.

15.10.6 Fire Resistant (FR) Cable Installation

Fire Resistant cables shall be installed on a separate cable tray without sharing with other sub-main/control cables.

Fire Resistant cables shall be installed in accordance with the maker's recommendations and instructions. Fire Resistant cables shall be run on proprietary make horizontal cable trays, vertical cable ladders, trunkings or conduits depending on the sizes. For horizontal runs, Fire Resistant cables of larger sizes shall be secured neatly on the cable trays or ladders at close intervals by means of moulded polythene

cleats similar to BICC "Telecast" or other approved equal whereas fire resistant claw cleats shall be used for securing vertical runs.

All installation accessories shall be of manufacturer's standard products. Cable glands shall be of fire rating equal to the cable. The bending radius of the cables measured from the inside of the bend shall be not less than eight times the diameter of the cable or to manufacturer's recommendation, whichever is more.

For emergency final circuit, the FR cables shall be installed in GI conduit in concealed slab, wall, etc. unless otherwise approved by the Engineer.

15.10.7 Earth Continuity Conductor Installation

Each circuit wire shall have its own protective conductor with adequately sized in accordance with BS7671 using stranded copper cable with green/yellow PVC insulation.

In case of busbar enclosure may be used as earth conductor if earth busbar is not available.

15.10.8 Cable Termination

a) Tee-off

- Tee-off as required for tapping of power supply from the main riser cables to individual circuits shall be suitable for such purposes. Installation method must be submitted for approval prior to commencement of works. Under all circumstances, the conductors to be tee-off shall be secured by means of proprietary made compression type mechanical connectors, enclosed in plastic protective shell and filled with acrylic resin. No strand of a stranded conductor shall be cut away in making the tee-off.
- In the case of armoured cables, the earth continuity for the main cable and tee-off cable shall be maintained.

b) Cable Termination

- Cable shall be terminated using suitably chosen cable glands as specified.
- A PVC shroud as specified shall be fitted to cover the gland body.
- In the case of armoured cables, all armour and all faces of armour clamps of connectors making contact with them shall be thoroughly cleaned before termination and the clamps shall be adequately tightened to ensure good electrical contact.
- Cable conductor terminations shall be by means of heavy duty solderless cable lugs. The lugs shall be of high conductivity copper electro-tinned and applied to the conductor by means of a hydraulic crimping tool unless

otherwise specified. Heat shrinkable tapes shall be used for insulating the termination whenever possible.

c) **Armour Earthing**

- Metallic sheaths and/or armour of all cables in the same circuit shall be solidly bonded together at both ends of their runs. The bonding shall extend from the earth lug or earth lug attached to the cable glands to the main earth system.
- The cross-sectional area of the bonding conductor shall be selected in accordance to BS7671.
- The bonding conductor shall be as short and straight as possible.

15.10.9 Cable Identification

Cables shall be provided with identification markers, at each end of the cable, at entry and exit points of buried ducts, and in such other positions as are necessary to identify and trace the route at any cable. Where cables are not enclosed in ducts and are of multiple runs, markers shall be provided at 15 meter intervals

Cable identification shall be assembled from elliptical profiled plasticised PVC markers, carrier strip and nylon ties, the complete assembly shall be suitable for a maximum service temperature of 70oC.

Every single core cable and every core of a multicore cable shall be provided with identification at its termination in the form of tapes, sleeves or discs of appropriate colours.

15.11 LOW VOLTAGE POWER CABLES - Part -1 General

15.11.1 Related Documents

Drawings and general provisions of the Contract, including General and Supplementary Conditions, apply to this Section.

15.11.2 DESCRIPTION OF WORK:

Work Included: Provide low voltage electrical conductor, cable, wire, and connector work as shown, scheduled, indicated, and as specified.

Types: The types of low voltage electrical conductor, cables, wire, and connectors required for the project include, but are not limited to, the following:

1. 600/1000 volt building wire and cable.
2. 600/1000 volt building wire and cable connectors.
3. 300/500 volt control/signal wire and cable.

4. 300/500 volt control/signal wire and cable connectors.

Application: The applications for cable, wire, and connectors required on the project are as follows:

- i. Power distribution circuitry.
- i. Lighting branch circuitry.
- ii. Appliance, receptacle and equipment branch circuitry.
- iii. Motor branch circuitry.
- iv. Control wiring.
- v. Outdoor lighting and power.

15.11.3 STANDARDS:

Products shall be designed, manufactured, tested, and installed in compliance with the following standards:

BS 6346	PVC insulated, armoured cables for voltages of 600/1000V and 1900/3300 V
BS 6004	Polyvinyl Chloride (PVC) insulated and PVC over sheathed cables - up to 300/500V - for electric power and lighting.
BS6724	Thermosetting insulated armoured cables - 600/1000V to 1900/3300V - with low emission of smoke and corrosive gases when affected by fire.

Where application of applicable codes, Trade Association standards, or publications appears to be in conflict with the requirements of this Section, an interpretation shall be obtained from the Architect/ Engineer.

15.11.4 QUALITY ASSURANCE:

Manufacturers: Provide products complying with these specifications and produced by the manufactures provide in the list with BOQ.

15.11.5 SUBMITTALS:

Drawing submittals shall include, but not be limited to, the following:

- The Contractor shall submit to the Engineer for review, a list of the proposed manufacturers of wire and cable, cable lugs, cable connectors and termination fittings listed herein. The Contractor may install wire and cable, cable lugs, cable connectors and termination fittings furnished by any manufacturer listed on the approved submittal.

- Cut sheets on all 300/500 and 600/1000 volt conductors with manufacturers name, ratings and capacities, insulation characteristics, and available colors, clearly listed.
- Cut sheets indicating all cable lugs, termination fittings and cable connectors.
- Cut sheets indicating types of conductor identification bands.

15.11.6 DELIVERY, STORAGE AND HANDLING:

Provide factory-wrapped waterproof flexible barrier material for covering wire and cable wood reels, where applicable; and weather resistant fiberboard containers for factory-packaging of cable, wire and connectors, to protect against physical damage in transit. Damaged cable, wire, or connectors shall be removed from project site.

Store cable, wire, and connectors in their factory-furnished coverings, and in a clean, dry indoor space which provides protection against the weather.

15.12 EXECUTION Part-2

15.12.1 INSTALLATION

General: Install electrical cable, wire and connectors as shown, in accordance with the manufacturer's written instructions, the applicable requirements of "Standard of Installation", and recognized industry practices to ensure that products serve the intended functions.

Coordination:

1. Coordinate cable and wire installation work with electrical raceway and equipment installation work, as necessary for proper interface.
2. Installer shall examine the areas and conditions under which cable, wire and connectors are to be installed and notify the Contractor in writing of conditions detrimental to the proper and timely completion of the work. Inspect wire and cable for physical damage. Do not proceed with the work until unsatisfactory conditions have been corrected.

600 Volt Building Wire and Cable:

1. Mains and feeders are to be run their entire length in continuous pieces without joints or splices[, unless otherwise indicated or noted].
2. Conductors may be run in multiple on sizes inclusive, provided all multiple conductors are the same size, length, and type of insulation, and are so arranged and terminated as to ensure equal division of the total current between all conductors involved.
3. Before any wire is pulled into any conduit, the conduit shall be thoroughly swabbed in such a manner as to remove all foreign material and to permit the

wire itself to be pulled into a clean, dry conduit. All conductors shall be pulled into the conduit at the same time.

300 Volt Control/Signal Cable and Wire:

1. Install all low voltage wiring in a suitable raceway except in areas with accessible (lay-in) ceilings unless otherwise noted on Drawings Where cable is routed without a raceway, bundle all cables and suspend to one foot above ceiling using loop rings on 5' centers. Do not run cable loose on top of suspended ceilings.
2. Do not attach cables to suspended ceiling supports or any mechanical, plumbing, or sprinkler piping. Conceal conduit except in mechanical rooms and areas where other conduit and piping are exposed. Fasten flexible conductors, which bridge cabinets and doors, neatly along hinge side and protect against abrasion. Tie and support the conductors neatly.
3. Number code or color code conductors appropriately for future identification and servicing of the system. Refer to consultant's advice for additional requirements.

15.12.2 TESTING:

Feeder Insulation Resistance Test: Each new [and reused existing] 600 volt feeder conductor shall have its insulation resistance tested after the installation is complete except for connection at its source and point of termination.

1. Tests shall be made using a Biddle Megger or equivalent test instrument at a voltage of not less than 1000 volt dc. Resistance shall be measured between phase, neutral, and ground conductors and from conductors to raceway (ground). Readings shall be taken after 30 seconds and 60 seconds of Megger operation at slip speed and insulation resistance shall not be less than the 1000 M Ω
2. New conductors which do not meet or exceed the insulation resistance values listed above shall be removed, replaced, and retested.
3. Where reused existing feeders fail to meet the above insulation requirements, notify the Engineer in writing for direction prior to placing the existing feeders back in service.]

Neutral Testing: After all feeder and branch circuit conductors are terminated, neutral to ground testing shall comply with the following:

1. The resistance of the system's neutral to ground shall be greater than 10 k Ω with the system bonding jumper disconnected.
2. Repeat neutral to ground test for neutrals of separately derived systems.

Pre-energization Check: Prior to energization, check all new [and reused existing] branch circuit cable and wire for continuity of circuitry and for short circuits. Correct malfunction when detected. No submittal is required for this test.

Voltage and Current Values: The voltage and current in each main feeder conductor shall be measured and recorded after all connections have been made and the feeder is under load.

Submittals: Contractor shall furnish all instruments and personnel required for tests. Submit four copies of certified test results to Architect for review. Test reports shall include conductor tested, date and time of test, test results, relative humidity, temperature, and weather conditions.

15.12.3 AS BUILT DRAWINGS

As-Built Drawings: Refer to Electrical Section.

15.12.4 IDENTIFICATION

Identification: Refer to Electrical Section.

15.13 WIRING DEVICES

15.13.1 General Description

The drawings for the lighting and power points indicate approximate positions of all lighting fittings, switches, power outlet points, isolating switch points and the like. The actual positions of all fittings, switches, the wiring details and cable routes shall be co-ordinated with M&E Services on site and submitted for the approval of the Engineer. All time and cost required to adjust the layout or adjust the completed installation to Engineer satisfaction and to suit site co-ordination is included in the Contract.

During the exact positioning of lighting and power points, due consideration shall be given to the operational requirements of the installation, the selection of the most accessible routes for wiring and the convenience of switching.

No additional cost will be entertained should the final positions be relocated within the same room or not more than five (5) metres away from the original locations due to any requirement.

For the purpose of this Specification and related Drawings, each lighting and small power point circuits shall in general be coded with a prefix to indicate the corresponding distribution board number; details on the circuit way and phase shall be submitted for the approval of Engineer.

Certain types of electrical equipment or systems involving sudden changes, or low frequency or of direct electric current such as fluorescent lamps, contactors, etc. shall be fitted with radio and television interference suppression components suitable to meet the levels specified in BS 800 "Limits of Radio Interference".

This section included the specification of the following :

1. Light point installation
2. Lighting Switches
3. Switched Socket Outlets
4. Fused Connection Unit
5. Isolating Switches
6. Weatherproof Isolator
7. Lighting Dimmers Switch
8. Time Switch
9. Contactors
10. Bell Push Switches
11. Shaver Outlets
12. Telephone/Data Outlets
13. Cooker Control Units
14. Water Heater Switches
15. Power Supply for Lighting at wet condition
16. Local Switches

15.13.2 Standards

The complete wiring installation shall be engineered according to manufacturer data and constructed in accordance with the latest revision of the following standards and the appropriate BS/IEC:

- i) BS7671: Requirements for Electrical Installation
- ii) BS 1363 : 13A Switched Socket Outlet
- iii) BS 3676 : Lighting Switches
- iv) BS 546 : 15A Switched Socket Outlets
- v) BS 800 : TV & Radio Frequency Interference
- vi) BS 1362 : 13A Cartridge Fuse-Link for Fused Connection Units
- vii) BS 3052 : Shaver Outlets
- viii) BS 3676 : Isolating Switches
- ix) BS 4662 : Conduit Boxes
- x) BS 5424 : Contactors

In the adoption of standards and requirements, the Contractor shall take the following precedence:

- i) Engineer's decision;
- ii) Local codes of practice;
- iii) Drawings;
- iv) Specification;
- v) International standards and requirements.

15.13.3 Submission

All technical submissions shall be approved by the Engineer prior to the respective stages of construction.

As a minimum requirement, the submission shall include the following:

1. Equipment catalogues submission with manufacturer's data;
2. Sample submission include all wiring accessories;
3. Shop Drawings of the lighting and power positions, circuit numbers, cable routings, switching arrangement, mounting height, etc. The positions and mounting heights shall be coordinated with other services. Fixing details of all wiring accessories shall also be included.
4. Drawings showing the installation details.
5. Labeling system
6. Builder's works requirement.

15.13.4 Product

Lighting Point Installation

The various types of light fittings to be supplied and installed are described in the drawings and the Schedule of Lighting Fittings on Drawing

Surface mounted light fitting shall terminate at a BS 4662 junction box having entries appropriate to the run of conduit and shall be complete with porcelain connector suitable for the size and number of connections to be made at the point and the wiring required to connect the specified fitting. Wiring to the light fittings within the false ceiling spaces shall be by means of heat resistant (butyl or silicon rubber insulated to BS 6500) cables i.e. between the junction box and the lamp holder/terminal blocks, in flexible conduits.

At every light fitting an approved type earthing terminal shall be provided for connection of the circuit protective conductor of the final circuit.

Ferrous metalwork shall be of minimum thickness of 1mm. treated against corrosion by galvanizing after welding or be lead primer or other approved process. Metalwork shall be painted with one priming coat, one under-coat and two top coats finished stove-enamelled matt white, unless otherwise specified.

Cables used for internal wiring of the lighting fittings shall be of appropriate type and size and number. Conductor shall be of size not less than $1.5 \text{ mm}^2/1\text{C}$ or the equivalent. The insulation of the cables shall be able to withstand throughout the life of the fitting the maximum temperature to which it will be subject in normal use without deterioration which could affect the safety of the fitting.

Cables within the lighting fittings shall be neatly bundled by nylon self locking cable ties; wiring shall be properly routed and secured away from control gear etc. wherever possible.

All cable terminations within the light fittings shall be suitably shrouded to the approval of the Engineer.

All lighting fittings shall be self-supporting complete with the appropriate fixing accessories such as clips, supporting brackets, suspension sets, nuts, washers, screws etc. for the proper installation of the fittings on different types of ceiling panels. Suspension sets shall be of adjustable type suitable to carry the weight of the lighting fittings and unless otherwise stated or indicated on Drawings, the suspension sets shall be generally 900 mm in length; exact lengths required shall suit site situations.

All lamps complete with control gear necessary in operational condition shall be provided together with the lighting fittings as specified.

15.13.5 Switches

Lighting switches, unless otherwise specified, shall be single pole, quick make and slow-break, silent switch action type with solid silver alloy contacts and totally enclosed switch action for flush or surface mounting as required.

Lighting switches shall be suitable for indoor or outdoor service according to location, housed in standardized purpose manufactured galvanized steel boxes completed with conduit knockouts made up into single or multi-gang units employing a grid switch system of fully interchangeable components at standardized fixing centers of matching switches of different types and ratings but of identical dimensions, push buttons, neon indicator lamps, blanking units, grids, steel boxes and plates all capable of integration into standard composite assemblies in any combination as required.

Grids shall be adjustable for variation in depth of plaster and for squaring errors and of the same type for surface or flush mounting.

Switches for public areas shall be of special designs/finishes, in accordance with the specific "Designer Range Series" of the products, selected and approved by the Engineer. Switches of other areas shall be of high-impact resistant polycarbonate. Color finishes shall generally be in white, as selected and approved by the Engineer. Switches in mechanical plant rooms and electrical sub-stations and switch rooms shall be of the metal clad type approved by the Engineer, mounted in flush or surface conduit boxes as specified elsewhere.

Switches located on brick or concrete walls shall be mounted in horizontal arrangement in plaster depth steel boxes or in galvanized steel boxes using box suspension straps and cover plates. Countersunk screws shall be provided for fixing to the conduit boxes.

Switches for external use shall be of weatherproof construction with IP65 rating, unless otherwise specified.

Samples of all switches, conduit boxes and plaster depth boxes shall be submitted to the Engineer for approval prior to installation.

Samples shall be rated for 10 Amps (minimum light switch rating 10A), 15 Amps or 20 Amps as determined by circuit load which for inductive lighting circuit shall be assessed at twice the steady state connected load current, one way or two ways as indicated on the drawings and fixed generally at a height of 1200 mm from floor level and where located in rooms the switch shall, where possible be located on the inside of the room on the handle side of the door as close to the door as is practicable.

An earthing terminal, connected to the earth continuity terminal shall be provided and connected to the circuit protective conductor at every lighting switch positions.

Single pole switches shall be connected to break the phase wire of the supply; the neutral wire shall not be routed through switch boxes.

Switches which are mounted in the same location shall be of multi-gang type, of the maximum number of gangs available.

All switches used shall be of an approved or prescribed item as required by local Authorities.

Circuit from different phase and circuit from emergency power should have separate switch plate.

However, the mounting heights for the electrical equipment and accessories shall be coordinated with the furniture layout and shall be as per site requirements to Engineer's / ID's instruction and approval. In general the mounting heights from FFL to center of fixtures shall be as shown in drawings or use the following if not mentioned here.

15.13.6 Switched Socket Outlets

Switched socket outlets shall be to BS1363 single pole 13 Amp 3 rectangular pin switch shuttered outlets, one or two gang for indoor service except otherwise specified and either surface or flush mounting galvanised steel conduit boxes according to location.

Switches shall be of the quick-make slow break type with silent, totally enclosed switch action and solid silver alloy contacts. Switched socket outlets for indoor use shall be housed in suitable galvanized steel boxes to BS 4662 with conduit knockouts. Types and finishes of socket plates shall match those for the lighting switches.

Generally switched socket outlets shall be positioned 300 mm above floor level except in plant rooms, kitchen, etc. where they shall be positioned 1400 mm above floor level or 150 mm above counters or benches whichever is suitable.

Switch socket outlet in all mechanical plant rooms, electrical switch rooms shall be of the metal clad type, with recessed or protected switch dolly, mounted in flush or surface conduit boxes as specified elsewhere.

All switched socket outlets used shall be of an approved or prescribed item as required by the local Authorities.

15.13.7 Fused Connection Unit

All fused connection units shall be double pole switched, rated at 13 Amp unless otherwise specified, with fuse-links to BS 1362.

Units shall be of moulded ivory plastic, flush mounted, suitable for housing into galvanized steel boxes to BS 4662 with conduit knockouts.

Fused connection units shall be of the same manufacture as 13 Amp socket outlets and of matching appearance.

Fused connection units provide supply to gas ignition of home appliance shall not be located in gas pipe compartment.

15.13.8 Isolation Switch (where required)

Isolating switches shall be of the current ratings and number of poles (generally double pole for single phase and 4-pole three phases) as indicated on the Drawings.

Isolating switches shall be of the totally enclosed pattern, metal-clad or polycarbonate with positive quick-make and quick-break action.

Switches shall be capable of passing and also interrupting their full rated current safely and without damage.

Ferrous materials shall be galvanised, switch handles shall be interlocked to prevent opening the cover with the switch "ON".

15.13.9 Weather proof Isolator (where required)

Weather proof enclosure shall be of the high impact, water resistant to IP65. The isolator provided shall complete with lockable device. Isolators shall be double-pole, 4-pole as specified.

15.13.10 Lighting Dimmers Switch

Lighting dimmer switch shall be the solid state, variable load, thyristor controlled type suitable for controlling fluorescent and or incandescent lighting circuits operating at $230V \pm 10\%$ 50Hz single phase AC supply.

Dimmer switch shall be manufactured to eliminate TV and radio frequency interference in compliance with BS 800.

The ratings of the dimmer units shall be suitable for lighting circuit specified on Drawing.

15.13.11 Time Switches (where required)

Time switches shall be self-contained units suitable for mains operation. All units shall have a self-starting synchronous motor with a single-pole fuse in the motor circuit, a 3-way terminal block and a thirty-six (36) hours spring reserve complete with an automatic solar dial.

When fitted, the solar dial shall be capable of switching ON at sunset and OFF at sunrise throughout the year by control of a secondary calendar dial with month and day settings, and the automatic switching time shall be adjustable.

Time switches shall be encased in a dust-tight metal casing have a hinged front cover with a clear perspex window. The casing shall be effectively earthed.

A manual bypass switch shall be incorporated with the time switch to facilitate maintenance of the latter.

15.13.12 Conactors

Contactors for lighting control, whether locally, remotely or through timer, shall comply with BS 5424: Part 1, utilization category AC-2, Class 3 intermittent duty, and shall have a current rating of not less than that of the outgoing switchgear to which they are connected, and in any case not less than 20A.

15.13.13 Telephone/Data Outlets

Telephone/Data outlets where called for shall be single or twin of the flush mounted type suitable to receive the plug-in telephone/data cable lead to the approval of the Local Authority. The finishes of the telephone/data outlet plates at various areas shall be as specified for lighting switches.

15.13.14 Bell Push Switches

Bell push switches shall be flush-mounted conforming to BS 3676 having a single-pole AC switch rated at 5 amps and marked with bell symbol.

15.13.15 Shaver Outlets (where required)

Shaver outlets shall comply with BS 3052 and shall comprise a 20VA continuously rated double wound isolating transformer to provide an earth-free AC supply at mains frequency, complete with self resetting thermal overload device fitted in the primary circuit an insulated voltage selector switch to provide either 115 or 230 volt output, one ON-OFF switch and one universal socket outlet suitable for British, American, Continental and Australian razor plugs, all contained in a recessed sheet steel box with insulated moulded front plate suitable for flush, mounting and suitably inscribed to give a clear indication of the voltages available at the outlet and the service of the outlet.

15.13.16 Cooker Control Units (where required)

Cooker Control Units shall be flush mounted conforming to BS 3676 having a double pole AC switch rated at 30 amps complete with pilot indicating lamps and a self adhesive plastic identification label mounted on a removable chassis contained within a steel box finished aluminium stoved enamel provided with conduit knockouts and earthing terminals. The cover plates shall be of the same finish as those specified for the lighting switches.

Associated connector units shall be provided adjacent to the cooker units.

Wirings between the cooker control units and associated connector units shall be provided in concealed conduits.

15.13.17 Water Heater Switches (where required)

Water heater switches shall be flush mounted conforming to BS 3676 having double pole AC switch rated at 20 amps fitted with pilot lamp and marked "water heater". The cover plates shall be of the same finish as those specified for the other switches. Associated connector units shall be provided next to the water heater units.

15.13.18 Power Supply For Lighting At Wet Condition

Residual Current Circuit Breakers shall be provided individually for each circuits serving lighting subject to wet condition.

15.13.19 Local Switches

The local switches shall be 10/20 amp. Gang type, one-way, two-way, intermediate or double pole as indicated on the drawings. Where more than one switch is indicated at any position multiple gang units shall be used.

Switches shall be of the quick start make, slow break type specially designed for AC circuits to BS Standards. The operation of the switch shall not depend wholly on the action of the spring. The switches shall generally be of the rocker operated type.

All switch boxes shall be supplied with adjustable steel grids and earthing terminals.

Generally, switch units shall be of the adjustable grid pattern and to be secured to the adjustable grid by means of screws. For flush mounting switches the switch-plate shall overlap all edges of the box by not less than 7mm. For surface mounting switches the switch plate shall finish flush with the edges of the switch boxes. Switches for water heaters and fan coil units shall be complete with neon indicator lights.

In Plant rooms the switch units shall be surface or flush as required.

Local switches shall be arranged in convenient positions for switching the various circuits and generally as indicated on the drawings.

The switches shall be of the same manufacture for a particular type of switch throughout the installation. All accessories in wet and damp areas shall be of the splash-proof type to IP54 protection standard.

All switch boxes should be galvanized steel.

To ensure easy and correct connection of the conductors during installation, the necessary terminal shall be easily identified, grouped in line, upward facing, captive and backed out prior to the installation.

All dimmer switches shall be suitably rated to the lighting load being Controlled with 25% spare capacity and shall be adequate for tungsten and / or fluorescent lighting as specified.

15.14 EARTHING SYSTEM (ROD TYPE)

15.14.1 GENERAL.

An Integrated Grounding System is one that establishes a single point ground (or earthing) system that achieves an acceptably low resistance ground and provides for a

low surge impedance path from any point in the system. This concept is often referred to as a Common Point Grounding (CPG) System.

15.14.2 EARTHING SYSTEM COMPONENTS

Grounding system shall be composed of the following components:

- Chemically activated grounding electrodes, commercially known as AGE-T.
- Thin wall, soft copper tubing of at least one half-inch diameter, of at least ninety-nine (99%) percent pure copper.

15.14.3 EARTH INSTALLATION

Active Green Earth (AGE-) is an electro-chemical grounding electrode that automatically conditions the soil/rod interface. This is accomplished by absorbing local moisture to facilitate the electrolytic process. The installation must be accomplished in such a manner as to encourage this process.

To install the AGE-T, first bore a hole in the selected location to a diameter of not less than six (6) inches to accommodate the Earth Conductivity Enhancement Compound (ECEC) and a depth equal to the length of the selected rod plus one foot.

Remove all of the tapes covering the absorption and electrolyte holes.

Insert the electrode in the bored hole to its full length. It is preferable to leave the top exposed and protected by the special wall assembly, as illustrated. Pour 2 to 4 liters of water in the hole as it is being back filled.

Tamp the earth in place, leaving space to reach the connections and to install the well access assembly.

Make the connection to the AGE-T copper electrode.

Do not install in a place where watershed or downspout carry-off will flood the unit. Provide for carry-off when you install. The unit may be cemented or paved around, providing above instructions are followed and may be installed indoors.

Upon completion of installation of the earthing system, resistance-to-ground (earthing connection) shall be tested with a resistance tester. Where tests indicate resistance-to-ground is over 5 ohms, appropriate action shall be taken to reduce resistance to 5 ohms or less, by installing additional, properly spaced, ground electrode and treating soils in proximity to ground electrode. A retest shall be performed to demonstrate compliance.

15.14.4 TEST POINTS

These points are for testing of earthing systems. At these points hot work can be separated and can be tested for continuity and resistance. Test points should be made of brass and solidly fixed to wall at a height of 1.5 meter.

15.14.5 EARTH PITS

These should be made of pre cast concrete with a cover lid and should be placed over the electrode in level with the finished ground level. The cover lid should have marking showing its number and written "Earth Electrode" .

15.14.6 MAIN EARTHING SYSTEM

The contractor shall adequately allow in his tender for the provision and the installation of a complete earthing system required to meet the following requirements and shall ensure that the entire electrical installation is effectively bonded to earth as per BS 7430 Standards.

The contractor shall ensure that the whole of the electrical installation is both mechanically and electrically continuous throughout and is bonded to a suitable main earth in compliance with the IEE regulations and BS Code of Practice.

A test connection link shall be provided for testing purposes.

The nominal cross-sectional area of all earth continuity conductors shall be in accordance with the IEE regulations

All switchboards shall be provided with copper earth bar continuously run along the switchboard frames.

All switchgear, metal conduit and trunking systems, metal frames, enclosures, lighting fittings and cables sheaths shall be bonded together and connected to the earth tapes of the appropriate switchboard. Similarly all earth pins and metallic plates of socket outlets, switches, accessories and enclosures shall be bonded to earth with earth continuity conductors. Each individual earth path shall be electrically continuous throughout its length from the farthest point of the associated part of the system back to the main earth.

All earthing cables shall be installed in accordance with the relevant requirements called for in the cables section of this specification.

All bonding leads in the form of cable having a standard conductor shall be terminated in sheathed sockets and shall be rigidly bolted to earthing terminals.

All earthing cables shall be insulated with a PVC sheath. Where connection of the earth lead to the main earth is made with a stranded cable, the earth lead shall be double insulated with PVC.

Earth cable shall have same construction details as of phase cables.

Equipotential bonding conductors (6 mm² minimum) must be provided for metal pipes, water pipes, metal doors and other extraneous conductive parts and brought to the main earthing terminal in ground floor electrical room for final connection to the main earth pits. The cables shall be concealed in slab / wall upto final connection point.

The metal doors, curtain wall, building structure, door frames in electrical room, substations shall be provided with equipotential bonding and connected to the main Earthing System. Contractor should prepare and submit separate shop drawings with details for the earthing system.

Main equipotential bonding conductors in relation to the neutral of the supply shall be as per table 54H of BS7671 : 2001.

The earth rods shall be copper, corrosion resistant.

Provide separate earth pits as required and shown in schematic

Contractor shall be responsible for Substation earthing as per LESCO requirements. The extraneous conductors parts in the building shall be bonded together. The metal underside of raised floor and support elements shall be bonded to the common bonding network in addition to the following:

Trunking, Tray , Chilled water / Sprinkler / Fire Fighting Pipe Work / Ductwork / HVAC Equipment, etc.

15.14.7 THERMO WELD

- General

This specification covers the exothermic welding system for use in making electrical connections. The system supplied under this specification shall include weld metal, molds, tools and accessories as required.

- Standards

The exothermic welding system furnished under this specification shall meet the applicable requirements of Standard for Qualifying Permanent Connections Used in Substation Grounding. Independent test data showing conformance to IEEE Std. 80 and IEEE Std. 837 shall be readily available.

The exothermic welding system supplied under this specification must be approved by consultant.

- System

The system provides the ultimate in permanent molecular bonding. The process of exothermic welding in which no outside source of heat or power is required. Exothermic welding system comprise a complete range of joints and molds to suit all electrical connection application including bar to bar, bar to earth rod, bar to steel surface, cable to bar, cable to cable, cable to earth rod, cable to rebar and cable to steel surface and electronic ignitor (control unit)

- Application

The exothermic welding system is used for in making electrical connections of copper to copper, copper to steel or copper to cast iron for grounding and cathodic applications.

Connections shall be suitable for exposure to the elements of direct burial in earth or concrete without degradation over the lifetime of the grounding system.

15.14.8 Material

Molds shall be made from:

- Graphite material capable of withstanding high temperatures that are capable of providing an average life of not less than fifty separate exothermic welds.
- Cordierite, refractory ceramic or other material suitable for a single connection.

Starting material (where used) shall consist of aluminum and copper and iron oxides. It shall not contain phosphorous, magnesium or any caustic, toxic or explosive substances.

Low voltage battery starting (where used), shall use an electric ignition system that does not use starting material.

Weld metal used for grounding connections shall contain copper oxide, aluminum and not less than 3% tin as the wetting agent. Weld metal used for cathodic connections shall not contain tin, but shall contain vanadium.

15.14.9 Quality Control

Weld metal shall be controlled at the factory and subjected to routing and rigid quality control inspection procedures. The batch control lot number shall be packaged with the product for shipment from the factory.

- Manufacturers shall be ISO9001:2000 certified.
- Manufacturers shall have been engaged in the design and manufacturing of exothermic connection systems for at least twenty (20) years.

15.15 EARTHING SYSTEM (PLATE TYPE)

GENERAL

An Integrated Grounding System is one that establishes a single point ground (or earthing) system that achieves an acceptably low resistance ground and provides for a low surge impedance path from any point in the system. This concept is often referred to as a Common Point Grounding (CPG) System.

15.15.1 EARTH INSTALLATION

Copper or of G.I. is buried into the ground at a depth of not less than 3 meter from the ground level.

The earth plate is embedded in alternative layer of coke and salts for a minimum thickness of about 15cm.

The earth wire (copper wire for copper plate earthing and G.I. wire for G.I. plate earthing) is securely bolted to an earth plate with the help of bolt nut and washer made of copper, in case of copper plate earthing and of G.I. in case of G.I. plate earthing.

Diagram:

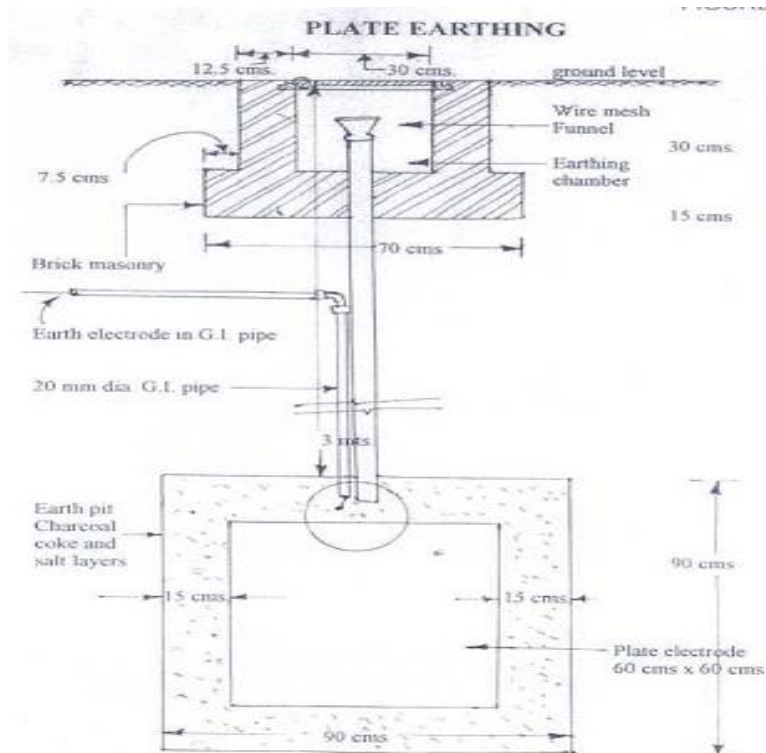

Upon completion of installation of the earthing system, resistance-to-ground (earthing connection) shall be tested with a resistance tester. Where tests indicate resistance-to-

ground is over 5 ohms, appropriate action shall be taken to reduce resistance to 5 ohms or less, by installing additional, properly spaced, ground electrode and treating soils in proximity to ground electrode. A retest shall be performed to demonstrate compliance.

TEST POINTS

These points are for testing of earthing systems. At these points hot work can be separated and can be tested for continuity and resistance. Test points should be made of brass and solidly fixed to wall at a height of 1.5 meter.

EARTH PITS

These should be made of pre cast concrete with a cover lid and should be placed over the electrode in level with the finished ground level. The cover lid should have marking showing its number and written "Earth Electrode" .

15.15.2 MAIN EARTHING SYSTEM

The contractor shall adequately allow in his tender for the provision and the installation of a complete earthing system required to meet the following requirements and shall ensure that the entire electrical installation is effectively bonded to earth as per BS 7430 Standards

The contractor shall ensure that the whole of the electrical installation is both mechanically and electrically continuous throughout and is bonded to a suitable main earth in compliance with the IEE regulations and BS Code of Practice.

A test connection link shall be provided for testing purposes. The nominal cross-sectional area of all earth continuity conductors shall be in accordance with the IEE regulations All switchboards shall be provided with copper earth bar continuously run along the switchboard frames. All switchgear, metal conduit and trunking systems, metal frames, enclosures, lighting fittings and cables sheaths shall be bonded together and connected to the earth tapes of the appropriate switchboard. Similarly all earth pins and metallic plates of socket outlets, switches, accessories and enclosures shall be bonded to earth with earth continuity conductors. Each individual earth path shall be electrically continuous throughout its length from the farthest point of the associated part of the system back to the main earth.

All earthing cables shall be installed in accordance with the relevant requirements called for in the cables section of this specification. All bonding leads in the form of cable having a standard conductor shall be terminated in sheathed sockets and shall be rigidly bolted to earthing terminals. All earthing cables shall be insulated with a PVC sheath. Where connection of the earth lead to the main earth is made with a stranded cable, the earth lead shall be double insulated with PVC.

Earth cable shall have same construction details as of phase cables.

Equipotential bonding conductors (6 mm² minimum) must be provided for metal pipes, water pipes, metal doors and other extraneous conductive parts and brought to the main earthing terminal in ground floor electrical room for final connection to the main earth pits. The cables shall be concealed in slab / wall upto final connection point.

The metal doors, curtain wall, building structure, door frames in electrical room, substations shall be provided with equipotential bonding and connected to the main Earthing System. Contractor should prepare and submit separate shop drawings with details for the earthing system.

Main equipotential bonding conductors in relation to the neutral of the supply shall be as per table 54H of BS7671 : 2001.

Provide separate earth pits as required and shown in schematic

Contractor shall be responsible for Substation earthing as per LESCO requirements. The extraneous conductors parts in the building shall be bonded together. The metal underside of raised floor and support elements shall be bonded to the common bonding network in addition to the following:

Trunking, Tray , Chilled water / Sprinkler / Fire Fighting Pipe Work / Ductwork / HVAC Equipment, etc.

15.15.3 THERMO WELD

GENERAL

This specification covers the exothermic welding system for use in making electrical connections. The system supplied under this specification shall include weld metal, molds, tools and accessories as required.

STANDARDS

The exothermic welding system furnished under this specification shall meet the applicable requirements of Standard for Qualifying Permanent Connections Used in Substation Grounding. Independent test data showing conformance to IEEE Std. 80 and IEEE Std. 837 shall be readily available.

The exothermic welding system supplied under this specification must be approved by consultant.

SYSTEM

The system provides the ultimate in permanent molecular bonding. The process of exothermic welding in which no outside source of heat or power is required. Exothermic welding system comprise a complete range of joints and molds to suit all electrical connection.

APPLICATION

The exothermic welding system is used for in making electrical connections of copper to copper, copper to steel or copper to cast iron for grounding and cathodic applications.

Connections shall be suitable for exposure to the elements of direct burial in earth or concrete without degradation over the lifetime of the grounding system.

15.15.4 MATERIAL

Molds shall be made from:

- Graphite material capable of withstanding high temperatures that are capable of providing an average life of not less than fifty separate exothermic welds.
- Cordierite, refractory ceramic or other material suitable for a single connection.

Starting material (where used) shall consist of aluminum and copper and iron oxides. It shall not contain phosphorous, magnesium or any caustic, toxic or explosive substances.

Low voltage battery starting (where used), shall use an electric ignition system that does not use starting material.

Weld metal used for grounding connections shall contain copper oxide, aluminum and not less than 3% tin as the wetting agent. Weld metal used for cathodic connections shall not contain tin, but shall contain vanadium.

15.15.5 QUALITY CONTROL

Weld metal shall be controlled at the factory and subjected to routing and rigid quality control inspection procedures. The batch control lot number shall be packaged with the product for shipment from the factory.

- Manufacturers shall be ISO9001:2000 certified.
- Manufacturers shall have been engaged in the design and manufacturing of exothermic connection systems for at least twenty (20) years.

15.16 EARTHING SYSTEM (BORE TYPE)

GENERAL DESCRIPTION

This section specifies the engineering, supply, installation, testing, commissioning and setting to work of the complete earthing network for individual earthing systems, circuit protective conductors and bonding conductors. A complete earthing network comprising cables, copper tapes, electrodes and earth bonding of all relevant necessary non-current carrying metal shall be supplied, erected and connected as required.

The system shall be a common earthing system as described in the Specification and as shown on the Drawings. Individual earthing systems shall be provided as follows prior to any according to drawing. Earth main MV/LV/Generator Electrical Earthing shall have 2 connection to the earthing system:

1. MV Electrical Earthing
2. LV Electrical Earthing;
3. Generator Earthing;
4. ELV Earthing;
5. Data Earthing;
6. Local Authority's Earthing;

Sufficient numbers of electrodes interconnect by copper tape or conductors to form earthing mat so that the overall earth resistance shall be less than 1 ohm for each individual earthing mat.

The numbers of earth electrodes of the earthing mat are indicated on the drawings as minimum. The Contractor shall test the resistivity of soil at site. Exact number of earth electrodes shall be determined by the Contractor to achieve the earth resistance value subject to Engineer approval. The complete earthing installation include earth plate, earth mat detail to achieve the earth resistance value shall be included in the Contract.

The Contractor shall inform the Engineer or his representative before driving stainless steel copper cladded earthing rods into the ground so that he may supervise the operation. Driving shall be carried out only in the presence of the Engineer or the representative as per defined procedure in drawings, BOQ & Specifications and all rods shall be submitted for the examination before use.

STANDARDS

- a) Complete earthing system shall be engineering and constructed in accordance with the latest revision of the following standards and the appropriate BS/IEC:
 1. BS7671 : Requirements for Electrical Installation
 2. BS7430 : Code of practice for Earthing
 3. BS EN 62305 : Protection against Lightning
 4. IEC 61024-1-2 : Protection of Structures against Lightning
- b) The detail of the Earthing System shall also conform to the requirements of all relevant local codes, as applicable, together with the additional requirements referred to in this Specification and Drawings, whichever is the more stringent and acceptable to the Engineer.
- c) In the adoption of standards and requirements, the Contractor shall take the following precedence:

1. Engineer's decision;
2. Local codes of practice;
3. Drawings;
4. Specification
5. International standards and requirements.

15.16.1 SUBMISSION

- a) All technical submissions shall be approved by the Engineer prior to the respective stages of construction.
- b) As minimum requirement, the submission shall include the following:
 1. Equipment Schedule, including all manufacturer's data;
 2. Shop Drawings and Sample Submission;
 3. Builder's work requirements;
 4. Testing procedures and report format for testing of the earth electrodes and/or earth strips;
 5. Soil resisting test report with calculation report for the details of the earthing system detail including quantity and layout of earth electrodes and/or earth strips to achieve the required earth resistance. The report shall be endorsed by the Contractor's Installation Engineer who supervise and endorse the installation upon completion;
 6. Proposed details of earthing system including quantity and layout of the earth electrodes and/or earth strips according to the calculation result.

PRODUCT

General

Common earth mats of resistivity of less than one (1) ohm, shall be constructed below the lowest floor structure prior to any ground work construction. The copper earth mats shall comprise the complete earth electrodes, earth strips/grids, earth inspection chambers, earth leads, main earth terminals, earth test link boxes at ground level, etc. Under this circumstance, each individual earthing system shall have earth leads connecting its main earth terminal directly to an earth electrode underground as specified.

In the case where drilling is required to take the earth rods or copper tapes below ground level, a specified earth resistance enhancement compound shall be added into the bored holes and a mixture at 60% bentonite and 40% of gypsum to 125% of water mixed to give thick slurry. It shall be grouted into the holes prior to inserting of rods or tapes, and be allowed to solidify. The hiring of machine drilling equipment and the grouting as described above shall be provided by the Contractor.

The earthing system shall be formed from copper conductors.

All copper clips, holdfasts, clamps, earth rod clamps, etc. shall be supplied by the same manufacturer of the copper tapes and rods.

All earthing products/accessories shall be of Local Authority's approved type.

The mating surface of all tapes/conductors at joints etc shall be cleaned before clamping and all joints shall be riveted, joint with proper connector or exothermic welded. All connectors to electrical apparatus shall be made by a bolted connection in a visible and accessible position

Copper conductor shall be secured with appropriate size copper saddles at intervals not exceeding 600 mm and the conductor shall be supplied in long unbroken lengths to avoid unnecessary jointing.

Earthing bores shall be made at 6'-0" away from foundation and distance between earth bore shall not be less than 10'-0" to achieve desire earth resistance mentioned in specification

EARTH ELECTRODE

Earth electrode rods shall be minimum 16 mm diameter extensible copper type with internal screw and socket joints, driving head and connection clamp.

Stainless steel copper clad rods shall have tensile strength of approximately 600 N/m².

Couplings for each section of the rod shall be of same material of the rod, threaded to fit the rod sections. Driving studs shall be used when driving the electrode into the ground. Earth values shall be measured and recorded before coupling and driving in the next section. Additional earth rods shall be driven in if necessary to attain the required effective earth values.

Clamping of the earth leads to the earth rod shall be made by earth clamp. The clamps shall be capable of providing a high pressure contact between the earth rod and the earth leads to achieve a low contact resistance.

When two or more electrodes are driven to form a group, the heads of the electrodes in the group shall be bonded to each other by means of a 25 mm x 3mm copper tape/70sqmm copper conductor, laid at a depth of at least 600 mm in soil.

All earth electrode penetrations through basement water proofing membranes shall be provided with manufacturer's recommended water seal insert sleeve approved by Engineer. The installation of the water seal insert sleeve shall be under the supervision and endorsed by the manufacturer's representative to ensure the installation comply with the manufacturer installation detail.

EARTH INSPECTION CHAMBER

Earth electrode shall be fitted with a heavy-duty precast concrete inspection chamber/pit complete with heavy-duty cover as specified on drawings.

For earth electrodes located outside or on the apron of the building, earth inspection chambers shall extend to a depth of not less than 300 mm below finished ground level and kept free of soil. For earth electrodes located inside building, earth electrodes shall be buried not less than 100 mm below the floor slab structure. Each earth electrode shall be clearly marked 'SAFETY ELECTRICAL EARTH CONNECTION – DO NOT REMOVE.

The chamber and cover shall be heavy duty detail to consider the traffic load at the location of installation. The cover shall be recessed cover to receive the Architectural floor finish at the location of installation.

EARTH LEAD

Earth leads, also commonly known as earth conductors, shall be used for the final connection between the earth electrodes and the main earth terminals.

Unless otherwise specified, earth leads shall be of 70sqmm copper conductor.

15.16.2 EARTH CONNECTING POINT (ECP)

Earth connecting point shall be of copper 200x50x6mm in size as specified.

ECP shall be CAD welded or joint with proper connector to earth electrodes underground below the floor slab structure, and shall be buried not less than 300 mm below the floor slab structure.

In order to minimise the mutual inductance between conductors, earth conductors shall be positioned at a distance not less than 6m apart unless otherwise specified.

15.16.3 MAIN EARTH TERMINAL

Main earth terminals shall be provided for the termination of each earthing system. 50mm x 6 mm tinned HDHC copper earth bars of not less than 300mm in length shall be installed in the respective plant rooms / switch rooms at a height of 300 mm above finished floor level. The insulators shall be the approved type. Interconnection between plant rooms/switch rooms and connection to earth electrodes shall be minimum 2 direct connection and as per the Drawings and/or as required to complete the installation.

Suitable earthing terminals shall be provided in all the equipment housings, switchgear enclosures, relayed and instrument casings and all other electrical metalwork for bonding to earth.

The earth connections for all sections of the installation shall be electrically continuous throughout back to the corresponding main earth terminals.

15.16.4 RING CONDUCTOR

A continuous ring conductor shall be provided to connect all substation Main Earth terminals installed in rooms as specified in drawing. The cross sectional area of ring conductor shall be of 70 sqmm Cu installed in G.I pipe or in trenches.

15.16.5 CONNECTIONS

Joints in the earth bars, copper tapes/ conductor and earth mats shall be exothermatically or butt weld or brazed such that the resistance of the section containing the joint shall not exceed that of an equivalent length at unjointed conductor. Any joint so made may be required to be tested to prove compliance with the requirement.

The contact faces of all protect conductors shall be cleaned and tinned before connections are made.

No drilling of the earth bar shall be permitted except in terminations.

15.16.6 EARTH BONDING

Circuit Protective Conductor

Circuit protective conductor (cpc) is a system of conductors joining together all exposed conductive parts and connecting them to the main earth terminal.

The purpose of circuit protective conductor is to provide a path for earth fault circuit so that the protective device will operate to remove dangerous potential differences during a fault condition.

The circuit protective conductors shall take the form of separate cable with a sheath in green/yellow colour or copper conductor of minimum size 70sqmm.

All exposed non-current carrying metal parts of light fittings, switchgears, motors, enclosures, etc. shall be effectively earthed by circuit protective conductors for earth continuity protection.

For equipment where an earth terminal is provided, the earth continuity wire shall be firmly clamped. Where no earth terminal is provided, the exposed metal part shall be cleaned of paint and surface rust before welding the earth continuity lead.

The minimum size of the principal protective conductors shall be as indicated below, the sizing of principal protective conductors shall be in accordance with to the current edition of BS7671 and BS7430.

Description		Min. Conductor Size
1.	Earthing conductor between the earth electrode and the MV switch room main earth terminal.	2 x 70sq mm (c/w 2 x 70 sq mm in ring to other main earth terminals)
2.	Earthing conductor between the earth electrode and the main earth terminal at LV switchroom.	2 x 70 sq mm (c/w 2 x 70 sq mm in ring to other main earth terminals)
3.	Circuit protective conductor between MV main earth terminal and the transformer neutral point.	2 x 95 sq mm (c/w 2 x 95 sq mm in ring to other main earth terminals)
4.	Circuit protective conductor between MV main earth terminal and MV switchboard	2 x 70 sq mm in ring
5.	Circuit protective conductor between LV main earth terminal and the LV switchboard.	2 x 70 sq mm in ring
6.	Circuit protective conductor between the earth electrode and the Generator room main earth terminal.	2 x 95 sq mm (c/w 2 x 95 sq mm in ring to other main earth terminals)
7.	Circuit protective conductor between Control Room/Local Authority's MDF room main earth terminals & their corresponding earth electrodes.	2 x 70 sq mm (c/w 2 x 70 sq mm in ring to other main earth terminals)

The external earth terminal on the outside of the end panel of any switchboard shall be connected to the main earth bar provided in two independent points.

Circuit protective conductors shall be provided in electrical and mechanical rooms and along the routes for the bonding of all exposed conductive parts and extraneous conductive parts. A suitably sized earth terminal shall be provided at each zone of the building for this purpose.

All exposed conductive parts shall be effectively connected in an approved manner to the principal protective conductors. The circuit protective conductors shall be single core copper cables or high conductivity annealed copper tapes specified. Unless otherwise specified, the minimum cross-sectional area of the circuit protective conductors shall be selected in accordance with BS7671:

**Cross Sectional Area (mm²
of Phase Conductors (S)**

**Cross Sectional Area of
Earthing or Protective
Conductor (mm²)**

$S \leq 16$	S
$16 < S \leq 35$	16
$S > 35$	S/2

An Earthing or Protective conductor size beyond 185mm² is considered not necessary.

Main Equipotential Bonding Conductor

This is referred to the conductor for the equipotential earth bondings of the metalwork of other services such as gas and water to the earthing system. This bonding of service pipes shall be made as close as possible to their point of entry to a building.

All extraneous conductive parts of the following services shall be connected to the main earth terminal by means of main equipotential bonding conductors:

1. Main water pipes;
2. Main gas pipes;
3. Other service pipes and ducting;
4. Risers of central heating and air conditioning system;
5. Exposed metallic parts of the building structure and as required by the Engineer;
6. Breeching inlets;
7. Fuel inlets.

The metalwork of public gas and water service shall not be used as a sole protective earth electrode.

Main equipotential bonding conductors shall have cross-sectional areas not less than half of the cross sectional area of the earth conductor of the installation, subject to a minimum of 6 mm² for copper cables. A conductor size beyond 25mm² for copper cables, theoretically, is considered not necessary.

Location of all incoming pipes and ducting shown on the Drawings are indicative only and are to be coordinated on site.

Supplementary Equipotential Bonding Conductor

This is referred to the conductor for the equipotential earth bonding of the metalwork which is not associated with the electrical installation but which may provide a conducting path giving rise to shock.

All extraneous conductive parts of the following shall be connected to the earthing system by means of supplementary equipotential bonding conductors:

1. Metal tanks;

2. All metallic cat-walks, platforms, handrails, staircases, ladders within 2m reach of pipes, tanks, cable trays cable ladders, trunking etc which have equipotential bonding.
3. Any metallic cat-walks, platforms, handrails, staircases, ladders etc with attached electrical cabling or fittings;
4. Metallic door frames/doors controlled by electromechanical locking mechanism with an operating voltage or supply voltage exceeding 50V.
5. Metallic support to electrically operated equipment without direct electrical contact with the equipment;
6. Electrically operated roller shutters;
7. Metallic wall cladding containing, or immediately adjacent to, electrical socket outlet or other sources of electricity;
8. Cable ladder, tray and trunking
9. Raised floor system;
10. Electrical facilities in toilets and shower rooms;
11. Exposed metallic parts of building structure, including roof trusses. (if roof trusses connect to lightning conductor earth, no further equipotential bonding is required).

The requirement does not apply in the following instances:

1. Steel reinforced concrete poles in which the steel reinforcement is not accessible;
2. Exposed conductor parts which owing to their reduced dimensions or their disposition cannot be gripped or cannot be contacted by a major surface of the human body, provided that connection of these parts to the protective conductor cannot readily be made or cannot be reliably maintained. This item applies to small isolated metal parts such as bolts, rivets, nameplates and cable clips. A major surface of the human body is considered to be 50mm x 50mm.
3. Fixing screws for non-metallic accessories provided that there is no appreciable risk of the screws coming into contact with live parts.
4. Short lengths of metal conduit for mechanical protection of cables having a non-metallic sheath.

Local supplementary bonding conductors shall be provided between simultaneously accessible (i.e. within 2m) exposed conductive parts of equipment, between exposed conductive parts and simultaneously accessible extraneous conductive parts, and between simultaneously accessible extraneous conductive parts. The bonding conductors shall be single core copper cables with oversheath in green/yellow colour.

Supplementary bonding, conductors shall be sized in accordance with BS7671 which can be summarized as follows:

1. For conductors connecting two exposed conductive parts, the conductor sizes shall not be less than the smaller protective conductor connected to the exposed conductive parts, subject to a minimum of 4 mm² if the cables are not mechanically protected;
2. For conductors connecting exposed conductive parts to extraneous conductive parts, the conductor sizes shall not be less than half that of the protective conductor connected to the exposed conductor parts, subject to a minimum of 4 mm² if the cables are not mechanically protected;
3. For conductors connecting two extraneous conductive parts, the conductor sizes shall not be less than 4 mm², or even 2.5 mm² if mechanically protected, for copper conductors.

All equipment equipotential bondings in area other than plant rooms and within false ceiling shall be concealed. Any remedial work required due to bad connection, open circuit, etc. shall be borne by the Contractor;

All earth conductors and earth terminals shall be manufactured to carry the maximum short circuit current at the point of the installation.

15.17 LIGHTNING PROTECTION SYSTEM

15.17.1 GENERAL DESCRIPTION

The work to be done under this section comprises the engineering, supply and installation necessary for the complete installation of the Lightning Protection System.

The Lightning Protection System shall be installed generally in accordance with BS EN 62305 and IEC 61024-1-2 and additional requirements of this specification. The system shall be of the Faraday-cage type and shall consist of air terminations, down conductors, joints and bonds, testing joints, earth terminations and earth electrodes. The general arrangement shall be as indicated on the Drawings.

The lightning protection system shall comprise:-

1. Air Terminations;
2. Down Conductors;
3. Joints and Bonds;
4. Test Links
5. Earth Terminations.

Lightning protection system employing steel structural and reinforcement system as part of the down conductors shall be adopted as per Drawing specified. All requirements in the specification included cast-in re-bar down conductors shall be applied unless otherwise specified.

15.17.2 STANDARDS

Complete installation shall be engineering and constructed in accordance with the latest revision of the following standards and the appropriate BS/IEC :

- BS EN 62305 - Protection against Lightning
- AS1768 - Lightning Protection
- BS7671 - Requirements for Electrical Installation
- IEC 61024-1-2 - Protection of Structures against Lightning

The detail of the lightning protection system shall also conform to the requirements of all relevant local codes, as applicable, together with the additional requirements referred to in this Specification and Drawings, whichever is the more stringent and acceptable to the Engineer.

In the adoption of standards and requirements, the Contractor shall take the following precedence:

1. Engineer's decision;
2. Local codes of practice;
3. Drawings;
4. Specification;
5. International standards and requirements.

15.17.3 SUBMISSION

All technical submissions shall be approved by the Engineer prior to the respective stages of construction.

As a minimum requirement, the submission shall include the following:

1. Equipment submission with manufacturer's data;
2. Sample submission;
3. Shop Drawings showing the co-ordinate routing of air terminations, down conductors bonding to re-bar and foundation earth terminations, methods of fixing etc.
4. Builder's works requirement.
5. Proposal on testing procedures and report format for testing of the Lightning Protection System.
6. Detail of the Contractor's installation Professional Engineer who supervise and endorse the installation for occupation permit application.

15.17.4 PRODUCT

15.17.5 AIR TERMINATION

The Contractor shall supply and install an air termination system consisting of continuous horizontal conductors.

The conductors shall comprise of 25mm x 3mm copper tape unless otherwise specified, located as shown on the Drawings and securely fixed in place to the building structure. Wherever possible, the horizontal conductors shall be continuous lengths.

Where saddled to masonry, the fixing screws shall be set in expansion type plugs contained in properly formed holes.

All roof conductors are to be secured at intervals not exceeding 900mm.

The Drawings showing the various roof levels of the building indicate the general arrangement and layout of the air termination system. The Contractor shall ensure that the whole of the air termination system is installed over its total route of the roof areas maintaining absolute electrical continuity.

Provision shall be made with suitable fittings to allow for expansion and contraction of the horizontal conductors.

500mm height vertical copper air terminal shall be provided for the Air Termination network fixing next to masonry material at the highest points and any connection to down conductor.

Air termination on the vertical side of the building above 45mm as required by code shall be provided with maximum 30m spacing and minimum 2 points. The Contractor shall co-ordinate the installation detail to allow for bonding of the curtain wall to the embedded down-conductor re-bar to Engineer satisfaction and comply with BS code requirement. All additional materials and installation as required shall be included in the Contract.

15.17.6 DOWN CONDUCTOR

The down conductor routes shall be embedded in column as indicate on drawing and shall be as direct as possible.

The bonding conductor at roof conductor shall be of soft annealed copper strip minimum size 25mm x 3mm. Where the conductors penetrate the roof, the holes shall be effectively sealed and waterproof with proprietary sealant to the approval of the specialist roofing contractor.

All exposed metal running vertically external to the structure shall be bonded to the re-bar down conductor. This shall be included but not limited to curtain wall frame, pipes, ducts and other metal components running through the Buildings.

The down conductors shall be run according to the route as shown in the Drawings or as required to BS code requirement.

The Sub-Conductor shall ensure that the proper material and equipment are used in accordance with the manufacture's recommended installation.

Lightning protection system shall employing steel structural or reinforcement as down conductor as per Drawing if specified. Additional stainless steel re-bar down conductors shall be embedded in columns or core walls to ensure continuity and run along steel reinforcement with bonding at maximum 1m interval or minimum two (2) points at each in-continuous steel structural member of reinforcement.

15.17.7 JOINTS AND BONDS

Stainless steel connection plates shall be provided for termination of exposed copper tape conductors to steel rebar down conductors concealed in structure. All joints and bonds shall be soundly secured and shall be of low resistance. The cross-sectional area of the material used e.g. Copper shall not be less than the main conductor (i.e. 25mm x 3mm) unless otherwise specified.

Where possible, joints shall be kept as few as possible. All joints shall be carried out with manufacturer's recommended compress type clamp. Two (2) screw minimum shall be provided for each joint.

Bonding Points shall be carried out with manufacturer's recommended sets. Customer's self-made items are not acceptable.

Joining of dissimilar metals shall be protected from moisture by applying recommended compound on the material. Bi-metal joint shall be provided where dissimilar metals are used.

All junction and bonding clamps shall be brass/phosphor bronze material.

15.17.8 TEST CLAMP / EARTH CONNECTING POINT (ECP)

A ECP shall be provided for testing earthing pit at ground floor. The ECP shall be of copper and shall be located in an easily accessible position for testing.

The ECP shall be protected from unauthorized interference. It shall be of an approved type and shall not constitute an electrical resistance within the system.

Test clamps suitable for copper conductor shall be provided at air termination network and Earth Termination for each down conductor and so arranged that all parts of the network can be tested independently.

After installation and completion of testing, all test clamps shall be painted with bituminous paint to prevent corrosion.

15.17.9 EARTH TERMINATION

Down Conductor rebar will be bonded to earth pit's ECP after Test Clamps by 70sqmm HDBC conductor in G.I pipe at the ground level along the perimeter of the building to comply with IEC 61024-1-2.

The maximum permissible earth resistance of the Lightning Protection System shall be 10 ohms. Testing earth electrode shall be provided for earthing test.

The top of each electrode shall be protected from damage by placing it in a heavy duty pre-cast concrete inspection chamber with heavy duty cover. The actual connection of the conductor to the electrode shall be accessible and visible when cover is removed.

15.17.10 RING CONDUCTOR

A continuous ring conductor shall be provided to connect all Lightning protection's earth pits. The cross sectional area of ring cable shall be 70 sqmm Cu/PVC installed in PVC conduit buried in ground.

15.17.11 EXECUTION

METALLIC CURTAIN WALL BONDING

All elements of the façade shall be directly earthed to the structure for the purpose of lightning protection. The Contractor shall make himself aware of the requirements under the latest revision of BS latest code and IEC 61024-1-2. All necessary connections, conductors, earthing connectors etc shall be deemed to be included in this Contract.

The Contractor shall co-ordinate with the Curtain Wall Supplier/Contractor for the exact interface and bonding requirements. The curtain wall is to be electrically continuous and the installation shall comply with BS EN 62305. Tests shall be carried out by this Contractor to the satisfaction of the Engineer to ensure electrical continuity as stipulated in the code.

Lightning protection bonding terminals along each re-bar down conductor shall be provided by the Contractor at the lowest levels and roof levels for bonding with curtain walls. Intermediate bonding terminals shall be provided at an interval of not exceeding 30m apart at each of the vertical intervals of each down conductor.

As a general practice, bonding points shall be provided and located on the internal face of the claddings. A conductor shall be provided and installed by the Contractor for lightning protection bonding at the down conductors.

The Curtain Wall Supplier/Contractor shall be required to confirm his details on the lightning protection bonding of curtain walls. It is the responsibility of this Contractor to ensure all details (both locations and quantity) agreed complied with BS latest code.

All metal cladding components including panels, glazing frames, mullions, transoms, fixings and support structures shall be fully bonded electrically to ensure electrical continuity of the building development.

EQUIPMENT/STRUCTURE BONDING ON ROOF & OTHER EXTERNAL AREA

The Contractor shall be responsible for bonding of all metal equipment/structure on roof and other exposed external area on flat roof and ground level, complete cabling by means of 25 x 3mm copper tape up to the termination point provided by respective Contractor. Bonding within the equipment for maintaining electrical continuity of all metal components will be provided by the respective work in the Contract.

All metallic projections, chimneys, vent pipes, cooling towers, railings, antenna masts, fuel tanks, etc. on or above the main surface of the roof and other external areas shall be bonded to and form the part of the air termination network.

For equipment with plan area above 100sq.m, bonding shall be provided at distance not more than 30m apart equally spaced along the perimeter of the equipment.

All bonding shall be to the nearest down conductor by most direct route available.

15.17.12 TESTING & COMMISSIONING

The Contractor shall arrange with the Engineer for inspection and testing of lightning conductor system. Before the joint testing, the Contractor shall have conducted his own inspection and testing to ensure that all requirements are met as specified. Test report certified by Contractor's installation Professional Engineer shall be submitted to the Engineer. All equipment, transportation, manpower and other necessary costs for the joint inspection and testing shall be borne by the Contractor.

The system shall also be tested at not greater than twelve (12) months intervals for earth resistivity, resistance to earth of the electrodes and electrical continuity of the system during the course of building construction and DLP. The results of these tests shall be by the Contractor's installation Professional Engineer compiled in report prepared by the Contractor.

The Contractor shall supply facilities for the recording of the test results referred to above, arranged in such a manner that comparisons can be readily made with earlier readings.

The Contractor shall submit a detailed layout drawing showing the positions of testing carry out on site.

The record sheet and layout drawing shall be kept on site at all times during the course of construction.

The Contractor shall carry out monthly inspection on the lightning protection system including the earthing pits to ensure that the system is in good working order

15.18 LIGHTNING PROTECTION SYSTEM

15.18.1 GENERAL

The Early Streamer Emission Lightning Protection System, comprising of ESE Lightening Arrestor shall be provided at top of each Tower.

The Arrestor shall be mounted on 3" dia hot dipped galvanized pipe at least 5 meter from the top of the building.

The down conductors shall be 95 sqmm bare copper conductor which shall be installed as shown in drawings welded at basement with the Earth Connecting Point. Continuity shall be checked and recorded after each floor pouring.

Contractor should also include in his scope inspection by manufacturers authorized representative to ensure correct installation.

All metal work on or around the building must be bonded to the lightning protection network to avoid side flashing.

All materials used throughout the installation shall be either copper or copper based components which are corrosion resistant and compatible with the application.

conductors, earth termination network and bonding and shall be responsible to provide all the necessary accessories to integrate the system with the architectural finish of the building.

15.18.2 ELECTRONIC System Surge Protection

Electronic system surge protection shall be used for the, Incoming Main Power Supply:

A suitable protection should be installed in the main LV Panels.

The ESP shall be connected in parallel with the supply. ESP should be installed within the LV Panel by the panel assembler.

HRC Fuses shall be provided in the connecting leads as required by the Specialist.

ESP to have neutral earth warning light, to detect if there is excessive voltage present between neutral and earth.

Protection shall be tested in accordance with the requirement of:

- BS6651 : 1999 'Protection of Structures against lightning' (Appendix C).
- BS2914 :1972 'Specification for surge diverters for alternating current power circuits'.
- IEEE C62.41 – 1991 'Recommended practice on surge voltage in low voltage AC Power circuits.'

The protector must not interfere with or restrict the system normal operation. It should not:

- Corrupt the normal mains power supply.
- Break or shutdown the power supply during operation.
- Have an excessive earth leakage current.
-

The protector shall be rated for a peak discharge current of no less than 10 KA (8 / 20 microsecond waveform) between any two conductors (phase to neutral, phase to earth, neutral to earth).

The protector shall limit the transient voltage to below equipment susceptibility levels. Unless otherwise stated, the peak transient let-through voltage shall not exceed 600 volts. For protectors with a nominal working voltage of 230 or 240 volts, when tested in accordance with BS 6651 :1999 Category B – High (6 kV 1.2 / 50microsecond open circuit voltage, 3kA 8/20 microsecond short circuit current).

This peak transient let through voltage shall not exceed for all combinations of conductors:

- Phase to neutral
- Phase to earth.
- Neutral to earth.

Mains protectors (installed in shunt / parallel) should have continuous indication of its protection status and the presence of power. Status indication should clearly show per phase.

- Full protection present.
- Reduced protection – replacement required.
- No protection – failure of protector.

The status indication should warn of protection failure between all combinations of conductors, including neutral to earth. (Otherwise a potentially dangerous short circuit

between neutral and earth could go undetected for some time). This should include early warning of excessive neutral to earth voltage.

The protector shall be supplied with detailed installation instructions. The installer must comply with the installation practice detailed by the protector manufacturer.

Protection for Data Communication and Telephone lines

1. Transient overvoltage protectors shall be installed on all data communication / signal / telephone lines entering or leaving the building, in order to protect equipment connected to the line, against transient overvoltages. (Where data lines travel between buildings linking equipment in each building, transient overvoltage protectors should be installed at both ends of the line in order to protect both pieces of equipment).
2. Protectors shall conform to
BS6651 : 1992 Protection of structures against lightning (Appendix C)
CCITT LX K17
3. The protector must not impair the systems normal operation. It should not :
 - Restrict the system bandwidth or signal frequency.
 - Introduce excessive inline resistance.
 - Cause signal reflections or impedance mismatches (on high frequency systems).
 - i. The protector will have a low transient 'let – through' voltage for tests conducted in accordance with BS6651 : 1992 Category C – High (5kV 10/700 microsecond test).
 - ii. This 'let – through' performance will be provided for all combinations of conductors:
 - Signal line to signal line.
 - Signal line to screen / earth.
4. The protector shall be rated for a peak discharge current of 10kA.
5. The protector shall be supplied with detailed installation instructions. The installer must comply with the installation practice detailed by the protector manufacturers.
6. The protector manufacturer should allow for the facility to mount and earth large numbers of protectors through an accessory combined mounting and earthing kit.

15.19 PUBLIC ADDRESS SYSTEM

15.19.1 GENERAL

The Contractor shall allow for the supply, installation, testing and commissioning of a Back-ground Music / Public Address system comprising of Amplifiers, loud speakers and all necessary cabling and termination which shall comply with the requirement of

the Local Authority. The system shall be generally as indicated on the drawings and as herein specified, to the approval of the Engineer.

The complete system shall be supplied by a specialist Subcontractor having at least 5 years' experience in the field. All equipment supplied shall be from one reputed manufacturer and shall be installed by the authorized representative of the manufacturer. All the equipment included in this system shall be covered by manufacturer's warranty for minimum five years.

For the purpose of Public Address System the speakers are grouped into different zones as follows;

- a) Corridors and Passage
- b) Retail
- c) Toilets
- d) Prayer Area
- e) Parking

Different level of priorities as per following shall be allotted to different signals for transmission through same speaker.

- | | |
|----------------------------|------------------|
| a) Emergency announcements | Highest priority |
| b) Fire tone | Next |
| c) Music | Least |

All control consoles shall be placed in the Control / Management Room. Announcement shall be played from the Control / Management Room.

The announcement shall be made in individual mode (i.e one zone at a time) or to multiple zones at a time.

The SOP can vary subject to the requirement of Chief Operating Officer. This shall be specified at the time of Completion of Commissioning and is included in part of vender software and hardware programming.

15.19.2 AMPLIFIER RACK

The amplifiers and associated equipment shall be housed in a standard 19" rack with plexi-glass door, located as shown on drawings. Ventilation panels shall be provided between every amplifier mainframe for proper air circulation and cooling. Proper exhaust fans shall be provided to achieve proper ventilation.

15.19.3 Amplifier Mainframe

The amplifiers shall be of modular construction with preamplifiers pluggable onto a mainframe. Upto ten preamplifiers could be added as required providing microphone, line, alarm tones, etc. Control over the total mainframe shall be achieved through audio monitoring combiners. The motherboard shall also be capable of accepting switch selectable pre-announcement chimes.

The power rating of the amplifiers shall be 160 watts, 320 watts or depending on the loudspeaker load requirements. No amplifier shall be loaded more than 80% of its rated capacity. Slave amplifiers shall be used to meet additional power requirements.

The amplifiers shall have the following technical characteristics:

Output power	240W/120W
Nominal RMS	100 W or 200W
Long Term Power	(100V) 160W
Output Voltage	100V
Frequency Response	60 Hz - 20,000 Hz
Speaker Outputs	6/8 Ohms
Inputs	2: Paging / BGM
THD @1 KHz.	<1%
SNR	=74dB
Sensitivity	-10dBm, 245m Volts
AC Input	220V, 50 Hz
Operational temperature	-20 to 45 deg C
Separate Tone Control	Bass and Treble

15.19.4 MICROPHONE INPUT MODULE

The module shall be a basic general purpose low impedance balanced microphone input, with a selectable phantom power facility. Output shall be available on bus and individually, separate bass and treble control and also relay controlled priority shall be available

It shall have the following specifications:

Input impedance	:	-60dB (775uV)/200 Ohms maximum.
Frequency response	:	30Hz and 20 kHz 0.5dB.
Output	:	0dB/47k
Signal/noise ratio	:	55dB max. sensitivity, 150 Ohms source
Bass Control	:	15dB at 50 Hz.
Treble Control	:	15dB at 15 KHz.

Distortion : < 0.1% at nominal output 1 kHz, max. sensitivity

15.19.5 BALANCED LINE INPUT MODULE

The balanced line input module shall be a general purpose balanced 600 Ohm input with relay controlled priority.

It shall have the following specifications:

Input Aux	:	-10dB (245mV) /10 K Ohm
Output	:	0dB / 47 K.
Input impedance	:	15k Ohms (300mV), 100k Ohms (100V).
Frequency response	:	30 Hz to 20 kHz
Bass Control	:	15dB at 50 Hz.
Treble Control	:	15dB at 15 kHz.
Distortion sensitivity	:	<0.1% at nominal output 1 kHz, max.

15.19.6 MIXER AMPLIFIER

The local amplifiers for the meeting rooms shall be rated 240W to drive the loudspeakers in the area. It shall be a full feature integrated amplifier with two mixable inputs, front panel activity indicators, integral fault monitoring, bass and treble control and shall be rack mountable. It shall be possible to add slave amplifiers for additional power requirements.

The amplifier shall have the following characteristics:

Input	:	220 / 240V, 50 Hz
Output regulation	:	<2dB
Distortion	:	<1%
Frequency response	:	60 Hz-20 kHz
SNR	:	74dB
Sensitivity Input	:	-10dB (245mV) 47K Ohms.
Power rating (Nominal)	:	240W or as per manufacturer requirement and engineer's approval

15.19.7 LOUDSPEAKERS

Loudspeakers shall be installed in the areas to achieve a uniform sound pressure level. The loudspeakers shall be mounted on walls, ceiling or in ground to meet the site requirements. All Parking/External area loudspeakers shall be weatherproof type. Speakers shall only be from the same equipment manufacture.

All loudspeakers shall have 100V line transformer to match 100V amplifier outputs.

The loudspeakers, including horns if used, shall provide music quality reproduction with a frequency response up to at least 18,000 Hz.

The specified power ratings of the speakers are the maximum values and no speaker is expected to be tapped at the maximum rating.

15.19.8 SOUND PROJECTORS

The sound projectors shall be used for landscape areas. It shall have a frequency response of 150 Hz-16 kHz and a maximum power rating of 30 watts.

The transformer shall have tapings of 15, 8, 4.0 and 2 watts at 100 volts. The SPL shall be 92dB, 1watt, 1m and the dispersion angle shall be at least 150 deg.

The speaker shall be dual cones wide band silicon treated.

The speakers shall be of weatherproof construction in aluminium alloy extruded body and front grill shall be perforated aluminium, with fixing brackets for angled positioning.

15.19.9 CEILING MOUNTED LOUDSPEAKER

The ceiling loudspeaker shall include a 180 mm high compliance loudspeaker, 100 volt transformer and baffle.

The loudspeaker shall have a dispersion angle of 140 deg, a frequency response of 100 Hz – 18 kHz and a maximum power rating of 6 watts. The SPL shall be 90dB @ 1W, 1M.

The transformer shall have power tapping of 6, 3, and 1.5 watts at 100 volts.

The speaker shall be dual cones wide band silicon treated. The same speaker shall also be suitable either for public areas or humid and steamed rooms.

The baffle shall have a diameter of 180mm and be finished in baked white enamel with a sculptured modern contoured shape. Construction shall be of welded steel to prevent vibration and rattle.

The speaker shall be white RAL 9010 epoxy coated with all aluminium grill and chassis to withstand to avoid corrosion.

The baffle shall utilize a torsion spring fixing for installation with mounting ring.

15.19.10 COMPACT CABINETS (W/P)

The weatherproof compact cabinet shall have a frequency response of 100 Hz-18 kHz and a maximum power rating of 16, 8, 4 or 2 watts as required for the area to be covered. The SPL shall be 92dB, 1 Watt, 1m.

The speaker shall be dual cones wide band silicon treated.

The construction shall be of moulded ABS plastic with aluminium grill and shall be black in colour. The unit shall include fixing brackets for angled positioning.

SPHERICAL SPEAKER

The spherical speaker shall be an omni-directional speaker, which shall be white in colour and manufactured of ABS plastic. Mounting shall be via a Pendant and the speaker shall be supplied with a metal braided cable.

Rated Power	:	6-20Watts
SPL@1m, 1 Watt	:	94dB
SPL@ Full Power,1m	:	107dB
Dispersion	:	140 (Vertical), 360 (Horizontal) Degrees
Dimensions	:	368 x 98 x 90mm
Frequency Range	:	80 – 18 kHz

INTEGRATION

Emergency Voice Evacuation system shall be integrated with Fire Alarm system and Building Management system for sequential operations and status monitoring.

Functions:

- During normal conditions, these systems play music in common area and can be used to page people and to make public announcements.
- In case of fire, a signal from fire alarm panel shall initiate announcement of pre-recorded message in all the groups/zones. This has the highest priority.
- To avoid panic in the entire building, manual announcements shall be made to be restricted to the affected areas through the PA system.
- If any additional hardware is needed, it should be specified and given with the software.

15.20 FIRE ALARM SYSTEM

15.20.1 GENERAL

15.20.2 RELATED DOCUMENTS

Manuals, brochures, technical submittals and general provisions of the Contract, including general and supplementary conditions, apply to this Section.

15.20.3 SUMMARY

This section includes the intelligent addressable fire alarm and detection system for ensuring safety and asset protection.

SUBMITTALS

Submit the product information for approval and final documentation in the quantities listed.

Documents for Approval:

1. Bill of material
2. Technical specifications of all the material
3. Connectivity diagrams
4. Any variance (in case of deviation from the given specifications)

Final Documents: Record documentation to include:

1. Documents listed above.
2. Recommended spare parts list for start-up support
3. Instruction manual
4. Testing Certificates

15.20.4 QUALITY ASSURANCE

Manufacturer Qualifications: Engage a firm with at least 15 years' experience in manufacturing fire alarm detection system.

Supplier is to have a local service team with available spare parts in Lahore, Pakistan.

Service personnel are to have at least 10 years in the installation, start-up and servicing of the said system.

The manufacturer's standard warranty shall in no event be for a period of less than 36 months starting from beneficial use of the equipment. Submittals received without written warranties as specified will be rejected in their entirety. Maintenance during reliability period shall also be covered in the warranty section.

15.20.5 PART 2- SCOPE OF WORK

GENERAL

The contractor shall supply and test the complete fire alarm system as described herein and as shown on the plans. The system shall include Intelligent Addressable main control panel, Addressable smoke sensors, Multi/heat sensors, wiring, termination, electrical boxes, and all other necessary material for a complete operating system.

The supplier has to verify that complete installation shall confirm to the applicable sections of NFPA-72, NFPA-71, EN-54 and BS-5839.

The fire alarm system shall allow for loading and editing instructions and operating sequences as necessary. The system shall be capable of storing, and downloading while the system is in operation, a second set of operating software resident in the control panels as backup in case primary operating software is corrupted. In addition, the system shall be capable of on-site programming to accommodate system expansion and facilitate changes in operation. All software operation shall be stored in a non-volatile programmable memory within the fire alarm control unit. Loss of primary and secondary power shall not erase the instructions stored in memory.

Resident software shall allow for full configuration of initiating circuits so that additional hardware shall not be necessary to accommodate changes in, for instance, sensing of normally open contact devices to sensing of normally closed contact devices or from sensing of normally open contact devices to sensing a combination of current limited and non-current limited devices on the same circuit.

The system shall have the capability of recalling alarms and trouble conditions in chronological order for the purpose of creating an event history of 600 events.

The activation of any system smoke detector shall initiate an alarm verification operation whereby the panel will reset the activated detector and wait for a second alarm activation. If within one minute after resetting, a second alarm is reported from the same or any other smoke detector, the system shall process the alarm as described in the sequence of operation. If no second alarm occurs within one minute the system shall resume normal operation. The Alarm verification shall operate only on smoke detector alarms. Other activated initiating devices shall be processed immediately. The Alarm verification operation shall be selectable by zone.

A manual evacuation switch shall be provided to operate the alarm indicating appliances without causing other control circuits to be activated. However, should a true alarm occur, all alarm functions service conditions including the time of each occurrence.

The system shall have a single key that will allow the operator to display all alarm, troubles, and supervisory service conditions including the time of each occurrence.

The system shall have provisions for disabling and enabling all circuits individually for maintenance or testing purposes.

The system batteries shall be supervised for disabling and enabling all circuits individually for maintenance or testing purposes.

The panels shall be capable of networking up to 99 more nodes as nodes as and when required without modification of hardware except adding network cards.

15.20.6 SEQUENCE OF OPERATION

Upon actuation of any manual station, or automatic detector or sprinkler flow switch, or air conditioning and ventilation duct return and exhaust air smoke detector. The system is to operate as follows:

On the Main Panel the green normal LED is to extinguish and the red alarm LED is to light. The first line is to display the user specified message indicating the floor and zone that initiated. The first line is to display the user specification message indicating the floor and zone that initiated the alarm. The second line of the LCD is to indicating real time, number of messages waiting, type of alarm, zone of alarm and time the alarm occurred. Red LED corresponding to the zone in alarm in the main panel shall also be lit.

The alarm indicators on the FACP and repeater panel to continue to flash until the alarm is acknowledged . If a subsequent alarm is received after acknowledgment, the alarm is to sound again. The operator is to acknowledge the alarm by pressing a dedicated button and the buzzer is to silence provided that isn't an additional alarms the operator is to acknowledge all pending alarms before the buzzer is to silence. To reset the system the device is to be cleared first then the reset button is to be pressed.

The alarm shall consists a "slow whoop" alarm tone, for ten second. The tone shall repeat continuously (unless manually silenced) until the alarm initiating device is restored to normal and system reset. The silencing of an alarm condition is not to prevent the resounding of alarm devices if a subsequent condition occurs. A time delay feature is to be provided to sound a general evacuation alarm automatically throughout the building if the initiating alarm condition is not responded to within a predetermined time. Visual indication at the panels, corresponding to activated voice alarm circuits is to illuminate.

15.20.7 VOICE COMMUNICATION (OPTIONAL)

A central single channel digital audio control module shall be provided for the necessary alarm message / tone generation main and remote microphone connections, music inputs, and mixer / pre-amplifier circuits. Continuous supervision shall be provided along with specific information as to the type of failure should a problem occur (e.g. Main microphone trouble, tone trouble, etc.) Audio outputs shall have individual gain control.

A hand-held push-to-talk microphone shall be provided in the Voice Command Centre, recessed within a protective panel-mounted enclosure. The microphone shall be a noise-cancelling communication type with a frequency range of 200 Hz and shall be equipped with self-winding five foot coiled cable. An LED indicator shall be provided for the circuits ready for transmission. The microphone shall be supervised for disconnection.

Digital tones for alarm (show whoop) and auxiliary requirements (wail, horn, chime, etc.) shall be provided.

A pre-recorded digitized voice message capability is to be provided for automatic transmission to building occupants during alarm conditions. The automatic message player shall not rely on a tape or other mechanical means of transmitting the evacuation message. A standard evacuation message shall be provided under this contract, however, the message player must be capable of transmitting a custom message of up to five (5) minutes long. A self-contained speaker will provide testing of the message (s) without disturbing the occupants of the facility.

The system shall be configured to allow selective voice paging. Upon activation of any speaker manual control switch, two attention getting beeps shall sound over the speakers indicating an impending voice message will occur.

If any speaker manual control switchers are activated, the control panel operator shall be able to make announcements via the push-to-talk paging microphone over the pre-selected speakers.

Facility for total building evacuation and paging shall be provided to allow for activation of all speakers. This shall be accomplished by the means of an "All Circuit" switch.

15.20.8 POWER REQUIREMENTS

The system shall be provided with sufficient battery capacity to operate the entire system upon loss of normal 230VAC power in a normal supervisory mode for a period of 24 hours with 30 minutes of alarm operation at the end of this period. The system shall automatically transfer to the stand-by batteries upon power failure. All battery charging and recharging operations shall be automatic. Contractor shall submit standby and alarm power calculations in support of the selected battery size. The batteries used for the system shall be maintenance free type.

15.20.9 FIRE ALARM CONTROL PANEL

The control panel shall be Intelligent Addressable type of adequate point capacity with 20% spare and the construction shall be modular with solid state, microprocessor based electronics. It shall display only those primary controls and display essential to operation during a fire alarm condition.

A local audible device shall sound during alarm, trouble or supervisory conditions. The audible device shall sound differently during each condition.

The following primary controls shall be visible through a front access panel:

- Eighty character liquid crystal display.
- Individual red system alarm LED.

- Individual yellow supervisory service LED.
- Silent Walk test with History Logging

The system shall be capable of being tested by one person. While in testing mode the alarm activation of an initiating device circuit shall be silently logged as an alarm condition in the historical data file. The panel shall automatically reset itself after logging of the alarm. The panel shall also be capable of giving an alert alarm in case if any addressable device is not in operation or requires maintenance.

LED Supervision

All slave module LEDs shall be supervised for burnout or disarrangement. Should a problem occur the LCD shall display the module and LED location number to facilitate location of that LED.

System Trouble Reminder

Should a trouble condition be present within the system and audible trouble signalsilenced, the trouble signal shall resound at pre-programmed time intervals to act as reminder that the fire alarm system is not 100% operational. Both the time interval and the trouble reminder signal shall be programmable to suit the owner's application.

15.20.10 MULTIPLE ADDRESSABLE PERIPHERAL NETWORK

The system must provide communication with initiating and control devices individually. All of these devices will be individually annunciated at the control panel. Annunciation shall include the following conditions for each point:

- Alarm
- Trouble
- Open
- Short
- Device missing/failed
- Automatic environmental compensation.
- Variable Sensitivity setting
- Day & Night mode of operation
- Automatic dirty sensor indication

All addressable devices shall have the capability of being disabled or enabled individually.

Each loop to have a minimum capacity of 200 devices with detector & control modules in any combination. System that require factory reprogramming to add or delete devices are unacceptable. Each loop to have 25% spares available. Vendor to increase the no. of loops, if required.

Each addressable device must be uniquely identified by an address code interred for each device. The use of jumpers to set address will not be acceptable due to the potential of vibration and poor contact. The system must verify that proper type device is in place and matches the desired software configuration.

15.21 PART 3 - ADDRESSABLE DEVICE TYPES

15.21.1 GENERAL

The system control panel must be capable of communicating with the types of addressable devices specified below. Addressable Devices will be located as shown on the drawings. The system shall identify when a smoke sensor becomes too dirty to operate properly. It shall also identify sensors which are almost dirty which need cleaning before they drift beyond their selected sensitivity. In short, a review of the front panel display or the printed status report quickly identify sensor that need cleaning.

Sensitivity of the sensor shall a programmable, photoelectric shall be variable from 0.2 to 37 percent and ionization sensitivity from 0.5 to 1.7 percent. It shall also be possible to programme for timed, automatic sensitivity selection such as less sensitive during working hours and more sensitive when quite.

The panel shall provide the following features:

- Individual sensitivity selection for each sensor
- Peak value logging allowing accurate analysis for sensitivity selection
- Automatic, once per minute individual; sensor calibration check to verify sensor integrity
- Display of sensitivity directly in per cent per foot
- Multi-stage alarm operation
- Ability to display and print detailed sensor information

15.21.2 Addressable Sensor Bases

The addressable sensor bases shall contain integral addressable electronics that constantly monitor the status of the detachable photoelectric, ionization or heat sensors. Each sensors output shall be digitized and transmitted to the control panel every four seconds.

It shall be possible to use different sensor types with the same base. The base shall have integral LED for power-on (pulsing), or alarm or trouble (steady on). The bases shall be available with connections for remote LED alarm indicator or connections for supervised remote replay. The sensor bases shall be size not more than 125mm diameter.

Address of the device shall be set in the base using dip switches so that removal or replacement of the sensor head will not affect the operation of the system. Device addressed through software or address set in the sensor head are not acceptable. Soft addressable sensors are also will be acceptable subject to compliance with other requirements of the specifications.

15.21.3 Addressable OPTICAL Smoke Sensors

Optical sensor shall use a stable, pulsed infrared LED light source and a silicon photodiode receiver to provide consistent and accurate low power smoke sensing. Seven levels of sensitivity shall be available for each individual sensor, ranging from 0.2% to 3.7% per foot of smoke obscuration. It shall be possible to select and monitor the sensitivity at the control panel.

The head be designed to allow 360 deg. Smoke entry for optimum response to smoke from any direction. A built-in screen shall keep insects from entering the smoke chamber.

15.21.4 Addressable Optical Heat Sensor

The addressable type heat sensor shall be self-restoring and provide a combination of rate and fixed temperature rate compensated sensing. It shall have low thermal mass to accurately and quickly measure the local temperature at the fire alarm panel.

It shall be possible to select the rate of rise temperature detection for either 15 °F or 20 °F per minute. Fixed temperature sensing and shall be programmable to operate at 135 °F or 155 °F. It shall be possible to program these sensors as a utility device to monitor for temperature extremes in the range from 32 °F to 120 °F (optional).

15.21.5 INTELLIGENT OPTICAL MULTI SENSOR

The Addressable Multi Sensor gathers analog information from one photoelectric fire sensing element and one heat sensing element and converts it into digital signals. The sensitivity of the Device shall be variable. The Addressable code for the Device shall be electronically programmed and stored in the Sensor and be non-volatile. The programming of this code shall be facilitated by a digital electronic hand held Device.

- Sensitivity variable
- Operating voltage 24VDC

- Standby Condition $\leq 100\mu\text{A}$
- Alarm Condition $\leq 7\text{mA}$
- Transmission Method Digital Communications
- Maximum Humidity 93% RH- Non Condensing (at 40°C)
- Temperature range -10°C - + 50°C
- Smoke Sensing Element: Photoelectric - Light Scattering Principle
- Heat Sensing Element: Fixed temperature alarms at 135°F (57°C) ambient

15.21.6 ADDRESSABLE PULL STATION

They shall be manufactured from high impact red lexan. Station shall mechanically latch upon operation and remain so until manually reset by opening with a key common to all system locks. Pull stations shall be double action type requiring smashing glass and pulling a lever to initiate an alarm.

The device shall integral electronics for constantly monitoring the status of the device and communicating the same to the control panel. Address of the device shall be set by dip switches in the associated electronics.

15.21.7 ADDRESSABLE DEVICE SUPERVISION

All devices shall be supervised or trouble conditions. The system control panel will be capable of displaying the type of trouble condition (open, short, device missing, failed).

Should a device fail it will not hinder the operation of other system devices.

15.21.8 NOTIFICATION APPLIANCES

Notification appliances shall include visible, audible or Audible / visible as shown in the drawing. Audible appliance shall be loudspeaker or dc vibrating bells and the visible appliance shall be strobes. The sounders must be capable of projecting the pre-recorded voice messages. The pre-recorded messages shall be in various languages i.e English , Urdu or any other as specified by the end user.

15.21.9 STROBES WITH SOUNDER (SINGLE UNIT)

Strobes shall be suitable for wall or ceiling mounting as shown in the drawings. Xenon flash tubes shall be 24VDC powered from the panel. Visible output shall be 30 candela. The reflective design shall provide light output in key axis directions allowing vertical or horizontal mounting. The unit shall be of red finish with white "FIRE" lettering . Flash rate shall be 1 Hz.

15.21.10 INTEGRATION

Fire Alarm system shall be integrated with Emergency Voice Evacuation system, Access control system and Building Management system for sequential operations and status monitoring.

15.22 CONDUIT SYSTEM, CABLE TRAY, CABLE LADDER AND TRUNKING INSTALLATION

15.22.1 GENERAL DESCRIPTION

This section describes the supply and installation of wiring facilities systems include conduits, cable trays, cable ladder and trunking system, c/w associated fittings and accessories.

All cables run above the suspended false ceiling, concealed in walls, columns, below slabs or on surface shall be supported by conduits, cable tray, dura duct trunking or cable ladder system. No free slinging cable is allowed.

The cable routes as shown in the drawings shall be used as a guide only. Prior to the installation, the cable routes shall be coordinated with other services. Uncoordinated and inaccessible routes after other services are installed, shall be relocated at the expense of the Contractor.

All conduits, trunkings, cable trays and cable ladders shall be earthed in accordance to BS7671 & BS7430.

All Telephone and Data Cabling shall be contained within cable containment as specified in this specification.

15.22.2 STANDARDS

The complete wiring facilities system shall be manufactured, supplied, installed and tested in accordance with the latest revision of the following standards and the appropriate BS/IEC include:

i. Steel Conduit and Fitting Accessories	BS4568 & BS731
ii. PVC Conduit and Fitting Accessories	BS6099 & BS4607
iii. Cable Tray	BS729
iv. Cable Ladder	BS729
v. Cable Trunking	BS4678

The complete wiring facilities system shall also conform to the requirements of all relevant local codes, as applicable, together with the additional requirements referred to

in this Specification and Drawings, whichever is the more stringent and acceptable to the Engineer.

In the adoption of standards and requirements, the Contractor shall take the following precedence:

- i. Engineer's decision;
- ii. Local codes of practice;
- iii. Drawings;
- iv. Specification;
- v. International standards and requirements

SUBMISSIONS

All technical submissions shall be approved by the Engineer prior to the respective stages of construction.

1. Routing of installation
2. Sample with proprietary factory-made accessories, elbows, risers, reducers, tees, crosses, etc.

PRODUCTS

15.22.3 Steel Conduit and Accessories

- Steel Conduit
 1. Conduits shall be of heavy gauge steel conforming to British Standard. They shall be solid drawn or seamed by welding. Both ends of the conduit shall be screwed.
 2. Conduits shall show no appreciable unevenness and their interior and ends shall be free from burrs, fins and the like which may cause damage to cables. Removal of any rough internal edges shall be made by a reamer rather than any tools that comes to hand.
 3. Conduits used for the project shall be galvanized to Class 4 type of BS 4568: 1970 and be approved reputable manufacturer. Adequate protection against corrosion shall be applied to both conduit interior and exterior.
 4. Flexible conduits used for equipment that subject to vibration such as pump, motor, etc. shall be of mild steel complying with BS 731:Part 1:1952. All flexible conduits shall be PVC covered. Low smoke zero halogen materials covered for installation within false ceiling.
- Fittings
 1. Samples of conduit fittings shall be submitted for approval prior to installation.

2. Fittings shall be those intended for use with screwed conduits and shall comply with BS 4568: Part 2:1970. However, bends, elbows and tees shall not be installed.
 3. Boxes and cover plates that are installed outdoors shall have fixing lugs exterior to the box so that fixing screws do not enter the box interior.
 4. Adaptors used with flexible conduits shall conform to BS 731: Part 1:1952.
- Circular Boxes
 1. Circular boxes shall be of malleable cast iron, galvanized and of standard pattern with spout(s). When used for connecting lengths of conduits, circular boxes shall be provided with cover plates of similar make that are complete with brass fixing screws.
 - Rectangular Boxes
 1. Rectangular boxes (adaptable boxes) shall be of mild steel not less than 2.4 mm gauge and galvanized. When used as junction boxes, lids of the same gauge with brass fixing screws shall be used.
 - Boxes for Accessories
 1. Boxes for accessories shall be suitable for surface mounting or recessed mounting according to the requirements. Surface mounted boxes and accessories shall be metal clad pattern. Recessed boxes and accessories shall be complete with insulated moulded type cover plates.
 - Covers

All covers for boxes, etc shall be made of galvanized steel of 1.2 mm thickness.

15.22.4 PVC Conduit and Accessories

PVC Conduit

1. Conduits shall conform to BS 6099: Part 1 and shall be heavy gauge of wall thickness of 1.9 mm rigid tubes which are unscrewed without coupling and with plain ends. All conduits used shall not be less than 25 mm diameter.
2. PVC conduit mounted outside building will not be accepted. PVC conduits shall not be used where liable to mechanical damage.
3. PVC conduit shall be used for all concealed installation.

PVC Conduit Accessories

1. Accessories used for conduit wiring shall be of an approved type complying to BS 4607.

2. All accessories used shall be of standard white or black colour, identical to conduit used.
3. Plain conduits should be jointed by slip type of couplers with manufacturer's standard sealing cement.
4. All conduit entries to outlet boxes, trunking and switchgear are to be made with adaptors female thread and male bushes screwed.
5. PVC-switch and socket boxes with round knockouts are to be used. The colours of these boxes and the conduits shall be the same.
6. Standard PVC circular junction boxes are to be used with conduits for intersection, Tee-junction, angle-junction and terminal. For the drawing-in of cables, standard circular through boxes shall be used.
7. Samples of accessories shall be submitted for approval prior to installation.
8. All jointing of PVC conduits shall be by means of adhesive jointing. Adequate expansion joints shall be allowed to take up the expansion of PVC conduits.

15.22.5 Conduit Installation

The whole conduit system shall be installed to comply fully with BS 7671.

Layout

1. The conduit layout and conduit routes shall be submitted for approval. Allowance for adjustments due to site conditions shall be provided with no extra cost.
2. Conduit routes shall be chosen for easy, straight runs with a minimum of bends and crossings. Generally they shall follow the structure of building, running at right angles or in parallel to floors and ceilings. Conduits shall be kept within 300 mm of floors and ceilings when running parallel to them.
3. Outlet boxes for housing accessories shall be used as draw boxes. The total number of draw boxes shall be kept to a minimum and shall be provided so that conduit runs do not exceed 12 m or have more than two right angle bends.
4. All conduits shall be kept clear of gas and water pipes. In particular, conduits shall be at least 150 mm away from gas pipes. Where proximity to these pipes is unavoidable, they shall be effectually segregated e.g. using rubber or other insulating material to prevent appreciable voltage differences at possible points of contact. Segregation from extra low voltage circuits and telecommunication circuits shall also apply unless these are wired to the same voltage requirements as lighting and power circuits.
5. Conduits from different distribution boards shall not be connected to the same junction box. Each run of conduit shall be assembled complete with draw-in-wires.

Joints And Terminations

1. Electrical and mechanical continuity shall be maintained throughout all conduit joints and terminations. Conduit threads shall be thoroughly cleaned and the conduits tightly screwed. The conduit system shall be watertight after installation.
2. Conduits shall be connected using coupler or via boxes. With a coupler, the ends of the conduit shall be butted close together and the running coupler is screwed tightly on and tightened by a locknut.
3. Conduits terminating into boxes provided with spouts shall be threaded so that there are no exposed threads. For boxes with no spouts, the termination shall be made using a brass bush and a coupler. The conduit is pushed through the knockout or drilled entry and the bush is screwed tightly onto its end. The coupler is screwed to butt firmly against the exterior wall of the box.
4. Where conduits are not jointed or terminated in boxes, they shall be terminated in a screwed brass bush.
5. In all joints and terminations, conduit threads shall not be exposed. Where this cannot be avoided as in a running coupler, the exposed threads shall be coated with red lead paint to seal against the ingress of water.

Bends

1. Conduits shall only be bent cold with an approved type of bending block or bending machine, without altering the dimensions of their sections.
2. All conduit bends shall be such as to permit compliance to the requirements for bends in cables to as stated in the BS 7671.
3. Bends shall be made with as large a radius as the position of the conduit within the building permits. Where the bend is more than 90 degree, circular or rectangular junction boxes are to be used for connecting conduits.

Cabling

1. The conduit system must be completely installed and free of obstructions and sharp corners before any cables are drawn in. Conduits shall be thoroughly swabbed to remove moisture and dirt immediately prior to the drawing in of cables.
2. Cables shall be drawn without crossing each other and shall not be pulled against the walls of the draw boxes. Slack cables shall left in all draw boxes.
3. Cables shall be continuous throughout conduit lengths and no joints are permitted. There shall be no kink in cables, neither any cut, abrasion or chink in the cable insulation.
4. The same conduit shall carry the lead and return conductors bunched together. However, the same conduit shall not house cables from different distribution boards.

5. Cables for power and lighting circuits and extra low voltage systems shall not be drawn into the same conduit. Lighting and power final circuits shall be run in separate conduits except, where an adaptable box is employed as final distribution point, a number of final circuits may be grouped together in larger conduits between the distribution board and the adaptable box provided that all final circuits in one conduit are of the same phase. In the case of three phase circuits, all three phases including neutral, if any, shall be drawn into the same conduit.
6. Conduits shall not constitute the earth continuity path for the electrical circuit. A separate circuit protective conductor shall be installed within the conduit. The whole conduit system shall be effectively earthed.
7. Flexible conduits shall also have a separate earthing conductor installed within the tubing and connected at conduit ends. Flexible conduits in general shall not be used for more than 3m length.

Access And Drainage

1. The conduit system shall be re-wireable, that is, draw boxes must be accessible for the purpose. Where boxes are concealed, their covers shall be flushed with the finished surface.
2. The need for accessibility notwithstanding, the conduit system shall be protected against the ingress of water and impurities. When installed, conduits shall be kept dry and free of debris with approved pipe plugs or caps. Such plugging is especially essential prior to pouring concrete for concealed installation. As for boxes, they shall be covered by steel plates prior to concreting.
3. When installed outdoor, and in situations liable to condensation of moisture, conduits shall be arranged to be self draining, so that water may drain to low points which are fitted with a drain plug. Conduits laid under concrete floors shall have watertight floor-traps of approved detail for access of these drainage points.
4. Conduits run on surfaces other than structural steel members shall be secured using galvanized space bar saddles and brass fixing screws. Spacing of saddles shall not exceed 1.2 m for conduit sizes up to and including 25 mm and 1.8 m for sizes 32 mm and above.
5. Conduits run on structural steel shall be secured using girder clips or an approved clamp. These conduits and those run in the vicinity of structural steel shall be bonded to the steelwork using an efficient and permanent metallic connection. The conduits shall not in any way be under mechanical stress.
6. All conduit boxes except loop-in patterns shall be fixed direct to the building structure in addition to the support provided by the conduits.

7. Conduits terminating into surface boxes shall be secured by a minimum of 3 saddles at not less than 32mm, 150 mm and 300 mm respectively from the box.
8. Conduits shall be painted with an approved paint to blend with visual environment. A zinc rich undercoat shall be provided before painting the final coat.

Cable Tray

- Cable tray shall be of perforated type and constructed a minimum 1.6 mm hot dipped galvanized mild steel for outdoor damp condition, and epoxy coated electro-galvanized mild steel for indoor installation. All cable trays shall be installed in a straight run parallel to walls where possible.
- Cable trays shall be supported by electro-galvanized 'U' channel with galvanized threaded rod for indoor suspended tray and hot-dipped galvanized for area subject to weather.
- All hangers shall be installed at 1 meter intervals and shall be primed and painted to match with the surrounding building finish approved by the Engineer.
- For cable tray that are exposed to the weather, a hot-dip galvanized covers of 1.5mm gauge steel, flush fixing type with gasket, shall be installed on top of the tray.
- Copper earth link bar shall be fixed at every joint of the cable tray run.

Cable Ladder

- All cable ladders and accessories installed indoors shall be heavy-duty epoxy coated electro-galvanized mild steel type. All cable ladders installed outdoors shall be heavy-duty hot dipped galvanized hot rolled mild steel to BS 729. Thickness of the mild steel shall not be less than 2 mm.
- Cable ladder shall have a 150 mm high longitudinal side member for ladders width of 800 mm or above and 120 mm high longitudinal side member for ladder width less than 800 mm.
- The rungs shall be at least 50 mm wide, with slots of 25 mm x 10 mm at 25 mm intervals covering the length of the rungs. The rungs shall be spaced at 300 mm apart along straight lengths of the ladder.
- All nuts, bolts and washers for clips and brackets shall be zinc plated. Each cable ladder shall be in standard manufacturers' length and supplied complete with coupling sets consisting of fishplates, spined bolts, nuts and locking washers.
- The complete cable ladder installation shall be provided with all necessary proprietary factory-made elbows, risers, reducers, tees, crosses, drop-outs, etc. and any site fabricated items will not be permitted.

- Separate flexible earth continuity connectors of at least 16mm² copper jumpers shall be installed between the ladder sections.
- All cables ladders shall be supported from the ceiling concrete slab, steel structures or sidewalls using a frame system similar to UNISTRUT, with overhead hangers, support channels, hanger rods or angle brackets, beam clams and ceiling brackets.
- Fixings and supports shall be installed at regular intervals not exceeding 1000 mm and 150 mm from all bends, tees, inter-sections and risers.
- When cable ladder is refined to install across structure expansion joints, the ladder shall be in two sections between supports installed on either side of the expansion joint.
- The ladder sections shall than be jointed with expansion joint fishplates, bolts, nuts and washers install in elongated holes permitting a lengthwise movement of 25 mm from the initial fastening position.
- For cable ladder that are exposed to the weather, a hot-dip galvanized covers of 1.5mm gauge steel, flush fixing type with gasket, shall be installed on top of the ladder.
- Copper earth link bar shall be fixed at every joint of the cable ladder run.

Cables Trunking

- Cable trunking shall be manufactured from 1.6 mm minimum electro-galvanized mild sheet steel to BS4678 finished in oven-baked electrostatically coated epoxy power coating with colour to the Engineer's choice.
- All trunking shall have removable lids extending over their entire lengths. Lids shall be fixed at interval not exceeding 1 meter by means of brass steel screws which and protected against corrosion by a finish of zinc coating or equivalent to zinc coating.
- Factory-made bends, joints, elbow, riser, tee, reducer and accessories with same material shall be provided throughout the installation for trunking.
- Trunking space factor shall be in compliance with BS7671.
- Copper earth link bar shall be fixed at every joint of the cable trunking run.

15.23 COOMUNICAITON CABLING

GENERAL

Work in this section includes supply, installation/laying , termination , testing , labelling , certification and commissioning of a high quality **Voice Communication Cabling Works** as per BOQ , drawings and technical specifications.

The Voice Cabling works shall comprise of:

Within general scope of works followings items should specifically be included in the scope of contractors.

- Co-ordinate the system engineering with electrical power supply arrangement, PABX and Communication Rack, Patch Panel etc. Detailed shop drawings shall be submitted before commencement of work or material procurement for client's and consultant's approval. Shop drawings shall include all horizontal and vertical cabling layouts , IT room layouts for com racks etc.
- After installing the works the contractor shall provide the equipment required to test the installation prior to the commissioning.
- The contractor will closely co-ordinate all other activities to coordinate with the structured cabling work.
- The contractor shall after completion of cabling works test all connections of entire work for connectivity and relevant variables , record all test results and provide within 30 days of completion of works a detailed test report and an original certificate by the equipment / cable manufacturer.
- Any material found not up to the required standard shall be immediately dismantled and / or removed from site by the contractor without claim extra payment.

Work not included in the scope of contractor :

- All active components like switches , servers etc.
- Server racks.
- PABX and its installation.
- Telephone sets.

15.23.1 TECHNICAL SPECIFICATIONS

The following checklist states the specifications and features of each individual item required for the structured cabling system.

15.23.2 Horizontal Cabling

The Horizontal cabling is the portion of the telecommunications cabling system that extends from the work station telecommunications outlet to the floor distributor / communication rack in the Communication rooms. It consists of the telecommunications outlet/connector, the horizontal cables, and that portion of the cross-connect in the telecommunications closet serving the horizontal cable. Each floor of a building should be served by its own Horizontal Cabling system.

15.23.3 Communication Cables

All UTP and fiber optic cables shall conform to ANSI/TIA/EIA-568-B Commercial Building Telecommunications Cabling Standard and ISO/IEC 11801 CLASS EDITION 2: 2002 CLASS E, AS/NZS 3080:2003 CLASS E(International) Generic Cabling for Customer Premises standard. The following cable specifications shall also be met by the cable manufacturer for 4-pair UTP Category 6 cables:

15.23.4 Category 6 UTP Cables

UTP cables must :

- Be provided by the connecting hardware manufacturer.
- Be 100 ohms 4-pair, Category 6 CM for horizontal and CMR rated for vertical backbone. Cable tested to 250 MHz and exceeds TIA/EIA 568-B Category 6, ISO/IEC 11801 Cable.
- Attenuation and Cross-talk at 100 MHz must be 19.8 db maximum and 44.3db minimum respectively. Average results not required.
- Attenuation and Cross-talk at 100 MHz must be 32.8 db maximum and 38.3db minimum respectively. Average results not required.
- Availability of a central cross filler made of PE for improved pair to pair noise isolation.
- Be appropriate for the environment in which it is installed.
- Meet the following mechanical specifications.

No. pairs	4
Conductor	23/24AWG solid copper.
Insulation Thickness	0.22mm
External sheath	Flame Retardant PVC
Sheath Color	Different for voice and data cables.
Sheathed Cable diameter	6.0mm
Operational Temperature range	-20o C to 60oC

- Meet the following Electrical Specifications

Characteristic Impedance	100ohms + 5 ohms
Minimum Phase velocity of Propagation	69%
Max. Conductor DC Resistance 20oC	73.2 ohms/km
Delay Skew	< 45 nanoseconds

15.23.5 Cable Routing

All horizontal cables, regardless of media type, shall not exceed 90 m (295 ft) from the telecommunications outlet in the designated Work to the floor distributor. The combined length of jumpers, or patch cords and equipment cables in the telecommunications closet and in the Designated Work Area should not exceed 10m (33 ft).

Horizontal pathways shall be installed or selected such that the minimum bend radius of horizontal cables is kept within manufacturer specifications both during and after installation.

Telecommunications pathways, spaces and metallic cables which run parallel with electric power or lighting shall be installed with a minimum clearance of 50 mm (2 in).

For voice or data applications, **UTP** or **fiber** optic cables shall be run using a star topology from the designated telecommunications closet on the respective specified floor to the respective individual information outlet. All cable routes shall be approved by the consultant prior to installation of the cabling.

The Contractor shall observe the bending radius and pulling strength requirements of the 4-pair UTP/ 25-pair and fiber optic cable during handling and installation.

Each run of UTP cable between horizontal portions of the cross-connect in the telecommunication closet and the information outlet shall not contain splices.

In the telecommunications closet where cable trays or cable racks are used, the contractor shall provide appropriate means of cable management such as reusable color coded cable managers (ties) to create a neat appearing and practical installation.

Continuous conduit runs installed by the contractor should not exceed 30.5 m (100 ft) or contain more than two (2) 90 degree bends without utilizing appropriately-sized pull boxes.

15.23.6 Modular Equipment Cord

Category 6 modular equipment cords shall :

- Be round, and consist of eight insulated 23/24 AWG, stranded copper conductors, arranged in four color-coded twisted-pairs within a CMR rated flame-retardant jacket.
- Be equipped with modular 8-position (RJ45 style) plugs on both ends, wired straight-through with standards compliant wiring.
- Have anti-snag feature provides maximum protection from snagging during moves and re-arrangements.

- Use modular plugs which exceed FCC CFR 47 part 68 subpart F and IEC 60603-7 specifications, and have 50 micro inches of gold plating over 100 micro inches of nickel contacts.
- Modular cords should include a strain relief boots.
- Be available in any custom length and standard lengths of 0.5, 1.0, 1.5, 2.0, 2.5, 3.0, 5.0 meters.

Electrical Specifications:

- be 100% transmission tested with laboratory grade network analyzers for proper performance up to 250 MHz. Vendor shall guarantee cords are compatible with Category 6 links.
- be UL VERIFIED for TIA/EIA Category 6 electrical performance.
- be UL LISTED

15.23.7 Voice Outlets / Information outlets

The RJ45 outlets shall be mounted on a double outlet wall plate in the color specified in the following section. The RJ-45 outlets shall be independently tested and verified to TIA/EIA 568-B.2-1 Category 6 performance as shown below.

Transmission Specifications (worst case – all pairs)

Frequency (MHz)	Insertion Loss dB	Pair-to-Pair NE) dB	Pair-to-Pair FEXT dB	Return Loss dB
1.0	0.1	- 75	- 75	- 30
4.0	0.1	- 75	-71.1	- 30
10	0.1	- 74	- 63.1	- 30
16	0.1	- 69.9	- 59	- 30
20	0.1	- 68	- 57.1	- 30
25	0.1	- 66	- 55.1	- 30
31.25	0.11	- 64.1	- 53.2	- 30
62.5	0.16	- 58.1	- 47.2	- 28.1
100	0.2	- 54	- 43.1	- 24
200	0.28	- 48	- 37.1	- 18
250	0.32	- 46	- 35.1	- 16

All information outlets for 100 ohms, 22-24 AWG copper cable must comply the following:

- Must utilize compliant pin technology 110-style insulation displacement connectors (IDC) which allows the use of a 4-pair impact tool.
- Must allow for a minimum of 200 re-terminations without signal degradation.
- Must allow for a minimum of 1000 re-insertions without signal degradation.
- Provide universal application / multi-vendor support.

- Support both industry standards for T568A or T568B wiring options.
- RJ-45 must have a flush face, zero footprint shutter mechanism to prevent dust ingress, insect infestation for areas having excessive airborne contaminants.
- Be constructed of high impact, flame-retardant thermoplastic, UL 94V-O rated.
- RJ-45 Jacks be available in White Electric, Soft Grey, Black, Green, Red, Yellow, Blue and Black Color.
- Be ANSI/TIA/EIA-568-B and ISO/IEC 11801 CLASS EDITION 2: 2002 CLASS E, AS/NZS 3080:2003 CLASS E Category 6 compliant.
- Flush-faced, zero footprints, shutter mechanism.

All faceplates shall :

- Accommodate either one/ two 8-conductor modular jacks.
- Be applicable to both fiber and copper applications.
- Have a swing cradle option pivoted on a grid assembly. Swing cradle shall be rotate up to 90 degree and provide multiple angles for reducing cable bending.
- Have write on designation labels for circuit identification together with a clear plastic cover.
- Accept up to 4 channel application identification icons per outlet.
- Must have option of faceplate surround offering all seven colors of the EIA/TIA 606 specifications to facilitate color coding.

Faceplate be made of flame retardant polycarbonate material.

15.23.8 INSTALLATION PROCEDURES

Prior to placing any cable, the contractor shall survey the site to determine job conditions will not impose any obstructions that would interfere with the safe and satisfactory placement of the cables, and to arrange the removal of any obstructions with the Project Manager accordingly.

- Pathways shall be designed and installed to meet **(state applicable local and national building and electrical codes or regulations)**
- Grounding/Earthing and bonding of pathways shall comply with **(state applicable codes and regulations)**.
- Pathways shall not have exposed sharp edges that may come into contact with telecommunications cables.
- The number of cables placed in a pathway shall not exceed manufacture specifications, nor, will the geometric shape of a cable be affected.
- Pathways shall not be located in elevator shafts.

- Horizontal distribution cables shall not be exposed in the work area or other locations with public access.
- Cables routed in a suspended ceiling shall not be draped across the ceiling tiles. Cable supports shall be mounted a minimum of 75 mm (3 in) above the ceiling grid supporting the tiles.
- Cable supports in a suspended ceiling shall be structurally independent of the suspended ceiling, its framework, or supports, and not be spaced more than 1.5 m (5 ft) apart.
- The installation of telecommunications cabling shall maintain a minimum clearance of 3 m (10 ft) from power cables in excess of 480 Vrms.
- No telecommunications cross-connects shall be physically located within 6 m (20 ft) of electrical distribution panels, step down devices or transformers which carry voltages in excess of 480 Vrms.
- Minimum separation of 50 mm (2 in) shall be provided in areas where power or electric light circuits which are equal to or less than 480 Vrms and telecommunications cabling coexist.
- All UTP cables wired to the telecommunications outlet/connector shall have 4-pairs terminated in eight-position, non-keyed modular outlets in the work area. All pairs shall be terminated.
- The telecommunications outlet/connector shall be securely mounted at planned locations.
- The height of the telecommunications faceplates shall be to applicable codes and regulations.
- The maximum cable pulling tensions shall not exceed manufacturer's specifications.
- The maximum cable bend radii shall not exceed manufacturer's specifications.
- In spaces with UTP cable termination's, the maximum bend radius for 4-pair cable shall not exceed four times the outside diameter of the cable and ten times for multi-pair cable. This shall be done unless this violates manufacturer specifications.
- During the actual installation, bend radius on 4-pair cable shall not exceed eight times the outside diameter of the cable and ten times for multi-pair cable. This shall be done unless this violates manufacturer specifications.
- In the work area, a minimum of 300 mm (12 in) should be left for UTP/ScTP, while 1 m (3 ft) be left for fiber cables.

- In telecommunications closets a minimum of 3 m (10 ft) of slack should be left for all cable types. This slack must be neatly managed on trays or other support types.
- Hook and loop fastener Wraps shall be used at appropriate intervals to secure cable and to provide strain relief at termination points. These wraps shall not be over tightened to the point of deforming or crimping the cable sheath.
- Hook and loop fastener Wraps should be used in the closet where reconfiguration of cables and termination's may be frequent.
- Properly installed fire stop systems shall be installed to prevent or retard the spread of fire, smoke, water, and gases through the building. This requirement applies to openings designed for telecommunications use that may or may not be penetrated by cables, wires, or raceways.
- The local fire safety code must be observed.
- All work shall be done in a workman like fashion of the highest standards in the telecommunications industry. All equipment and materials are to be installed in a neat and secure manner, while cables are to be properly dressed. Workers must clean any debris and trash at the close of each workday.

15.23.9 System Documentation/Shop drawings

After the award of work prior to supply/installation of any equipment the Contractor shall submit comprehensive System Documentation with shop drawings (in duplicate) of cable layout plan of each floor, after studying cable trunking plans (issued in the tender document), for the approval of the Engineer before executing the work.

The documentation package shall include:

- The marked-up floor plans/shop drawings showing outlet locations, associated numbering, DF locations, and major run paths and risers, schematics.
- A synopsis of the numbering scheme
- The cross connect log in hard copy and software based
- A list of major components and their place in the network
- Any ancillary supporting documentation

15.23.10 Numbering Scheme

An intelligent numbering scheme is to be used in the cable plant for identification of the cable. The numbering scheme may be based on the cable plant itself and not any technological or physical aspect of the building it supports. The numbering scheme breaks into three areas:

- Horizontal Cabling
- Backbone Cabling
- System equipment

15.23.11 Horizontal Cabling

Label each cable, user outlet, and patch panel (or punch block) with a designation developed to the following formula at each end of the run:

DF# - Group # - Channel

Where DF# is the terminating distribution frame the cable connects to (“00” typically designated the Building Distributor / MDF). Group # is sequential in each DF and typically represents a patch panel or punch block and Channel # is sequential within the group, as indicated by the logical or physical channel numbering on the components.

15.23.12 Backbone Cabling

Label each riser cable; user outlet and patch panel (or punch block) with a designation developed to the following formula each end of the run:

ODF# - TDF# - Cable# - Channel

Where ODF# is the distribution frame from which the cable originates, TDF# is the distribution frame in which the cable terminates, Cable # is sequential between each DF and Channel # is sequential within the cable, as indicated by the logical or physical channel numbering on the components. It is not required where the cable represents a single physical channel of communications.

15.23.13 System Equipment

Use the following designation formula for each piece of network equipment that is represented directly or through some type of patch panel:

Device# - Group# - Port#

Where Device# is sequential for each device in a DF, Group # is sequential in each device and represents a chassis card or other logical group and Port# is sequential within the group is indicated by the logical or physical channel numbering on the group components.

15.23.14 Cross Connect Log

As the final procedure in any network installation, the certified installer should provide a set of cross connect logs for each DF in the system. A cross connect log shall be simple hard copy and software-based log documenting the cross connections of rack

and wall mounted termination components (i.e., patch cables or cross wires). It follows a simple “from-to” format utilizing the numbering scheme to identify interconnecting ports.

A numbering/labelling scheme different from suggested above may be submitted.

15.24 Cabling

Cables shall be laid in already laid GI trunks / pvc conduits.

The Contractor's staff undertaking installation & termination shall be certified installers trained & certified by the manufacturer of structured cabling equipment.

Cabling shall be routed and installed at a sufficient distance from equipment and power cabling that may generate high levels of electromagnetic interference. Cables shall be laid without joints or splices (except where approved), stress-free with a minimum bend radius of at least 10 times the cable diameter, and shall be tied at regular intervals and dressed neatly. The twist of all cable shall be maintained as closely as possible to the point of mechanical terminations.

15.24.1 DATA SUBMITTALS

The following data must be submitted with the bid:

- Detailed technical literature and specifications with Make & model numbers of equipment offered (including all accessories) with BOQ item numbers clearly marked against each item.
- Contractor, where appropriate, will require to demonstrate the items detailed in the proposal. All these demonstrations/ presentation shall simulate actual environment. Contractor shall bear all cost of said presentations / demonstrations.
- A detailed list of compliance / deviations from contract conditions and technical specifications shall be submitted. If none is submitted it shall be assumed that there are no deviations.
- Any proposed changed in design / equipment shall be offered separately.
- Authorization certificate of the contractor as an agent to backup specified 25 years system performance warranty from manufacturer.
- Certificates of authorized installers from manufacturer certifying that contractor's personnel have been trained & certified for system installation.

15.24.2 TESTING PROCEDURES

Testing of cable channels shall be performed prior to system hand-over.

Copper Testing

- 100 % testing of the UTP horizontal cables and backbone cables whose length does not exceed 90 m (295 ft) in accordance to ANSI/TIA/EIA-TSB-67 for wire map, attenuation, length, NEXT (Near end crosstalk loss).

15.25 ADMINISTRATION DOCUMENTATIONS

Labeling

- Horizontal and backbone cables shall be labelled at each end. The cable or its label shall be marked with its identifier.
- A unique identifier shall be marked on each faceplate to identify it as connecting hardware.
- Each port in the faceplate shall be labelled with its identifier.
- A unique identifier shall be marked on each piece of connecting hardware to identify it as connecting hardware.
- Each port on the connecting hardware shall be labelled with its identifier.

15.25.1 As-Built Drawings.

As-built drawing shall be supplied by the contractor showing the locations of and identifiers for all :

1. Horizontal cable routing and terminations.
2. Telecommunications outlets/connectors

Backbone cable routing and terminations.

All records shall be created by the installation contractor and turned over at the completion of work. The format shall be computer based and both soft copies and hard copies shall be part of the As-built package. The minimum requirements include:

- Cable records must contain the identifier, cable type, length, termination positions at both ends, manufacturer, and part number.
- Connecting hardware records must contain the identifier, type of hardware and the amount of positions.
- Connecting hardware positions records must contain the identifier, type of position, and the cable identifier attached to it.

Test documentation on all cable types shall be included as part of the As-built package.

Reports

All reports shall be generated from the computer based program used to create the records above. These reports should include but not limited to:

- Cable Reports
- Cross-connect Reports
- Connecting hardware Reports

WARRANTY

System Warranty

At least 25 years Systems Warranty for Structured Cabling System shall be provided for an end-to-end Channel or Permanent Link Warranty which covers applications and components on all passive telecommunications equipment and cable.

Product Warranty

The manufacturer of passive telecommunications equipment used in a manner not associated with the Systems Warranty must have a minimum 20 year Component Warranty on all its product. The Products Warranty covers the components against defects in material or workmanship under normal and proper use.

Applications Supported

Applications supported include those approved by the Institute of Electronic and Electrical Engineers (IEEE), the Asynchronous Transfer Mode (ATM), the American National Standards Institute (ANSI) or the International Standards Organization (ISO) as of the date of registration. This would include but not limited to IEEE Std 802.3u-1995 100Base-T or IEEE Std 802.12-1995, Demand Priority or ATM Forum AF-PHY-0015.000 155 Mb/s over twisted-pair. Additional applications that are covered by this warranty include those under development on Gigabit Ethernet (IEEE 802.3z) and 622 Mb/s ATM that specify compatibility with the type of cabling installed.

15.25.2 CABLING STANDARDS

All Copper / Optical fiber cabling, components & connecting hardware shall be in accordance with the latest revision of the following standards:

ISO/IEC 11801
 ISO/IEC/TR3 8802-1
 ISO/IEC/8802-3
 ISO/IEC 61935-1
 IEC 60364-1
 IEC 60950
 EN50173
 EN50174-1
 EN50174-2
 ANSI/TIA/EIA-568 – 568B
 ANSI/TIA/EIA - 569

TIA/EIA TSB-72
 TIA/EIA TSB-75
 BICSI Telecommunication Method Manual
 IEEE 802.3

Category 6 components shall be able to support frequency upto 250 MHz, speeds upto 100 Mbps, 155 Mbps and gigabit applications.

15.26 PABX

Work Included

- General - The Contractor shall completely test and inspect all systems in accordance with the specifications and drawings. The Contractor shall certify that all systems are in complete working order prior to turning over to the Employer.
- All work shall be carried out in accordance with the requirements of the Pakistan Telecommunications Corporation Ltd. and it will be the responsibility of the Contractor to have the installation approved and passed by the PTCL, at no extra cost to the Employer.

Applicable Standards

The PABX shall be approved by the Pakistan Telecommunications Corporation Limited for connection to their network. It shall be the responsibility of the CONTRACTOR to obtain all necessary approvals and NOCs from the PTCL and the local exchange.

Submission

- All technical submissions shall be approved by the Engineer prior to the respective stages of construction.
- As a minimum requirement, the submission shall include the following:
 - i) Equipment submission with manufacturer's data.
 - ii) Shop Drawings showing the coordinated installation detail.
 - iii) Factory published specification sheet indicating standard and optional accessories, etc.

Product

The IP-PABX/Gateway shall have the following features:

- Cabinet design with plug-in modules and connecting cables.
- Integrated and discrete components of high level of quality and reliability to guarantee a high level of availability over extended usage period.
- Integrated security system which optimises system availability when faults occur, simplifies maintenance and enables automatic restart to take place if there is a power outage/ disconnection.

- Shall be capable of connecting the following types of trunks:
 - Incoming/outgoing/both way normal trunks.
 - Direct-inward-dialling (DID) lines
- Tie Lines
- (Signalling on the above may be Pulse or DTMF type).
- Stations may have Impulse or DTMF signalling.
- Suitability for data-signal switching.
- Modular expansion capability for incoming/outgoing lines.
- All facilities of modern PABXs shall be provided, including
- Extension to extension dialling
- Diversion
- Trunk Access
- Call transfer
- Extension Call pickup
- Operator Camp-on
- Music on hold
- Redialling system
- Special trunks
- Display panel
- Video Conferencing
- Cell phones, laptops & computers can be used as unique exchanges
- Power Supply with 2hrs battery back up
- Incoming (External) and outgoing (Extensions) can be extendable.
- Extendable type

Telephone instruments shall be of rugged ABS plastic of the push-button type, with radial and recall buttons, and adjustable bell volume/tone controls. Flexible incoming cable (3m length) and instrument cable shall be connected to the base with modular jacks. Colours shall be as chosen by the Employer/Consultant. The instrument shall be approved by PTCL and be compatible with the PABX.

Wiring shall be carried out in accordance with the requirements of the Pakistan Telecommunications Corporation Limited and it will be the responsibility of the Contractor to have the installation approved and passed by the PTCL, at no extra cost to the Employer.

The wiring shall be laid in concealed PVC conduits. External wiring shall be carried out in heavy-duty (Class D) PVC pipe, 500mm below grade, with hand holes 50m intervals or as required by site conditions.

To maintain system performance & compatibility, all equipment shall be of same make.

All equipment shall be new and of latest make & model.

The complete system hardware plus software shall be compatible to any protocol.

15.26.1 Installation

The Contractor shall prepare detailed shop drawings laying out the work, with comprehensive technical submittals in duplicate for the approval of the Engineer/Consultant. The final shop drawings & technical submittals shall be submitted in triplicate.

All installation and termination work shall be undertaken by the Contractor, under the supervision of a qualified Engineer who has been trained by the manufacturer.

Cables shall be laid by others under the supervision of contractor.

15.26.2 Testing

Complete planning, installation, and operating manuals/documentation shall be made available in triplicate to the Employer through consultant, and the Employer's security personal shall be trained in the operation, programming, and maintenance of the system.

15.26.3 GUARANTEE & MAINTENANCE

The Contractor shall provide an on-site warranty and free maintenance (1 visit/3 moths), covering materials and labour, valid for 1 year from date of commissioning, for the entire PABX system.

15.27 IP BASED CCTV SYSTEM

15.27.1 SCOPE OF WORK

The scope of the work includes the installation, testing and commissioning the complete CCTV system as described herein and as shown on the plans. The system shall include NVRs, PTZ cameras, Dome Cameras, Box type cameras, PTZ controller, LCD screens, wiring, termination, electrical boxes, and all other necessary material for a complete operating system.

15.27.2 FIXED DOME / BOX TYPE IP COLOUR DAY/NIGHT CAMERA

The fixed camera should have the following features:

- Directly IP based without requirement of encoder.
- Day / Night camera. Should switch automatically to monochrome mode (black and white) at night.
- Imaging Device 1/3 inch complementary metal oxide semiconductor (CMOS) or charge Coupled Device (CCD) with wide dynamic range (WDR)
- Image Control with Automatic white balance (AWB), automatic back light compensation (BLC), automatic gain control (AGC)
- Iris setting should be auto/manual with definitions for sharpness, image quality and also time stamp and camera ID.
- Minimum Illumination should be:
 - Color mode: F1.4 @ 0.1 lux (.01 fc)
 - Black and white mode: F1.4 @ 0.04 lux (0.004 fc)
- Vari-focal CS mount lens 3.5mm to 50mm required
- Supported Video Compression should be H.264 and Motion JPEG (MJPEG)
- 704 x 576 @ 25 fps PAL (minimum required)
- 1920 x1080 @ 25 fps PAL (maximum required)
- Should support dual Video Streaming with both streams originating independently from the camera
- Should support multicasting
- Should support Power over Ethernet (PoE) 802.3af
- Should provide at least two digital inputs and two digital outputs for hardwire integration.
- Camera should provide 802.1X authentication
- Camera should support at least 128 bit encryption using hardware-based Advanced Encryption Standard (AES)
- Multiple user access levels with password protection.

15.27.3 PAN/TILT/ZOOM DAY/NIGHT INDOOR/OUTDOOR COLOUR DOME CAMERA

The PTZ Camera should have the following features:

- The camera should be IP based.
- The camera should be true outdoor model suitable for use in Pakistan.

- It shall be a discreet camera dome system consisting of a dome drive with a variable speed/high speed pan/tilt drive unit with continuous 360° rotation.
- Imaging device should be 1/3 inch CCD and support both color and monochrome black and white. With 540 TVL horizontal resolution.
- Should provide 27x optical zoom and 12x digital zoom (minimum) with auto focus feature
- The camera should provide high-quality MPEG-4, MJPEG or H.264 compressed images.
- The camera should provide images @ 4CIF i.e. with a resolution of 704x576 pixels in PAL mode.
- The supported frame rate should be 30ips or 25ips in PAL mode.
- The camera should support two simultaneous streams
- Should support Day/Night mode and should switch automatically to monochrome mode at night with below 1 lux sensing at variable shutter speeds.
- Should provide super quick, 400° per-second pan and 200° per-second tilt speeds with 256 pre-set positions. Each pre-set position should support the programmable camera settings such including selectable auto focus modes, iris level, Low Light limit, and backlight compensation for each preset.
- Should support wide dynamic range (128x) appropriate for high contrasting environments
- Should support Automatic focus, automatic Iris control, gain control horizontal and vertical aperture control.
- Should be installed in a High-impact, weather-resistant dome enclosure
- Camera must provide at least 7 Inputs and 2 outputs that can be programmed individually. Inputs should be able to trigger an alarm condition. Outputs should be able to drive an external device.
- Should support intelligent privacy masking by providing 8, four-sided user-defined shapes, each side with different lengths; window blanking setting to turn off at user-defined zoom ratio; window blanking set to opaque gray or translucent smear; blank all video above user-defined tilt angle; blank all video below user-defined tilt angle .
- Should support at least 8 user-defined programmable patterns including pan/tilt/zoom and preset functions, and pattern programming through control keyboard or through dome system on-screen menu
- Should support a web interface utility for 5 simultaneous users when using MJPEG/MPEG-4 in uni-cast mode. When configured in multicast mode (MPEG-4), the camera should support an unlimited number of users.

- Should support On-screen display for time, date and location. The position of the display and text should be user definable.
- Should support On-screen display of compass heading and user-definable compass setup so as to indicate direction that the camera is looking in.
- Should support multi level password protection.
- Should support Secure Sockets Layer (SSL) 128 bit encryption

15.27.4 VIDEO MANAGEMENT AND RECORDING SYSTEM

The Video Surveillance Management platform should be optimized for applications to view, store, and manage real-time and recorded video in a networked environment. The system should use an open suite of URL-based programmatic interfaces to communicate with applications. The system shall provide a highly scalable and reliable platform to enable customized, network-based surveillance applications. The Video Surveillance Management platform shall include but not limited to the minimum of the following features/functions/specifications:

- The system shall display any combination of live and recorded camera feeds on multiple workstations simultaneously using an IP network.
- The system shall provide low latency video with high quality images and support H.264, MPEG-4, and Motion-JPEG compression schemes simultaneously.
- The system shall provide replication of individual video feeds at different frame rates for multiple users and other system processes.
- The system shall support simultaneous video feeds across multiple locations for centralized and decentralized storage, display, and distribution of video without limitation, but shall minimize load on video servers by streaming only the active video channels.
- The system shall be capable of streaming and recording video at different bit rates and variable frame rates up to full motion 25 fps (PAL) video on all camera feeds and shall support QCIF, CIF, VGA (640x480 pixels), D1 (720x576pixels) and 4CIF (704x576 pixels) camera resolution.
- The system shall provide the ability to remotely configure the cameras and shall allow configuration data to be imported from a spreadsheet.
- The system shall allow instant replay of video and will permit pausing of live video, forward and backward review of recorded video, and return to live viewing.
- The system shall manage storage of real-time video at any specified frame rate, duration, and physical location on the network.
- The system shall provide flexible archiving capability in terms of frame rate, duration, and location and shall utilize dynamic file allocation to ensure that the

full duration of the selected video stream will be recorded, regardless of lighting condition, motion, or scene detail.

- System shall support access to the archived video, to seek to any point in the archive, to set the pre and post time, and to loop that segment of the archive.
- The system shall cater for redundant multi-site video storage. Meaning that the video feeds coming from the sites must be stored on primary and backup storage.
- The system shall provide a Management Console that shows the status of CPU, Memory, Disk Usage, and traffic analysis.
- The System shall support H.264 Compression Protocol and 128 bit encryption. The system shall provide diagnostic tools that support Simple Network Management Protocol (SNMP).
- The system shall provide for integration with other software applications through an open and published Application Programming Interface (API). Such applications shall include, but not be limited to, access control, video analytics, and other alarms and sensor inputs.
- The system shall be capable of running on a single physical server or distributed across the network, scaling to handle thousands of cameras and users.
- The system shall provide for or have the capability of interoperating with the functional modules providing the capability for multiple web-based display consoles to configure, manage, display, and control video throughout the IP network; multiple options to store video and audio; virtual matrix switching; client PC viewing; and, remote encoding and storage.
- The system shall be capable of simultaneously supporting 3rd party IP based cameras from a variety of different vendors.

The system shall provide the following administrator functionalities:

- Secure login
- Server, encoder, and camera administration
- Scheduled and event-based video recording
- User and role management
- Fine-grained activity reports and system audit
- Ability to push pre-defined views to any number of digital monitors with Virtual Matrix
- Ability to schedule to operator shifts, event filters, temporary views.

The operator workstations running as part of the Video Management System shall provide the following operator functionalities:

- Secure login
- Flexible video displays
- PTZ controls including presets and advanced camera options (e.g. focus, white balance, iris)
- Digital zoom and instant replay
- Create instant recordings, “Record Now”
- Client-side video enhancements (adjusting brightness, color, transparency, etc.)
- Instantly swap between live and archive video of the same camera feed
- Archive review and clipping
- Event notifications
- Ability to search archived video based on motion within a predefined window within the video frame
- Synchronize playback of multiple archives

Supported file format types shall include:

- WMV - A standard file format for downloading and playing audio/video data or to stream data on a PC.
- AVI - A standard file format for storing audio/video data on a PC.MP2
- Clip (BWM) - A segment of video extracted from an existing stream-able archive.
- Digitally Signed Clip (BWX) - A segment of video extracted from an existing stream-able archive and signed with a digital signature to verify content has not been tampered with.

Operator Workstation:

- The minimum configuration of the Operator workstation PCs and the Video Wall PCs shall be:
 - workstation based on the new Intel® X38 Express performance chipset and the latest workstation-class dual core Intel processors:
 - Intel’s Core™ 2 Duo (2.83 GHz, 4 MB L2 Cache) / Core i-7 or better
 - DDR-2 800 MHz ECC
- Should include the following Components:
 - 160 GB SATA 3 GB/s NCQ 7200, 1st HDD
 - Intel Core 2 Duo E6850 3.0 4 MB/1333 CPU
 - 8 GB, DDR2-800 ECC Memory
 - 768 MB PCIe Graphics

- Microsoft Windows XP Pro 32-bit OS
- Graphic card: NVIDIA®, GeForce® FX 5700 Ultra, FX 5900 Ultra or FX 5950 Ultra, Matrox Parhelia™, ATI RADEON® 8500,9500,9800
- The Operator workstation PC and the Video Wall PC will be separate and the two applications will not be combined on the same PC.

The minimum configuration of the Management and Recording servers shall be:

- Rack mounted, high end server - Multi processor based on a latest Intel processor.
- Minimum 8 GB of RAM
- Network adapter 1000 Mbps Ethernet
- Standard sound card is optional and recommended.
- Minimum 750GB storage capacity for installation.
- Redundant Power Supply.

15.27.5 Storage Requirements

The video storage system shall have following features:

- Recording of all the camera streams must be stored for the period of 30days on DAS, NAS or SAN.
- The storage media must be SATA drives or Fiber Channel drivers or Flash Drives.
- Minimum storage requirement is 1TB raw (The supplier to confirm the storage requirement as per number of cameras, pixel resolutions, video compression and number of recording days)
- The storage servers must have redundant power supply and meet high availability standards
- The storage should be RAID 5 configured for disaster recovery.
- Each recording unit/server should allow for internal storage up to 32 TB per recording unit so as to allow expansion if later required

15.27.6 CCTV Color LCD Monitor

- The Video Color LCD Monitor shall be high performance with high resolution.
- Its image signal input / output port terminal allow bridge connection.
- The Video monitor shall have operating controls & shall be mounted below or on side-front of its screen.

- It should have 450v lines Resolution and variable control Knobs to control contrast, V hold H-Hold & brightness.
- Push buttons switch to control power On / Off and separate LED pilot light.
- The video monitor screen size shall be 59" (inches) flat & square tube shall produce clear distortion less viewing all the way out to the edge and corners of the screen.
- It shall consist of S- video input / output connectors separated output. Input signal shall be 1.0V p-p and impedance 75 ohms.
- The power source shall be AC 198-264 auto and power consumption shall be not more than 36 W.
- It shall consist of Automatic Voltage selector (AVS) to level voltage fluctuation instantly and automatically.

15.27.7 INTEGRATION (OPTIONAL)

CCTV system shall be integrated with Fire alarm system, Emergency Voice Evacuation system, Access control system and Building Management system for sequential operations and status monitoring.

Contents

CHAPTER – 16	ROAD AND BRIDGES	4
16.1	GENERAL	10
16.1.1	Introduction	10
16.1.2	Glossary of Highway Engineering Terms	16
16.2	EARTHWORK FOR ROADS	38
16.2.1	Subgrade Preparation	38
16.2.2	Improved Subgrade	41
16.2.3	Soil Cement Stabilized Subgrade	43
16.2.4	Lime Stabilized Subgrade	46
16.2.5	Bitumen Stabilized Subgrade	49
16.2.6	Dressing and Compaction of Berms	51
16.2.7	Reinstatement of Shoulders from Brick Kiln	53
16.2.8	Overhaul of Excavation	54
16.2.9	Cable Ducts	55
16.3	SUB-BASE AND BASE	58
16.3.1	Granular Sub-Base (Sub-base Course Mechanically Stabilized Soil Aggregate)	58
16.3.2	Aggregate Base Course	61
16.3.3	Asphaltic Base Course Plant Mix	63
16.3.4	Soil Cement Stabilized Sub-Base or Base	72
16.3.5	Crack Relief Layer	77
16.3.6	Water Bound Macadam Base	79
16.3.7	Deep Patching	83
16.3.8	Reinstatement of Road Surface	84
16.3.9	Pavement Widening	85
16.3.10	Lime Stabilized Aggregate Base Course	86
16.3.11	Bitumen Stabilized Subbase or Base	89
16.3.12	Cold Recycling of Road Pavement Structure/ Soil Stabilization	93
16.3.13	Asphaltic Concrete Binder Course	95
16.3.14	Geotextiles	98
16.3.15	Soling Stone	102
16.3.16	Interlocking Concrete Paving Blocks	103
16.3.17	Brick Edging	106
16.3.18	Drainage Layer Under Shoulders	107
16.3.19	Sub Base Course-Brick Paved	109
16.4	SURFACE COURSES AND PAVEMENT	112
16.4.1	General	112
16.4.2	Asphaltic Courses	112
16.4.3	Bituminous Prime Coat	117
16.4.4	Bituminous Tack Coat	120
16.4.5	Bituminous Surface Treatment and Surface Dressing (Seal Coat / Pad Coat)	122
16.4.6	Semi Grout Surfacing	130
16.4.7	Penetration Macadam	133
16.4.8	Asphaltic Base Course Plant Mix	137
16.4.9	Asphaltic Concrete Binder Course	147
16.4.10	Asphaltic Concrete Wearing Course – Plant Mix	150
16.4.11	Asphaltic Concrete Wearing Course (Plant Mix) with Cellulose Fiber	154
16.4.12	Shoulder Treatment	160
16.4.13	BIT – MAC	162
16.4.14	Hot Recycling of Asphalt Concrete	166
16.4.15	Cold Milling	168

16.4.16	<i>Proof Rolling</i>	169
16.5	CEMENT CONCRETE AND CONCRETE PAVEMENTS	170
16.5.1	<i>Concrete</i>	170
16.5.2	<i>Concrete Pavements</i>	197
16.6	STRUCTURES	214
16.6.1	<i>General</i>	214
16.6.2	<i>Materials</i>	214
16.6.3	<i>Construction Requirements</i>	214
16.6.4	<i>Measurement and Payment</i>	215
16.6.5	<i>Form Work, False Work and Centering for Bridges</i>	216
16.6.6	<i>Steel Reinforcement</i>	221
16.6.7	<i>Prestressed Concrete Structures</i>	227
16.6.8	<i>Joints and Bearing Devices for Concrete Structures</i>	235
16.6.9	<i>Steel Structures</i>	241
16.6.10	<i>Piles</i>	259
16.6.11	<i>Brick Masonry</i>	259
16.6.12	<i>Random and Dressed Un coursed Stone Masonry</i>	263
16.6.13	<i>Dressed Coursed Stone Masonry</i>	265
16.7	DRAINAGE AND EROSION WORKS	271
16.7.1	<i>General</i>	271
16.7.2	<i>Reinforced Concrete Pipe Culverts</i>	271
16.7.3	<i>Bedding or Encasement of Concrete Pipe Culverts</i>	276
16.7.4	<i>Under Drain</i>	277
16.7.5	<i>Headwalls, Wingwalls, Parapets Approach Slabs, and Aprons</i>	279
16.7.6	<i>Manholes</i>	280
16.7.7	<i>Drop Inlets and Catch Basins</i>	283
16.7.8	<i>Gabions</i>	285
16.7.9	<i>Riprap and Reinforced Concrete Slope Protection</i>	287
16.7.10	<i>Stone Pitching</i>	291
16.7.11	<i>Ditch Lining and Wash Checks</i>	293
16.7.12	<i>Bridge Drainage System</i>	295
16.8	ANCILLARY WORKS	300
16.8.1	<i>General</i>	300
16.8.2	<i>Concrete curb, Gutters and Channels</i>	300
16.8.3	<i>Asphalt Concrete and Cement Concrete Sidewalk</i>	304
16.8.4	<i>Metal Beam Guard Rail</i>	307
16.8.5	<i>Cement Concrete Beam Guardrail</i>	309
16.8.6	<i>Bridge Railing</i>	310
16.8.7	<i>Traffic Road Signs and Safety Devices</i>	312
16.8.8	<i>Pavement Marking</i>	319
16.8.9	<i>Precast Concrete Posts and Markers</i>	328
16.8.10	<i>Reflectorized Pavement Studs</i>	330
16.8.11	<i>Fencing</i>	333
16.8.12	<i>Reflective Traffic Mirrors</i>	334
16.8.13	<i>Retaining Walls</i>	337
16.8.14	<i>Boundary Pillars</i>	343
16.8.15	<i>Kilometer Stones</i>	343
16.8.16	<i>Road Survey Accessories</i>	344
16.9	REPAIRING OF EXISTING PAVEMENT	345
16.9.1	<i>Asphalt Pavement Crack Routing and Sealing</i>	345
16.9.2	<i>Asphalt Pavement Crack Sealing</i>	347
16.9.3	<i>Crack Repair - Spray Patch</i>	349
16.9.4	<i>Crack Repair - Mill and Fill</i>	350

16.9.5 Surface Dressing on Old Surface with Hot Bitumen 352

CHAPTER – 16 ROAD AND BRIDGES**References:**

Sr.#	Standard Name	Description
Chapter – 16 Roads and Bridges		
AASHTO		
1.	AASHTO T-180 Method "D (Modified)	Standard Method of Test for Moisture–Density Relations of Soils.
2.	AASHTO M-145	Standard Specification for Classification of Soils and Soil–Aggregate Mixtures for Highway Construction Purposes.
3.	AASHTO T 96	Standard Method of Test for Resistance to Degradation of Small-Size Coarse Aggregate by Abrasion and Impact in the Los Angeles Machine.
4.	AASHTO T 104	Standard Method of Test for Soundness of Aggregate by Use of Sodium Sulfate or Magnesium Sulfate
5.	AASHTO T 176	Standard Method of Test for Plastic Fines in Graded Aggregates and Soils by Use of the Sand Equivalent Test
6.	AASHTO T 89	Standard Method of Test for Determining the Liquid Limit of Soils.
7.	AASHTO T-90	Standard Method of Test for Determining the Plastic Limit and Plasticity Index of Soils.
8.	AASHTO T-182	Standard Method of Test for Coating and Stripping of Bitumen-Aggregate Mixtures.
9.	AASHTO M - 20	Standard Specification for Penetration-Graded Asphalt Cement
10.	AASHTO T-195	Standard Method of Test for Determining Degree of Particle Coating of Asphalt Mixtures.
11.	AASHTO T 147	The Field Determination of Density of Soil In-Place.
12.	AASHTO T 180	Standard Method of Test for Moisture–Density Relations of Soils Using a 4.54-kg (10-lb) Rammer and a 457-mm (18-in.) Drop
13.	AASHTO T-27	Standard Method of Test for Sieve Analysis of Fine and Coarse Aggregates.
14.	AASHTO T-32	Standard Method of Test for Sampling and Testing Brick.
15.	AASHTO - M20	Standard Specification for Penetration-Graded Asphalt Cement.
16.	AASHTO M-82	Standard Specification for Cutback Asphalt (Medium-Curing Type)
17.	AASHTO M-81	Standard Specification for Cutback Asphalt (Rapid-Curing Type)
18.	AASHTO M-140	Standard Specification for Emulsified Asphalt.
19.	AASHTO T-96	Resistance to Degradation of Small-Size Coarse Aggregate by Abrasion and Impact in the Los Angeles Machine.
20.	AASHTO M 156	Standard Specification for Requirements for Mixing Plants for Hot-Mixed, Hot-Laid Bituminous Paving Mixtures.
21.	AASHTO M 31 (ASTM A 615)	Standard Specification for Deformed and Plain Carbon and Low-Alloy Steel Bars for Concrete Reinforcement
22.	AASHTO M 225 (ASTM A 496)	Specification for Steel Wire, Deformed, for Concrete Reinforcement.

23.	AASHTO M 55 (ASTM A 185)	Standard Method of Test for Steel Welded Wire Reinforcement, Plain, for Concrete.
24.	AASHTO M 54 (ASTM A 184)	Standard Specification for Welded Deformed Steel Bar Mats for Concrete Reinforcement.
25.	AASHTO M 32 (ASTM A 82)	Standard Specification for Cold-Drawn Steel Wire for Concrete Reinforcement.
26.	AASHTO M 221 (ASTM A 497)	Steel Welded Wire Fabric, Deformed for Concrete Reinforcement.
27.	AASHTO M31	Standard Specification for Deformed and Plain Carbon and Low-Alloy Steel Bars for Concrete Reinforcement.
28.	AASHTO 225 M	Standard specification for Steel Wire, Deformed for Concrete Reinforcement.
29.	AASHTO M 55	Steel Welded Wire Fabric, Plain, for Concrete Reinforcement.
30.	AASHTO M 54	Fabricated Bar or Rod Mats for Concrete Reinforcement.
31.	AASHTO M 32	Standard Specification for Cold-Drawn Steel Wire for Concrete Reinforcement.
32.	AASHTO M 221	Steel Welded Wire Fabric, Deformed for Concrete Reinforcement.
33.	AASHTO M 153 (ASTM D 1752)	Standard specification for Preformed Sponge Rubber and Cork Expansion Joint Fillers for Concrete Paving and Structural Construction.
34.	AASHTO M 213 (ASTM D 1751)	Standard specification for Preformed Expansion Joint Fillers for Concrete Paving and Structural Construction (Non-extruding and Resilient Bituminous Types)
35.	AASHTO M 220	Standard specification for Preformed Polychloroprene Elastomeric Joint Seals for Concrete Pavements.
36.	AASHTO M 72	Specification for Red Lead Ready-Mixed Paint.
37.	AASHTO M 67	Standard Specification for Foliage Green Bridge Paint.
38.	AASHTO M 68	Standard Specification for Black Paint for Bridges or Timber Structures.
39.	AASHTO M 69	Standard Specification for Aluminum Paint. (Inactive)
40.	AASHTO M 70	Standard Specification for White and Tinted Ready-Mix Oil Base Paint.
41.	AASHTO M 71	Standard Specification for Red Lead (Dry and Paste-in- Oil) and Paint Made Therefrom.
42.	AASHTO M 72	Standard Specification for Red Lead Ready-Mixed Paint.
43.	AASHTO M 270M/M 270	Standard Specification for Structural Steel for Bridges.
44.	AASHTO/AWS D1.5M/D1.5	Bridge Welding Code.
45.	AASHTO T 106	Standard Method of Test for Compressive Strength of Hydraulic Cement Mortar (Using 50-mm or 2-in. Cube Specimens).
46.	AASHTO T 160	Standard Method of Test for Length Change of Hardened Hydraulic Cement Mortar and Concrete.
47.	AASHTO M114 (ASTM C62)	Standard Specification for Building Brick (Solid Masonry Units Made From Clay or Shale).
48.	AASHTO M 45	Standard Specification for Aggregate for Masonry Mortar.
49.	AASHTO M 85	Standard Specification for Portland Cement.
50.	AASHTO M-170	Standard Specification for Reinforced Concrete Culvert, Storm Drain, and Sewer Pipe.

51.	AASHTO M-198	Standard Specification for Joints for Concrete Pipe, Manholes, and Precast Box Sections Using Preformed Flexible Joint Sealants.
52.	AASHTO M-170	Standard Specification for Reinforced Concrete Culvert, Storm Drain, and Sewer Pipe.
53.	AASHTO T-191	Standard Specification for Testing Culvert Pipe.
54.	AASHTO T 180	Standard Specification for Moisture-Density Relations of Soils Using a 4.54-kg (10-lb) Rammer and a 457-mm (18-in.) Drop
55.	AASHTO M 175 or ASTM C-444	Standard Specification for Perforated Concrete Pipe.
56.	AASHTO M 176	Standard Specification for Porous Concrete Pipe.
57.	AASHTO M170	Standard Specification for Reinforced Concrete Culvert, Storm Drain, and Sewer Pipe.
58.	AASHTO M 105	Standard Specification for Gray Iron Castings.
59.	AASHTO M 103	Standard Specification for Mild- to Medium-Strength Carbon-Steel Castings for General Applications.
60.	AASHTO M 193 or ASTM A 283	Standard Specification for Cast Aluminum Alloy Railing Posts.
61.	AASHTO M 111	Standard Specification for Zinc (Hot-Dip Galvanized) Coatings On Iron And Steel Products.
62.	AASHTO M 106	Standard Specification for Malleable Iron Castings.
63.	(AASHTO M 120)/ (ASTM A90)	Standard Test Method for Weight [Mass] of Coating on Iron and Steel Articles with Zinc or Zinc-Alloy Coatings.
64.	AASHTO T-66	Uniformity of Coating by the Preece Test (Copper Sulfate Dip) on Zinc-Coated (Galvanized) Iron or Steel Articles
65.	AASHTO M63	Standard Specification for Crushed Stone, Crushed Slag and Crushed Gravel for Open- Graded Bituminous Road-Mix Surface Course.
66.	AASHTO M 153	Standard Specification for Preformed Sponge Rubber and Cork Expansion Joint Fillers for Concrete Paving and Structural Construction.
67.	AASHTO M-200	Standard Specification for Epoxy Protective Coatings.
68.	AASHTO M 180	Standard Specification for Corrugated Sheet Steel Beams for Highway Guardrail.
69.	AASHTO M 183	Standard Specification for Structural Steel. (Inactive)
70.	AASHTO M31	Standard Specification for Deformed and Plain Carbon and Low-Alloy Steel Bars for Concrete Reinforcement.
71.	AASHTO M53	Standard Specification for Axle-Steel Deformed and Plain Bars for Concrete Reinforcement.(Inactive)
72.	AASHTO M 42	Standard Specification for Rail-Steel Deformed and Plain Bars for Concrete Reinforcement (Inactive)
73.	AASHTO M133	Standard Specification for Preservatives and Pressure Treatment Processes for Timber.
74.	AASHTO M168	Standard Specification for Wood Products.
75.	AASHTO M137	Standard Specification for Minimum Requirements for the Deformations of Deformed Steel Bars for Concrete Reinforcement.
76.	AASHTO Designation M-247	Standard Specification for Glass Beads Used in Pavement Markings.
77.	(AASHTO M280) ASTM A 121	Standard Specification for Metallic-Coated (Carbon) Steel Barbed Wire.

78.	AASHTO M 181	Standard Specification for Chain-Link Fence.
79.	AASHTO M 183	Standard Specification for Structural Steel.
80.	AASHTO T 99 Method C or D	Standard Method of Test for Moisture–Density Relations of Soils Using a 2.5-kg (5.5-lb) Rammer and a 305-mm (12-in.) Drop
ASTM		
81.	ASTM 153	Standard Specification for Zinc Coating (Hot-Dip) on Iron and Steel Hardware.
82.	ASTM D 4061	Standard Test Method for Retro reflectance of Horizontal Coatings.
83.	ASTM E 303	Standard Test Method for Measuring Surface Frictional Properties Using the British Pendulum Tester.
84.	ASTM E 308	Standard Practice for Computing the Colors of Objects by Using the CIE System.
85.	ASTM E 1349	Standard Test Method for Reflectance Factor and Color by Spectrophotometry Using Bidirectional (45°:0° or 0°:45°) Geometry.
86.	ASTM A 153	Standard Specification for Zinc Coating (Hot-Dip) on Iron and Steel Hardware.
87.	ASTM A 501	Standard Specification for Hot-Formed Welded and Seamless Carbon Steel Structural Tubing.
88.	ASTM A 283 Grade D	Standard Specification for Low and Intermediate Tensile Strength Carbon Steel Plates.
89.	ASTM B 209	Standard Specification for Aluminum and Aluminum-Alloy Sheet and Plate.
90.	ASTM Designation A 153 (AASHTO M 232)	Standard Specification for Zinc Coating (Hot-Dip) on Iron and Steel Hardware.
91.	ASTM Designation A 325(AASHTO M614)	Standard Specification for Structural Bolts, Steel, Heat Treated, 120/105 ksi Minimum Tensile Strength. (Replaced by F3125/F3125M)
92.	ASTM A 153	Standard Specification for Zinc Coating (Hot-Dip) on Iron and Steel Hardware.
93.	ASTM A307	Standard Specification for Carbon Steel Bolts, Studs, and Threaded Rod 60 000 PSI Tensile Strength.
94.	ASTM E 8	Standard Test Methods for Tension Testing of Metallic Materials.
95.	ASTM A536 or A47/A47M	Standard Specification for Ductile Iron Castings.
96.	ASTM A377 (ANSI 21.51)4	Standard Index of Specifications for Ductile Iron Pressure Pipe.
97.	ASTM A47/A47M	Standard Specification for Ferritic Malleable Iron Castings.
98.	ASTM A575	Standard Specification for Steel Bars, Carbon, Merchant Quality, M-Grades.
99.	ASTM A307	Standard Specification for Carbon Steel Bolts, Studs, and Threaded Rod 60 000 PSI Tensile Strength.
100.	A572	Standard Specification for High-Strength Low-Alloy Columbium-Vanadium Structural Steel.
101.	A242	Standard Specification for High-Strength Low-Alloy Structural Steel.
102.	ASTM A108	Standard Specification for Steel Bar, Carbon and Alloy, Cold-Finished.

103.	ASTM A500	Standard Specification for Cold-Formed Welded and Seamless Carbon Steel Structural Tubing in Rounds and Shapes.
104.	ASTM A36	Standard Specification for Carbon Structural Steel.
105.	ASTM A48M	Standard Specification for Gray Iron Castings.
106.	ASTM A641/641M	Standard Specification for Zinc-Coated (Galvanized) Carbon Steel Wire.
107.	ASTM B 117	Standard Practice for Operating Salt Spray (Fog) Apparatus.
108.	ASTM D 2049	Test Method for Relative Density of Cohesionless Soils. (superseded by ASTM D4253)
109.	ASTM A 26	Specification for Steel Tires (Withdrawn) Replaced by A551/A551M.
110.	ASTM A 325	Standard Specification for Structural Bolts, Steel, Heat Treated, 120/105 ksi Minimum Tensile Strength (Withdrawn) Replaced by F3125/F3125M.
111.	ASTM A-36 221	Standard Specification for Carbon Structural Steel.
112.	D-4254 (ASTM)	Standard Test Methods for Minimum Index Density and Unit Weight of Soils and Calculation of Relative Density.
113.	ASTM D995-617	Standard Specification for Mixing Plants for Hot-Mixed, Hot-Laid Bituminous Paving Mixtures.
114.	ASTM A 36	Standard Specification for Carbon Structural Steel.
115.	ASTM A510	Standard Specification for General Requirements for Wire Rods and Coarse Round Wire, Carbon Steel.
116.	ASTM A 441	Standard Specification for High-Strength Low-Alloy Structural Manganese Vanadium Steel.
117.	ASTM A 572	Standard Specification for High-Strength Low-Alloy Columbium-Vanadium Structural Steel.
118.	ASTM A 514	Standard specification for High-Yield-Strength, Quenched and Tempered Alloy Steel.
119.	ASTM A 449	Standard Specification for Hex Cap Screws, Bolts and Studs, Steel, Heat Treated, 120/105/90 ksi Minimum Tensile Strength, General Use.
120.	ASTM A 325	Standard Specification for Structural Bolts, Steel, Heat Treated, 120/105 ksi Minimum Tensile Strength.
121.	ASTM A 588	Standard Specification for High-Strength Low-Alloy Structural Steel, up to 50 ksi [345 MPa] Minimum Yield Point, with Atmospheric Corrosion Resistance.
122.	ASTM A 307	Standard Specification for Carbon Steel Bolts, Studs, and Threaded Rod 60 000 PSI Tensile Strength.
123.	ASTM A 668	Standard Specification for Steel Forgings, Carbon and Alloy, for General Industrial Use.
124.	ASTM A 27	Standard Specification for Steel Castings, Carbon, for General Application.
125.	ASTM A 48	Standard Specification for Gray Iron Castings.
126.	ASTM A 47	Standard Specification for Ferritic Malleable Iron Castings.
127.	ASTM A 500	Standard Specification for Cold-Formed Welded and Seamless Carbon Steel Structural Tubing in Rounds and Shapes.
128.	ASTM A 501	Standard Specification for Hot-Formed Welded and Seamless Carbon Steel Structural Tubing.
129.	ASTM A 53	Standard Specification for Pipe, Steel, Black and Hot-Dipped, Zinc-Coated, Welded and Seamless.

130.	ASTM A 108	Standard Specification for Steel Bar, Carbon and Alloy, Cold-Finished.
131.	ASTM A 441	Specification for High-Strength Low-Alloy Structural Manganese Vanadium Steel (withdrawn)
132.	A 572	Standard Specification for High-Strength Low-Alloy Columbium-Vanadium Structural Steel.
133.	A 588	Standard Specification for High-Strength Low-Alloy Structural Steel, up to 50 ksi [345 MPa] Minimum Yield Point, with Atmospheric Corrosion Resistance.
BS EN		
134.	BS EN ISO 591-1:2000	Titanium dioxide pigments for paints. Specifications and methods of test.
135.	BS EN ISO 3262-13:1998	Extenders for paints. Specifications and methods of test. Natural quartz (ground).
BS		
136.	BS 381C SET:1996 (R2002)	Specification for colors for identification, coding and special purposes.

16.1 General

16.1.1 Introduction

1. Preamble

General Specifications have been produced for National Highway Authority, keeping in consideration that following types of activities are being carried out in this organization: -

- Construction of Motorways, new Highways, Bridges and allied works.
- Rehabilitation and Improvement of existing road network.
- Maintenance of existing roads and structures.

All the above three aspects of construction, rehabilitation and maintenance have been covered in these General Specifications. Subsequent chapters would give a list of such items of work with an indication of their probable use, in case of the above three categories of works.

2. Standards

These Specifications describe the requirements and procedures for execution of work items to achieve required workmanship and quality. The materials to be used shall conform to specifications and testing procedures as per American Association of State Highway and Transportation Officials (AASHTO), the American Society for Testing and Materials (ASTM) or British Standard (B.S.) as indicated in their latest editions. Samples of materials for laboratory tests and their subsequent approval shall be utilized according to these references.

3. Manpower

Contractor shall also provide skilled manpower in adequate number, who can perform execution with quality and workmanship control in accordance with the requirements of the work item.

4. Equipment

Number and kind of Equipment required for different items of work shall be planned by the contractor keeping in view the workmanship required by a particular item and the quantity of finished item required to be carried out in eight hours shift. The Engineer shall approve such planning or any changes shall be proposed for guidance of the Contractor. However, this procedure shall not relieve the Contractor of his contractual obligations pertaining to performance and maintenance of project.

5. Alternative Equipment

While few of these specifications may provide that equipment of a particular size and type is to be used to perform portions of the work, it is to be understood that the deployment and use of new or improved equipment is to be encouraged. The Contractor may request, in writing, permission from the Engineer to use equipment of a different size or type in place of the equipment specified or recommended in these chapters. The Engineer, before considering or granting such request, may require the Contractor to furnish, at his expense, evidence to satisfy the Engineer that the equipment proposed for use by the Contractor is capable of producing work equal to or better in quality than, that which can be produced by the equipment

specified. If such permission is granted by the Engineer. it shall be understood that such permission is granted for the purpose of testing the quality of work actually produced by such equipment and is subject to continuous attainment of results which, in the opinion of the Engineer, are equal to, or better than, that which can be obtained with the equipment specified. The Engineer shall have the right to withdraw such permission at any time when he determines that the alternative equipment is not producing work of equal quality in all respects, to that which can be produced by the equipment specified. Upon withdrawal of such permission by the Engineer, the Contractor will be required to use the equipment originally specified and shall, in accordance with the directions of the Engineer, remove and dispose off or otherwise remedy, at his expense, any defective or unsatisfactory work produced with the alternative equipment. Neither the Employer nor the Contractor shall have any claim against the other for either the withholding or the granting of permission to use alternative equipment. or for the withdrawal of such permission. Nothing in this clause shall relieve the Contractor of his responsibility for furnishing materials or producing finished work of the quality specified in these specifications.

6. Storage of Materials

Articles or materials to be incorporated in the work shall be stored in such a manner as to ensure the preservation of their quality and fitness for the work, and to facilitate inspection.

7. Defective Materials

All materials which the Engineer has determined as not conforming to the requirements of the drawings and specifications will be rejected whether in place or not. They shall be removed immediately from the site of the work, unless otherwise permitted by the Engineer. No rejected material, the defects of which have been subsequently corrected, shall be used in the work, unless approval in writing has been given by the Engineer. Upon failure of the Contractor to comply promptly with any order of the Engineer made under the provisions in this clause, the Engineer shall have authority to cause the removal of rejected material and to deduct the cost thereof from any payments due or to become due to the Contractor.

8. Quarry Materials

Quarry material is rock, sand gravel, earth, or other mineral material, other than local borrow or selected material, obtained on the project. Quarry material does not include materials such as cement, lime, marble powder etc. obtained from established commercial sources. Quarry Materials shall be furnished by the Contractor from any source he may select, except that when mandatory local sources of certain materials are designated in the Special Provisions, the Contractor shall furnish material from such designated mandatory sources. The furnishing of quarry materials from any source is subject to the provisions of "Examination of drawings, Specifications, and item of Work". Unless approved in writing by the Engineer, material sources shall not be excavated at locations where the resulting scars will present an unsightly appearance from any highway. No payment will be made for material obtained in violation of this provision. The Contractor shall, at his expense, make any arrangements necessary for hauling over local public and private roads from any source. Full compensation for furnishing all labour, materials, tools, equipment, and incidentals, and for doing all the work involved in conforming to the provisions in this clause, for furnishing and producing materials from any source shall be considered as included in the price paid for the contract item of work involving such material and no additional compensation will be allowed therefor.

9. Trade Names and Alternatives

For convenience in designation on the plans or in the specifications, certain articles or materials to be incorporated in the work may be designated under a trade name or the name of a manufacturer and the catalogue information. The use of an alternative article or material that is of equal quality and of the required characteristics for the purpose intended will be permitted, subject to the following requirements: -

The responsibility of proof as to quality and suitability of alternatives shall be upon the Contractor and he shall furnish all information necessary as required by the Engineer. The Engineer shall be the sole judge as to the quality and suitability of alternative articles or materials and his decision shall be final. Whenever the specifications permit the substitution of a similar or equivalent material or article, no tests or action relating to the approval of such substitute material will be made until the request for the substitution is made in writing by the Contractor accompanied by complete data as to the equality of the material or article proposed. Such request shall be made well in time to permit approval without delaying the work.

10. Frequency of Tests & Test designation

Frequency of tests for the items of construction has been given in subsequent chapters. Test designation and procedure will be used as given in the latest version of relative publication.

11. Testing

Unless otherwise specified, all tests shall be performed in accordance with the methods used by AASHTO/ASTM and shall be made by the contractor under the supervision of the Engineer or his designated representative. Whenever the specifications provide an option between two or more tests, the Engineer will determine the test to be used. Whenever a reference is made in the specifications to a specification manual, or a test designation either of the American Society For Testing and Materials, the American Association of State Highway and Transportation Officials, Federal Highway Specification, or any other recognized national organization, and the number or other identification representing the year of adoption or latest revision is omitted, it shall mean the specification, manual or test designation in effect on the day 30 days prior to the date for submission of bids. Whenever said specification manual or test designation provides for test reports (such as certified mill test reports) from the manufacturer, copies of such reports, identified as to the lot of material, shall be furnished to the Engineer. When material that cannot be identified with specific test reports is proposed for use, the Engineer may, at his discretion, select random samples from the lot for testing. Test specimens from the random samples, including those required for retest, shall be prepared in accordance with the referenced specification and furnished by the Contractor at his expense. The number of such samples and test specimens shall be entirely at the discretion of the Engineer. Unidentified metal products such as sheet plate, hardware, etc. shall be subject to the test requirements prescribed by the Engineer. When desired by the Engineer, the Contractor shall furnish, without charge, samples of all materials entering into the work and no material shall be used prior to approval by the Engineer. Samples of material from local sources shall be taken by or in the presence of the Engineer, otherwise the samples will not be considered for testing.

12. Construction stakes, Lines and Grades

The Engineer will furnish design survey data and jointly locate with contractor, all points of intersection and of tangents and basic benchmarks. The plans indicate the properties of horizontal and vertical curves, together with rates of super elevation where required. The contractor shall set construction stakes establishing lines, slopes, and continuous profile-grade in road work, and center line and bench marks for bridge work, culvert work, protective and accessory structures and appurtenances and will furnish the Engineer with the original copy of the field notes together with all necessary information relating to lines, slopes and grades. These stakes and marks shall constitute the field control by and in accordance with which the contractor shall establish other necessary controls and perform the work. If, in the opinion of the Engineer, modification of the line or grade is advisable, before or after stakeout, the Engineer will issue detailed instructions to the Contractor for such modification and the Contractor will revise the stakeout for further approval. No change in bid unit price will be made for such modifications. The profiles and cross sections on the plans indicate the elevation of the top of road surface or as otherwise noted on the plans. The contractor shall be responsible for the preservation of all stakes and marks, and if any of the construction stakes or marks has been destroyed or disturbed, the Contractor will replace them at his own expense. The Contractor shall be responsible for the accuracy of all lines, slopes, grades, and other survey work.

13. As-Built Drawings/Shop Drawings

During construction, the Contractor shall keep an accurate record of all deviations of work as actually installed from that shown or indicated on the Contract Drawings or revised during construction. Upon completion of the Works, the Contractor shall deliver all "As Built" drawings to the Engineer. All shop drawings/fabrication drawings shall be prepared by the Contractor and submitted to the Engineer before the start of the work. The Engineer shall check and approve or return the same to the Contractor for correction/modification. All works are to be executed in accordance with shop drawings, approved before the commencement of the works. Shop drawings should truly reflect the provisions of typical drawings. Any deviation from the provision of contract drawings, shall not be allowed unless written approval is issued by the Engineer.

14. Utility Lines

The Contractor shall conduct his operations, make necessary arrangements, take suitable precautions and perform all required works incidental to the protection of and avoidance of interference with power transmission, telegraph, telephone and natural gas lines, oil lines water and sewerage mains and other utilities within the areas of his operations in connection with his contract and the Contractor shall save harmless and indemnify the Employer in respect of all claims, demands, proceedings, costs, charges and expenses whatsoever arising out of or in relation to any such interference.

15. Safety Precautions

The Contractor shall adequately provide for the safety, health and welfare of persons and for the prevention of damage to works, materials and equipment for the purpose of or in connection with the Contract.

16. Inspections

The Engineer shall, at all times, have safe access to the work during its construction, and shall be furnished with every reasonable facility for ascertaining that the materials and the workmanship are in accordance with the requirements and intentions of these Specifications, the Special Provisions, and the plans/drawings. All works done and all materials furnished shall be subject to inspection by Engineer. The inspection of the work or materials shall not relieve the Contractor of any of his obligations to fulfill his contract as prescribed. Work and materials not meeting such requirements shall be made good and unsuitable work or materials may be rejected, notwithstanding that such work or materials have been previously inspected by the Engineer or that payment therefor has been included in a progress estimate.

17. Removal of Rejected and Unauthorized work

All works, which have been rejected, shall be remedied, or removed and replaced by the Contractor in an acceptable manner and no compensation will be allowed to him for such removal, replacement, or remedial work. Any work done beyond the lines and grades shown on the plans or established by the Engineer, or any extra work done without written authority will be considered as unauthorized work and will not be paid for. Upon order of the Engineer, unauthorized work shall be remedied, removed, or replaced at the Contractor's expenses. Upon failure of the Contractor to comply promptly with any order of the Engineer made under this Item, the Employer may cause rejected or unauthorized work to be remedied, removed, or replaced and to deduct the costs from any payment due or to become due to the Contractor.

18. Alternative Methods of Construction

Whenever the plans or specifications provide that more than one specified method of construction or more than one specified type of construction equipment may be used to perform portions of the work and leave the selection of the method of construction or the type of equipment to be used up to the Contractor, it is understood that the Employer does not guarantee that every such method of construction or type of equipment can be used successfully throughout all or any part of any project. It shall be the Contractor's responsibility to select and use the alternative or alternatives, which will satisfactorily perform the work under the conditions encountered. In the event some of the alternatives are not feasible or it is necessary to use more than one of the alternatives on any project, full compensation for any additional cost involved shall be considered as included in the contract price paid for the item of work involved and no additional compensation will be allowed thereof.

19. Conformity with Contract documents

Work and materials shall conform to the lines, grades, cross sections, dimensions and material requirements, including tolerances, shown on the plans or indicated in the specifications. Although measurement, sampling and testing may be considered evidence as to such conformity, the Engineer shall be the sole judge as to whether the work or materials deviate from the plans and specifications, and his decision relating to any allowable deviations therefrom shall be final.

20. Trial Section

Contractor shall submit complete methodology of trial section for approval of the Engineer. Trial sections shall be prepared for each type of road pavement layer. In spite of the approval of Engineer for trial section, contractor shall be responsible for the quality of work. Contractor will provide minimum of following information's in the methodology.

- Equipment to be used.
- Layer thickness adopted
- Per day production.
- Results of tests.

21. Scope

The Standard Specifications is a part of contract documents which shall be read in conjunction with the following contract documents which are mutually explanatory to one another and mentioned hereunder, with the order of precedence as given in the Condition of Contract.

- Contract Agreement.
- Instruction to bidders.
- Addenda.
- Letter of acceptance.
- Supplementary conditions.
- Special Provisions.
- Conditions of Contract Part – II
- Conditions of Contract Part - I.
- Drawings.
- General Specifications.
- The bid and Appendices "A to L"

16.1.2 Glossary of Highway Engineering Terms

Accepted:	Completion of the work Item to the Engineer's satisfaction.
Addendum:	A written amendment or revision to the Contract Documents or plans issued to bidders prior to the Final date and time for submission of Tenders in the "Instruction to Tenderers"
Abrasion:	The removal of material from the surface of a solid by grinding or rubbing action.
Aggregate:	For concrete works the work aggregate is collected into a mass, and is used for any hard material (stone or brick) for mixing into small fragments with cement or mortar and form concrete. For (bituminous) pavement it is meant to include angular pieces of hard crushed stone. The word coarse aggregate is usually employed for material coarser than 6 mm and fine aggregate down up to sand.
Alignment:	The position and direction given to the centerline of a road in plan or profile.
Alignment (Horizontal):	The position and direction of centerline of a road in plan.
Alignment (Vertical):	The position and direction of centerline of a road in profile.
Alignment (Re-alignment):	The alteration to the alignment of an existing road.
Amenities:	Recreational facilities and similar items provided to improve living conditions at site-characteristics conducive to pleasantness
Apron:	A layer or layers of concrete brick or stone masonry or stone, placed at the entrance or outlet of culvert or waterway or along the toe of an embankment etc, to prevent scour.
Asphalt:	Is A mixture of bitumen and mineral matter which may occur in natural deposits, or be produced by artificial means. In the first class we have the so called Natural or Rock Asphalts and in the second the Residual or petroleum Asphalts. (Bitumen is the binding material in asphalt)
Asphalt Base Course:	The lowermost layer of specified thickness of an asphalt concrete pavement which may include an asphalt leveling course.

Asphaltic Cement:	Is Asphaltic bitumen or the product resulting from a mixture of asphalt and flux oils or asphaltic bitumen and flux oils producing a binder having cementing qualities suitable for the manufacture of asphalt pavements. It is refined asphalt.
Asphaltic Concrete:	Is A pre-mix or bitumen (with or without filler), sand, and not less than 30 percent by weight of mineral aggregate of a size larger than sand.
Asphalt Concrete Pavement:	All courses of asphalt aggregate mixtures placed above the layer of base course, subbase or improved subgrade. When placed directly on the subgrade, it is called full- depth asphalt pavement.
Asphaltic Macadam:	Is A mixture of bitumen (with or without filler) and a mineral aggregate of a size larger than sand. It can be made by the grouting or pre-mixed methods.
Auxiliary Lane:	That portion of the roadway adjoining the traveled way for speed change or other purposes supplementary to through traffic movements.
Axle Load:	The total load transmitted by all wheels whose centers may be included between two parallel transverse vertical planes 1.02 meter (40 inches) apart extending across the full width of the vehicle.
Attrition:	Is Mutual rubbing or grinding within the mass of mineral fragments under the action of traffic thereby producing an alteration in their shapes and sizes.
Back Fill:	Material used to replace or the act of replacing material removed during construction, also may denote material placed or the act of placing material at the back of abutments, retaining walls or similar structures.
Barrage:	A low dam or weir across a river equipped with a series of gates to regulate the water surface level above the weir.
Ballast:	(1) Small stones or gravel with grit, sand and clayey materials, of which the major proportion of the particles are retained on a standard sieve having 4 square meshes to the linear 25 mm and which when consolidated yields a coherent layer. (2) Stone or gravel of irregular unscreened sizes which may contain smaller material and also sand.
Batching Plant:	The mechanical equipment for measuring either by weight or by volume, the quantities of different ingredients required to make up each complete charge of mixer.
Bulldozer:	It is a tractor in the front of which is mounted a curved strong adjustable steel blade which is employed for

spreading and leveling by pushing loose excavated material. A tree dozer for felling trees and a stumper dozer is used for uprooting stumps.

Batten:	Beam, Structural member.
Beldar:	Unskilled labour employed on maintenance gangs for canals or roads.
Bid/Tender Price:	It is priced offer by the contractor to accomplish specific items of work or the entire project, in accordance with terms and conditions of the contract documents.
Bid Schedule:	It is a priced bill of quantities containing rates offered by the contractor for completion of various items according to drawings and specifications of the projects.
Bill of Quantities:	A list showing work quantities and specifying unit price and/or lump sum for specific items of work.
Bajri:	Is a term largely used to denote stone screenings ranging from fine stuff to about 25 mm gauge. This generally refers to a stone of soft variety for dressing of paths and sidewalks and as binding for the consolidation of water-bound macadam roads.
Boulder:	A rock fragment, usually rounded by weathering or abrasion with an average dimension of 10 centimeters or more.
Bund:	A continuous embankment, dike or levee (generally associated with training or containing the flow of rivers).
Bank:	(1) An earth slope formed or trimmed to shape. (2) A ridge of earth, stones, etc. naturally existing or specially constructed to guide the flow or prevent overflow in floods.
Base Coat:	Is An intermediate course between the base course and the wearing coat.
Base Course:	Is that part of the construction resting upon the sub-grade, and through which the load is transmitted to the sub-grade or the supporting soil. A base source is the layer immediately under the wearing surface.
Benching, stepping:	Is the formation of a series of small level platforms or steps upon an incline or slope.
Binder:	Is a term applied to tar or bitumen used for binding road metal.

Binder Course:	A mix of graded aggregate and bituminous material mixed in a plant which constitutes the lower layer of the surface course.
Bitumen Macadam:	It Consists of bitumen only.
Bituminous Macadam:	Means bitumen or tar macadam.
Bituminous Cement:	Is A general term for bituminous materials which bind together adjacent solid substances of a suitable nature.
Bitumen:	Is by-product of the distillation or evaporation of crude petroleum either by natural process or in a refinery and Is the basic constituent of asphalt. It is characteristically solid or semi-solid, black or brown in colour, is sticky and melts or softens on the application of heat. Bitumen used for roads is usually a highly refined product, containing from 90 to 99 percent of bitumen soluble in carbon Disulphide. (This is Asphaltic Bitumen and is referred to as Bitumen). Bitumen marketed in various grades suitable for various purposes and the different grades vary in "penetration". Natural bitumen is found in a lake in the island of Trinidad.
Bitumen (Cut Back):	Bitumen whose viscosity has been reduced by the addition of some suitable volatile diluents.
Bitumen (Emulsion):	An emulsion in which bitumen is suspended in a state of minute sub-divisions in water or in an aqueous solution with the aid of suitable emulsifying agents.
Bituminous Concrete:	A designed combination of dense graded mineral aggregate, filler and straight run bitumen mixed in a central plant, laid and compacted while hot.
Black-top Surface:	Is a general term applied to wearing coats or surfaces of roads in which tar or bitumen is used in a binder.
Bleeding:	Is the exudation of bituminous material on a road surface after construction.
Blinding, Gritting or Dressing:	Is the spreading of stone chips, sand or other fine material on a road surface after application of bituminous material, or to fill the voids or interstices in a water-bound macadam surface. Blind age - the fine material so used.
Blind Alley:	It is a way or road open at one end only.
Blotter:	It is A covering of a suitable material to absorb excess binder or to overcome bleeding.
Blown Bitumen:	It is also known as oxidized bitumen. Is produced by blowing air through molten, steam refined asphaltic

bitumen. This process produces bitumen with comparatively high melting point and lower ductility. Blown bitumen has better weathering properties than steam refined type.

Blinding: The application of a loose layer of specified fine material to reduce bleeding.

Blinding Layer: A layer of concrete or other material (generally thin) covering the surface of excavated ground or fill, forming a stable surface on which work may be constructed.

Borrow Material: Suitable material used primarily for road embankment.

Borrow area: A place, outside the right of way, unless otherwise specified, from which fill material will be obtained for construction of embankment etc.

Box culvert: A culvert constructed of rectangular cross-section.

Bridge: A structure designated to secure passage over an obstacle or waterway of more than 6 meters (20 linear feet).

Breast wall: A retaining wall on the hill side.

By-pass Road: It is a road to enable passage through traffic to avoid congested areas or other obstructions to movement.

Calendar day: Every day shown on the calendar.

C.B.R. (California Bearing Ratio): An empirical measure of the bearing capacity of a sub-grade, sub-base, base or pavement expressed as a percentage of the bearing capacity of a standard sample of crushed stone.

Camber Transverse slope: It is the convexity given to the curved cross section of a carriageway, between the crown and the edge of the carriage way; it is the difference in level between the crown and the edge of the carriageway. Sometimes called cross fall.

Carpet: It is a wearing surfacing obtained by laying bitumen or tar concrete in two or more coats in a thick mess of more than 25 mm.

Carriageway: It is that portion of the roadway designed and constructed for vehicular traffic.

Catchment Area: The watershed or area which contributes runoff to a drain or other drainage basin.

Catch Drain: Is a drain provided in the slope of a cutting to intercept the water flowing down the cut slope.

Causeway:	A paved waterway slightly raised above normal bed of the water channel.
Chipping:	The term is generally intended to include uncrushed gravel as well as crushed rock, of a gauge finer than 20 mm (25 mm to 3 mm according to B.S.S.)
Chips:	These are small angular fragments of stone containing no dust.
Coal Tar:	Is a bye-product in the manufacture of gas iron coal. It is viscous or liquid, resulting initially from the destructive distillation of coal which has been so refined as to be suitable for road work. Coal tar has some volatile oils which evaporate by exposure. heaving the brittle and friable. That is why overheating of tar is prohibited.
Corrugations:	These are ripples, waves or undulations which are liable to appear in all types of road surfaces.
Crazing:	It is the breaking up of a surface layer through cracking into some irregular shaped areas.
Creep:	The slow plastic movement of the material in a surface lower in the line and direction of traffic flow or gradient.
Crete ways:	A carriageway in which a cement concrete wearing surface is provided for the wheel tracks only.
Cross fall:	It is the fall given to the surface of any part of a roadway, at right angles to road length.
Crown:	It is the highest point (in cross-section) of a curved road surface, commonly at or near the centre. The level of crown is called road surface level.
Crude oil:	It is a term used for unrefined petroleum.
Contract and Contract Documents:	The written agreement between the Department and the contractor setting forth the obligations of the parties there under, including, but not limited to, the performance of the work, the furnishing of labour and materials, and the basis of payment. The Contract Documents include the invitation for tenders, the tender, notice of award, form of contract, contract bond, general conditions and special conditions, general specifications, supplemental specifications, special specifications plan, addenda, directives, change orders and supplemental agreements that are required to complete the Work, all of which constitute one instrument.
Contract Item (Pay Item):	A specifically described unit of work for which a unit price is provided in the tender.

Contract time:	The number of working days or calendar days allowed for completion of the contract, including authorized time extensions. In case a calendar date of completion is shown in the tender, in lieu of the number of working in calendar days the work contemplated shall be completed by that date.
Contractor:	The person, firm or corporation with whom the contract has been made by the employer, or to whom the contract has been assigned.
Compaction:	a) General: The process of inducing a closer packing of particles by mechanical means. b) Soil: The process whereby soil particles are constrained by rolling or other mechanical means to pack more closely together reducing air voids, and increasing the dry density of the soil.
Culvert:	A structure designed to secure passage over an obstacle or waterway of not more than 6 meters (20 linear feet).
Cut:	It is a term used when material is excavated to make a cutting.
Cut-back:	This term applies to a solution of bitumen in a volatile or partly volatile solvent such as kerosene or creosote. The addition of the solvent lowers the viscosity of the bitumen, (make it more freely) thus it can coat cold chippings more easily. When a cut-back is applied on water-bound surface, (the kerosene evaporates in few hours) it soaks in and hardens to bitumen. It is also called "fluxed" bitumen. Cut-backs contain about 80% bitumen and 20% solvent. Unlike emulsions, cut-backs have to be used on dry surface and with dry aggregate. Cut-back can be either applied cold or brought to working consistency by moderately heating to about 137°C before use to ensure sufficient fluidity and adhesion to stone, as opposed to heating to about 175°C. for bitumen.
Cutting:	It is that portion of the site of a road where the formation has been excavated below the ground level.
Caterpillar track:	It is an endless tread, generally of metal links, running over two or more wheels for the purpose of distributing the wheel loads over a greater area so as to permit of a vehicle so fitted passing over soft or uneven ground.
Department:	The Highway Department, Government of the Punjab unless otherwise specified.

Detour:	It is the term used for alternate circuitous route for traffic going around a closed portion of a road a temporary route.
Drain:	A trench cut in the ground for the purpose of receiving and conducting drainage water.
Dragging:	It is the term used for operation of smoothing out and reshaping irregularities in surface earthwork by means of a drag. (See further, under "plant and machinery Terms").
Drive-way:	It is a term used for a way to secure access from a road to private property.
Dry Density:	The weight of material after drying it to constant weight at 105°C (221°F) contained in a unit volume.
Dry Density (Maximum):	The dry density of soil obtained by a specified amount of compaction at the optimum moisture content.
Dual Carriageway:	A road in which there are two physically separated carriage ways reserved for up and down traffic separately.
Drag:	It is a machine fitted with two or more oblique blades, generally of steel, for scraping off and reshaping irregularities in the surface of earth or similar low type roads.
Dumper:	It is a vehicle for transporting excavating material, so designed as to be capable of discharging its load by forward tipping.
Edging:	It is a term used for bricks (or blocks of concrete or stone) embedded along the edges of a pavement to protect the pavement from damage caused by traffic.
Embankment:	It is a term used for an earthwork raised above the natural ground by the deposition of material to support construction at a higher level.
Emulsion:	It is a name used for a freely flowing liquid at ordinary temperature in which a substantial amount of bitumen or tar is suspended in a solution of water in a finely divided and stable state. Emulsions contain about 50 to 65 % of bitumen. Can be used in all climates and are very useful for patch repairs on bituminous surfaces. They are used cold and can work with wet chippings. When emulsion is spread on the road its "breaks" and changes from brown to black colour and the water soaks in or evaporates allowing the bitumen particles to reunite and lie on the surface. Emulsions are more easily applied than hot binders. This performance, however, is affected to a much greater degree by adverse weather. Because of relatively thin film of binder that remains on the road, smaller chippings (not more than 6 mm) must be used with emulsions than with hot binders. Before the

application of emulsion, the road surface should be thoroughly cleaned and slightly damped with water, and chippings spread and rolled before the emulsion has "broken".

- Engineer:** The duly authorized representative of the Employer/Government as Incharge of the work at site/acting directly or through his designated representative who is responsible for supervision of the work. (Where the term "The Engineer" is used in this document, it should be taken to mean Engineer).
- Equipment:** All machinery and equipment, together with the necessary supplies for up keep and maintenance, and also all tools and apparatus necessary for the proper construction and acceptable completion of work.
- Expansion Joint:** A space between two rigid parts of the same structure, formed to allow small relative movements to occur without the development of serious stresses, with or without provision of means to preserve functional continuity
- Extra work:** An item of work not provided for in the contract as awarded but found essential to the satisfactory completion of the work within its intended scope.
- Fair-weather Road:** It is name used for a road that can be used by traffic during dry weather only and not during monsoons.
- Fascines:** It is a term used for bundles of grass tied and laid across a sandy track for passing temporary traffic.
- Fat:** This term is used where there is excess of bituminous material.
- Fender Curb or wheel Guard:** Curb are so placed as to prevent the approach of, or to secure the constraint of wheeled traffic.
- Filler:** It is a term used for any fine mineral powder added to bituminous mixture in the course of manufacture, and which has been ground to such a degree of fineness that not less than 85% by weight passes a 75-micron sieve. The common fillers are - limestone dust, cement, granite dust, slate dust, slag dust, coal dust, china clay and fuller's earth. Lime seems to possess excellent qualities as a filler and is used most Fine sand passed through the 75-micron sieve should also be taken into account along with the quantity of filler as it also helps to some extent. The functions of a filler are: -
- a) to increase the viscosity of the binder and hence increase density and stability of the mixture,
 - (b) to enable a thicker film of binder to be held by the mixture,

(c) to improve the resistance of the binder to weathering, (d) to increase the effective volume of the binder, and (e) to reduce the apparent temperature susceptibility of the mixture.

(for dense surfacing-filler/binder mixtures have lower temperature' susceptibilities than straight binders of the same viscosity). It tends to reduce-Idle brittleness of a mix. in cold weather and the quantity of the filler can be considerably increased. After compaction the surface should show a close texture.

Flagstone:	It is a term used for a flat and relatively thin slab of natural or artificial stone for pavements subjected only to foot traffic.
Flash point:	Is the lowest temperature at which the vapor of a substance momentarily takes fire but does not continue to burn. Under specified conditions of test.
Fluxing:	Is softening hard bitumen or asphalt which is too hard for use, to the desired consistency by incorporation of certain oils. (The product is called Flux oil).
Fluxing Agent:	It is a substantially non-volatile material (Flux oil) used for reducing the consistency of a bitumen (softening bitumen).
Fly-over:	It is a junction so designed that traffic streams are divided to enable them to pass over or under each other.
Formation Width:	It is s the finished top width of earthwork in fill or cut for receiving the road structure. It is the "roadway" as already defined.
Formation	It is the surface of the ground in its final shape and level after completion of earthwork.
Foundation:	It is a term denoting that portion of a road structure lying on the formation level.
Fretting:	It is the loosening of a wearing surface under the action of traffic or weather, associated with the failure of the binding agent to keep the surface consolidated.
Final Hand Over:	The final acceptance of the work by the Department, as authorized by the General conditions of the contract.
Flexible Pavement:	A form of road construction, which, for the purpose of design, is assumed to have no flexural rigidity.
Forms of Formwork:	Shuttering including supports and falsework.
Force Majeure:	An unexpected and disruptive event, which may operate to excuse a party from a contract or part thereof.

Free Haul:	The maximum distance up to which excavated material is transported without extra charge.
Frustration of Contract:	Rendered impossible of performance by external cause beyond the contemplation of the parties.
Grading, trimming:	It is the operation of excavation and shaping the surface of earthworks. The final shaping of earth works.
Gravels:	These are rounded or water worn stones of irregular shape and size occurring in natural deposits with or without finer material. Gravel is usually harder and more rounded than bajri and may contain certain amount of earth or clay mixed with it.
Grit:	It is a fine small sized sharp-edged stone aggregate or coarse sand used for blinding roads surfaces which have received a bituminous dressing. It gives a suggestion of roughness in the stone and of roughness to the work.
Gritting:	This term is used for the operation of spreading small broken stones, chippings, or gravel.
Grouted macadam:	The term is used for a consolidated wearing surface formed by the application of a binder (Bitumen or Tar) in liquid state into the interstices of the mineral aggregate after the latter has been spread on the foundation. Consolidation may take place before or after the application of the binder. A macadam crust in which the stone aggregate is bound together by binder applied to penetrate to the desired depth.
Grouting:	The action by which a binder in liquid form cement, tar, bitumen, etc., is made to penetrate into joints, fissures or cracks in concrete work or between blocks, (or road aggregate) under the action of gravity or by applied pressure.
Grubbing:	It is a term used for uprooting and removing the stumps and roots of small trees plants, hedges, etc. from the site of the works.
Gutter:	It is an open drain constructed along the sides of a carriageway (in town areas) to carry away the water drained from the surface.
Gallon:	Unless otherwise specified, the word "gallon" used in the specifications designates the imperial gallon (4.546 litres) and not U.S. gallon (3.785 litres).
Gradient:	The rate of rise or fall with respect to the horizontal plane along the centerline of a road or bridge.
Gravel Road:	A road constructed with layers of gravel with or without the addition of sand or clay.

Guarantor:	A financial institution approved by the Government which provides the guarantees called for in the contract documents.
Grader:	It is a machine provided with an adjustable blade or scraper within the wheel base for shaping the road, sub grade or subsoil by loosening or moving the superficial materials laterally. It is either self-propelled or is toed by a tractor.
Hardcore:	It is a consolidated layer of broken stone, brick, slag or concrete in sizes of about half a brick, with some proportion of smaller material.
Highway:	It is an important road in a road system.
Hoggin:	It is the term used for fine sand, earthy gravel, moorum, or other fine material, that forms the slurry grout in water-bound macadam surfaces.
Haul (Lead):	The total distance through which material is transported.
Hopper:	It is a funnel-shaped storage receptacle, through which material can be measured or periodically discharged.
Interchange:	A grade separated intersection with one or more turning roadways for travel between intersecting legs.
Intersection:	The general area where two or more roads join or cross, within which are included the roadway and roadside facilities for traffic movements in the area.
Ignition point (Burning point):	It is the temperature at which the vapor of a substance takes fire and continues to burn, under specified conditions of test.
Island:	It is a central or subsidiary area in a carriageway at road junctions, shaped and placed so as to constrain and control traffic movement.
Joint filler:	A strip of compressible material used to fill the space in an expansion joint.
Jumper:	It is a heavy bar chisel or drill worked either by hand or by means of a hammer, used in making blasting holes in rock.
Curb (Web):	A border of bricks, stone, concrete or other rigid material formed at the edge of a roadway.
Lake Asphalt:	It is an asphalt which is found in nature and is in a condition of flow or fluidity.

Lay-by:	It is the term used for the local widening of a carriageway to enable vehicles to draw off the road for temporary parking or stoppage without obstruction to traffic flow.
Lead, Haul, run:	It is term used for the distance over which excavated material is transported (or carried) for use as filling or to a hank.
Lean:	It is term used opposite to "Fat", i.e. containing a deficiency of bituminous material, Or conversely, the containing of excess of aggregate.
Leveling Course:	It is a course placed for the purpose of shaping old surface to proper cross-section to receive a subsequent surface course.
Liquid Seal:	It is a term used to indicate that the material used for dressing is in a liquid form and does not require to be heated.
Lack spit (Daghel):	It is term used for a narrow continuous V shaped cut made in the ground surface along a defined line of demarcation.
Loop Road:	It is term used for a rout formed by a road or a series of roads to avoid an obstruction or provide an alternative way for traffic.
Liter / Liter:	One thousandth part of a cubic meter (1000 ml)
Loam:	Soil consisting of a natural mixture of clay, sand and silt.
Macadam:	This term applies to broken stone, road stone or road metal: Crushed or broken stone or regular size below 75 mm for road construction.
Mastic Asphalt	<p>This name applies to asphalt or bitumen heated and mixed with fine mineral fillers (lime-stone powder, sand or chipping, etc.) to form a coherent void less impermeable mass, solid or semi-solid under normal temperature and of such consistency that it can be spread when hot by hand 25 mm to 50 mm thick with wooden floats and sets on cooling to give a firm impervious surface. The bitumen has 8 to 10 % of sand. The mastic is laid at a temperature of 160° to 175° V. on a prepared surface. Chippings are spread over the laid asphalt where the thickness is over 12 mm or under heavy traffic to reinforce the mastic, and compacted.</p> <p>Mastic asphalt is said to be much more durable than the ordinary asphalt and easily excavated unlike concrete. It is good for road surfacing during monsoons. It is more durable at road junctions and traffic rotaries where there is higher acceleration, retardation and load bearing; around collars of manholes which wear away very fast; and an extra coat on pedestrian footbridges.</p>

Matrix:	It is a term used for a binding material in which the larger particles of mineral aggregate are embedded.
Median Strip:	It is a name applied to a dividing strip in the middle of a roadway.
Maintenance period:	The period during which a contractor may be required to maintain at his own expense the contract works after completion.
Major road:	A road which has, or to which is assigned a priority of traffic movement over that of other roads.
Minor road:	A road which has, or to which is assigned, lesser priority for traffic movement than that of a major road.
Median:	The portion of a divided highway or street separating the carriageways for traffic movement in opposite directions.
National Highway; Provincial Highway; District Road:	It is the classification of roads by an Authority usually termed as NHA. FHA etc. National highways are the most important roads connecting capital cities of different states (or provinces). Provincial highways are the main roads within state connecting important towns of the state. District roads are of lesser importance than provincial highways.
Overhaul:	The distance of the Haul in excess of the free Haul.
Pavement:	It is the hard crust placed on the soil formation after the completion of the earthwork.
Paving:	A term used for separate blocks or units (usually stone, cement concrete or wood blocks) fitted closely together over a road to serve as a surface.
Picking:	A term used for loosening of the top surface of a road by pick axes or similar tools. Pitch or Coal Tar pitch is the black or dark brown solid or semi solid residue from partial evaporation or distillation of tars.
Pot-holes:	A term used for marked local depressions in a surface layer. Roughly circular in plan, arising from the wearing away of material by traffic or by some other agent.
Prime Coat:	A term used for the initial application of a binder to an absorbent highway surface prior to the construction of a wearing coat.
Primer:	A term used for a binder of low viscosity which on application to a surface, other than a black-top surface, is completely absorbed. Its purpose is to water-proof the existing surface and prepare it to serve as a base for the construction of a black-top surface. A primer may be

road oil, cut-back asphalt or a low viscosity road tar. Some volatile oil is mixed with bitumen to make it less viscous and more highly penetrative binder. A coat of primer is given over dusty, porous or soft roads (such as moorum, kankar, soft sandstone, laterite, limestone, brick aggregate) before applying bitumen, as it will not bind to a dusty surface. The function of a primer is to penetrate into the road and to coat the blind age thoroughly up to a depth of 25 to 40 mm.

Penetration macadam:	Macadam constructed with application of bitumen by penetration process.
Profile grade:	The grade intersecting the top surface of the proposed wearing surface, usually along the longitudinal centerline of the roadbed.
Radial Road:	A term used for a road which provides direct communication between the centre of an urban area and the outer districts.
Ramp:	It is a short steeply inclined way connection surfaces at different levels. Generally made for repair platforms. Maximum rise 1 in 6, prefer 1 in 7.
Refuge:	It is a raised pavement or platform, or a guarded area, so sited in a carriageway as to divide the, streams of traffic and to provide a safety area for pedestrians. (Usually provided at the entrance of radial roads to rotary carriageway).
Right-of-way:	This term is used for: - <ol style="list-style-type: none">i. The land secured and reserved for development of a road and all structures pertaining to the road.ii. The privilege of use of a way, acquired by the traffic by law, custom or usage.
Ring Road:	A term used for a circumferential road built around an urban area enable free flow of traffic.
Road:	A term used for a way for vehicles and for other types of traffic over which they may lawfully pass. It includes the entire area comprising the roadway and all structures pertaining to the road within the limits of the defined boundary or "right-of-way".
Road oil:	A term applied to various types of liquid or cut-back asphalt, heavy oil, etc., which are applied to road surface to lay dust, or for surface treatments.
Road way:	It is that portion, of a road (included within the construction limits) ordinarily used for traffic. I included carriageway and shoulders.

Rock Asphalt:	It is the natural rock formation, usually of lime-stone or sand-stone, impregnated with bitumen throughout its mass.
Rolled Asphalt:	It is a dense mixture of stone, sand, filler and bitumen mixed and laid hot, and consolidated by rolling while still warm.
Rubble:	These are pieces of stone or broken brick or concrete of irregular size and shape.
Rut:	It is a groove or depression formed in a surface layer longitudinal to the road by the wheels of traveling vehicles.
Retaining wall:	A wall constructed to resist lateral pressure from the adjoining ground, or to maintain in position a mass of material usually the road embankment.
Revetment (Pitching):	A facing of stone or other material laid on a sloping face of earth to maintain the slope in position or to protect it from erosion.
Road Formation:	The width of a road on top consisting of pavement and shoulders.
Sag:	It is a term used for a hollow or a depression formed by the junction of two falling gradients.
Sand Paper Surface:	It is a rough surface texture for road surfacing produced by the pressure of protuberant sharp particles of mineral aggregate which are not larger than about 6 mm size.
Scarifying:	It is the loosening of the top surface of a road by mechanical or other means.
Screenings:	It is the small size stone particles sieved through the lowest mesh of 6 mm prescribed for chipping sizes.
Seal Coat or Scaling Coat:	<p>It is a term used for dressing of tar or bitumen blinded with grit, etc. applied to open textured bituminous surfaces to render the surface watertight and strengthen the macadam. This may be with pre-coated clippings and applied as surface dressing. The thickness is about 12 mm and the size of grit used varies from 10 mm down to sand. A seal coat is more or less like a renewal coat of surface dressing.</p> <p>It should be the aim of the engineer to avoid the necessity of a seal coat in order to reduce the cost. Grading of aggregate and addition of fine material to the mixture achieves this object.</p>
Service Road:	<p>This term is used for: -</p> <ol style="list-style-type: none">i. A subsidiary road constructed between a road and buildings or properties facing thereon and

connected only at selected points with the principal road.

- ii. A way at the back of buildings for servicing and providing other means of access.

Sheet Asphalt:

A pre-mix of bitumen (with or without filler) and sand, and containing coarse aggregate not exceeding 30%. This is really a dense carpet where stone metal is discarded and chippings limited to 30%, the rest being sand. Sheet asphalt is laid in thicknesses varying from about 20 to 40 mm.

Shingle:

It is a name used for coarse rounded or water-worn stones, detritus or pebbles larger than gravel and smaller than boulders and is available in hill streams.

**Shoulder, Haunch
or Berm:**

This term is used for: -
The portion immediately beyond the edges or a carriageway (usually of earth unmetalled) on which vehicular traffic may pass occasionally (while crossing). The strip of land between side drain and the lower edge of bank.

Side Ditch:

It is a roadside drain or channel provided at the toe of a road bank.

Sad:

It is term used for a rectangular piece of turf.

Spoil:

It is term used for surplus excavated material.

**Spoil Bank,
Tip, Shoot:**

it is term used for an earthwork bank formed by depositing spoil (outside the limits of the works).

**Stock Subway
or Cattle Creep:**

It is a term used for a shallow subway constructed to permit passage of cattle underneath a road or a railway.

**Straight-run
Bitumen:**

It is a term used for steam-refined bitumen. Bitumen made by the straight distillation of suitable crude oils; steam is injected into the oil so that the distillation is carried out at a lower temperature.

Street:

It is a road in built-up area.

Stripping:

It is the preliminary operation of clearing the site of the work of surf, grass, weeds, brushwood and other extraneous material.

Sub-crust:

It is an intermediate layer acting as cushion between the pavement.

Subway:

It is an underground passage or tunnel to permit the movement of traffic, or to accommodate service pipes, cables, sewers etc.

Summit	It is term used for a peak formed by the junction of two rising gradients.
Super-elevation, Banking or Cant:	It is a term used for the inward tilt or transverse inclination given to the cross-section of a carriageway on a horizontal curve to reduce the effects of centrifugal force on a moving vehicle.
Safety Fence:	a) A fence erected to prevent vehicles from leaving the carriageway at a dangerous place. b) A fence erected for the safety of pedestrians c) A fence on a highway to prevent any specified type of traffic from leaving the part of highway appropriate to its use.
Section (Cross):	A vertical section at right angles to the center line, showing the elevation of the ground.
Section (Longitudinal):	A vertical section showing the elevation of the ground usually along the center line.
Site:	The land and other places provided by the Department for the execution of the work.
Site Engineer:	The onsite representation of the contractor duly authorized to receive and execute all instructions of the Engineer and to supervise and direct all of the contractor's construction operations in all phases of the work.
Special specifications:	Additions and revisions of the General and Supplemental Specifications covering conditions peculiar to an individual project
Specifications:	A general term applied to all directions, provisions and requirements pertaining to the performance of the work.
Stabilized soil:	Any natural material which has been modified to improve and maintain its load carrying capacity and resistance to weathering.
Structures:	Bridges, culverts, catch basins, catch pits, drop in lets, retaining walls, cribbing manholes, end walls, buildings, sewers, service pipes, under drains, foundation drains and other features which may be encountered in the work and not otherwise classified herein.
Sub-contractor:	An individual firm or corporation to whom the contractor sublets part of the work.
Sub-grade surface:	The top surface of a road-bed upon which the pavement structure and shoulders are constructed.
Subgrade surface limit:	The limits of the road-bed which are included in the designation sub-grade, shall be taken as extending to

full embankment width in fills and to full formation width in cuts to a depth of 30 cms (1 foot) below sub base.

Sub-Base:	A layer of material provided between the subgrade and the base, for a special purpose e.g. drainage or to add strength to the pavement.
Subgrade Level:	That level of roadbed on which road material has to be placed.
Sub grade treatment:	Modification of roadbed material by stabilization.
Substructure:	All of that part of the structure below the bearings of simple and continuous spans, skewtacks of arches and tops of footings of rigid frames, together.
Superstructure:	The entire structure except the substructure.
Supplemental specifications:	Additions and revisions to the General specifications that are adopted subsequent to issuance of the printed book.
Super elevation:	The inward tilt or transverse inclination given to the cross section of a carriageway throughout the length of a horizontal curve to reduce the effect of centrifugal force on a moving vehicle.
Surety:	The corporation, partnership or individual, other than the Contractor, executing a Tender Guarantee furnished by the Contractor.
Surface course:	One or more layers of a pavement structure designed to accommodate the traffic load, the top layer of which resists skidding, traffic abrasion and the disintegrating effects of climate.
Surface dressing:	The surfacing process consisting of the application of bituminous binder and cover aggregate to an existing road surface.
Surface treatment:	One or more applications of bituminous.
Scarifier tyne:	It is a term used for the pointed steel bar or rod acting as the cutting unit of a scarifier.
Scoop:	It is a machine consisting essentially of a bucket or shallow container with a cutting edge, designed to excavate, load and transport over relatively short distances, and clump, soft or previously loosened material.
Scraper:	It consists of a large scoop with cutting edge. It excavates, transports and dumps the material where required. The cutting blade maintains a constant digging depth.

Screed:	It is a full-sized mould, pattern or frame shaped to serve as a guide in forming or testing contour or shape.
Tack Coat:	It is the term used for the initial application or a hinder to an existing surface given to ensure thorough bond between the new construction and the existing surface.
Track ways:	It is the term used for a carriageway in which wearing surface is provided on the wheel tracks only (usually of bricks, stone or concrete slabs).
Traffic Density:	These are the number of vehicles using the road per hour during peak periods and is the average of several peak days. The daily traffic is approximately ten times the maximum hourly traffic.
Traffic Lane:	It is taken as unit or width of a carriageway and which supposed to accommodate only a single line of vehicular traffic; while crossing, vehicles have to use berms.
Transition Length:	It is the length of the transition curve connecting straight length of a road with another main curve which may be circular transitional.
Trunk Road, Arterial Road:	It is a term used for a main channel or traffic route which forms an essential part of the highway system of the country.
Tractor:	It is a self-propelled powerful attractive machine which is used either for towing other machines or equipment's are fixed to it to form a self-sufficient unit. This machine is carried either on wheels or crawler track. A crawler track is a device consisting of an endless chain of plates which bear upon the ground and this device is used in place of wheels.
Turf:	It is the surface of grass land consisting of earth or mould filled with matted roots of grass and other herbs.
Tender:	The bid or offer made by a bidder, on the prescribed form, to perform the works and to furnish the labour and materials at the prices quoted.
Tender documents:	The approved form on which the Department requires Tenders to be prepared and submitted for the work.
Tender guarantee:	The security furnished with a Tender to guarantee that the bidder will enter into a contract if his Tender is accepted, and includes the specified forms on which the Contractor shall furnish required information and to his ability to perform and finance the work.
Ton:	The word "Ton" used in the specifications designates the long ton of 2240 lbs.

Tonne (Metric ton):	Equivalent to 1000 Kilograms (2204 lbs)
Unmetalled (Roadway):	Unsurfaced, unpaved (roadway)/dirt road.
Variation Order:	A document compiled to include changes, substitutions and additional work items not covered in the B.O.Q, for the sanction of the competent Authority and shall include increase or decrease in quantities or rates also.
Water-bound Macadam:	It is a term used for the surface layer of a road in which the road metal has been consolidated with water and earthy material or rock particles. A type of surfacing in which stone fragments are first interlocked by rolling and then bound with smaller stone, gravel, etc., which is forced into the interstices by brooming, watering and rolling.
Weaving Length:	It is the length of a carriageway between adjacent radial routes around a traffic roundabout.
Water table:	The level at which ground water would finally stand in an un-pumped borehole, well or other depression, when equilibrium has been reached.
Wearing course:	The top layer of the bituminous concrete, which carries the traffic, resists skidding, surface abrasion and the disintegrating effects of climate.
Weep hole:	A small aperture or pipe through a retaining wall or abutment which, by using as a drain, prevents the accumulation of water.
Work:	The work shall mean the furnishing of all labour, materials, equipment and other incidentals necessary or convenient to the successful completion of the project and the carrying out of all the duties and obligations imposed by the Contract.
Wagon (railway):	A railroad freight car.
Wayleave:	Permission to Cross land, right of entry as defined in the land acquisition act of the Government of Pakistan.
Well:	A concrete or masonry caisson incorporated in foundations.
Working day:	A working day shall be any day on which the Contractor can physically and legally execute the work.
Working drawings:	Stress sheets, shape drawings, execution plans, work plans, framework plans, plans for bending of reinforcing steel, or any other supplementary plans, or similar data which the contractor is required to submit to the Engineer for approval.

Written Undertaking:

A written promise.

Zone (safety):

A raised pavement or platform, or a guarded area so situated in a carriageway as to divide the stream or traffic and to provide a safety area for pedestrians.

16.2 Earthwork for Roads

Please also refer to the Heading “3.9” of Book-2 of these specifications.

16.2.1 Subgrade Preparation

- The subgrade preparation shall be that part of the work on which, the subgrade is placed or, in the absence of subgrade, act as the base of the pavement structure. It shall extend to the full width or the road bed.
- Before commencing the work, all culverts, drains, ditches including fully compacted backfill over them outlets for drainage, head walls/wing walls of culverts and any other minor structure which would be below 30cm of newly placed subgrade level, shall be in such operative conditions as to ensure prompt and effective drainage and to avoid damage to subgrade by surface water. No work of subgrade preparation would be started before the prior work.
- All materials down to a depth of 30cm below the subgrade level in earth cut or embankment shall be compacted to at least 95% or the maximum dry density us determined according to AASHTO T-180 Method 'B' or 'D' whichever is applicable, or corresponding Relative Density as per D-4254-83 (ASTM).

16.2.1.1 Construction Requirement

16.2.1.1.1 Prior Work

Before commencing the work all culverts, drains, ditches including fully compacted backfill over them outlets for drainage, head walls/wing walls of culverts and any other minor structure below thirty (30) Centimeters(12 inches) of existing sub-grade level or all structures which will be below thirty (30) Centimeters of newly placed subgrade level, shall be in such operative conditions as to ensure prompt and effective drainage and to avoid damage to subgrade by surface water. No work of subgrade preparation will be started before the prior work herein described has been approved by the Engineer.

16.2.1.1.2 Compaction Requirements

All materials down to a depth of 30cm (12 inches) below the subgrade level in earth cut or embankment shall be compacted to at least 95 percent of the maximum dry density as determined according to AASHTO T-180 Method “D (Modified). or corresponding Relative Density as per D-4254-83(ASTM).

16.2.1.1.3 Subgrade Preparation in Earth Cut

- In case bottom of subgrade level is within thirty (30)cm (12 inches) of the natural ground, the surface shall be scarified, broken up, adjusted to moisture content and compacted to minimum density of Ninety Five (95) percent of the maximum dry density as determined by AASHTO T-180 Method-D. Subsequent layer of approved material shall be incorporated to ensure that the depth of subgrade layer is thirty (30)cm (12 inches.)
- In case, the bottom of subgrade is below the natural ground by more than thirty (30) cm, (12 inches.) the material above the top of subgrade shall be removed and subsequent layer of thirty (30) cm (12 inches.) shall be scarified, broken up, adjusted

to moisture content and compacted to the same degree of compaction as described above.

- Subgrade preparation process shall be carried out in two layers of fifteen (15) cms (6 inches) each. Layer thickness could be increased to 30 cms (12 inches) to prepare the subgrade in one-layer subject to the availability of adequate equipment and to the satisfaction/instruction of the Engineer, provided that the compaction of 95% of the modified dry density is ensured for the whole depth.
- In case, unsuitable material is encountered at the subgrade level within a depth of 30cm, the same shall be removed in total and replaced by the approved material. The Contractor shall be paid for removal of unsuitable material and for replacement of approved material, the payment would be made under the relevant pay item mentioned in the BOQ.

16.2.1.1.4 Subgrade Preparation in Rock Cut

- Excavation in rock shall extend to the subgrade level as shown on drawings. Rock shall be undercut nearly to required elevation and sections shown on the plans or as directed by the Engineer. Transverse and longitudinal profiles checked by template shall be accurate. to the requirement. Cuts below subgrade level shall be backfilled with selected sub-base material and compacted to minimum 98% of the maximum dry density as determined by AASHTO T-180 Method 'D'.
- No rock shall be higher than 2cm above the undercut section elevation. The undercut material shall be placed in embankment or disposed of.

16.2.1.1.5 Subgrade Preparation in Embankment

- When the subgrade is formed in embankment, its width shall be the full width of top of embankment and material placed in the upper part of embankment down at a depth of 30cm below subgrade level shall meet compaction requirement of Section 'Subgrade Preparation' under sub heading 'Compaction Requirements'. Soil having a minimum value of C.B.R of 7% and swell value or not more than 0.3% shall be used. C.B.R less than 7% may be used in case, the design allows for it. Unsuitable material if encountered within the existing formation layer as per laboratory specified test, shall be removed; disposed of and replaced by suitable one as per direction of the Engineer of which the payment would be made under relevant items of work.
- Rollers and other equipment's of approved size and type, accepted by the Engineer, shall be used for compaction. Water shall be added to obtain optimum moisture content; if necessary. Contractor shall ensure proper compaction in restricted areas by use of special equipment's and rollers. No compensation shall be made for extra work due to restricted space.
- Performance of this item of work shall not be paid for under this section but shall be deemed to be covered by the contract price for pay item in this volume under Chapter-3 "P. Formation of Embankment".

16.2.1.1.6 Subgrade level in Existing Road

If existing road surface is to be used as the subgrade, the correct elevation on which the base or sub-base is to be laid shall be obtained, where necessary, either by means of approved leveling course or by excavation. Excavation shall include disposal of any surplus material in the adjacent embankment.

16.2.1.1.7 Subgrade Reinforcement

- When the width of the existing pavement, either to be scarified or not, is insufficient to contain the subbase or base to be placed upon it, the Engineer may order to strengthen and support the subbase or base on one or both sides of the existing pavement. This work shall consist of the removal and disposal of any unsuitable material and its replacement with suitable material to such width and depth as required by the Engineer.
- The excavated material shall, if declared suitable for use elsewhere in the embankment by the Engineer be so used, and payment for its removal shall be covered under the contract price of the relative pay item of the Chapter-3 Making/Formation of Embankments as the case may be.
- If declared unsuitable it shall be disposed off and paid as provided in the chapter-3 Road Excavation. The compaction and the finished compacted surface of the subgrade shall be as specified in the above sections item.

16.2.1.1.8 Protection of Completed Work

Any part of the subgrade that has been completed shall be protected and kept well drained. Any damage resulting from carelessness shall be repaired. Subgrade preparation and sub-base or base placing shall be arranged to follow each other closely. The subgrade, when prepared too soon in relation to the placing of the sub-base, is liable to deteriorate, and in such case, it shall be restored.

16.2.1.1.9 Templates and Straightedges

The Contractor shall provide for the use of the Engineer, satisfactory templates and straightedges in sufficient numbers to check the accuracy of the work, as provided in these specifications and no subsequent work shall be permitted until the subgrade levels have been checked and approved by the Engineer.

16.2.1.2 Measurement and Payment

16.2.1.2.1 Measurement

The quantity to be paid for shall be the number of square meters or square feet of sub-grade prepared as herein before prescribed and accepted. Subgrade in rock cuts and on embankment not consisting of the existing road surface in fill area shall not be measured for direct payment. Sub-grade preparation on "Existing Surface" shall only be measured for payment when ordered by the Engineer.

16.2.1.2.2 Payments

The quantities, determined as provided above, shall be paid for at the contract unit price for the pay item listed below and shown in the Bill of Quantities which prices and payment shall be full compensation for furnishing of material, water, equipment, tools, labour, and all other items incidental to and necessary for completion of this work.

Pay item Number	Description	Unit
16.2.1.2.2.1	Subgrade preparation in Earth Cut	m ² or 100 sft
16.2.1.2.2.2	Subgrade preparation in Existing Road: -	
	i. Subgrade preparation Without any fill	
	ii. Subgrade preparation with fill less than 30 cms	m ² or 100 sft

		m ² or 100 sft
--	--	---------------------------

16.2.2 Improved Subgrade

16.2.2.1 Description

This work shall consist of the formation of the roadbed, under subbase or base course as the case may be, with an approved blend of materials, uniformly mixed, compacted, shaped and finished to the lines, grades and typical cross-sections shown on the Drawings, or in thickness as directed by the Engineer. Improved subgrade as herein referred to may be defined as material suitable for embankment to which better quality of material is blended in proper proportion to improve its strength properties or performance.

16.2.2.2 Material Requirements

The major component of improved subgrade shall consist of material conforming to "Material requirements for embankment." The blending material shall be any soil that classifies as A-1(a), A-1(b), A-2-4 or A-3 according to AASHTO M-145 with PI of not more than 6. The blended mixture when compacted to ninety-five (95) percent of the maximum dry density determined by AASHTO T 180-D Method, shall exhibit a laboratory soaked CBR (96 hours) of not less than 20, or as specified in the drawings.

16.2.2.3 Construction Requirements

16.2.2.3.1 Preparation

The surface of the roadbed on which the improved subgrade is to be constructed shall be compacted to the density specified for it.

16.2.2.3.2 Proportioning of Material

Prior to start of construction, the proportion of each material to be incorporated for improved subgrade shall be established. The blended proportions thus established shall apply only when each material to be used is obtained from same source. Shall a change in source of material be made, a new proportion shall be established. When unsatisfactory results or other conditions make it necessary, additional laboratory tests may be required.

16.2.2.3.3 Mixing and Spreading

Improved Subgrade may be constructed with any combination of machines or equipment that would yield results meeting the required specifications

1. Stationary Plant Method

The soil ingredients and Water shall be mixed in an approved mixing plant (Plug Mill). The plant shall be equipped with feeding and metering devices that would add the materials to be blended in the specified quantities. Water shall be added during the mixing operation in the quantity required for proper compaction, which is approximately optimum moisture content plus or minus 2%. The mixing time shall be that which is required to secure a uniform mixture. After mixing, the blended material shall be transported to the job site while it contains sufficient moisture and shall be placed on the roadbed by means of an approved mechanical spreader. The mixture shall be spread at rate that would produce a uniform compacted thickness

conforming to the required grade and cross-section. Compaction shall start as soon as possible after spreading and shall continue until the specified relative compaction is achieved.

2. Traveling Plant Method

The traveling plant shall be either a flat transverse shaft type or a window type pugmill. After the materials have been placed by a mechanical spreader or window sizing device the materials shall be uniformly mixed by the traveling mixing plant. During the mixing operation water shall be added as necessary to bring the moisture content of the mixture to the percentage suitable for proper compaction.

3. Road Mix Method

The materials shall be transported to the site and spread in layers on the roadbed in the quantities required to produce the specified blend. After the materials for each lift have been spread, the materials shall be mixed by motor graders and other approved equipment until the mixture is uniform throughout. During mixing operation, water shall be added as necessary to bring the moisture content to the required percentage.

16.2.2.3.4 Compaction

Each layer of improved subgrade shall be placed in horizontal layers of uniform loose thickness not exceeding 20cm. Each layer shall be compacted to the density conforming to the requirements specified. (In-place density determinations of the compacted layers shall be made in accordance with AASHTO T-191, T-238 or other approved methods.)

16.2.2.3.5 Trial Section

The object of these trials is to determine the proper moisture content, the relationship between the numbers of passes of compacting equipment, density obtained for the blended material, and to establish the optimum lift thickness that can be effectively compacted with the equipment used. Prior to the formation of the improved subgrade, the Contractor shall construct three trial sections of 200m length 1 for each blend of, improved material proposed to be incorporated for improved subgrade, or as directed by the Engineer. The compacting equipment to be used in the trial sections shall be the same equipment that the Contractor intends to use for main work, accepted by the Engineer

16.2.2.3.6 Protection of Completed Work

- Any part of the completed improved subgrade shall be protected and well drained and any damage shall be repaired.
- The Contractor shall be responsible for all the consequences of traffic being admitted to the improved subgrade. He shall repair any ruts or ridges occasioned by his own traffic or that of others by reshaping and compacting with rollers of the size and type necessary for such repair. He shall limit the improved subgrade preparation to an area easily maintained with the equipment available. Subgrade preparation and placement of succeeding layer to follow each other closely. The improved subgrade, when prepared too soon in relation to the placing of the layer above it, is liable to deteriorate, and in such case the Contractor shall, without additional payment repair, reroll, or recompact the improved subgrade as may be necessary to restore it to the specified herein.

16.2.2.3.7 Templated and Straightedges

The contractor shall provide for the use of Engineer, satisfactory templates and straightedges in sufficient numbers to check the accuracy of the work, as provided in these specifications and no subsequent work shall be permitted until the improved subgrade level have been checked and approved by the Engineer.

16.2.2.3.8 Tolerance

The allowable tolerances for the finished improved subgrade surface prior to placing the overlying subbase, base or asphaltic concrete course are given in the relevant, "Table for Allowable tolerances" in these specifications.

16.2.2.4 Measurement and Payments

16.2.2.4.1 Measurement

The quantity of improved subgrade to be paid for shall be measured in cubic meter or 100 cubic feet by the theoretical volume in place as shown on the Drawings, placed and accepted in the completed improved subgrade.

16.2.2.4.2 Payment

The accepted quantities measured as provided above shall be paid for at the contract unit price per cubic meter or per 100 Cft of improved subgrade for the pay item listed below and shown in the Bill of Quantities, which price and payment shall constitute full compensation for furnishing all materials, hauling, mixing, placing in layers, watering and compacting, labour equipment, tools and incidentals necessary to complete the item.

Pay item Number	Description	Unit
16.2.2.4.2.1	Improved Subgrade	M ³ or 100 Cft

16.2.3 Soil Cement Stabilized Subgrade

16.2.3.1 Description

- The work shall consist of performing all operations in connection with the formation of soil cement stabilized subgrade and all incidentals in accordance with the Specifications and in conformity with the lines and level, grade and typical cross-sections shown on the plans of the concerned drawings.
- The mix in place method of construction shall only be applied to sites with naturally occurring sand, gravel or sand and gravel mixture. For the stationery plant method of construction, the materials shall comply with the Specifications or materials from any other source selected by the Contractor shall be subject to the Engineer's approval.

16.2.3.2 Material Requirements

1. Soil

Soil used for cement stabilization shall be either "Silty or Clayey Soils" or sandy and gravelly soils with the following characteristics: -

i. Silty and Clayey Soils

When this type of soil is used for cement stabilization, it shall fulfill the following requirements:

-

➤ Liquid Limit (Max)	45%
➤ Plastic Limit (Max)	20%
➤ P.H. Value	Not less than 12
➤ Soluble Sulphate Content max	4%
➤ Soluble Chloride Content max	8%

If the soil at site does not have P.H. value specified above, it shall be improved by adding calcium chloride up to 2% by weight of the dry soil.

ii. Sandy and gravelly Soils

Sandy and gravelly soils used for cement stabilization shall fulfill the following requirements: -

➤ Passing maximum size fifty (50) mm sieve	100%
➤ Passing five (5) mm (No. 4) sieve	above 50%
➤ Passing 0.4 mm (No. 36) sieve	above 15%
➤ Passing 0.075 mm (No. 200) sieve	below 5%
➤ Finer than 0.002 mm (Clay)	below 3%

2. Cement

- The Cement to be used for stabilization shall be Portland cement or sulphate resistant cement as directed by the Engineer according to the results of laboratory tests. Portland cement shall conform to requirement of AASHTO M-85 while sulphate resistant cement shall conform to requirement of AASHTO M-74.
- Immediately upon arrival to the site, the Cement bags shall be stored in weather proof building to protect from dampness on raised platform. At the time of use, all cement shall be free flowing and free of lumps. Under normal circumstances cement shall not be stored for a period longer than 4-months. Any cement that has remained in store for a period in excess of 4-months, or of which there is any doubt as to its quality, shall be attested for Specification requirements. No such cement shall be used in the works without the approval of Engineer.

3. Water

Water to be used shall be free from injurious quantities of oil, alkali, vegetable matter and salts. It shall not contain more than 1000-parts per millions (ppm) of sulphates. In no case, water shall contain impurities to the extent that would cause change in setting time of cement by more than 25% nor reduction in compressive strength of mortar after 14-days by more than 5% when compared to results obtained with distilled water.

4. Mix Design Requirement in Laboratory

Before starting the work of stabilization, the proposed mix design showing exact percentage of cement and water to be used so as to obtain a mixture, shall be submitted by the Contractor for the approval of Engineer. The mix proportions shall be such so as to satisfy the following requirements: -

- Mixture sample, stored in box, with maximum humidity of 95% for 24-hours and submerged in water for 2-hours before crushing, shall have a minimum compressive strength of 17 kg/cm².
- The maximum permissible swelling of volume shall be 2% and maximum loss in weight 8% when tested in accordance with the AASHTO T-135.
- Maximum permissible tolerance of cement and water content during construction shall be as under: -
 - Cement Content: Tolerance +1% of that given in the mix design.
 - Water Content: 0 to +2% of that given in the mix design.

5. Composite of Mixture at site

Soil shall be mixed with sufficient cement to obtain required crushing strength. The cement content shall be determined at the laboratory so that minimum compressive strength of mixture is 30 kg/cm² at 7-days. The moisture content of the mix cement stabilized material shall not be less than the optimum as determined by AASHTO T-134 Method and not more than 2% above the optimum as determined by this test or such higher value as may be agreed by the Engineer on basis of preliminary trial.

16.2.3.3 Construction Requirement

16.2.3.3.1 Mix in Place Method

- The field equipment's used for pulverizing and mixing the stabilized material shall be approved by the Engineer on the basis of preliminary trials to ensure that the plant is capable of producing the required degree of mixing and uniformity of stabilized material to the full thickness of layer being processed. The mixers shall be equipped with a device of controlling the depth of processing and the mixing blades shall be maintained so that correct depth of mixing is obtained at all times. The cement shall be spread ahead of mixer by means of a cement spreader, fitted with a device to ensure a uniform and controllable rate of spread of cement both transversely and longitudinally.
- Water shall be added to adjust moisture content of material to optimum for compaction using water sprayer in uniform and controllable manner both transversely and longitudinally.
- The mixing machine shall be set so that, it slightly cuts edge of adjoining lane processed previously to ensure proper processing of all material throughout the depth of layer. The output of the mixing plant shall not be less than 25m/hr measured longitudinally of completed stabilized layer in order to achieve satisfactory compaction.

16.2.3.3.2 Stationary Plant Method

- The stationary plant shall be of the power-driven paddle or pan type and may be of the batch or continuous type. In case the batch mixes are used, the appropriate measured quantity of material and cement shall first be placed in the mixer and then mixer water be added as necessary to bring the moisture content of the resulting mixture within the range specified above.
- Care shall be taken with batch type paddle mixers to ensure that the cement is spread uniformly in the loading skip so that it is fed evenly along the mixing trough and that with both paddle and pan mixers, the cement is proportioned accurately by separate weighing or proportioning device from that used for the material being stabilized. Mixing shall be continued until the mixture has the uniformity and mixing time would be less than 1-minute.

16.2.3.3.3 Compaction

- Any modification to meet the Specifications shall be completed together with compaction, within 1½-hours after mixing, or making good to deficient areas at Contractor's expense. Thickness shall be as shown on the drawings or as directed by the Engineer and shall comply the following requirements.
- Immediately after spreading and shaping operation, the mixture shall be thoroughly and uniformly compacted with approved rollers. Rolling shall continue until entire depth nod width of subgrade is uniformly compacted to maximum density or 95% as tested in accordance with modified AASHTO T-134. Compaction shall be completed as soon as possible after mixing, normally within three hours, depending mainly on setting time of concrete and weather conditions.
- Compaction shall not be carried out after cement hydration and any soils material, which has been mixed or deposited after cement hydration, shall be removed and replaced with fresh mixed material.
- After compaction, stabilized subgrade shall be protected against drying but by keeping it continuously damp or wet for a period of at least 3-days or by coating with approved curing material. Surface shall be maintained in an acceptable condition at all times prior to the construction of sub-base.
- No vehicular traffic shall run on the stabilized subgrade within a minimum curing period of 7-days.

16.2.3.3.4 Tolerance

Tolerance in the thickness of compacted layers shall conform to as specified in the relevant, "Table for Allowable Tolerances" in these Specifications.

16.2.3.4 Measurement and Payment

16.2.3.4.1 Measurement

The unit of measurement for payment shall be "m³" of completed and accepted subgrade as measured in place. Measurement shall not include any areas in excess of that shown on the drawings, except the areas authorized by the Engineer in writing. Measurement of cement content used shall be the number of metric Ton used to stabilize subgrade. This quantity of Cement consumed shall not exceed the theoretical percentage established in the laboratory.

16.2.3.4.2 Payment

The measured quantity of stabilized subgrade determined as above shall be paid for at the contract unit-price/m³ for a particular item listed below and shown on the BOQs, which payment shall be full compensation for furnishing all labour, material, tool, plant, equipment, handling, mixing manipulating, placing, shaping, compacting, including necessary water for compaction, rolling, finishing, correcting unsatisfactory areas and unsatisfactory material; maintenance including protection of stabilized layers; and incidentals necessary for completion of work except cement consumed which shall be paid separately as measured above.

16.2.4 Lime Stabilized Subgrade

16.2.4.1 Description

The work consists of performing all operations in connection with construction of lime stabilized subgrade and all incidentals in accordance with these Specifications and in conformity with lines and level, grade and typical cross-sections shown on the plans or as directed by the Engineer.

16.2.4.2 Material Requirement

1. Soil

Naturally occurring heavy clay soils, clayey gravels or soils containing a sufficient proportion of clay or silty clay to enable satisfactory stabilization with lime shall be required for the "Mix in Place Method" of construction and shall conform to properties as specified in this chapter under Section 'B. Soil Cement stabilized subgrade' under heading '1. Material Requirements'. Materials from any other sources shall comply with the Specification, in case of stationary plant construction method. Lime stabilization has been used successfully in clayey soils having plasticity index, more than 10. This type of stabilization is applicable to that soil which contains a high percentage of clay or silty-clay.

2. Lime

Lime to be used for stabilization shall be calcium hydroxide (slaked or hydrated lime) or Calcium oxide (quick lime) to the requirements for building lime in Chapter-3 of Book-1 (Specification for Engineering Material).

3. Water

Water used for lime stabilization shall be clean and free from injurious substances. Potable water is preferred and organic water is not permitted. It shall neither contain more than 1,000 parts per million of chlorides nor more than 1,300 parts per million of sulphates (SO_4). Water from doubtful sources shall not be used.

4. Mix Design Requirement in Laboratory

The mix design shall be worked out in the laboratory and it shall state the following field requirements: -

- The percentage of lime and water (optimum content and tolerances)
- The field density of lime stabilized mixture to minimum 95% of laboratory density established with modified AASHTO T-134 test.
- The required results of the compressive strength in laboratory at 7-days shall not be less than 10 kg/cm².

5. Composite of Mixture at site

Soil containing clay shall be mixed with sufficient lime; normally 3 to 8% lime content, so that minimum compressive strength is 7 Kg/cm² at 7-days. Moisture content of the lime stabilized material shall be not less than the optimum nor more than 2% above the optimum as determined by Vibrating Hummer method test of BS 1924 (1975). As a guide trials, lime content shall be established starting with 1% lime by weight or dry soil for each 10% of clay in soil.

16.2.4.3 Construction Requirement

16.2.4.3.1 Stationary Plant Method

The construction requirements of this clause shall conform to as specified in 16.2.3 'Soil Cement Stabilized Subgrade'.

16.2.4.3.2 Mix in Place Method

The requirements of construction under this clause shall be in accordance with 16.2.3 'Soil Cement Stabilized Subgrade'.

16.2.4.3.3 Precautionary Measures

Keeping in view the caustic nature of calcium oxide (quick lime), special measures shall be taken in handling, since it would attack equipment corrosively and precautions shall also be taken against the risk of severe skin burns to personnel. Suitable handling methods shall be used such as fully mechanized or bottom dump handling equipment, and protective clothing worn by the operators. Working operations shall take into account the wind direction to minimize the dust problem and consequent eye or skin irritation any personnel involved in the vicinity. Even when calcium hydroxide (slaked or hydrated lime) is used, care must be taken against the effects of prolonged exposure to skin.

16.2.4.3.4 Compaction Requirement

- Immediately upon completion of spreading and shaping operation, the mixture shall be thoroughly compacted with approved roller. Compaction shall be continued until the entire depth of subgrade is uniformly compacted to the, maximum density of 95% as determined by modified AASHTO T-134.
- If quick lime is used, it shall not be permitted to compact the layers immediately after spreading the lime, because the hydration of the lime would cause damage to the compacted layers. The time within which compaction shall be completed would be estimated in the laboratory. Dry density of compacted layers shall not be less than 95% of the maximum dry density determined in laboratory.
- Compaction shall not take place after hydration of lime and any lime stabilized material that has been mixed and deposited after hydration of lime, shall be removed and replaced with fresh material, mixed and treated in accordance with the requirements of this clause.
- Surface of subgrade shall be acceptable in all respects to Specification, together with compaction with 1½-hours after mixing. Contractor would be responsible for any removal of or making good to deficient area without any extra payment. No vehicle or equipment shall be allowed to move over stabilized subgrade before initial setting of 7-days.

16.2.4.3.5 Tolerance

Tolerance in the thickness of compacted layers shall conform to as specified in the relevant, "Table for Allowable Tolerances" in these specifications.

16.2.4.3.6 Weather Limitation

The laying of lime courses shall be avoided as far as practicable during cold and wet weather and shall be suspended when free standing water is present on the surface. The stabilized material shall not be laid on any surface, which is frozen or covered with ice or snow, and

laying shall cease when the atmospheric temperature reaches 5°C. If wet weather threatens to be prolonged, the manufacture and laying of stabilized mix shall be suspended.

16.2.4.4 Measurement and Payment

16.2.4.4.1 Measurement

The unit of measurement for payment shall be cubic meter of 100 cft. of completed and accepted subgrade as measured in place. Measurement shall not include any areas in excess of that shown on the drawings, except the areas authorized by the Engineer in writing. Measurement of cement content used shall be the number of metric Ton used to stabilize subgrade. This quantity of Cement consumed shall not exceed the theoretical percentage established in the laboratory.

16.2.4.4.2 Payment

The measured quantity of stabilized subgrade determined as above shall be paid for at the contract unit price per cubic meter or 100 cft. for a particular item listed below and shown on the bill of quantities, which payment shall be full compensation for furnishing all labour, material, tool, plant, equipment, handling, mixing manipulating, placing, shaping, compacting, including necessary water for compaction, rolling, finishing; correcting unsatisfactory areas and unsatisfactory material; maintenance including protection of stabilized layers; and incidentals necessary for completion of work except cement consumed which shall be paid separately as measured above.

Pay item Number	Description	Unit
16.2.4.4.2.1	Soil Cement stabilized Sub-grade	CM or 100 cft.
16.2.4.4.2.2	Cement content type	Tone

16.2.5 Bitumen Stabilized Subgrade

16.2.5.1 Description

Performing all operations in connection with construction of bitumen stabilized subgrade and all incidentals in accordance with these Specifications and in conformity with lines, grade, thickness and typical cross-sections shown on the plans or as directed by the Engineer.

16.2.5.2 Material Requirement

1. Soil

This method would only apply to sites with naturally occurring non-plastic material such as sand. If the material is brought at site, it shall be non-plastic having uniform gradation.

2. Bitumen

- Bituminous material used for subgrade stabilization shall comply with the requirement as per relevant tables specified in Section 16.4 'Surface Courses and Pavement' under heading '16.4.2 Asphaltic courses'.
- For hot mix asphaltic concrete or can be viscous cut back that requires heating in areas where moisture content of sand is high, necessitating heating and drying of sand.

- In dry areas, where natural moisture content of sand is low, the bituminous binder shall be fluid cut back conforming the requirements as given in Section 16.4 'Surface Courses and Pavement' under heading '16.4.2 Asphaltic courses'.
- Bitumen emulsion or foamed penetration grade bitumen can also be used subject to the approval of Engineer after trial test.
- Bitumen sand mixture for the grade of bitumen selected shall be ascertained by trial mixes using Marshall Test to determine the quantity of bitumen required, using either heated or unheated sand. The quantity of bitumen required would generally lie between 3 to 6% by weight of dry sand, the higher proportions being required with fine-grained materials.

16.2.5.3 Construction Requirement

- Equipment's, tools and machines used for bitumen stabilized subgrade shall be subject to the approval of Engineer and shall be maintained, in satisfactory working conditions all the times.
- Mix in place method of bitumen stabilization would be subject to the approval of Engineer to ensure full control of bitumen content, uniform and thorough mixing and satisfactory processing of the material to the full depth of the layer. For scarification of in situ material and spreading of Bituminous material, grader with blade and bitumen distributor shall be used.
- The stabilized soil shall be left incompact after pulverization and mixing to allow for evaporation of volatile materials thus increasing stability and decreasing water absorption particularly in fine grained sand when temperature is low.

16.2.5.3.1 Compaction Requirement

- Immediately after completion of mudding, aeration and shaping operation, the mixture shall be thoroughly compacted with rubber or pneumatic-type roller. Compaction shall continue until entire width and depth of subgrade is uniformly compacted to give soaked (96-hours) unconfined compressive strength according to design requirement to meet traffic loading. Steel wheeled tandem roller shall be used to carry out final rolling of compacted surface to eliminate the tire marks.
- To determine the efficiency of mixing, spreading, degree of compaction of equipment and suitability of construction method, trial sections as directed by the Engineer, shall be prepared by the Contractor before main work of stabilization is started.
- If thickness or compacted layer is less than 20cm, it shall be laid as single operation where as if thickness of compacted stabilized layer is more than 20cm, material shall be placed in two or more layers, each within the range of 8-20cm in compacted thickness.
- The results of CBR test for measuring the strength of bitumen stabilized materials or cone stability test for designing bitumen-sand mixture shall not supersede those of Marshall Test unless agreed by the Engineer. In-situ density of compacted layer shall be determined using method as described by AASHTO T-391, AASHTO T-205, or AASHTO T-238 and shall be minimum 95% modified AASHTO according to the above-mentioned methods.
- Frequency of testing in field and in laboratory would be according to relevant schedule for sampling and testing of these Specifications.

16.2.5.3.2 Tolerance

Compacted layer shall comply with tolerance requirements as specified in relevant, "Table for Allowable Tolerances" in these Specifications.

16.2.5.3.3 Weather Limitation

The laying of bituminous courses shall be avoided as far as practicable during wet weather and shall be suspended when free standing water is present on the surface. The stabilized material shall not be laid on any surface, which is frozen or covered with ice or snow, and laying shall cease when the atmospheric temperature reaches 5°C on a falling thermometer. Laying shall not commence until the air temperature is at least 5°C on a rising thermometer unless otherwise directed by the Engineer and also if wet weather threatens to be prolonged, the manufacture and laying of stabilized mix shall be suspended.

16.2.5.4 Measurement and Payment**16.2.5.4.1 Measurement**

The unit of measurement for payment shall be the cubic meter of a given thickness of compacted and accepted subgrade as measure in place. Measurement shall not include any area in excess of that shown on line drawings, except the areas authorized by the Engineer in writing. Measurement of lime consumed shall be the number of metric tons used to stabilize subgrade. This quantity of bitumen consumed shall not exceed the theoretical percentage established in the laboratory.

16.2.5.4.2 Payment

Measured quantity of stabilized subgrade determined as above shall be paid for at the contract unit price per cubic meter or 100 cft. for a particular item listing below and shown on the bill of quantities, which payment shall be full compensation for furnishing all labour, material, tool, plant, equipment; handling, mixing, manipulating, placing, shaping, compacting including necessary water for compaction, rolling, finishing; correcting unsuitable areas and unsatisfactory material; maintenance including protection of stabilized subgrade layer and incidentals necessary for completion of work except bitumen consumed which shall be paid separately as measured above.

Pay item Number	Description	Unit
16.2.5.4.2.1	Bitumen Stabilized Subgrade	CM or 100 cft.
16.2.5.4.2.2	Bitumen Binder, Type	Metric Ton

16.2.6 Dressing and Compaction of Berms**16.2.6.1 Description**

This work shall consist of scarification of berms, which are undulated, or out of level. The exiting material shall be scarified, watered, mixed and properly leveled and compacted according to Specifications described here under or as directed by the Engineer.

16.2.6.2 Material Requirement

In this item, no fresh material is required. However, if fresh material is used, it shall be measured and paid under other relative items of work.

16.2.6.3 Construction Requirement**16.2.6.3.1 Dressing of Berm without use of Extra Material**

In case the berms show undulation of more than 5 cm in level from the reconstructed pavement structure, the berms shall be scarified to a depth of 15 cm and material would be watered, mixed and compact with appropriate equipment approved by the Engineer.

16.2.6.3.2 Dressing of Berm with use of Extra Material

In case the difference of elevation of existing berm with respect to reconstructed road structure is less than 15 cm than additional material (to be measured under other items of work) shall be added to bring the level of berms in conformity with the lines and grades of the existing road. Existing and fresh material shall be properly mixed, watered and compacted as directed by the Engineer.

16.2.6.3.3 Compaction Requirement

Compaction requirement of the fresh and existing material shall be in accordance with the type of material used in berms, as under: -

- Depth in cm Compaction requirement as per AASHTO 1-180 (D)
- 0-15 (Top layer) 95 % for common earth material
- 0-15 (Top layer) 100 % for subgrade material

1. Compaction of Slopes

While reinstating/dressing of beams, it shall be ensured that compaction requirements are observed on slopes of the beams. The degree of compaction shall be as per direction of the Engineer.

16.2.6.4 Measurement and Payment

16.2.6.4.1 Measurement

- Measurement under this item shall be made in square meter of berms dressed or compacted in accordance with the theoretical lines, or sections shown on the drawings; or as per existing edge of road.
- In case partial fresh material is used to compensate for shortage of material in the top layer, the quantity of such material shall be measured by survey levels of existing ground and designed lines, grades or sections shown on the drawing.
- The quantity of material thus measured shall be paid under other items of works of formation of embankment/subgrade.

16.2.6.4.2 Payment

The payment of this item shall be made for at the contract unit price per square meter of dressed and compacted berm measured as above, for scarification watering, mixing, rolling, labor, equipment, tools and incidentals necessary to complete this item.

Pay item Number	Description	Unit
16.2.6.4.2.1	Dressing of berms without extra material	SM or 100 sft.
16.2.6.4.2.2	Dressing of berms with extra material	CM or 100 sft.

16.2.7 Reinstatement of Shoulders from Brick Kiln

This work shall consist of furnishing and placing in single layer of Brick Kiln material on shoulders and to mechanically interlock by watering and rolling, in conformity with lines, grades and cross-sections shown on drawing.

16.2.7.1 Material Requirement

The material shall conform following requirements.

16.2.7.1.1 Texture

The Kiln material shall be fully burnt having reddish brown/black colour. No un-burnt or semi burnt material shall be allowed. The material shall behave like improved subgrade with following properties.

16.2.7.1.2 Gradation

The grading shall conform to the following limits: -

Sieve Designation	Mass Percent Passing
1" (25 mm)	100
$\frac{3}{8}$ " (9.5 mm)	80 – 100
No. 10	50 – 85
No. 200	15 – 35

Table 1, Gradation

Note: Coarser than 1" (25 mm) size material may be allowed up to 5% by the Engineer.

16.2.7.1.3 Physical Requirement

The additional physical requirements of the kiln material would satisfy the following limits: -

- P.I value 6.0% max.
- Swelling value 0.2% max.
- Soaked C.B.R. (96 hours) 20% min.

16.2.7.2 Construction Requirement

- Material for shoulders, obtained and approved as provided above shall be placed and thoroughly mixed with water in horizontal layer of uniform thickness and in conformity with the lines, grades, sections, and dimensions shown on the Drawings. The layer of loose material shall not be more than 20cm in thickness unless otherwise approved by the Engineer.
- The compaction of the shoulders shall be carried out at the designated moisture content, consistent with the improved compacting equipment. Shoulder material that does not contain sufficient moisture to obtain the required compaction shall be given additional moisture by means of approved sprinklers and mixing operations. Material containing moisture more than necessary to obtain the required compaction may not, without written approval of the Engineer be incorporated in the shoulders until it has been sufficiently dried out. The drying of wet material may be expedited by disc method or other approved methods.

- Side slopes shall be neatly trimmed to the lines and slopes shown on the drawings or as directed by the Engineer, and the finished work shall be kept in a neat and acceptable condition.

16.2.7.2.1 Compaction Requirement

All material shall be compacted to a minimum 95% of the maximum dry density as determined according to AASHTO T-180 method 'B' or 'D' whichever is applicable. In place density determination of the compacted layer shall be made in accordance with AASHTO T-180 or other approved method.

16.2.7.3 Measurement and Payment

16.2.7.3.1 Measurement

The quantities to be paid for shall be the number in cubic meter by the theoretical volume of shoulders constructed according to designed lines and grades compacted in place in all respect.

16.2.7.3.2 Payment

The accepted quantities measured as provided above shall be paid for the contract unit price per cubic meter of Brick Kilns shoulder material for the pay item listed below and shown in the Bill of quantities which price and payment shall constitute full compensation for furnishing all materials, hauling mixing, placing watering and compacting labour equipment and incidentals tools necessary to complete the item.

Pay item Number	Description	Unit
16.2.7.3.2.1	Reinstatement of Shoulders from Brick Kiln Material.	CM

16.2.8 Overhaul of Excavation

16.2.8.1 Description

Overhaul shall consist of necessary hauling of excavated material a distance beyond that defined herein as the free haul distance. Unless otherwise shown on the Plans overhaul shall apply only to borrow material; and for these materials, only when called for on the Plans or as provided hereinafter. As far as practicable all the excavated material shall be disposed of, as directed by the Engineer, within the free haul limits.

16.2.8.2 Free Haul

1. When Bid Schedule Shows an Item for Overhaul

When the Bid Schedule shows as item and approximate quantity for Overhaul, the free haul distance shall be 3,000 feet, provided that when the Plans indicate the bid item to be applicable only to a certain class of excavation, all hauling of other classes of excavation shall be considered as free haul, subject should material on which overhaul is to be allowed be obtained from substitute pits furnished by the Contractor, any increase in length of the haul due to such change also shall be considered free haul and any decrease in length of haul shall not reduce the specified free haul distance.

2. When Bid Schedule Does Not Show an Item for Overhaul

When Bid Schedule does not show an item and approximate quantity for Overhaul, all hauling shall be considered as free haul except as follows: -

- When the location of a proposed borrow material pit is changed by the Engineer from that shown on the original plans, and such change entails the hauling of material a distance greater than the length of haul indicated on the original plans, the haul distance indicated on the original plans for such material shall be considered as the free haul distance and the necessary hauling of such material beyond this free haul distance shall be classed as overhaul.
- The Engineer may direct the Contractor to use selected material occurring within the right of way or in borrow pits within the free haul distance to be placed to form the top 1 to 2 ft. of the embankment. The cost of this will be considered as covered under Making / Formation of Embankment.

16.2.8.3 Measurements and Payments

1. Measurement

The quantity of Overhaul to be paid for shall be determined by the mass diagram method. The pay quantity shall be computed as the product of the remaining number of 1000 cubic feet of material from any excavated area after proper deduction has been made for material placed within the free haul limits, multiplied by the distance (unit of one-half KM) such material is hauled in excess of the free haul distance. The distance such material is hauled will be taken as the distance between the center of volume of such remaining excavation and the center of volume of the corresponding embankment. The distance between centers of volume shall be measured along the centerline of construction except in the case of borrow, when it shall be measured along the shortest practical line of haul, as determined by the Engineer.

2. Payment

When the Bid Schedule shows as item and approximate quantity for overhaul, the quantity, determined as provided in 16.2.8.3 and under the conditions of 16.2.8.2 (1), shall be paid for at the unit price per half-KM for carriage of 1000 cft., as established by the Contractor's bid, which price shall be full compensation for complying with the provisions of this Section and includes cost of all labour, machinery, tools etc. When overhaul is encountered under the conditions set forth in 16.2.8.2 (1), and such overhaul is not covered by a bid item, the quantity of such overhaul, determined as provided above, shall be paid for at the rate agreed upon in the contract. One half KM 100 cft. or (one Cubic Meter) Shall equal 100 cubic feet or one cubic meter of excavated material hauled one half KM in excess of the free haul distance. Payment shall be made under: -

Pay item Number	Description	Unit
16.2.8.3.2.1	Overhaul when the bid schedule shows an item for overhaul	Cub meter or 100 cft.
16.2.8.3.2.1	Overhaul when the bid schedule does not show an item for overhaul	Carriage of one cub meter or 100 cft. earth per half KM

16.2.9 Cable Ducts

16.2.9.1 Description

The scope of work shall include the construction of 100 mm cable ducts in accordance with these specifications, the Drawings, and Special Provisions, at locations as provided or as directed by the Consultant.

16.2.9.2 Material Requirements

1. Ducts

Ducts shall be 100 mm nominal inside diameter and of rigid non-metallic P.V.C. pipe. Couplings are to suit the pipe.

2. Spacers

Spacers shall be cast concrete or interlocking plastic designed for 100 mm standard duct on 200 mm by 200 mm centers. The use of wooden or metal spacers will not be permitted.

3. Concrete

All materials for the manufacture of concrete shall be supplied by the Contractor and shall comply with requirements specified in Specification 5.5, Supply of Portland Cement Concrete. Concrete shall have a minimum compressive strength of 20 MPa at 28 days. Aggregate shall have a maximum size of 19 mm. Cement shall be Type HS (Sulphate Resistant) Portland Cement. Slump shall not exceed 80 mm. An air-entrainment agent shall be added to result in an air content between 5 and 7 percent.

4. Rope

Pull rope shall be 7 mm diameter nylon cord. The rope shall be continuous through each duct with 3 meters spare at each end.

5. Sealant

Duct seal shall be a non-thermoplastic compound used for electrical applications. Acceptable compounds are shown on the Alberta Transportation Products List.

16.2.9.3 Construction Requirements

1. Trenching

The trench shall be carefully excavated to the required depth to allow the duct run to be set on undisturbed soil. Where soft spots or unsuitable material are encountered the Contractor shall, at no extra cost, undercut a minimum of 150 mm, or as directed by the Consultant, replace with acceptable material and compacted to 95 % Standard Proctor Maximum Dry Density.

2. Duct Installation

- The duct shall not be placed until the trench has been checked for line and grade by the Consultant. All ducts shall be placed a minimum of 600 mm below subgrade. Duct runs shall be graded uniformly to their ends.

- Duct installation shall be by the tier method using the specified spacers. The duct group shall be securely banded together using metal strapping.
- Duct couplings shall be staggered by at least 150 mm along the duct run. The cutting and tapering of duct joints shall be made with tools as specified by the duct Manufacturer. All duct joints shall be made water tight. Where ducts are to be connected to existing conduits a suitable conduit to duct coupling shall be used. All ducts shall terminate with a duct coupling that is set flush with the end of the concrete envelope.
- Split duct shall be wrapped with a waterproof, impregnated paper or plastic sheeting and securely taped to prevent entry of any concrete.
- The duct assembly shall be securely anchored to the trench bottom to prevent ducts from shifting or floating when concrete is poured.
- The concrete shall be carefully placed by chute down on the sides of the duct bank so that the concrete flows under the ducts and rises up around the ducts to fill all spaces. The concrete shall be carefully rodded with a flat bar.
- Pull ropes shall be installed in each duct and shall be checked to ensure they are free of kinks, bends or joints. The surplus shall be coiled 3 m at each end on the duct.
- Duct locations shall be marked by the Consultant in the field prior to backfilling. A 50 mm by 100 mm marker (painted red) shall extend from the duct entrance to 450 mm above grade.
- A spike shall be driven flush in the edge of the pavement over the duct run.

3. Backfilling and Compaction

Backfilling shall not be undertaken until the concrete and ducts have been checked by the Consultant. The backfill of trenching shall be with material similar to that removed except that organic material or stones larger than 150 mm in diameter shall be removed.

The degree of compacting shall be similar to existing or to the degree required for various pavement layers under other sections of these specifications. The ends of each duct system shall be backfilled using an envelope of sand, or other suitable backfill, extending 1 m from the duct for a width of 600 mm and from the bottom of the duct system to 500 mm above the top duct.

16.2.9.4 Measurement and Payment

1. Cable Duct

Payment will be made at the unit price bid per meter of encasement (including 2-100 mm standard ducts). This price shall include all labour, materials, and equipment necessary to complete the Work to the satisfaction of the Consultant.

16.3 Sub-Base and Base

16.3.1 Granular Sub-Base (Sub-base Course Mechanically Stabilized Soil Aggregate)

16.3.1.1 Description

This item shall consist of furnishing, spreading in one or more layers and compacting granular sub-base according to the Specifications and drawings and/or as directed by the Engineer.

16.3.1.2 Material Requirements

Granular sub-base material shall consist of natural or processed aggregates such as gravel, sand or stone fragment and shall be clean and free from dirt, organic matter and other deleterious substances, and shall be of such nature that it can be compacted readily under watering and rolling to form a firm, stable sub-base. The material shall comply to the following grading and quality requirements: -

- The sub-base material shall have a gradation curve within the limits for grading A, B and C given below. However grading A may be allowed by the Engineer in special circumstances.
- The Coefficient of Uniformity D60/D10 shall be not less than 3, where D60 and D10 are the particle diameters corresponding to 60% and 10%, respectively, passing (by weight) in a grain size analysis, curve.
- The material shall have a CBR value oral least 50%, determined according to AASHTO T-193. The CBR value shall be obtained at a density corresponding to 98% of the maximum dry density determined according to AASHTO T-180 Method-D.
- The course aggregate material retained on sieve No. 4 shall have a percentage of water by the Los Angeles Abrasion (AASHTO T-96) of not more than 50%.
- In order to avoid intrusion of silty and clayey material from the subgrade in the sub-base, the ratio D15 (Sub-base)/D85 (Subgrade) shall be less than 5.
- Where D85 and D15 are the particle diameters corresponding to 85% and 15%, respectively, passing (by weight) in a grain size analysis, curve.
- The fraction passing the 0.075 mm (No. 200) sieve shall not be greater than 2/3rd. of the fraction passing the 0.425 mm (No. 40) sieve. The fraction passing the 0.425 mm sieve shall have a liquid limit of not greater than 25 and a plasticity index of 6 or less.
- If over-size is encountered, screening of material at source, shall invariably be done, no, hand picking shall be allowed, however hand picking may be allowed by the Engineer, if over-size quantity is less than 5% of the total mass.
- Sand equivalent for all classes shall be 25 min.

Grading Requirements for Sub-base Material			
Sieve Designation		Mass Percent Passing Grading	
mm	inch	A	B
60	2-½	100	-----
50	2	90 – 100	100
25	1	50 – 80	55 – 85
9.5	¾	-----	40 – 70
4.75	No. 4	35 – 70	30 – 60
2	No. 10	-----	20 – 50
0.425	No. 40	-----	10 – 30
0.075	No. 200	2 – 8	5 – 15

Table 2, Grading Requirement for Sub-base Material

16.3.1.3 Construction Requirements

16.3.1.3.1 Spreading

- Granular sub-base shall be spread on approved subgrade layer as a uniform mixture. Segregation shall be avoided during spreading and the final compacted layer shall be free from concentration of coarse or fine materials.
- Granular sub-base shall be deposited on the roadbed or shoulders in a quantity which would provide the required compacted thickness without resorting to stopping, picking up or otherwise shifting the sub-base material. In case any material is to be added to compensate for levels, the same shall be done after scarifying the existing material, to ensure proper bonding of additional material.
- When the required thickness is 15cm or less, the aggregates may be spread and compacted as one layer, but in no case shall a layer be less than 7.5cm thick. Where the required thickness is more than 15cm, the aggregate shall be spread and compacted in 2 or more layers of approximately equal thickness, but in any case, the maximum compacted thickness of one layer shall not exceed 15cm. All subsequent layers shall be spread and compacted in a similar manner.
- Granular sub-base shall be spread with equipment that would provide a uniform layer conforming to the specified item both transversely and longitudinally within the tolerances as specified in "Table for Allowable Tolerances" in these Specifications. No hauling or placement of material would be permitted when, in the judgment of the Engineer, the weather or road conditions are such that the hauling operation would cause cutting or rutting of subgrade or contamination of sub base material.

16.3.1.3.2 Compaction Trials

Prior to commencement of granular sub-base operation, Contractor shall construct a trial length; not to exceed, 500m and not less than 200m with the approved sub-base material as would be used during construction to determine the adequacy of the Contractor's equipment, loose depth measurement necessary to result in the specified compacted layer depths, the field moisture content, and the relationship between, the number of compactions passes and the resulting density of the material.

16.3.1.3.3 Compaction

- The moisture content of sub-base material shall be adjusted prior to compaction, by watering with approved sprinklers mounted on trucks or by drying out, as required in order to obtain the specified compaction.
- The sub-base material shall be compacted by means of approved vibrating rollers or steel wheel rollers (rubber tiered rollers may be used as a supplement), progressing gradually from the outside towards the centre, except on super elevated curves, where the rolling shall begin at the low side and progress to the high side. Each succeeding pass shall overlap the previous pass by at least $\frac{1}{3}$ rd. of the roller width. While the rolling progresses, the entire surface of each layer shall, be properly shaped and dressed with a motor grader, to attain a smooth surface free from ruts or ridges and having proper section and crown. Rolling shall continue until entire thickness of each layer is thoroughly and uniformly compacted to the specified density.
- Any area inaccessible to rolling equipment shall be compacted by means of hand guided rollers, plate compactors or mechanical tampers, where the thickness in loose layer shall not be more than 10cm.
- If the layer of sub-base material or part thereof does not conform to the required finish, the Contractor shall, at his own expense, rework, water, and re-compact the material before succeeding layer of the pavement structure is constructed.

- Immediately prior to the placing of first layer of base course the sub-base layer (both under the traveled way and the shoulders) shall conform to the required level and shape. Prior to placing the succeeding layers of the material, the top surface of each layer shall be made sufficiently moist to ensure bond between the layers. The edges or edge slopes shall be bladed or otherwise dressed to conform to the lines and dimensions shown on the plans.
- No material for construction of the base shall be placed until the sub base has been approved by Engineer.

16.3.1.3.4 Compaction Requirement

Relative compaction of each layer of the compacted sub-base shall not be less than 98% of the maximum dry density determined according to AASHTO T-180 Method-D. The field density shall be determined according to AASHTO T-191 or other approved method. For all materials, the field density thus obtained shall be adjusted to account for oversize particles (retained on 19mm sieve) as directed by the Engineer, also for the adjustment of any material retained on 4.75mm sieve AASHTO Method T-224 shall be used.

16.3.1.3.5 Moisture Content Determination

As it is customary in the project laborites that small samples of materials are places in the ovens for moisture determination for proctor, following precautions are necessary to ensure proper compaction results.

- Same size of sample is placed in oven for moisture determination in case of laboratory density (Proctor) and field density.
- Moisture content for calculation of field density and proctor shall be observed on material passing 4.75mm sieve.

16.3.1.3.6 Tolerance

The sub-base shall be compacted to the desired level and cross slopes as shown on the drawings. The allowable tolerance shall be according to the "Table for Allowable Tolerances" in these Specifications.

16.3.1.4 Measurement and Payment

16.3.1.4.1 Measurement

The, quantity of sub-base to be paid for shall be measured by the theoretical volume in place as on the drawings or as directed and approved for construction by the Engineer, placed and accepted in the completed granular sub-base course. No allowance would be given for materials placed outside the theoretical limits as shown on the cross-sections.

16.3.1.4.2 Payment

The accepted quantities measured as provided above shall be paid for at the contract unit price per cubic meter or per 100 cubic ft. of granular sub-base or Crushed Aggregate Sub-base, for the Pay Item in Bill of Quantities, which price and payment shall constitute full compensation for furnishing all materials, hauling, placing, watering, rolling. labour, equipment's, loots and incidentals necessary to complete the item.

Pay item Number	Description	Unit
16-04-a	Gravel Sub base course of the specified thickness	Per 100 Cft
16-04-b	Crushed Aggregate Sub-Base Course of specified Thickness	Per 100 Cft

16.3.2 Aggregate Base Course

16.3.2.1 Description

This item shall consist of furnishing, spreading and compacting one or more layers of aggregate base on a prepared subgrade, sub-base, or existing road surface, in accordance with the Specifications and the drawings and/or as directed by the Engineer.

16.3.2.2 Material Requirement

- Material for aggregate base course shall consist of crushed hard durable gravel, rock or stone fragments.
- It shall be clean and free from organic matters, lumps of clay and other deleterious substances.
- The material shall be of such a nature that it can be compacted readily under watering and rolling to form a firm, stable base for both flexible and rigid pavements. The aggregate base shall comply with the following grading and quality requirements: -
- The gradation curve of the material shall be smooth and within the envelops limits for Grading A or B given below.

Grading Requirements for Aggregate-base Material			
Sieve Designation		Mass Percent Passing Grading	
mm	inch	A	B
50	2	100	100
25	1	70-95	70-95
9.5	$\frac{3}{8}$	30-65	40 -75
4.75	No. 4	25-55	30 -65
2	No. 10	15-40	20 -50
0.425	No. 40	8-20	12-25
0.075	No. 200	2 – 8	5-10

Table 3, Grading Requirements for Aggregate-base Material

- The material shall be well graded such that the Coefficient of Uniformity D60/D10 shall be greater than 4.
- Crushed aggregate (material retained on sieve No.4) shall consist of material of which at least 90% by weight shall be crushed particles, having a minimum of 2 fractured faces.
- The Coarse aggregate shall have a percentage of water by the Loss Angeles Abrasion test (AASHTO T-96) of not more than 40.
- The material shall have a loss of less than 12%, when subjected to five cycles of the Sodium Sulphate Soundness test according to AASHTO T-104.
- The sand equivalent determined according to AASHTO T-176 shall not be less than 45 and the material shall have a Liquid limit of not more than 25 and a plasticity index of not more than 6 as determined by AASHTO T-89 and T-90.

- The material passing the 19mm sieve shall have a CBR value of minimum 80%, tested according to the AASHTO T-193. The CBR value shall be obtained at the maximum dry density determined according to AASHTO T-180, Method D.
- Laminated material shall not exceed 15% of total volume of Aggregate Base Course.

16.3.2.3 Construction Requirement

16.3.2.3.1 Preparation of Surface for Aggregate base Course

In case crushed aggregate base is to be laid over prepared sub-base course, the sub-base course shall not have loose material or moisture in excess to optimum moisture content. Spreading shall conform in all respects to the requirements specified under in this volume under 16.3.1 'Granular Sub-Base' – under heading 'Construction Requirements'.

16.3.2.3.2 Compaction

Compaction process shall conform in all respects to the requirements specified under this heading in Section 16.3.1 'Granular Sub-Base' of this volume.

16.3.2.3.3 Compaction Requirement

- The relative compaction of each layer of the compacted base shall not be less than 100% to the maximum dry density determined according to AASHTO T-180, Method DESCRIPTION (Modified). The field density shall be determined according to AASHTO 1-191 or other approved method. For all materials, the field density thus obtained shall be adjusted by the Engineer. Also, for adjustment of any material retained on 4.75 mm sieve, AASHTO T-224 shall be used.
- Completed base course shall be maintained in an acceptable condition at all times until prime coat is applied. When base course is to carry traffic for an indefinite length of time before receiving surfacing, the Contractor shall maintain the surface until final acceptance and shall prevent reveling by wetting, blading, rolling and addition of fines as may be required to keep the base tightly bound and leave a slight excess of material over the entire surface which must be removed and the surface finish restored before application of prime coat.

16.3.2.3.4 Moisture Content Determination

Moisture content determination shall conform in all respects to the requirements specified in 16.3.1.3.5 of this chapter.

16.3.2.3.5 Trial Section

Prior to commencement of aggregate base course operations, a trial section of 200m minimum, but not to exceed 500m shall be prepared by the Contractor using same material and equipment as would be used at site to determine the adequacy of equipment, loose depth measurement necessary to result in the specified compacted layer depths, field moisture content, and relationship between the number of compactions passes and the resulting density of material.

16.3.2.3.6 Tolerance

The completed base course shall be tested for required thickness and smoothness before acceptance. Any area having waves, irregularities in excess of 1cm in 3M or 2cm in 15M shall be corrected by scarifying the surface, adding approved material, reshaping, re-compacting and finishing as specified. Skin patching of an area without scarifying the surface to permit proper bonding of added material shall not be permitted. The allowable tolerances shall be according to the "Table for Allowable Tolerances" in these Specifications.

16.3.2.3.7 Acceptance, Sampling and Testing

Acceptance of sampling and testing with respect to materials and construction requirements shall be governed by the relevant, "Table for Sampling and Testing Frequency" or as approved by the Engineer.

16.3.2.4 Measurement and Payment

16.3.2.4.1 Measurement

The quantity of aggregate base to be paid for, shall be measured by the theoretical volume in place as on the drawings or as directed and approved for construction by the Engineer, placed and accepted in the completed crushed aggregate base course. No allowance would be given for materials placed outside the theoretical limits as shown on the cross-sections.

16.3.2.4.2 Payment

The accepted quantities measured as provided above shall be paid for at the contract unit price per cubic meter of aggregate base, for the Pay Item in Bill of Quantities, which price and payment shall constitute full compensation for furnishing all materials, hauling, placing, watering, rolling, labour, equipment's, tools and incidentals necessary to complete the item.

Pay item Number	Description	Unit
16.05. a	Aggregate Base Course	CM or 100 cub. ft

16.3.3 Asphaltic Base Course Plant Mix

16.3.3.1 Description

This work shall consist of furnishing of plant, labour, equipment and material and performing all operations in connection with the construction of an Asphaltic plant-mix base course on a previously constructed and accepted subgrade, sub-base or base course, subject to terms and conditions of the Contract, and in strict accordance with this Section of the Specifications, the Drawings and the directions of the Engineer.

16.3.3.2 Material Requirement

16.3.3.2.1 Mineral Aggregate

Mineral aggregate for bituminous base course shall consist of coarse aggregate, fine aggregate and filler material, if required, all conforming with the following requirements: -

- Coarse aggregate which is the material retained on AASHTO No. 4 sieve shall consist of crushed rock, crushed gravel or crushed boulder. It shall be clean, hard, tough, sound, durable, free from decomposed stones, organic matter, shale, clay lump or other deleterious substances. Rock or boulders from which coarse aggregate is obtained, shall be of uniform quality throughout the quarry.
- The crushing shall be so regulated that at least ninety-five (95) percent by weight of material retained on AASHTO No. 4 sieve shall consist of pieces with at least two (2) mechanically fractured faces, and when tested for stability of bituminous mix shall show satisfactory stability.
- Fine aggregate which is material passing No. 4 sieve, shall consist of 100% crushed material from rock or boulder. No natural sand will be allowed in the mix.
- When the combined grading of the coarse and fine aggregates is deficient in material passing No. 200 sieve, additional filler material shall be added. The filler material shall consist of finely divided rock dust, hydrated lime, hydraulic cement or other suitable mineral matter. However, in case the coarse aggregates are of quarzitic nature, then hydrated lime or a better material shall be allowed. At the time of use, it shall be sufficiently dry to flow freely. Filler material shall conform to following gradation: -

US Standard Sieve	Percent Passing by Weight
No. 30	100
No. 50	95-100
No. 200	70-100

Table 4, Gradation

The coarse and fine aggregates shall meet the following applicable requirements: -

- The percentage of wear by the Los Angeles Abrasion test (AASHTO T 96) shall not be more than forty (40).
- The loss when subject to five cycles of the Sodium Sulphate Soundness test (AASHTO T 104) shall be less than twelve (12) percent.
- The Sand Equivalent (AASHTO T 176) determined after all processing except for addition of asphalt cement shall not be less than forty-five (45).
- Fine aggregates shall have a liquid limit not more than twenty-five (25) and a Plasticity Index of not more than six (6) as determined by AASHTO T 89 and T-90.
- The portion of aggregate retained on the 9.5 mm (3/8 inch) sieve shall not contain more than 15 percent by weight of flat and/or elongated particles (ratio of maximum to minimum dimensions = 2.5:1).
- Stripping test shall be performed on coarse aggregates as described under AASHTO T-182 and only that material shall be allowed which qualifies the test.
- The coarse aggregates shall be checked if desired by the Engineer for cationic and anionic behavior so that their affinity with the bitumen to be used is verified.
- Petrographic examination of the coarse aggregate shall be conducted if so, directed by the Engineer.

16.3.3.2.2 Asphaltic Material

Asphalt binder to be mixed with the aggregate to produce asphaltic base shall be asphalt cement having penetration grade 40-50, 60-70 or 80-100 as specified by the Engineer. Generally, it will meet the requirements of AASHTO M - 20.

16.3.3.2.3 Asphalt Concrete Base Course Mixture

The composition of the asphaltic concrete paving mixtures for base course shall conform to Class A and/or Class B shown in the following table: -

Mix Design	Class A	Class B
Use	Leveling/ Base	Leveling/ Base
Compacted Thickness	70-90 mm	50-80 mm
U.S Standard Sieve Size Percent passing by Weight		
2" (50 mm)	100	--
1 1/2" (38 mm)	90-100	100
1" (25 mm)	--	75-90
3/4" (19 mm)	56-75	65-80
1/2" (12.5 mm)	--	55-70
3/8" (9.5 mm)	--	45-60
No. 4 (4.75 mm)	23-40	30-45
No. 8 (2.38 mm)	15-30	15-35
No. 50 (0.300 mm)	4-10	5-15
No. 200 (0.075 mm)	3-6	2-7
Asphalt Content weight percent of total mix	3 (Minimum)	3 (Minimum)

Table 5, Combined Aggregate Grading Requirements

The asphalt concrete leveling / base course mixture shall meet the following Marshall Test Criteria: -

Compaction, number of blows each end of specimen	75
Stability	1000 Kg (Min.)
Flow, 0.25 mm (0.01 in.)	8-14
Percent air voids in mix	4-8
Percent voids in mineral aggregate	According to Table 5.3 MS-2, Asphalt institute, sixth edition 1993
Loss in Stability	25 Percent (Max.)

Mixes composed of larger size aggregates with maximum size up to 38 mm (1.5 inches) will be prepared according to modified Marshall method as per MS-2 Asphalt institute, sixth edition, 1993 or the latest edition. The Procedure is basically the same as the original method except for following differences that are due to the larger specimen size that is used: -

- The hammer weighs 10.2 kg (22.5 lb.) and has a 149.4 mm (5.88 inches) flat tamping face. Only mechanically-operated device is used for the same 457 mm (18 inches) drop height.
- The specimen has a 152.4 mm (6 inches) diameter by 95.2 mm (3.75 inches) height.
- The batch weights are typically of 4 Kg.
- The equipment for compacting and testing (molds and breaking heads) are proportionately larger to accommodate the larger specimens.
- The mix is placed in the mold in two approximately equal increments, with spading performed after each increment to avoid honey-combing.
- The number of blows needed for the larger specimen is 1.5 times (75 or 112 blows) of that required for the smaller specimen (50 or 75 blows) to obtain equivalent compaction.
- The design criteria shall be modified as well, the minimum stability shall be 2.25 times and the range of flow values shall be 1.5 times normal-sized specimens.

- Similar to the normal procedure, following values shall be used to convert the measured stability values to an equivalent value for a specimen with a 95.2 mm (3.75 inches) thickness, if the actual thickness varies: -

Approximate Height	Specimen Volume	Correlation Ratio
Mm (Inches)	(Cubic cm)	
88.9 (3 ½)	1608 to 1262	1.12
90.5 (3 9/16)	1637 to 1665	1.09
92.1 (3 5/8)	1666 to 1694	1.06
93.7 (3 11/16)	1695 to 1723	1.03
95.2 (3 ¾)	1724 to 1752	1.00
96.8 (3 13/16)	1753 to 1781	0.97
98.4 (3 7/8)	1782 to 1810	0.95
100 (3 15/16)	1811 to 1839	0.92
101.6 (4)	1840 to 1968	0.90

Table 6, Requirements for a specimen

16.3.3.2.4 Job Mix Formula

At least one week prior to production, a Job-Mix Formula (JMF) for the asphaltic base course to be used for the project, shall be established jointly by the Engineer and the Contractor in the project laboratory. Job mix formula shall combine the mineral aggregates and asphalts in such proportion conforming to specification requirements. The JMF shall be established by MARSHALL Method of Mix Design according to the procedure prescribed in the Asphalt Institute Manual Series No. 2 (MS-2), sixth edition 1993, or the latest Edition. The JMF, with the allowable tolerances shall be within the range specified in Item 16.3.3.2.3 Each JMF shall indicate a single percentage of aggregate passing each required sieve size and a single percentage of bitumen to be added to the aggregate. The ratio of wt. of filler (passing sieve No. 200) to that of asphalt shall range between 1-1.5 for hot climate areas with temperature more than 40°C. After the JMF is established, all mixtures furnished for the project represented by samples taken from the asphalt plant during operation, shall conform thereto Moreover upon receiving the job-mix, approved by the Engineer, the Contractor shall adjust his plant to proportion the individual aggregates, mineral filler and asphalt to produce a final mix that, when compared to job mix formula shall be within the following limits: -

1. Maximum Variation of Percentage of Materials

Retained No. 4 and larger	±7.0 %
Passing No.4 to No. 100 Sieve	±4.0 %
Passing No. 200	±1.0 %

2. Asphalt Content

Weight Percent of total Mix	±0.3 %
-----------------------------	--------

In addition to meeting the requirements specified in the proceeding items, the mixture as established by the JMF shall also satisfy the following physical property Loss of Marshall. stability by immersion of specimen in water at sixty (60) degree centigrade for 24 hours as compared with stability measured after immersion in water at 60 degrees centigrade for 20 minutes shall not exceeds twenty-five (25) percent. If the mixture fails to meet this criterion, JMF shall be modified or an antistripping agent shall be used. Should a change of sources of materials be made, a new Job Mix Formula shall be established before the new material is

used. When unsatisfactory results or other conditions make it necessary, a new Job Mix Formula will be required.

16.3.3.3 Construction Requirement

16.3.3.3.1 Bituminous Mixing Plant

Plants used for the preparation of bituminous mixtures shall be "Batching Plants" conforming to AASHTO M 156, and of adequate capacity, coordinated and operated to produce a mixture within the limits of these Specifications. Plant shall have minimum three cold bins and at least 3.5 decks of hot sieves.

16.3.3.3.2 Preparation of Aggregate

- Before being fed to the dryer, aggregates for the Asphaltic base causes shall be separated into three or more sizes and stored separately in cold bins. One bin shall contain aggregate of such size that 80% would pass sieve No:4, and the other two bins shall contain aggregate of such sizes that 80% would be retained on sieve No. 4. Shall fine material, be incorporated in the mix, separate bin shall be provided in addition to the three bins mentioned above. If filler is used as a separate component it would also be stored and measured separately and accurately before being fed into the mixer through filler screw mechanism.
- Asphalt cement shall be heated within a temperature range of 135-163°C at the time of mixing. Asphalt cement heated above maximum shown shall be considered overheated and shall be rejected and removed from job site.
- Dried aggregate weighed and drawn to pug mill shall be combined, with proportionate quantity of asphalt cement according to the job mix formula. Temperatures of asphalt except for temporary fluctuations, shall not be lower than 15°C below the temperature of the aggregate, at the time; the two materials enter into the pug-mill.
- For placing the materials in bins or in moving them from bins to the dryer, any method which causes segregation or uncontrolled combination of materials of different grading shall be discontinued and the segregated or degraded materials shall be prescreened for reuse.
- Each aggregate ingredient shall be heated and dried at temperature not to exceed 163°C. If aggregate contain sufficient moisture to cause foaming in the mixture or their temperature is in excess of 163°C, they shall be removed from the bins and returned to their respective stock piles. In no case, shall the temperature of Asphaltic mix exceed 163°C when discharged from the pug-mill.
- Immediately after beating, the aggregates shall be screened to required sizes and stored in separate hot bins for batching and mixing with bituminous material.
- Asphalt plant shall have minimum 3½-sieve decks to effectively control the gradation of hot bins.

16.3.3.3.3 Hauling Equipment

- Dump truck used for hauling bituminous mixtures shall have tight, clean, smooth metal beds which have been thinly coated with an approved material to prevent adhering of material to the beds.
- Each truck shall have a cover of canvas or of other suitable material of sufficient size as to protect the mixture from the weather. The mixture would be delivered on the mad

at a temperature not less than 130°C. Drivers of dump trucks would ensure that while reversing the vehicles, paver is not pushed back producing a hump.

16.3.3.3.4 Bituminous Pavers

- Bituminous pavers shall be self-contained, power-propelled units, provided with an automatically controlled activated screed or strike-off assembly, heated if necessary, capable of spreading and finishing courses of bituminous plant mix material in lane widths applicable to the specified typical section and thickness shown on the plans. Pavers used for shoulders and similar construction shall be capable of spreading and finishing course of bituminous plant mix material in widths shown on the plans.
- The paver shall be equipped with a receiving hopper having sufficient capacity for a uniform for a uniform spreading operation. The paver shall be equipped with automatic feed controls, properly adjusted to maintain a uniform depth of material ahead of the screed.
- The screed or strike-off assembly shall be capable of producing a finished surface of the required evenness and texture without tearing, shoving or gouging the mixture.
- When laying the mixtures; the paver shall be capable of being operated at forward speeds consistent with satisfactory laying of the mixture. The paver shall be operated at speeds which would give the best result for the type of power being used.
- The mixed material shall be delivered to paver in time to permit completion of spreading, finishing and compaction of mixture during the day light hours.
- The paver shall be equipped with automatic screed controls with sensors for either or both sides of the paver, capable of sensing grade from an outside reference line, sensing the transverse slope of the screed and providing the automatic signals which operates the screed to maintain the desired grade and transverse slope. The sensor shall be so constructed that it would operate from a reference line or a ski-like arrangement.
- The transverse slope controller shall be capable of maintaining the screed at the desired slope within plus or minus 0.1% variation.
- Manual operation would only be permitted in the construction of irregularly shaped and minor areas.
- Whenever a breakdown or malfunction of the automatic controls occurs, the equipment may be operated manually or by other methods in order to allow the Contractor to use the asphalt already produced at the plant or in transit, provided this method of operation would produce results otherwise meeting the Specifications.
- Reference lines would be required for both outer edges of the traveled way for each main line roadway for vertical control. Horizontal control utilizing the reference line would be permitted. The grade and slope for intermediate lanes shall be controlled automatically from reference lines or by means of a ski and a slope control device or a dual ski arrangement. When the finish of the grade prepared for paving is superior to the established tolerance and, when in the opinion of the Engineer, further improvement to the line, grade, cross-sections and smoothness can best be achieved without the use of the reference line, a ski-like arrangement may be substituted subject to the approval of the Engineer. The use of the reference lines shall be reinstated immediately whenever the Contractor fails to maintain a superior pavement. The Contractor shall furnish and install all pins, brackets, tensioning devices, wire and accessories necessary for satisfactory operation of the automatic control equipment.

16.3.3.3.5 Rollers

Rollers shall be steel wheel, pneumatic tire and vibratory, or a combination thereof. The roller(s) shall be in good condition, capable of reversing without backlash, and be operated at speeds slow enough to avoid displacement of the bituminous mixture. The number and weight of rollers shall be sufficient to compact the mixture to the required density while it is still in a workable condition. Vibratory rollers shall be acceptable for bituminous mixture compaction. The use of equipment, which results in excessive crushing of the aggregate would not be permitted.

16.3.3.3.6 Preparation of Base or Existing Pavement Surface

- Before spreading materials, the surface of base or existing pavement on which the mix is to be placed shall be conditioned by application of a prime or tack coat as specified.
- After a prime coat is applied, it shall be left undisturbed for less than 24 hours. The Contractor shall maintain the primed surface until the mix material has been placed. This maintenance shall include the spreading of sand or other approved material, if necessary, to prevent adherence of the prime coat to the tires of vehicles using the primed surface, and patching any breaks in the primed surface with additional bituminous material. Any area of primed surface that has become damaged shall be repaired before the mix is placed, to the satisfaction of Engineer. It shall be ensured that primed surface is not in tacky condition, when premix is laid.
- After a tack coat is applied, it shall be allowed to dry until it is in the proper condition of tackiness to receive the mix. The tack coat shall be applied only as far in advance of the placing of mix, as is necessary to obtain the proper condition of tackiness. Any breaks in the tack coat shall be repaired.
- When the surface of the existing pavement or old base is irregular, it shall be brought to uniform grade and cross-section by leveling course as directed. The leveling course mixture shall conform to the requirements of material mentioned above.
- A thin coating of bituminous material shall be sprayed on contact surface of curbing, gutters, manholes and other structures, prior to the bituminous mixture being placed against them.

16.3.3.3.7 Spreading and Finishing

- The mixture shall be laid upon an approved surface, spread and struck off to the section and elevation established. Bituminous pavers shall be used to distribute the mixture either over the entire width or over such partial width as maybe practicable.
- The longitudinal joint in one layer shall offset to that in the layer immediately below, by approximately 15cm, however, the joint in the top layer shall be at the centerline of the pavement if the roadway comprises two lanes of width or at lane lines if the roadway is more than 2 lanes in width.
- On areas where irregularities or unavoidable obstacles make the use of mechanical spreading and finishing equipment impracticable, the mixture shall be spread, raked and loaded by hand tools. For such areas the mixture shall be dumped, spread and screened to give the required compacted thickness, ensuring even distribution of coarse and fine material.
- When production of the mixture can be maintained and wherever practical, pavers shall be used in echelon to place the wearing course in adjacent lanes and compacted to form a surface without lateral joint.
- All mixtures shall be spread at a temperature of not less than 130°C and all initial rolling or tamping shall be performed when the temperature of the mixture is such that the sum of the air temperature plus the temperature of the mixture is between 165°C and

190°C. The mixture shall not be placed on any wet surface of when weather conditions would otherwise prevent its proper handling or finishing.

16.3.3.3.8 Compaction

- After spreading and strike off and as soon as the mix condition permits the rolling to be performed without excessive shoving or tearing, the mixture shall be thoroughly and uniformly compacted. Rolling shall not be prolonged when cracks appear on the surface.
- Initial or breakdown rolling shall be done by means of either a tandem steel roller or three wheeled steel rollers. Rolling shall begin as soon as the mixture would bear the roller without undue displacement.
- The number and weight-of rollers shall be sufficient to obtain the required compaction while the mixture is still in workable condition. The sequence of rolling and the selection of roller types shall provide the specified pavement density. Initial rolling with a tandem steel roller or a three-wheeled steel roller shall follow the paver as closely as possible.
- Unless otherwise directed, rolling shall begin at the lower side and process longitudinally, parallel to the road centerline, each trip overlapping one-half of the roller width, gradually progressing to the crown of the road. When paying in echelon or abutting a previously placed lane, the longitudinal joint shall be rolled first followed by the regular rolling procedure. On super elevated curves the rolling shall begin at the low side and progress to the high side by overlapping of longitudinal trips. parallel to the centerline. Intermediate rolling with a pneumatic tired roller shall be done behind the initial rolling. Final rolling shall eliminate marks from previous rolling. In no case shall the temperature be less than 120°C for initial breakdown rolling while all other compaction operations shall be completed before the temperature drips down to 110°C.
- Rollers shall move at a slow but uniform speed with drive roll or wheels nearest the paver. Rolling shall be continued until all roller marks, we eliminated and a minimum density of 97% of a laboratory compacted specimen made from asphaltic material obtained for daily Marshall density is achieved.
- Any displacement resulting while reversing the direction of a roller, or from other causes, shall be corrected at once by the use of rakes and addition of fresh mixture when required. Care shall be exercised in rolling not to displace the line and grade of the edges of the bituminous mixture.
- To prevent adhesion of the mixture to the rollers, wheels of rollers shall be kept properly moistened with water or water mixed with very small quantities of detergent or oilier approved material. Excess liquid would not be permitted.
- Along forms, curbs, headers, walls and other places not accessible to the roller, the mixture shall be thoroughly compacted with hot hand tampers, smoothing irons or with mechanical tampers. On depressed areas, tempers be used or cleated compression strips may be used under the roller to transmit compression to the depressed area.
- Any mixture that becomes loose and broken, mixed with dirt, or is in any way defective in finish or density shall be removed and replaced with fresh hot mixture, which shall be compacted to conform with the surrounding area. Any area showing an excess or deficiency of bituminous material shall be removed and replaced.
- Sequence of laying and compaction of premix shall be so managed, that a long time does not elapse between successive dump trucks, which may cool down the incompact premix paver and compacted asphalt below 120°C.

16.3.3.3.9 Frequency of Testing for Cores

One core shall be taken for each 100m of each lane of Asphaltic Base, or fraction thereof, in special cases. If the core so taken is failed against the specified 97% density, then 2 additional cores shall be taken in the longitudinal alignment of the road at an interval of (3) meters on either side with respect to the failing core and shall be tested against field density. If all the 3 cores give an average of 97% compaction, and the individual compaction is acceptable of the core is not less than 95%, then the compaction is acceptable. If average of the cores further fails against compaction, then retake the cores at a distance of 15m on either side and compaction shall be checked for all the 5 cores in the same fashion. If average of 5 cores is 97%, the area would be accepted. In case average is 96% or more, then Engineer may withhold the payment in full or partly and observe behavior during maintenance period, for the release of payment or otherwise. In case of failure of the average of these 5 cores giving average compaction of less than 96%, the failed area shall be removed and subsequently be replaced by specified mix in an approved manner at the expense of Contractor.

16.3.3.3.10 Surface Tolerance

- After completion of final rolling, the finished surface shall be tested for smoothness with 3m straightedge by Engineer at selected locations. The variation of surface from testing edge of straight edge between any 2 contacts with surface shall at no point exceed 6mm when placed either parallel or perpendicular to centerline of roadway.
- Any irregularities that exceed the specified tolerances or that retain water on the surface shall be corrected by removing the defective area and replacing with new asphaltic base course without additional cost to the Engineer.

16.3.3.3.11 Base Thickness Tolerance

- For determination of thickness, 1 core for each 100m of each lane shall be taken. Unless otherwise permitted, cores extracted for thickness measurement shall not be used for density determination and density cores shall not be used for thickness measurements.
- When layer thickness of asphaltic base course is deficient by more than 5 from that specified in the Drawing; the deficiency shall be removed with satisfactory base course material and/or made up by additional asphalt concrete wearing course thickness without extra cost to the Employer. If such remedial action is authorized, revised thickness determinations shall be made by measurements of new cores taken after placing of "Asphaltic Wearing Course" material or as directed by the Engineer. If base course deficiencies are corrected in this manner, full payment for the "Asphaltic Base Course" would be made to the Contractor, but no additional payment would be made of the increase in thickness of the "Asphaltic Wearing Course".

16.3.3.3.12 Acceptance Sampling and Testing

Acceptance of samples and testing of materials and construction requirements, shall be governed by the relevant, "Table for Sampling and Testing Frequency" or as approved by the Engineer.

16.3.3.3.13 Weather Limitation

Hot asphaltic mixtures shall be placed only when the air temperature is four 4°C or above and no asphalt shall be laid under foggy or rainy weather or over moist surface.

16.3.3.3.14 Trial Section

Contractor shall prepare a trial section before the start of work.

16.3.3.4 Measurement and Payment**16.3.3.4.1 Measurement**

The quantities for asphaltic leveling / base course would be measured by volume in cubic meters compacted in place. Measurement shall be based on the dimension as shown on plan or as otherwise directed or authorized by the Engineer. No measurement shall be made of unauthorized areas or for extra thickness. The quantity of asphaltic material used is included in the asphalt concrete mixture and would not be measured separately. Quantities of liquid asphalt, wasted or remaining on hand after completion of the work shall not be measured or paid for.

16.3.3.4.2 Payment

The quantities determined as provided above shall be paid for at the contract unit price respectively for each of the particular pay items listed below and shown in the Bill of Quantities, which prices and payment shall constitute full compensation for all the costs necessary for the proper completion of the work prescribed in this item. Asphalt additive or antistripping agent, if allowed and used to meet with JMF requirement shall not be paid directly, payment shall be deemed to be included in the respective pay items of Asphaltic Base Course.

Pay item Number	Description	Unit
16.3.3.4.2.1	Asphaltic Base Course- Plant Mix (Class A)	CM
16.3.3.4.2.2	Asphaltic Base Course- Plant Mix (Class B)	CM
16.3.3.4.2.3	Asphaltic Leveling Course- Plant Mix (Class A)	CM
16.3.3.4.2.4	Asphaltic Leveling Course- Plant Mix (Class B)	CM

16.3.4 Soil Cement Stabilized Sub-Base or Base**16.3.4.1 Description**

The work shall consist of performing all operations in connection with the construction of cement stabilized sub-base or base and all incidents in accordance with the Specifications in conformity with the lines, grade, thickness and typical cross-sections shown on the plans or as directed by the Engineer.

16.3.4.2 Material Requirement**16.3.4.2.1 Mineral Aggregate**

- Aggregate shall be clean, tough, hard durable particles free of decomposed stone, organic matter and other deleterious substance and shall consist of material of which at least 50% by weight of the total aggregates shall have at least 2 mechanically fractured faces for cement stabilized sub-base whereas for cement stabilized base

course, material shall have at least 90% by weight of total aggregate having 2 mechanically fractured faces.

- Coarse aggregate retained on No. 4 shall have a percentage of wear by Los Angeles Abrasion as determined by AASHTO T-96 not more than 45 for base course and 50 for sub-base material.
- Fraction Passing 0.075mm (No. 200) shall not be greater than $\frac{2}{3}$ rd. of the fraction passing the 0.425mm (No. 40) sieve. The fraction passing 0.425mm (No. 40) sieve shall have a liquid limit not greater than 25% and plasticity index not greater than 6.
- Sandy and gravely soils used for cement stabilization shall fulfill the following grading requirements.

Passing maximum size 50 mm sieve	100%
Passing AASHTO No. 4 sieve	above 50%
Passing AASHTO No. 40 sieve	above 15%
Passing AASHTO No. 200 sieve	below 5%
Clay fraction, finer than 0.002 mm	below 3%

Table 7, Gradation Requirements

16.3.4.2.2 Cement

Cement shall conform in all respect to requirement under specified item of concrete.

16.3.4.2.3 Water

Water used for cement stabilized base course or sub-base shall conform in all respect to requirements specified under item of concrete.

16.3.4.2.4 Mix Design requirement in Laboratory

Prior to commencement the work of stabilization, proposed mix design indicating the exact percentage of cement and water to be used so as to obtain a uniform mixture, shall be submitted by the Contractor for Engineer's approval, and Shall fulfill the following requirements: -

- The mixture sample submerged in water for 2hours before crushing, after storage in a box having minimum humidity of 95% for 24hours shall have a minimum compressive strength of 23kg/cm² (327 psi) for sub base and 30kg/cm² (427 psi) for base respectively.
- The maximum permissive swelling of volume shall be 2% and maximum loss in weight 8% when tested in accordance with AASHTO T-135.
- Maximum variation during constructions shall be as given below: -

Cement Content: -1 to +1 % of that given in the mix design.
Water Contents: 0 to +2 % of that given in the mix design

- Bituminous material for curing seal shall be any one of the following: -

Type	Applicable Specification
RC-250	AASHTO M-81
MC-250	AASHTO M-82
SS-1	AASHTO M-140

RT-5	AASHTO M-52
------	-------------

Table 8, Applicable Specification

- Optimum moisture content shall be determined in accordance with AASHTO T-134 by placing moist sample under shade for 7-days and crushing after 2-hours of immersion in water.

16.3.4.2.5 Composition of Mixture at site

The granular material shall thoroughly be mixed at site with sufficient cement to obtain required crushing strength. The cement content shall be determined at the laboratory so that minimum compressive strength or mixture is 50kg/cm² for sub base and 80kg/cm² for base respectively at 7-days. The moisture content of the mix cement stabilized material shall not be less than the optimum as determined by AASHTO T-134 Method and not more than 2% above the optimum as determined by this test or such higher value as may be agreed by the Engineer on basis of preliminary trial.

16.3.4.3 Construction Requirements

16.3.4.3.1 Stationary Plant Method

- Equipment's, tools, machines used in the performance of cement stabilized sub-base, base shall be subject to the approval of Engineer and shall be maintained in satisfactory working condition at all times.
- If stationary plant is used, it shall be of the power-driven paddle or pan type and may be of batch or continuous type.
- If batch mixer is used, measured amount of material and cement shall first be placed in mixer, water being added to bring moisture content of mixture within the optimum range. Mixing shall be continued until mixture is uniformly mixed but in no case less than 1-minute time.
- The mixing plant shall be of approved type, coordinated and operated as to produce mixture within mix design requirements and shall be of sufficient capacity.
- The aggregate, cement and water shall be mixed at an approved central mixing plant by either continuous-flow or batch type mixer revolving blades or rotary drum mixer.
- The plant shall be equipped with feeding and metering devices that add the materials; cement and water into the mixer in specified quantities; mixed thoroughly and sufficiently to obtain intimate and uniform mixture without cement lumps.
- The mixture shall be transported to paving area in trucks or other. approved equipment's having clean bed within a maximum hauling time of 45-minutes.
- The mixture shall be placed on moist subgrade/or sub-base without segregation at a rate that would produce a uniformly compacted layer conforming to the required grade and cross-section. The mixture shall be spread by spreader within 30-minutes after placement of mixture.
- Compaction shall start as soon as possible after spreading and elapsed time between the addition of water to mixture and start of compaction shall not exceed 90-minutes.

16.3.4.3.2 Mix in Place Method

- Cement stabilized sub-base/base course can also be constructed by Mix-In-Place method. The plant used for pulverizing and mixing the stabilized material shall be approved by the Engineer on the basis of trial conducted to establish that the plant is

capable of producing the degree of mixing and uniformity of material according to Specifications requirement. The material shall be processed throughout the depth of layer with blades of approved mixing equipment. The cement shall be spread ahead of mixer by means of cement spreader, fitted with a device to ensure uniform and required rate of spread of cement both transversely and longitudinally.

- Moisture content of the material shall be adjusted to optimum using water sprayer of such design that wafer is discharged in uniform and controllable manner both transversely and longitudinally.

16.3.4.3.3 Construction Joints

- In the end of each day construction, a straight transverse construction joint shall be formed by cutting into completed work to form a true vertical face.
- For large area, a series of parallel lanes of convenient length and width meeting approval of Engineer shall be built with true vertical face free of loose or shattered material.
- Guide stakes shall be set for cement spreading and mixing.
- Grade and alignment stakes shall be furnished, set and maintained by Contractor, in order that the work shall conform to the lines, grade and cross-sections shown on the drawing.
- All material shall be placed and spread evenly by mechanical spreader capable of leveling off the material to an even depth. The mixture shall be mixed uniformly with proper moisture content. Areas of segregated material shall be corrected by removing and replacing with satisfactory material or by re-mixing. When necessary to meet the requirements, additional approved material shall be spread in such amounts as are found to be necessary and the added material shall be uniformly mixed into previously placed material, adding water as required to obtain the specified density.

16.3.4.3.4 Compaction

- The thickness of layer shall be as shown; on the Drawings but in no case shall be less than eight (8) centimeters or 3 inches. If thickness of each layer does not exceed twenty centimeters (8 inches), it shall be constructed as one layer. If thickness of layer exceeds twenty (20) cm, (8 inches) it shall be constructed in two or more layers each within the range of eight (8) to twenty (20) cm (3 inch to 8 inch) in compacted thickness.
- The mixture shall be spread and finished true to crown and grade by machine or hand method where machine methods are impracticable as determined by the Engineer and shall be thoroughly compacted with approved rollers until entire depth and width of sub-base/base is uniformly compacted to maximum density of 95 % as tested according to procedure outlined in AASFIT01-134.
- The compaction shall be complete as soon as possible after mixing, normally within three (3) hours after adding water depending on setting lime of cement and the weather conditions.
- Compaction shall not take place after cement hydration and any material that has been mixed or deposited after cement has hydrated shall be removed and replaced with fresh mix material.

16.3.4.3.5 Preliminary Trial

At least 1-week before main work of stabilization is started Contractor shall construct a trial section of 200m in length at location approved by the Engineer with same material, equipment,

mix proportion and construction procedure that he proposes to use for the main work. Purpose of this trial section is to determine efficiency of mixing, spreading, compaction, suitability of construction procedures, depth of layer being compacted with available compactive effort. In place density determination would be made using AASHTO T-191 or AASHTO T-205 & T-238 Method.

16.3.4.3.6 Curing/Maintenance

- After compaction the stabilized sub-base/base layer shall be protected against drying out by, keeping it continuously damp for a period of at least 3-days or by coating with approved curing material at the rate approved by the Engineer.
- The completed cement stabilized sub-base/base shall be maintained in an acceptable condition at all the times, prior to construction of subsequent asphaltic layer.
- No vehicular traffic shall be allowed to pass on the compacted layer until curing period has elapsed with a minimum no-traffic period of 7-days.
- Cement stabilized sub-base/base shall be constructed only when the atmospheric temperature is above 40C and when the weather is not rainy.

16.3.4.3.7 Tolerance

The surface of each subbase/base course shall be properly shaped to a smooth uniform surface parallel to the finished surface of the carriageway and shall not vary more than the limits as specified in the relevant, "Table for Allowable Tolerances" in these specifications. The completed Subbase/Base course shall be tested for required thickness and surface before acceptance. Any area having compacted thickness less than the thickness shown in the bill of quantities and/or on the drawings shall be rectified by scarifying the top seventy-five (75) mm, reshaping with added material and recompacting all to specification. Skin patching of an area without scarifying the surface to permit, proper bonding of added material will not be permitted.

16.3.4.4 Measurements and Payments

16.3.4.4.1 Measurements

- The unit of measurement for payment shall be cubic meter of the compacted and accepted sub-base/base material as measured in place. Measurement shall not include any areas in excess of that shown on the drawings except the areas authorized in writing, by the Engineer.
- Measurement of cement content used shall be the number of metric Ton consumed to stabilize sub-base/base. This quantity of cement used shall not exceed the theoretical percentage established in the laboratory.
- Bituminous curing material shall be measured by the metric Ton. The Contractor shall furnish in duplicate certified weight tickets from the batch scales of commercial plants.

16.3.4.4.2 Payments

Measured quantity of stabilized sub-base/base determined as provided above shall be paid for at the contract unit price per cubic meter for a particular item listed below and shown on the BOQs, which payment shall be full compensation for furnishing all labour, material, tool, plant, equipment, handling, mixing, manipulating, placing, shaping, compacting including necessary water for compaction, rolling, finishing; correcting unsuitable area and unsatisfactory material; maintenance including protection of stabilized sub-base/base layer

and incidentals necessary for completion of work except cement consumed which shall be paid separately as measured above. Payment for bituminous material shall include labour, material, heating (if required) equipment, spreading and protection from traffic as directed by the Engineer.

Pay item Number	Description	Unit
16-49	Cement Stabilized Subbase	m ³ or 100 cft
16-52	Cement Stabilized Base	m ³ or 100 cft
16.3.4.4.2	Cement content	Metric Ton
16.3.4.4.2	Rapid Curing Cut Back Asphalt	Metric Ton
16.3.4.4.2	Medium Curing Cut Back Asphalt	Metric Ton
16.3.4.4.2	Emulsified Asphalt for curing seal	Metric Ton

16.3.5 Crack Relief Layer

16.3.5.1 Description

The work shall consist of constructing a layer of graded crushed aggregate or asphaltic open-graded plant mix on a prepared soil-cement base course in accordance with these Specifications and in conformity with the lines, grades, thicknesses and typical cross-sections shown on the Drawings.

16.3.5.2 Material Requirement

16.3.5.2.1 Aggregates

1. Material for a layer of graded crushed aggregate

Material for graded crushed aggregates shall in all respects conform with the requirements specified and with the following exceptions and supplementary requirements: -

- The portion of the aggregate retained on the 9.5 mm. (3/8 inch) sieve shall not contain more than 10 percent by weight of flat and/or elongated particles (ratio of maximum to minimum dimension =2.5:1).
- Crushed aggregates shall consist of particles with not less than Ninety (90) percent of the portion retained on the 4.75 mm. (No. 4) sieve having at least two fractured faces.

2. Material for a layer of asphaltic open graded plant mix

Aggregates for the asphaltic open-graded plant mix shall conform to the requirements of Clause 16.3.3.2.1 of Section Asphaltic Base-course with the following exceptions: -

- Fine aggregates and mineral filler will be required.
- Sand equivalent and plasticity requirements are not applicable.

16.3.5.2.2 Asphaltic Material

Asphaltic binder shall be asphaltic cement, 60-70 penetration grade, meeting the requirements of AASHTO M-20.

16.3.5.2.3 Asphaltic Open Graded Mixture

The composition of the asphaltic open-graded crack-relief layer shall meet the following criteria: -

Aggregate Grading Requirements		
Sieve Designation		Percent Passing by Weight
mm	Inch	
50	2	100
37.5	1 ½	75-90
19	¾	50-70
4.75	No. 4	8-20
0.15	No. 100	0-5
Asphalt Cement Content of total Mix		2-3% by Weight
Mixing Time		30 seconds (Maximum)
Mix Design		Within Master Range Gradation

Table 9, Aggregate Grading Requirements

The exact percentage of asphalt cement content shall be such that at least Ninety-five (95) percent coating of aggregates will be achieved when tested in accordance with AASHTO T-195.

16.3.5.3 Construction Requirements

16.3.5.3.1 Graded Crushed Aggregate

Construction of this layer shall conform in all respects to the requirements of specified item.

16.3.5.3.2 Asphaltic Open-Graded Crack Relief Layer

Construction of this layer shall conform in all respects to the requirements specified in item, except as provided below: -

- Compaction shall be accomplished by 10-Ton Steel wheeled tandem rollers. A maximum of three complete coverages, or as otherwise directed by the Engineer, shall be sufficient. No density test would be required; however, the compaction shall be achieved in the same manner as displayed in the total test and to satisfaction of the Engineer.
- The consistency and temperature of the mix shall be such controlled that it does not squeeze out or move under the pressure of compacting roller. For this purpose, trial reaches shall be prepared by the Contractor to fix the above Parameters. In order to ensure the stability of CRL before the placement of any subsequent layer or opening of a layer to traffic, a priming time of 4-days in hot weather would be allowed. This time may be reduced to 2-days where the lower temperature allows.
- All traffic shall be kept off this layer until a subsequent layer has been placed on it. Any damage caused by traffic moving directly on the crack-relief layer shall be the responsibility of the Contractor and all necessary repair work thereto shall be at the Contractor's expense.

16.3.5.4 Measurements and Payments

16.3.5.4.1 Measurements

- The quantities of graded crushed aggregated crack-relief asphaltic open graded layer to be paid for shall be measured by the theoretical volume in place as shown on the drawings or as otherwise directed or approved for construction by the Engineer, placed and accepted in the completed graded crushed aggregate crack-relief layer.
- The quantity of asphaltic open graded crack relief layer shall be measured in cubic meters by taking out cores as detailed for Base Course Asphalt.
- The quantity of Asphaltic material is included in the mixture and shall not be measured separately.

16.3.5.4.2 Payments

The quantities determined as provided above shall be paid for at the contract unit price respectively for each of the particular pay items listed in the BOQs, which prices and payment shall constitute full compensation for all costs necessary for the proper completion of the work prescribed in this item.

Pay item code	Description	Unit
16-03	Graded Crushed Aggregate Crack-Relief Layer	CM or 100 cft.
16.3.5.4.2.2	Asphaltic Open-Graded Plant Mix Crack Relief Layer	CM or 100 cft.

16.3.6 Water Bound Macadam Base Course

16.3.6.1 Description

This work shall consist of furnishing and placing one or more courses of clean crushed stone base mechanically interlocked by rolling, and voids thereof filled with screening and binding material with the assistance of water, laid on a prepared sub-grade, sub-base or existing pavement in conformity with the lines, grades and cross-sections shown in the drawings. Unless otherwise directed by the Engineer this item of work may be applied to road structure or shoulders.

16.3.6.2 Material Requirement

16.3.6.2.1 Gradation Requirements

1. Coarse Aggregate

Coarse aggregates either crushed or broken stone shall conform to the quality requirements as specified hereunder, except that no CBR testing would be required. The gradation curve of the coarse aggregates shall be within the envelop limits given below. Gradation of class A is generally recommended.

Sieve Designation		Percentage by Weight		
mm	inch	Class A	Class B	Class C
102	4	100	-----	-----
89	3-½	90 – 100	-----	-----
76	3	-----	100	-----
63.5	2-½	25 – 60	90 – 100	100

50	2	-----	25 – 75	90 – 100
37.5	1-½	0 – 15	0 – 15	35 – 70
25	1	-----	-----	0 – 15
19	¾	0 – 5	0 – 5	0 – 5
12.5	½	-----	-----	-----

Table 10, Gradation Requirements for Coarse Aggregate

2. Fine Aggregate

Fine aggregates (filler material or screenings) shall consist of crushed stone screenings or any other line material approved by the Engineer. It shall be free from clay lumps, dirt and other objectionable material. The line aggregate shall be of the following Gradation.

Sieve Designation		Percentage Passing by Weight
mm	inch	
9.5	¾	100
4.35	No. 4	85 – 100
0.15	No. 100	10 – 30

Table 11, Gradation Requirements for fine Aggregate

The material passing No. 40 sieve shall have a liquid limit of not more than 25 and a Plasticity Index of not more than 6.

16.3.6.3 Physical Requirements

The additional physical requirements of coarse aggregates for water bound macadam would satisfy the following limits: -

- Los Angeles Abrasion Value Max 45 %
- Flakiness Index Max 15 %
- The loss when subject to 5 cycles of the Sodium Sulphate Soundness test (AASHTO T-104) shall be less than 12.

1. Binding Material

Binding material to prevent raveling of water bound macadam shall consist of a fine-grained material passing 100% through 425-micron sieve and possessing P.I. value of (4 – 9) when the Water Bound Macadam (WBM) is to be used as a surfacing course, and up to when WBM is being adopted as sub-base/base course with bituminous surfacing. If lime stone formations are available nearby, lime stones dust or as directed by the Engineer, may be used fully employed for this purpose.

16.3.6.4 Construction Requirements

16.3.6.4.1 Structure Preparation

- Preparation of surface for water bound macadam, shall be carried out in the same manner as for aggregate base course.
- Where the existing road surface is black topped, 50mm x 50mm furrows shall be cut in the existing surface at 1m intervals at 45° to the center line of the carriageway before proceeding with the laying of coarse aggregates.

- Before starting with WBM Construction, necessary arrangements shall be made for the lateral confinement of aggregates. One method is to construct side shoulders in advance to a thickness corresponding to the compacted layer of the WBM course. After shoulders are ready, their inside edges may be trimmed vertical and the included area cleaned of all spilled material thereby setting the stage for spread of coarse aggregates. The practice of constructing WBM in a trench section excavated in the finished formation must be avoided.

16.3.6.4.2 Spreading and Compaction

- Sufficient coarse aggregate shall be uniformly spread to give the required thickness for each layer when compacted. The compacted layer should not exceed 2½-times the thickness of maximum aggregate size.
- All patches or areas of fine or undersized aggregate shall be removed and replaced with suitable aggregate.
- The thickness of each layer shall be set by the use of depth blocks.
- Coarse aggregate shall not be spread more than 15000 sq. ft. and never more than 500 lin. ft. in advance of rolling and application of screenings.
- Spreading of the coarse aggregates shall be followed by rolling with a smooth wheel roller weighing at least 10-tons. Rolling shall begin at the lower edge of the shoulders to lock the stones firmly at the edge, then progress gradually towards the center line. Rolling shall continue until the aggregate is well keyed and does not creep ahead of the roller.
- In no case, shall coarse aggregates be stored in heaps directly on the area where these are to be laid nor shall then hauling over a partly completed base be permitted, however dumpers shall be allowed at the construction area where the material would be spread quickly after dumping.
- Following the initial rolling, dry screenings shall be applied uniformly over the surface. Dry rolling shall be continued while screenings are being applied. The surface shall be swept with mechanical or hand brooms to aid spreading of the screenings.
- When the interstices in the coarse aggregate are filled with screenings, the surface shall be sprinkled with water until it is saturated. The rolling, sprinkling and application of screenings shall continue until a grout is formed that fills all the voids and forms a wave of grout in front of the roller.
- When more than one layer is required to complete the Macadam base course to the thickness shown on the drawings, each layer shall be constructed as before prescribed.

16.3.6.4.3 Sprinkling

Immediately after the voids of a layer have been filled with screenings, the macadam shall be sprinkled with water, the sprinkler being followed by the roller. All excess screenings forming in piles or cakes on the surface shall be scattered by light sweeping. The sprinkling and rolling shall continue, and additional screenings shall be applied where necessary, until all voids are completely filled and the coarse stone firmly set and bonded. The quantity of screenings and water shall be sufficient to completely fill and bond the entire depth of the coarse aggregate and to produce a granular surface. Provision shall be made by the Contractor for furnishing water at the site of the work by equipment of ample capacity and of such design as to assure uniform application.

16.3.6.4.4 Density Requirement

As soon as proper conditions of moisture are attained the density tests shall be performed in accordance with AASHTO T 147 modified to include only material passing a ¾ inches sieve. If the density is less than 100 percent of the maximum density as determined by AASHTO T 180 (Modified Proctor), the contractor shall perform additional rolling as may be necessary to obtain that density.

16.3.6.4.5 Weather Limitation

- Water Bound Macadam work shall not be constructed during freezing weather or on a wet or frozen subgrade or subbase course.
- When temperature is below 40° F. complete base course shall be protected against freezing, until it dries out, by a sufficient covering of straw, hay, or other approved material.

16.3.6.4.6 Tolerance

The surface shall be true to the established grade. The surface shall not vary more than stipulated in accordance with below table.

Description	Thickness (mm)	Level (mm)	5M Straight-edge (mm)	Cross-fall (%)	Longitudinal Grade in 30 M (%)
Sub-Grade	±20	+0 -40	30	± 0.5	± 0.1
Subbase (Gradation or Stabilized)	+10 -20	+0 -25	20	± 0.3	± 0.1
Base Course (Granular or Stabilized)	+5 -10	+5 -10	6	± 0.2	± 0.1
Asphaltic Base Course	+3 -10	+3 -10	6	± 0.2	± 0.1
Asphaltic Wearing Course	±3	±3	5	± 0.2	± 0.1
Concrete Pavements	+10 -5	+10 -5	5	± 0.2	± 0.1

Table 12, Tolerance values

16.3.6.4.7 Quality Control Testing

Tests for compliance with the quality control requirements will be made as often as deemed necessary and according to sequence of testing as stipulated in table given below.

Material	Test	Designation *	Sampling and Testing Frequency
Aggregate (Crushed)	Gradation	AASHTO T-27	Same as for Aggregate base Course
Aggregate (Asphaltic open-graded plant mix)	Gradation	AASHTO T-27	Same as for coarse aggregate under Asphaltic Base Course Plant Mix
Asphalt Cement	-	-	Same as for Asphaltic Base Course Plant Mix

Mixture	Asphalt Coating	AASHTO T-195	1/day's production or as required based on visual observation
---------	-----------------	--------------	---------------------------------------------------------------

Table 13, Quality Control Testing

16.3.6.4.8 Maintenance

The completed base course shall be maintained in an acceptable condition until the necessary subsequent treatment is applied.

16.3.6.5 Measurements and Payments**16.3.6.5.1 Measurements**

The quantity of Water Bound Macadam Base to be paid for shall be measured by the theoretical volume in place, as shown on the drawings or as directed and approved for construction by the Engineer, placed and accepted in the completed Water Bound Macadam Base Course. No allowance would be given for materials placed outside the theoretical limits shown on the cross-sections. The quantity of asphaltic open graded crack relief layer shall be measured in cubic meters by taking out cores as detailed for Base Course Asphalt. The quantity of Asphaltic material is included in the mixture and would not be measured separately.

16.3.6.5.2 Payments

The accepted quantities determined as provided above shall be paid for at the contract unit price per cubic meter or per 100 cubic ft of Water Bound Macadam Base, for the pay items listed in the BOQs, which prices and payment shall constitute full compensation for furnishing all materials, hauling, placing, watering, rolling, labour, equipment, tools and incidentals necessary to complete this item.

Pay item Number	Description	Unit
16.3.6.5.2.1	Water Bound Macadam Base with Coarse Aggregate: for all classes (A, B & C)	CM or 100 cft.

16.3.7 Deep Patching

This work shall be carried out in patches of roads where the existing mud base material has moved and is lying in loose condition. Requirement under this item is to remove the existing road base and to strengthen it to lake new layer of aggregate or water bound macadam base.

16.3.7.1 Material Requirement

Fresh aggregate base or water bound macadam base may be required to be added to existing road base. Specifications for such material shall conform to material requirement of sub section 16.3 'Aggregate Base Course' of Section 'Sub Base and Base'.

16.3.7.2 Construction Requirement

Patches of roads in which surface courses have broken and road base has moved, the material which has lost its, compaction shall be removed. Next layer shall be watered and compacted, thereby the removed material shall be placed back duly screened to remove plastic contamination, by hand picking and passing though sieve No. 4. after properly watering

and mixing. Material would be re-compacted in layers not exceeding 15cm thick with approved equipment's. Additional material would be added, if needed particularly non-plastic passing sieve No. 4.

16.3.7.3 Measurement and Payments

16.3.7.3.1 Measurement

The quantity of deep patching to be paid for shall be measured in square meter of the area demarcated or approved by the Engineer. The minimum area would be taken as 0.5m² irrespective of the size of the pot hole.

16.3.7.3.2 Payment

The accepted quantities measured as provided above shall be paid for at the contract unit price per square meter of deep patching, which price payment shall constitute full compensation for furnishing all materials, hauling, placing, watering, rolling, labour, equipment, tools and incidentals necessary to complete the item: -

Pay item Number	Description	Unit
16.3.7.3.2.1	Deep Patching (0-15 cm)	SM
16.3.7.3.2.2	Deep Patching (15-30 cm)	SM

16.3.8 Reinstatement of Road Surface

This work shall consist of reinstatement or worn out road surface with a material approved by the Engineer. Pot holes, ditches and depressions shall be filled with the approved materials in layers in conformity with lines, grades, sections and dimensions, as directed by the Engineer.

16.3.8.1 Material Requirement

The material used under this item shall conform to the material requirement of different BOQ items selected by the Engineer.

16.3.8.2 Construction Requirement

The Contractor shall remove loose material from the pot holes or from road depressions and shall also reshape the holes and depression by removing firm material as directed by the Engineer and dispose all material according to the instruction of the Engineer. The surface thus exposed shall be compacted in accordance with applicable requirement, for reinstatement of surface the Engineer shall select shall select item of work as mentioned here under: -

- Granular sub-base
- Aggregate base course
- Water bound macadam
- Asphalt base course
- Surface treatment

The Engineer may select one, or more than one of the items mentioned above to reinstate the pot hole or depressions in the road surface according to size and depth of the hole or depression.

16.3.8.3 Measurement and Payments

16.3.8.3.1 Measurement

- The quantities to be paid for shall be the number of square meters of pot holes or road depressions, reinstated in accordance with the requirement of this item.
- The material used for reinstatement of the pot hole or road depression shall be measured in cubic meter or tones as applicable under the item used.

16.3.8.3.2 Payment

The accepted quantities measured, as provided above shall be paid for at the contract unit price per square meter of reinstated surface, as for the pay item listed below and as shown on the bill of quantities which price shall constitute full compensation for excavation and disposal of material, watering, rolling, labour, equipment, tools, and incidental necessary to complete this item. However, the material used such as subbase, aggregate base course, water bound Macadam or asphaltic base course shall be paid at the rates applicable to the item.

Pay item Number	Description	Unit
16.3.8.3.2.1	Reinstatement of Road Surface	SM

16.3.9 Pavement Widening

16.3.9.1 Description

This work shall consist of the widening of the existing pavement and finishing of the completed work in accordance with the Specifications and in conformity with the lines, grades, thickness of each pavement component and typical cross-sections shown on the plans or as directed by the Engineer.

16.3.9.2 Materials

Materials for the construction of "Pavement Widening" shall conform to the requirements specified in relevant items of Sub-base and Base course in these Specifications.

16.3.9.3 Trenching

The Contractor shall excavate along the edge of the existing pavement for the full depth and width or as directed by the Engineer. The bottom of the trench shall be compacted with rollers and/or tampers approved by the Engineer to minimum 95% of the maximum dry density as per AASHTO T-191 method. If the plans do not call for a specified type of compaction, the subgrade, sub-base or base shall be compacted by rolling with an approved type trench roller until the entire surface is smooth, firm and at the designated elevation. Adequate provisions shall be made for drainage of the trench to prevent damage to the subgrade. Prior to placing any widening material, the trench shall be cleaned of all loose material. The edge of the existing pavement shall be thoroughly cleaned. The trench must be approved by the Engineer,

before placing any widening material. All subsequent layers shall be compacted to the degree as shown under relevant item of these Specifications.

16.3.9.4 Special Provisions for Handling Traffic

- Widening operations shall be permitted on only 1 side of the pavement at a time and excavation of trenches shall be permitted only sufficiently in advance of other operations to ensure a continuity of the operations of excavating, placing widening material, and rolling.
- Reflectorized barricades shall be placed along open trenches day and night. Lighting shall be placed at each barricade at night. Barricades and lights shall be approved by the Engineer. The barricades shall be placed at intervals not to exceed 100m or as directed by the Engineer.
- The Contractor shall make adequate provision to enable traffic to cross open trenches at intersecting roads, streets and private entrances.
- Partial shouldering shall be performed immediately after completion of widening. Of portions of the Work in order to eliminate the hazard.
- No separate payment Would be made for handling traffic which would be considered subsidiary to the item of "Pavement Widening."

16.3.9.5 Measurement and Payment

16.3.9.5.1 Measurement

"Pavement Widening" shall be measured by the unit of cubic meter and shall include all excavation, trimming, disposal and compaction of subgrade and subsequent layers of sub-base and base dowse. The removal of edge Curb if exists, would not be paid for separately but would be considered subsidiary to the item of "Pavement Widening." Water, ordered by the Engineer or added with the consent of the Engineer, which is necessary to obtain satisfactory compaction of the foundation treatment would not be paid for separately, but would be considered subsidiary to the item of "Pavement Widening". No Measurement would be made of unauthorized areas or for extra width or thickness.

16.3.9.5.2 Payment

The amount of completed and accepted Work, measured as provided above, will be paid for at the unit price bid in the Bill of Quantities for "Pavement Widening," which price shall be full compensation for furnishing materials, such as subbase, base course and water etc., for all labour, equipment, tools, supplies, and all other items necessary for the proper completion of the Work.

Pay item Number	Description	Unit
16.3.9.5.2.1	Pavement Widening	CM

16.3.10 Lime Stabilized Aggregate Base Course

16.3.10.1 Description

This work shall consist of performing all operations in connection with construction of "Lime Stabilized Aggregate Base Course" on the prepared Sub-base or Subgrade surface and all

incidentals in accordance with the Specifications in conformity with the lines and level grade, and typical cross-sections shown on the plans.

16.3.10.2 Material Requirement

1. Coarse Aggregate

Course Aggregates for crushed Lime Stabilized Base Course limestone, particles free from thin and elongated, soft and disintegrated material or other objectionable matters, comply with the following requirements.

Sieve Designation		Percentage Passing by Weight
mm	inch	
37.5	1-½	100
25	1	80 – 100
12.5	½	50 – 80
4.75	No. 4	30 – 60
0.425	No. 40	10 – 30
0.075	No. 200	5 – 15

Table 14, Crushed Stone Grading

- The fraction of material passing 0.075 mm (No. 200) sieve shall not be more than 60% the fraction passing 0.425 mm (No. 40 Sieve).
- Crushing of boulder or rock shall be regulated in such a way that friction of aggregates retained No. 40 (0.425 mm) sieve shall contain at least 90% by weight of crushed particles having more than one mechanical fractured faces.
- The Abrasion loss of Crushed Lime Stone as determined by AASHTO T-96-74 shall not exceed 45%.

2. Fine Aggregate

- The fraction of crushed aggregates passing No. 4 sieve shall consist of stone screenings free of loam, organic or other matter.
- The material passing 0.425 mm (No. 40) Sieve when prepared in accordance with AASHTO T-146-49 and tested by appropriate methods shall conform with the following requirement: -

Liquid Limit	25% Maximum
Plasticity Index	6 Maximum

- The calcium Sulphate content of the fraction retained on sieve No. 4 shall not exceed 10% by weight.

16.3.10.3 Construction Requirement

16.3.10.3.1 Equipment

- All equipment, tools and machines used in the performance of the work shall be in good working condition and maintained all the times.
- Blade graders, if used for spreading, the material shall have adjustable blades for slopes.

- All sprinkling equipment shall be suitable for applying water uniformly and at controlled quantities to variable width of surface.
- Transport vehicles carrying plant mix material shall have a capacity suited to the output of mixing plant and the site condition.
- Mixing plant shall be of approved type, coordinated and operated so as to produce a mixture within required Specifications limit and shall have sufficient capacity.

16.3.10.3.2 Construction

- Grade and alignment control stakes shall be furnished, set and maintained by the Contractor in order that work shall conform to the line, grade and cross-section shown on the drawings.
- Material shall be placed and spread evenly using mechanical spreader. The spreader shall, be adjustable so that width and thickness of the spreader can be set to any dimension required by the drawings and for uniform and complete coverage.
- Aggregate shall be spread to loose thickness necessary to obtain the required compacted thickness of the layer.
- Immediately after spreading and shaping operation, the mixture shall be thoroughly compacted with approved rollers. Water shall be applied to the materials during the rolling operation in such amount as may be required to obtain the specified density. In all the places not accessible to the rolling equipment, the material shall be compacted thoroughly with approved mechanical or hand tampers to density comparable to that obtained by rolling. The surface of the final layer shall be finished by binding and the addition of water, until the surface is smooth and free from waves and irregularities and is true to grade and cross-section. Where the thickness exceeds 12.5cm, it shall be compacted in 2 layers of equal, thickness except that if vibratory roller is used for compaction, the layer thickness may be increased to maximum of 25cm provided that satisfactory compaction is achieved.
- Each layer shall be compacted until the entire depth of course is at least 95% of density at optimum moisture content as determined by AASHTO T-180-74. Compaction shall be completed as soon as possible after the Material has been spread.

16.3.10.3.3 Thickness and Finish

Completed base course shall be tested for the required thickness and smoothness before acceptance. Any areas of the completed base course having compacted thickness less than the thickness shown on the drawing, or waves and irregularities as specifiable in the relevant, "Table for Allowable Tolerances", in these Specifications shall be corrected by scarifying the surface, adding approved material, reshaping, recompacting and finishing as specified and as approved by the Engineer. Skin patching of an area without scarifying the surface to permit proper bonding of added material would not be permitted.

16.3.10.3.4 Maintenance

The completed base course shall be maintained in an acceptable condition at all times until prime coat is applied. When the base course is to carry traffic for an indefinite length of time before receiving the surfacing or pavement, the Contractor shall maintain the surface until final acceptance and shall prevent releveling by wetting, blading, rolling and the addition of fines as may be required to keep the base tightly bound and leave a slight excess of material over the entire surface, which must be removed and the finish restored before the application of prime coat.

16.3.10.4 Measurement and Payment**16.3.10.4.1 Measurement**

The unit of Measurement for payment shall be in cubic meter of the completed and accepted crushed lime stone base course as measured in place. Measurement shall not include any area in excess of that shown on the drawings except the area authorized in writing by the Engineer. Measurement of lime used shall be the number of metric Ton consumed to stabilize base course. This quantity of lime used shall not exceed the theoretical percentage established in the laboratory.

16.3.10.4.2 Payment

Measured quantities of crushed limestone base course determined as above shall be paid for at the contract unit price per cubic meter for particular item listed below and shown on the bill of quantities, which payment shall be full compensation for furnishing all labour, material, tool, plant, equipment; handling, mixing, manipulating, placing, shaping, compacting including necessary water for compaction, rolling, finishing; correcting unsuitable areas and unsatisfactory material; maintenance including protection of prepared base course and all incidentals necessary for completion of work except lime used which shall be paid separately as measured above.

Pay item Number	Description	Unit
16.3.10.4.2.1	Lime Stabilized Aggregate Base Course	CM
16.3.10.4.2.2	Lime	Ton

16.3.11 Bitumen Stabilized Subbase or Base**16.3.11.1 Description**

This work shall consist of performing all operation in connection with construction of bitumen stabilized sub-base or base and all incidentals in conformity with the lines and level, grade, thickness and typical cross-section shown on the drawings or as directed by the Engineer.

16.3.11.2 Material Requirement

- If stationary plant is used for blending, all ingredients shall comply with any of the grading curve given in Table 1 whereas for mix in place method, in situ sand and gravel shall meet the Graduation requirement as per Table 2 for bitumen stabilized Subbase or Base Course.
- Coarse aggregate retained on 4.75 mm (No. 4) sieve shall consist of tough, hard and durable particles free from decomposed stone, organic matter and other deleterious substances.
- Crushing of material shall be regulated such that material retained on 4.75mm (NO. 4) sieve shall have 50% by weight of total aggregates with at least two (2) mechanically fractured faces in case of bitumen stabilized subbase whereas for bitumen stabilized base, material retained on No. 4 sieve shall have at least Ninety (90) percent by weight of total aggregate with two (2) mechanically fractured faces.

- Aggregate retained on sieve No. 4 shall have a percentage of wear by Los Angles Abrasion Test as determined by AASHTO T-96 not more than forty-five (45) percent in case of base course material and fifty (50) percent in case of sub-base material.
- Fraction passing 0.075mm (No. 200) sieve shall not be greater than 2/3 rd. of the fraction passing the 0.425mm (No. 40) sieve. The fraction passing 0.425 mm (No. 40) shall have a liquid limit not greater than 25% and plasticity Index not greater than 6.
- If mineral aggregates contain moisture thus necessitating drying, bitumen material shall be of such nature that it will not foam when heated to hundred and eighty (180) degree centigrade and shall conform with requirements.
- In dry areas, where natural moisture content of mineral aggregate is low bitumen binder shall be cut back conforming with the following requirements. Cut back shall meet the requirement of AASHTO M 81-70 and M 82-73 for rapid and medium curing type respectively. It shall comply with the requirements of AASHTO T 49-74, T 50-69, T 78-74 for the selected grade to suit the cutback as approved by the Engineer. Alternatively, the bituminous binder shall be asphaltic cement of 80/100 penetration in summer and 120/150 in winter; bitumen emulsion of 80/100 penetration in summer and 150/180 penetration in winter. The bituminous emulsion shall comply with the requirements of AASHTO M 100-70 and be tested in accordance with AASHTO T 59-74.
- Bitumen-Aggregate mixture for the grade of bitumen selected shall be ascertained by trial mixes using Marshal Method to determine the amount by weight of dry material, and using either heated or unheated aggregates as appropriate.

Characteristic	Sub-base	Base
Marshal Stability (min.)	250 kg	400 kg
Flow (min.)	2 mm	2 mm

Table 15, Tentative Criteria for Bitumen Aggregate Sub-base/Base Material

Sieve Designation		Percent Passing by Weight		
mm	inch	Type A	Type B	Type C
75	3	100	-----	-----
50	2	90 – 100	100	-----
25	1	55 – 90	70 – 100	100
9.5	¾	35 – 65	50 – 80	65 – 95
4.75	No. 4	25 – 55	40 – 65	50 – 80
2	No. 10	20 – 40	30 – 50	40 – 65
0.425	No. 40	10 – 25	15 – 25	20 – 35
0.075	No. 200	3 – 10	3 – 10	3 – 10

Table 16, Selected Granular Sub-base/Base Material Grading

Sieve Designation		Percentage Passing by Weight
mm	inch	
37.5	1-½	100
25	1	80 – 100
12.5	½	50 – 80
4.75	No. 4	30 – 60
0.425	No. 40	10 – 30
0.075	No. 200	5 – 15

Table 17, Sand- Gravel Sub-base Material- Grading

- Fine aggregate passing 4.75mm (no. 4 Sieve) shall consist of sharp natural sand, free from organic or other objectionable substances.

16.3.11.3 Construction Requirement

All equipment, tools, machines used in the performance of work shall be in good working condition and be subject to the approval of the Engineer, and shall be maintained in satisfactory working condition at all times. Blade grader if used shall have an adjustable blade for slopes and shall be self-propelled.

16.3.11.3.1 Mix in Place Method of Construction

Mix in place method of construction may be adopted where the use of low viscosity binder i.e. Cutback or Bitumen emulsion are found suitable.

- Grade and alignment control stakes shall be furnished, set and maintained by the Contractor in order that work shall conform to the line, grade and cross-section shown on the drawings. The stakes shall be set in rows on and parallel to the center line of pavement and spaced so that string line may be stretched between them.
- All material shall be placed evenly using mechanical spreader or spreader box operated with a mechanism which levels off the surface to an even depth.
- Mixing shall be accomplished on one or more passes of the mixer through the material and shall be continued until the resulting mixture is entirely uniform and of proper moisture content. Moisture content, if less than required, shall be adjusted by sprinkling equipment, which shall be suitable for applying water uniformly and at controlled amount to variable depth of layer.
- Areas of segregated material shall be corrected by removing and replacing with satisfactory material or by re-mixing. When necessary to meet the requirement of specified, additional approved material shall be spread in such amounts as are found to be necessary and the added material shall be uniformly spread adding water if required to obtain the specified density.

16.3.11.3.2 Stationary Mixing Plant Method

Stationary plant method of construction would be used where stabilization with asphalt cement binder of penetration grade 80/100 is necessary.

- The mixing plant shall be designed, coordinated and operated so as to produce mixture within required Job-Mix-Formula and shall have sufficient capacity. The plant shall be weighing batch type.
- Transport vehicles carrying plant mix material shall have a capacity suited to the output of mixing plant and the site condition and be capable of discharging cleanly. Segregation of material shall be avoided.

16.3.11.3.3 Compaction

- Immediately after spreading, shaping to required level, crown and grade, the mixture shall be thoroughly compacted with rubber or pneumatic tired rollers. Compaction shall continue until the entire depth and width of Sub-base/Base is uniformly compacted. Rolling shall begin at the low side and progress towards the higher side overlapping each preceding trip until entire surface has been rolled. Alternate trip of roller shall be of slightly different length. Roller shall be in good working condition, capable of reversing without back lash and shall be operated by skilled operator.

- Compaction shall be checked on stabilized layer in accordance with ASTM Description 915-61 (1973). The density of the mixture shall not be less than 98% of the laboratory bulk density. Deficient pavement shall be removed and replaced with satisfactory material.

16.3.11.3.4 Tolerance

Tolerance in the compacted layer shall be as specified in the relevant, "Table for Allowable Tolerances" in these Specifications.

16.3.11.3.5 Curing and Maintenance

- After compaction, the stabilized Sub-base/Base shall be protected against damage and maintained in an acceptable condition at all times prior to the construction of subsequent courses.
- No vehicular traffic shall be allowed to pass on the stabilized surface for a minimum period of 2-days.

16.3.11.3.6 Weather Limitation

Laying of bitumen stabilized base/sub-base shall be avoided when air temp is 4°C or below or when weather is rainy or foggy. Placing of mixture shall also be avoided when surface is wet or on any surface which is frozen or covered with ice or snow.

16.3.11.4 Measurement and Payment

16.3.11.4.1 Measurement

The unit of Measurement for payment shall be cubic meter for the compacted and accepted bitumen stabilized sub-base/base course as measured in place. Measurement shall not include any area except the area authorized in writing by the Engineer. Measurement of bitumen binder used shall be the number of metric Ton used to stabilize sub base or base course. The quantity of bitumen used shall not exceed the theoretical percentage established in the laboratory.

16.3.11.4.2 Payment

Measured quantity of stabilized Subbase/Base determined as above shall be paid for at the contract unit price per cubic meter for particular items listed below and shown on the bill of quantities, which payment shall be full compensation for furnishing of labour, material, tool, plant, equipment, handling, mixing, manipulating, placing, shaping, compacting, rolling, finishing, correcting unsuitable areas and unsatisfactory material, maintenance including protection of stabilized Subbase/Base and all incidentals necessary for the completion of work except bitumen consumed which shall be paid separately as measured above.

Pay item Number	Description	Unit
16.3.11.4.2.1	Bitumen Stabilized Sub- Base	CM
16.3.11.4.2.2	Bitumen Stabilized Base Course	CM
16.3.11.4.2.3	Bitumen Binder	Ton

16.3.12 Cold Recycling of Road Pavement Structure/ Soil Stabilization

16.3.12.1 Description

This item shall consist of breaking, removal, mixing, relaying and compaction of layers of surface, base and sub-base course in a single operation. In this operation, addition of water or binder would also be required to add strength to the mix.

16.3.12.2 Material Requirement

No fresh material is to be used as far as quarry materials are concerned. However, in order to achieve proper strength of the relayed material; water, cement or bitumen binder may be required to be added. Specification requirements of these ingredients shall be same as described under relative items of Work. Cement and bitumen binder of following nomenclature shall be used.

- Ordinary Portland cement (Type-1)
- Emulsified asphalt (RS-1, RS-2, SS-1, SS-1h)

16.3.12.3 Construction Requirement

16.3.12.3.1 Equipment

Equipment utilized for this item of work, ensure following activities in a single operation: -

- Breaking of layers in full depth in single operation.
- Pulverizing and mixing of different types of materials to give homogeneous mix.
- Mixing of water or bitumen binder in the total mass.
- Laying of treated material in smooth layer, keeping the grade and line as per design.

16.3.12.3.2 Cold Recycling of Asphalt

1. Milling Process

This work shall be carried out by specialized equipment designed to break and pulverize the asphaltic layer in a manner that maximum size of broken material reduces to basic size of aggregates. Asphaltic material lumps shall be reduced to a maximum size of 15mm.

2. Additives

Bitumen binder (Emulsified Asphalt) shall be added to the mix through a computerized, electronically controlled unit for selecting and measuring the required amount. Bitumen binder and additives shall be added with pump and spray/injection system. Quantity of bitumen binder shall be controlled by programmable microprocessors with respect to forward speed, milling depth, milling width and density of material.

3. Mixing and Laying

Milled materials and additives shall be mixed in a forced mixer to make the mass completely homogeneous. Material thus prepared shall be relayed through paving block having tamping

and vibrating paving screeds. Paving screeds shall be designed to provide initial compaction and shaping the surface to give the required grade and profile.

4. Compaction

Initial compaction shall be provided with paving screeds, however final compaction shall be carried out with conventional rolling equipment approved by the Engineer considering the type of material and thickness of recycled layer. However final compaction shall be checked after completion or rolling as determined by AASHTO T-230 method and shall not be less than 97% of the Marshall density. Total width of road asphalt shall be recycled in a number of strips, depending on width of recycling equipment and width of road. However, all longitudinal and lateral joints shall be properly worked up to ensure smooth riding quality.

16.3.12.3.3 Soil Stabilization

1. Milling Process

This work shall be carried out by specialized equipment designed to break and pulverize asphaltic layers and base and sub-base courses to a depth of maximum 300mm in a single operation. Breaking and pulverizing shall ensure reduction or binding material to reduce to a size of 50mm (maximum) or to a smaller size depending on the thickness of recycled layer.

2. Additives

Water shall be added to the mix through a computerized, electronically controlled unit for selecting and measuring the required amount, water shall be added with pump and spray/injection. Quantity of water shall be controlled by programmable microprocessor with respect to forward speed, milling depth, milling width and density of materials.

3. Mixing and Laying

Milled materials and additives, shall be mixed in a forced mixer to make the mass completely homogeneous. Material thus prepared shall be recycled through paving block having tamping and vibrating paving screed. Paving screeds shall be designed to provide initial compaction and shaping the surface to give the required grade and profile.

4. Compaction

Initial compaction shall be provided with paving screeds, however final compaction shall be carried out with conventional rolling equipment approved by the Engineer considering the type material and thickness of recycled layer. However final compaction shall be checked after completion of rolling as determined by AASHTO T-230 method and shall not be less than 95% of the modified proctor density.

5. General

Total width of road asphalt shall be recycled in a number of strips, depending on width of recycling equipment and width of road. However, all longitudinal and lateral joints shall be properly worked up to ensure smooth riding quality.

16.3.12.4 Measurement and Payment

16.3.12.4.1 Measurement

- The quantity of cold recycling or soil stabilization to be paid for shall be measured by the theoretical volume recycled as shown on the drawings or as directed by the Engineer, completed in place as per procedure detailed above. No allowance shall be given to material laid outside approved theoretical limits.
- Measurement for bitumen binder shall be made in tons delivered to the equipment for work minus the balance left in the equipment.
- Measurement for cement shall be made equal to the number of tons of cement delivered and laid over the pavement in manner described above.

16.3.12.4.2 Payment

The accepted quantities measured as provided above, shall be paid for at the contract unit price for each of the particular pay item listed below, which price and payment shall constitute full compensation for furnishing all materials, labour, equipment's, tools and incidentals to complete the item.

Pay item Number	Description	Unit
16.3.12.4.2.1	Cold Recycling of Asphaltic layer	CM
16.3.12.4.2.2	Soil Stabilization	CM
16.3.12.4.2.3	Bitumen Binder (Asphaltic Emulsion)	Ton
16.3.12.4.2.4	Cement Binder (O.P.C – Type-I)	Ton

16.3.13 Asphaltic Concrete Binder Course**16.3.13.1 Description**

This work shall consist of furnishing and mixing aggregates and asphalt binder at a central mixing plant, transporting, spreading and compacting the mixture on a prepared base in accordance with these Specifications and to the lines, grades and typical pavement sections shown on the Drawings or as directed by the Engineer.

16.3.13.2 Material Requirement**16.3.13.2.1 Aggregate**

- Coarse and fine aggregates shall be clean, hard, tough, sound particles free from decomposed material, vegetable matter and other deleterious substances, and be of uniform quality, geology and petrology. Water borne material such as river bed gravel, if used shall also conform to the above criteria.
- Coarse aggregate, which is material retained on the No. 4 sieve, shall consist of crushed rock, crushed gravel or a mixture of natural and crushed gravel. The aggregate shall contain no more than 8% by weight of flats/or elongated particles (ratio maximum to minimum 5:1) and shall contain 100 % angular material, such that all faces of each piece are fractured faces in cuboids shape.
- Fine aggregate, which is material passing the No. 4 sieve shall consist of 100% crushed material from rock or boulder. No natural sand would be allowed in the mix.

- When the combined grading of the coarse and fine aggregates is deficient in material passing the No. 200 sieve, additional filler material shall be added. The filler material shall consist of finely divided rock crust, hydrated lime, hydraulic cement or other suitable mineral matter and shall conform to the following Gradation.

US Standard Sieve	Percentage Passing by Weight
No.30	100
No. 50	95 – 100
No 200	70 – 100

Table 18, Gradation Requirements

- The Coarse and fine aggregates shall meet the following requirements: -
 - The percentage of wear by the Los Angles Abrasion test (AASHTO T-96) shall not be more than 40%.
 - The loss when subject to 5-cycles of the Sodium Sulphate Soundness test (AASHTO T-140) shall be less than 12%.
 - The Sand Equivalent (AASHTO T-174) determined after all processing except for addition of asphalt cement shall not be less than 45.
 - All aggregates shall have a liquid limit of not more than 25% and a Plasticity Index of not more than 4 as determined by AASHTO T-89 and T-90.
 - The portion of aggregate retained on the 9.5 mm (3/8-inch) sieve shall not contain more than 15% by weight of flat and/or elongated particles (ratio of maximum to minimum dimensions = 2.5:1).

16.3.13.2.2 Asphaltic Material

Asphaltic binder to be mixed with the aggregate to produce asphaltic base shall be as asphalt cement penetration grade 40-50, or 60-70 or 80-100, as specified by the Engineer. Generally, it would meet the requirement of AASHTO M-20.

16.3.13.2.3 Asphaltic Concrete Binder Course Mixture

The composition of the asphaltic concrete paving mixture for binder course shall conform to class shown in the following table: -

Sieve	Designation	Percent Passing by Weight
mm	Inch	
25	1	100
19	3/4	90-100
9.5	3/8	56-80
4.75	No. 4	35-65
2.38	No. 8	23-49
0.30	No. 50	5-19
0.075	No. 200	2-8

Table 19, Combined Aggregate Grading Requirements

Asphalt Content Weight Percent of total mix.	3.5 Minimum
The Asphalt Concrete binder course mixture shall meet the following Marshal Test Criteria;	

Compaction, number of blows each end of Specimen	75
Stability (Minimum)	1000 Kg
Flow, 0.25 mm (0.01")	8-14
Percent air voids in mix.	4-8
Percent voids in mineral aggregate	According to article 5.3, MS-2, (Asphalt Institute USA) edition 1993
Loss of Stability	25 % (Max.)
Filler/ Bitumen ratio	1-1.5 (applicable to hot climate) (>40°C.)

Table 20, Marshal Test Criteria

16.3.13.2.4 Combined Aggregate Gradation

- Retained No. 4 + 7.0 %
- Passing No. 4 to No: 100 sieve + 4.0 %
- Passing No. 200 + 1.0 %

16.3.13.2.5 Asphalt Content

- Weight percent of total mix + 0.3 %

Shall a change of sources of materials be made a new Job Mix. Formula shall be established before the new material is used. When unsatisfactory results or other conditions made it necessary, a new Job Mix Formula would be required.

16.3.13.2.6 Job-Mix Formula

- At least one week prior to production, a Job-Mix Formula (JMF) for the asphaltic concrete course mixture or mixtures to be-used for the project, shall be established jointly by the Engineer and the Contractor.
- The JMF, with the established by Marshal Method of Mix Design according to the procedure prescribed in the Asphalt Institute Manual Series No. 2 (MS-2), May 1992 Edition.
- The JMF, shall be allowable tolerances, shall be within the master range specified in this chapter. Each JMF shall indicate a single percentage of aggregate passing each required sieve size and a single percentage of bitumen to be added to the aggregates.
- After the JMF is established, all mixtures furnished for the project represented by samples taken from the asphalt plant during operation, shall conform thereto with the tolerances as per these Specifications.

16.3.13.3 Construction Requirement

Construction requirements for this item shall conform to the same construction requirements specified for Asphaltic Concrete Base Course Plant Mix under Section 'Asphaltic Base Course Plant Mix' of this chapter. except as modified in the following sub-items.

16.3.13.4 Measurement and Payment**16.3.13.4.1 Measurement**

The quantities of asphaltic binder course shall lie measured per cubic meter basis. The quantity of asphaltic material used is included in the asphalt concrete mixture and would not be measured separately. Quantities of liquid asphalt, wasted or remaining on hand after Completion of the work, shall not be measured or paid for.

16.3.13.4.2 Payment

The quantities determined, as provided above, shall be paid for at the contract unit price respectively for each of the particular pay item listed below and shown in the Bill of Quantities, which prices and payment shall constitute full compensation for all the costs necessary for the proper completion of the work prescribed in this item: -

Pay item Number	Description	Unit
16.3.13.4.2.1	Asphalt Concrete Binder Course.	CM

16.3.14 Geotextiles

16.3.14.1 Description

The work covered by this section shall consist in furnishing all material, labour, equipment and placing of Geotextiles on prepared surfaces complete in accordance with the Specifications for the work items involved, in thicknesses and to the dimensions shown on the typical cross-sections of applicable drawings or as directed by the Engineer.

16.3.14.2 Geotextiles Functions

Where indicated on the drawings or directed by the Engineer, Geotextile would be placed to perform one or more of the following functions: -

- On road foundation for the purpose of separation between road fill material and soft underlying soils in order to eliminate the need for removal of poor subsoil material and quick and effective drainage of soil-fill interface.
- For subgrade stabilization and increasing soil shear strength by provided bonding mechanism of the Geotextile - soil system.
- As a filter for all drainage systems where a danger of clogging by fine particles of adjacent soil is possible. The Geotextile would retain the particles from passing whilst allowing the seepage water to pass through.
- As a filler element for all bodies of water where the soil can be eroded by current, wave action or changing water levels.
- For permanent protection of synthetic scaling systems (Geo-membranes) against mechanical damage during installation and after completion of construction

16.3.14.3 Material Requirement

1. Composition and Environmental Behavior

The raw material of Geotextile shall be Ultra Violet stabilized polypropylene. The fibers shall consist of continuous filaments of approximately 40-micron diameter and mechanically bonded by needling. The Geotextile material shall be resistant to acid and alkaline Media in the pH range 2 to 13, resistant to lime, cement and concrete, resistant to all naturally occurring

bacteria and fungi. A prolonged outside exposure of several months shall have no effect on the properties of Geotextile.

2. Mechanical and Hydraulic Properties

- To ensure free drainage, the Geotextile shall have high water permeability.
- Geotextile shall offer high retention capability for almost all types of soils.
- The Geotextile shall have Optimum stress-strain behavior even with low unit weight for high resistance against installation damage.

16.3.14.4 Construction Requirement

The surface shall be fairly leveled before placement of Geotextile. It is to be ensured that there are no protruding stones which may damage the Geotextile fabric. The Geotextile shall be rolled out directly on top of the prepared surface in a manner as recommended by the manufacturer. It shall be over lapped at the edges as shown on the drawings or as recommended by the manufacturer.

1. Placement of fill

The first layer of fill material shall be applied by overhead placement. Traffic on the Geotextile itself shall be avoided. Necessary precautions shall be observed to ensure that Geotextile shall not be damaged during placement.

2. Spreading

Spreading of fill material shall be done with suitable equipment and procedure ensuring that Geotextile must not be damaged by high axle load stresses of spreading equipment traveling on sharp fill over the Geotextile.

3. Compaction

The compacting method (Static/Dynamic) shall be suited to subgrade/fill material.

4. Jointing of Geotextile Panels

A tension joint shall be achieved by overlapping, welding or sewing as shown on drawings or approved by the Engineer.

5. Overlapping

Overlapping width shall not be less than 30cm on even surface and 50cm on uneven surface. In order to avoid displacing the Geotextile during backfill over end panel joints, the connecting panel must be placed underneath the end of the previously rolled out Geotextile.

6. Welding

Welding width shall not be less than 10cm a wide pattern gas torch shall be used at a low temperature and about 20cm from the Geotextile. The welded Geotextile section shall be continuously pressed down by walking on it during placement.

7. Sewing

The stitching method shall be single thread, double thread or butterfly type suitable to Geotextile thread type and strength. The thread shall be sufficiently tightened and stitch density shall be three to six stitches per inch.

16.3.14.5 Geotextiles Functions for Repaving

This section deals Geotextiles placed between old pavement and new asphalt overlay, along with suitable tack coat of bitumen. Where indicated on drawings or directed by the Engineer, Geotextile would be placed to perform one or more of the following functions.

- To ensure proper adhesion between old pavement and new asphalt overlay & thus reducing the overall flexural tensile stresses and increasing life of road surface.
- As a cut, off layer for the prevention of propagation of cracks in the pavement.
- As water barrier, even under high pressure to stop reflective cracking in the pavements.

16.3.14.5.1 Construction Requirement

Before construction starts, the contractor shall ensure: -

- Removal of dirt, dust and vegetation from wearing surface and cracks.
- Filing potholes and larger cracks (>5mm) with hot mix or an adequate filler.
- Removal of sharp or craggy edges on surface.
- On badly damaged roads, a level course of approx. 1.5cm shall be laid to avoid the labor intensive and time-consuming operation of crack filling.

16.3.14.5.2 Applying the tack coat

Depending on the condition of the old surface, a calculated amount of tack coat (Qef) of approx. 1.1 kg/m² active binder is to be sprayed evenly on the prepared surface before laying Geotextile, making sure that: -

- The bitumen is applied beyond the width of the Geotextile by about 5cm on either side.
- The spraying temperature for pure bitumen is kept between 150°C and 170°C to achieve a coating as even as possible.
- When using bitumen emulsion, the coating amount is adjusted to contain the required average amount of bitumen.
- The coating is only applied to areas where the paving felt is to be laid.
- No additional pre-spray agent is applied on top of the paving felt.
- Where only sections for the road are covered with the paving felts, their surfaces must be gritted.

16.3.14.5.3 Laying Geotextile

Geotextile shall be laid by hand or machine into account that: -

- When using pure bitumen as tack coat, Geotextile may be laid immediately after coating.

- When using bitumen emulsions, Geotextile shall not be laid until the emulsion has cured.
- Wrinkles shall be avoided.
- Edges lengthways and across overlap by 5 – 10cm, an additional pure bitumen binder of 0.9kg/m² shall be applied on the overlapping seams.
- Transverse overlapping is to be carried out with reference to the direction in which the asphalt finisher would proceed i.e. under the previous one so that the felt does not shift out of place when the asphalt concrete is applied.
- When one half of the road is made (leaving the other open to traffic), at least 25cm of the lengthways fell edge shall remain uncovered to allow overlapping when laying the other half of the road.
- During short time stoppages of construction work, the road under construction shall be opened only to slow traffic without detriment to Geotextile.
- Rain water on the Geotextile surface shall be allowed to evaporate before applying a top layer.

16.3.14.5.4 Applying the asphalt concrete surface

The asphalt concrete surfacing shall be applied immediately after laying Geotextile preferably by crawler type finisher taking, the following points into consideration.

- The material mix shall have a temperature between 145°C and 165°C.
- To avoid types of the finisher or truck sticking to the felt (which can happen in hot climates or where too much tack coat had been applied), some of the mix can be spread manually in the pathway of the vehicles.

16.3.14.5.5 Geotextile Testing

Geotextiles testing shall be in accordance with following standard test methods.

- | | |
|-------------------------------------------|---------------|
| ➤ Weight | ASTM D-3776 |
| ➤ Thickness | ISO 9863 |
| ➤ CBR Puncture Resistance test | BS 6906/4 |
| ➤ Strip Tensile Test | ASTM 0-4595 |
| ➤ Grub Tensile Test | ASTM D-1682 |
| ➤ Tear Strength Test | ASTM D-1117 |
| ➤ Penetration Resistance Test (Drop test) | NT Build 243 |
| ➤ Vertically Permeability | BS 6906/3 |
| ➤ Pore Size | E DIN 60500/6 |

Based on the required functions and the type of stresses the Contractor shall propose the type of Geotextile. The Contractor shall finish technical literature and Manufacturer's Certificate of Guarantee for the type of Geotextile material for approval of Engineer prior to delivering the material to the site. The certificate shall note compliance to the Specifications and shall state the results of the tests performed on the material, as required by the Specifications. The Contractor shall when have directed by the Engineer, have the Geotextile material tested for conformance to the applicable Specifications at an approved testing laboratory. All costs connected with certificate of Guarantee and any subsequent quality testing shall be at the Contractor's expense.

16.3.14.6 Measurement and Payment

16.3.14.6.1 Measurement

The quantities of Geotextile measured to be paid shall be the number of square meters of work completed in accordance with the requirement of this item and the limiting dimensions shall not exceed then those shown on the drawings or fixed by the Engineer. Measurement shall only be made of area covered without considering any overlap.

16.3.14.6.2 Payment

The accepted quantity measured as provided above shall be paid at the contract unit price per square meter of Geotextile laid for the pay item as listed below in the BOQ which price and payment shall constitute full compensation for furnishing all materials, labour, equipment and placing of geotextile.

Pay item Number	Description	Unit
16.3.14.6.2.1	Providing and Placing of Geotextile, Type----	SM

16.3.15 Soling Stone/Brick**16.3.15.1 Description**

This item shall consist of laying of soling stone or dry brick, hand packed on a surface (subgrade) prepared earlier and all interstices filled with sand or similar approved materials to provide proper bonding of all the stones/brick with each other.

16.3.15.2 Material Requirements

- The material for soling shall be round and durable rock, properly shaped or boulders of maximum size 15-20cm.
- Dry bricks of approved quality
- Sand for cushion in case of dry brick pavement/soling
- The filler material to provide the interstices shall be coarse sand dust or any other material approved by the Engineer In charge.

16.3.15.3 Construction Requirements

The subgrade to receive the soling stone shall be prepared under relative item of the work.

1. Placing of solid stone/brick

- The soling stone shall be placed from outer edges of the road and finishing at crown of the road in such a way that all stones are properly hand packed and keyed. With surrounding stones. At shall be ensured that the maximum dimension is kept and vertical position ensuring the variation of the size of the stone does not exceed +1" of specified thickness of soling stone.
- Half inch sand cushion should be laid before laying of dry bricks. Dry bricks shall be placed from outer edges of the road and finishing at crown of the road in such a way that all bricks are properly hand packed and keyed.

- The filler material shall be dry and in free flow condition when placed over the soling. The filler material shall be kept adding while the soling stones are rolled under a 6-tonne roller. The addition of filler material shall continue till the area does not absorb more material and it is ensured that all interstices are fully filled. The area would then be watered and kept under rolling to achieve smooth surface.

16.3.15.4 Measurement and Payment

16.3.15.4.1 Measurements

The area to be measured shall be bound by the lines shown on the drawings whereas the normal thickness shall be that which is described in BOQ. The measurement shall be made in CM.

16.3.15.4.2 Payments

The quantities determined as provided above shall be paid for at the contract unit price for cubic meter which price and payment shall be full compensation for all cost of materials, manpower and equipment's involved in the proper completion of work.

Pay item Number	Description	Unit
16.3.15.4.2.1	Laying of Soling Stone	Cubic feet
16.3.15.4.2.2	Laying of Brick Soling	Cubic feet

16.3.16 Interlocking Concrete Paving Blocks

16.3.16.1 Description

The work shall consist of precast concrete paving blocks intended for the construction of low speed roads, parking auras, lay byes, industrial and other paved surfaces subjected to all categories of static and vehicular loading and pedestrian traffic. Paving blocks, covered by these Specifications are designed to form a structural element and the surfacing of pavements, having the block to block joints filled, so as to develop frictional interlock and placed in conformity with the lines, grades, thicknesses and typical cross-section shown on the drawings or as directed by the Engineer.

16.3.16.2 Material Requirements

For execution of this item provisions made in BS EN 1338:2003 shall be applicable. Detailed requirement of materials and construction shall be as under: -

16.3.16.2.1 Binder and Binder Constituents

Paving blocks shall be made using one or more of the following binders or binder constituents complying with the requirements of relevant standards: -

- Ordinary Portland Cement BS EN 197-1:2011
- Portland Blast-furnace Cement BS EN 197-1:2011
- Portland Pulverized Fuel Ash Cement BS EN 197-1:2011
- Pulverized Fuel Ash BS EN 450-1:2012
- Ground granulated Blast furnace slag BS EN 15167-1:2006

Where pulverized fuel ash is used, the proportions and properties of the combination with Portland Cement shall comply with BS EN 197-1:2011.

Where Ground Granulated Blast Furnace slag is used, the proportions and properties of the combination with Portland Cement shall comply with BS EN 197-1:2011.

16.3.16.2.2 Aggregate

Paving blocks shall be made using one or more of the following aggregates complying with the relevant standards: -

Natural Aggregates (Crushed or Uncrushed)	BS EN 12620:2002+A1:2008
Air Cooled Blast-furnace	BS EN 12620:2002+A1:2008
Pulverized Fuel Ash	BS EN 450-1:2012
Ground Granulated Blast-furnace Slag	BS EN 15167-1:2006

16.3.16.2.3 Acid Soluble Material (Fine Aggregate)

When tested as described in BS EN 1744-1:2009+A1:2012, the fine aggregate shall contain no more than 25% by mass of acid soluble material either in the fraction retained on, or in the fraction passing, a 600 µm sieve.

16.3.16.2.4 Water

The water shall be of drinking quality or in accordance with the recommendations of appendix A of BS EN 1008:2002.

16.3.16.2.5 Admixture and Pigments

- Projectory accelerating, retarding and water reducing agents shall comply with BS EN 934-2:2009+A1:2012
- Pigments shall comply with BS EN 12878:2014.
- Calcium chloride shall comply with BS 3587: 1963.

16.3.16.2.6 Finishes

- The finish shall be agreed between manufacturer and the Engineer.
- Concrete described as "natural colour" shall contain no pigment.
- In composite paving blocks the surface layer shall be formed as an integral part of the block and shall not be less than 5mm thick

16.3.16.2.7 Binder Content

The cement content of the compacted concrete shall be not less than 380 kg/m³. For equivalent durability, paving blocks made with binder constituents other than ordinary Portland cement shall have a binder content than paving blocks made in a similar way using only Portland Cement. The Engineer would decide the additional binder content. The compressive strength test would be the only guide to the amount of additional binder needed.

16.3.16.2.8 Sizes and Tolerances

1. Size

- Paving, blocks shall have a work size thickness of not less than 60mm. Type-R blocks shall be rectangular with a work size length of 200mm and a work size width of 100 mm. Type-S blocks shall be of any shape fitting within a 295mm square coordinating space and shall have a work size width not less than 80mm.
- The preferred work size thicknesses are 60 mm, 65 mm, 80 mm & 100 mm.
- A chamfer around the wearing surface with a work size not exceeding 7mm in width or depth shall be permitted.
- All arises shall be of uniform shape.

2. Tolerance

The maximum dimensional deviations from the slated work sizes for paving blocks shall be as follows: -

- Length + 2 mm
- Width + 2 mm
- Thickness + 3 mm

Where a paving block includes profiled sides, the profiles shall not deviate from the manufacturer's Specifications by more than 2mm.

16.3.16.2.9 Compressive Strength

16.3.16.2.10 Sampling

The following sampling procedure shall be used for the compressive strength test.

- Before laying paving blocks, divide each designated section, comprising not more than 5000 blocks, in a consignment into eight approximately equal groups, clearly mark all samples at the time of sampling in such a way that the designated section or part thereof and the consignment represented by the sample are clearly defined. Take 2-blocks from each group.
- Dispatch the sample to the test laboratory, taking precautions to avoid damage to the paving blocks in transit. Each sample shall be accompanied by a certificate from the person responsible for taking the sample, stating that sampling was carried out in accordance with this Part of BS EN 1338:2003
- Protect the paving blocks from damage and contamination until they have been tested. Carry out any tests as soon as possible after the sample has been taken.

16.3.16.2.11 Marking

The following particulars relating to paving blocks made in accordance with this standard shall be indicated clearly on the delivery note invoice, manufacturer's or supplier's certificate or brochure supplied with the consignment of blocks: -

- The name, trade mark or other means of identification of the manufacturer.
- The number and date of this British Standard, i.e. BS EN 1338:2003; or latest revision.

16.3.16.3 Construction Requirements

16.3.16.3.1 Laying the concrete blocks

The total area to be covered with paving block shall be prepared by: -

- Compaction of subgrade
- Laying of sub-base in a thickness specified

Laying of crushed aggregate base or lean concrete in thickness as per typical section.

16.3.16.3.2 Tolerance

- Tolerance of these layers' shall be as per applicable requirement of each item of this Specifications.
- Payment for each of the above item shall be made under the relative item of work.
- The total area would thereby be divided with nylon strings into sectors of not more than 1.5m². This shall be done to control the alignment of paving blocks and to avoid multiplication of deviation in sizes of paving blocks.

16.3.16.4 Measurement and Payment**16.3.16.4.1 Measurements**

The area to be measured shall be done by lines shown on the drawings or as directed by the Engineer. Unit of Measurement shall be square meter measured in horizontal plane.

16.3.16.4.2 Payments

The quality determined as provided above shall be paid for the unit price of contract for each square meter of paving block installed including sand cushion and sand filling in joints and all other work related for installing paving blocks. Cost shall include all labour, materials and equipment for proper completion of work.

Pay item Number	Description	Unit
16.3.16.4.2.1	Installation of paving blocks 60 mm thick	SM
16.3.16.4.2.2	Installation of paving blocks 80 mm thick	SM
16.3.16.4.2.3	Installation of paving blocks 100 mm thick	SM

16.3.17 Brick Edging**16.3.17.1 Description**

This item shall consist of a 9-inch-wide brick on edge layer, contiguous to the pavement edge and in line with the finished profile of the base course, in combination with a 3-inch-wide brick on end course so as to make 12 inches wide brick edging. The bricks shall be laid with close joints over one-inch sand cushion and sand grouted.

16.3.17.2 Material**1. Bricks**

The size of bricks shall be as per section 1041. They shall be slightly over burnt without being vitrified. They shall be slightly over burnt without being vitrified. They shall be of uniform colour with reasonably square corners and parallel faces. They must be homogenous in texture and emit a clear ringing sound when struck. They shall be free from lime, air pockets, and marked laminations. They shall not absorb more than 1/6th of their weight of water after being soaked for one hour, and shall show no signs of efflorescence on drying. Compressive strength shall not be less than 2000 lb/sq. in. when tested in accordance AASHTO T – 32. They shall be burnt from suitable soil which shall not contain detrimental quantities of salts.

2. Sand

The sand on which the bricks are bedded and for filling the joints shall be free flowing and show no plasticity.

16.3.17.3 Construction Requirements

- Except for the top most layer of the base course, all other layers of sub base and base course shall be laid and compacted without laying edging but after completion of the consecutive layers of earthen shoulders at the same level as the pavement layer as the pavement layer to be rolled. If considered necessary, for each layer ordinary bricks may be used as form work on both sides to be removed after compacting the adjacent layers of sub base and base course.
- While laying the top most layer of the base course 9-inch-wide brick on edge layer shall be laid over 1-inch sand cushion with close joints and sand grouted. The top of these bricks after rolling shall be in line with the finished profile of the base course. The brick layer shall be rolled simultaneously with the final layer of base course after completion of the earthen shoulders.
- There in. wide brick on end course shall be laid after excavating the earthen shoulders contiguous to the 9 inches wide brick layer with top of the end course at the same level as that of the brick on edge course. The brick on end course shall be laid with close joints over 1-inch sand cushion and sand grouted.

16.3.17.4 Measurement and Payment

16.3.17.4.1 Measurements

Brick edging when laid and finished in accordance with the provisions of this section shall be measured in linear units. The Unit of measurement shall be one meter or one hundred feet of the brick edging.

16.3.17.4.2 Payments

The unit rate of brick edging shall be full compensation for provision of materials and completion of the work as specified in this section. Payment shall be made under: -

Pay item Number	Description	Unit
16.3.17.4.2.1	Brick Edging	One meter or 100 feet

16.3.18 Drainage Layer Under Shoulders

16.3.18.1 Description

The work specified in this section shall consist of providing a layer of crushed bricks, crushed stone aggregate or naturally occurring gravel of specified gradation over a prepared and well compacted subgrade over the whole shoulder width so as to provide a free drainage layer where the sub base does not cover the full width of the sub-grade the drainage layer of specified thickness shall be provided only if shown other plans and x-sections.

16.3.18.2 Material

Slightly or well over burnt crushed bricks or other crushed stone aggregate or naturally occurring gravel shall be used. The gradation shall be as follows: -

Sieve Designation	Percentage Passing by Wt. Passing Through the Mash Square Sieve.
25mm (1")	100%
19mm ($\frac{3}{4}$ ")	70-100 %
0,15mm (No. 100)	0-10%

Table 21, Gradation

16.3.18.3 Construction Requirements

A layer of drainage materials of specified thickness as described in the previous paragraph shall be laid over the well prepared and compacted sub-grade outside the sub-base to the width shown on the Plans adjoining the sub base on either side with a four percent cross slope and rolled dry with two coverages of an 8-10-ton smooth wheel roller. Over this layer, the required material for the shoulders should be spread and compacted in layers to the desired degree of compaction and conforming to remaining thickness of the sub –base and base course as shown on the plans and drawings. The drainage layer shall be provided only when shown on the Plans. The final surface shall be graded to the correct levels and cross fall and shall be within the following tolerances: -

- Under crown templet ± 12.5mm. or. +/- $\frac{1}{2}$ inch"
- Under 3 meter (10ft) straight edge +/-9.5mm or +/- $\frac{3}{8}$ inch along the road

16.3.18.4 Measurement and Payment

16.3.18.4.1 Measurements

The item of drainage layer under shoulders when completed to the actual thickness and to the clear lines shown on the plans for width and length shall be measured by superficial area. The unit of measurement will be one cubic meter or one hundred cubic feet of the completed work.

16.3.18.4.2 Rate

The unit rate shall be full compensation for furnishing and placing all materials including all labour, equipment, tools and incidentals necessary to complete the work prescribed in this Section.

16.3.18.4.3 Payments

Payment shall be made under: -

Pay item Number	Description	Unit
16.3.18.4.3.1	Crushed Brick Drainage Layer of the Specified thickness	Cubic meter / 100 cub. Ft
16.3.18.4.3.2	Crushed Stone Aggregate Drainage Layer of the specified thickness	Cubic meter / 100 cub. Ft
16.3.18.4.3.3	Gravel Drainage Layer of the specified thickness	Cubic meter / 100 cub. Ft

16.3.19 Sub Base Course-Brick Paved

16.3.19.1 Description

The work specified in this section shall consists of providing and constructing one or more layers of brick courses laid on edge or flat as called for in the Bid Schedule or shown on drawings the bricks will be laid over a sand cushion 3.28 cms (1 inch) thick and with the joints filled with sand with suitable bonding, over a prepared sub grade. Compacted up to 95% modified density in all the sections of Earthwork of these specifications

16.3.19.2 Material

1. Bricks

The size of bricks shall be as per specification. They shall be, slightly over burnt without being vitrified. They shall be of uniform color with reasonably square corners and parallel faces. They must be homogenous in texture and emit a clear ringing sound when struck. The Kiln material shall be fully burnt having reddish brown / black color. No unburnt or semi burnt material shall be allowed. The material shall behave like improved sub grade with following properties. They shall be free from lime, air pockets, and marked laminations. They shall not absorb more than 1/6th of their weight of water after being soaked for one hour, and shall show no signs of efflorescence on drying. Compressive strength shall not be less than 140 kg/cm² or 2000 lbs. / sq. in. when tested in accordance AASHTO- T 32.

They shall be molded or burnt from suitable soil which shall not contain detrimental quantities of salts.

2. Sand

The sand on which the bricks are bedded shall be free flowing and show no plasticity. And shall conform to gradation and plasticity requirements as follows: -

- Filling of joints will be filled with silty sand
- Gradation

The grading of bedding soil shall conform to the following limits.

Sieve Designation	Mass Percent Passing
1" (25 mm)	100
$\frac{3}{8}$ " (9.5 mm)	80-100
No. 10	50-85
No. 200	15-35

Table 22, Gradation

Note: - Coarser than 1" (25 mm) size material may be allowed up to five (5) percent by the Engineer.

➤ Physical Requirements

The additional physical requirements of the kiln material will satisfy the following limits: -

- P.I value. 6.0% max.
- Swelling Value. 0.20% max.
- Soaked C.B.R. (96 hours) 20% min.

16.3.19.3 Construction Requirements

1. Sub-Grade

The sub-grade shall be constructed in accordance with the 'Structural Excavation And Backfill' 'Roadway Excavation/Borrow Excavation' and 'Subgrade Preparation'.

2. Stacking of Bricks

The bricks shall be delivered at site in stacks ten courses high and two bricks thick for the convenience of proper inspection.

3. Placing of Bricks

- The prepared and compacted sub-grade as per 'Roadway Excavation/Borrow Excavation', 'Roadway Excavation/Borrow Excavation', and 'Subgrade Preparation' and shall be covered by 2.58 cm (1inch)" of sand cushion over which the bricks shall be laid closely packed in parallel rows transverse to the center line with string courses 25 ft. apart along the length and on each side, or as may be directed by the Engineer at site. The bricks shall be laid on edge or flat, in one or two courses as called for in the plans or bid schedule. If more than one course is to be laid the joints in the successive courses will be staggered. Each course shall be properly rolled and joints filled with sand before laying the next course.
- As provided in 'Bituminous Prime Coat' suitable material as provided in the bid schedule should then be placed on the shoulder and the shoulders compacted at the same time as the brick pavement is rolled.

16.3.19.4 Measurement and Payment

16.3.19.4.1 Measurements

Brick subbase course of brick pavement when laid and finished to the required thickness and grade line and accepted in place by the Engineer shall be measured by volume the quantity shall be worked by superficial area multiplied by the nominal thickness of brick layer/layers. The unit of measurement shall be cubic meter or 100 cft. one hundred cubic feet.

16.3.19.4.2 Payments

The unit rate for brick subbase course or brick pavement of specified thickness shall be full compensation for preparing and shaping the subgrade, by removing the undulation or replacement of unstable sub-grade, provision and laying of the approved sand, provision and laying of the bricks, filling the voids with sand and rolling the whole width for proper compaction

and includes material, labor, equipment, tools and incidentals necessary to complete the work prescribed in this Section.

Pay item Number	Description	Unit
16.3.19.4.2.1	Sub base course of brick laid on edge including sand cushion, 1" thick	Cubic meter or 100 cubic feet.
16.3.19.4.2.2	Brick Pavement laid flat of specified thickness including sand cushion 1" thick	Cubic meter or 100 cubic feet.

16.4 Surface Courses and Pavement

16.4.1 General

This section describes the requirements and procedures for execution of surface courses and pavements. The materials to be used shall conform to Specifications and testing procedures as per American Association of State Highway and Transportation Official (AASHTO) or the American Society for Testing and Material (ASTM) as indicated in their latest editions. Samples of materials for laboratory tests and their subsequent approvals shall be utilized according to these references unless otherwise directed by the Engineer. Materials which do not conform to the requirements of these Specifications would be rejected whether in place or not. They shall be removed immediately from the site of the work at the expense of Contractor. While subgrade/sub-base and paving operations are in progress, a detour shall be provided for vehicular flow in order to avoid any public inconvenience and thoroughly be maintained till completion of that particular section of the project or as a whole. In order to expedite the passage of public traffic through or around the work, the Contractor shall install road signs, warning lights, flares, barricades and other facilities for the safety, convenience and direction of public traffic. Also, where directed by the Engineer, the Contractor shall furnish competent flagmen whose sole duties shall consist of directing the movement of public traffic through or around the work. The cost of furnishing and installation of such road-signs, lights, flares barricades and other facilities, shall be included in the respective work item. Shall the Engineer point out the inadequacy of warning and protective measures, and require additional measures, such action on the part of the Engineer shall not relieve the Contractor from responsibility for public safety or abrogate his obligation to furnish and pay for these services.

16.4.2 Asphaltic Courses

16.4.2.1 Asphaltic Cement

- Asphalt Cement shall be an oil asphalt, or a mixture of refined liquid asphalt and refined solid asphalt. prepared from crude asphaltic petroleum. It shall be free from admixture with any residues obtained by the artificial distillation of coal, coat tar, or paraffin and shall be homogeneous and free from water. No emulsification shall occur when a 30-grain sample is boiled for 2-hours with 200cm³ or distinct water in a live 500cm³ Erlenmeyer flask equipped with a reflux condenser.
- Asphalt Cement shall be classified by penetration and when tested in accordance with the standard methods of tests of the AASHTO, the grades of asphalts shall conform to the requirements. The grade of asphalt to be used shall be in accordance with these Specifications or Special Provisions or as directed by the Engineer.

16.4.2.2 Environmental Factors

- In areas where highly frost susceptible soils and severe low temperature conditions are encountered, it may be necessary to remove and replace soils susceptible to frost heave or take other precautions prior to pavement construction. In extremely hot climates, asphalt mixes shall be designed to resist rutting and maintain stiffness at high temperatures.
- Because asphalt mixtures are influenced by temperature, it is recommended that different asphalt grades be used where different temperature conditions prevail. Table below gives recommended asphalt grades for various temperature conditions.

Temperature Condition	Asphalt Grade +
Cold, mean annual air temperature <7-degree C (45-degree F)	AC-10 AR-4000 80/100 pen
Warm, mean annual air temperature between 7 deg. C (45 deg. F) and 24 deg C (75 deg F)	AC-20 AR-8000 60/70 Pen
Hot, mean annual air temperature >24 deg C (75 deg F)	AC-40 AR-8000 40/50 Pen

Table 23, Selecting Asphalt Grade

- Both medium setting (MS) and slow setting (SS) emulsified asphalt are used in emulsified asphalt base mixes. They can be either of two types cationic (ASTM D 2397 or AASHTO M 208) or anionic (ASTM D 977 or AASHTO M 140). Selecting one of the two shall depend on the type of aggregate used for better affinity.
- The grade of emulsified asphalt is selected primarily on the basis of its ability to satisfactorily coat the aggregate. This is determined by coating and stability test (ASTM D 244, AASHTO T-59). Other factors important in the selection are the water availability at the job site, anticipated weather at the time of contraction, the mixing process to be used, and the curing rate.

16.4.2.3 Cut – Back Asphalt

- Liquid asphalt (cut hack) shall consist of materials conforming to the following classifications. When tested in accordance with the standard methods of test to the AASHTO, the grades of liquid asphalt shall conform to the requirements specified.
- Medium curing products designated by letters MC, shall consist, of asphalt cement fluxed or blended with a kerosene solvent.
- Rapid curing products designated by the letters RC, shall consist of asphalt cement with a penetration of grade 80 -100, fluxed or blended with a naphtha solvent.

16.4.2.4 Emulsified Asphalt

- Asphaltic emulsions shall be composed of a bituminous base uniformly emulsified with water and an emulsifying or stabilizing agent. They shall be classified according to use as Rapid Setting or Slow Setting, and shall conform to the requirements specified.
- The bituminous base used in manufacturing RS-1 type emulsion shall be asphalt cement, Grade 120-150 or Grade 200-300, as designated by the Engineer.
- The bituminous base used in manufacturing SS1 type emulsion shall be paving asphalt, Grade 60-70 or Grade 120-150, as designated by the Engineer.

Asphalt Type / Grade	Mixing Temp	Spraying Temperature Road Mixes
Asphalt Cement (All Grades)	As required to achieve viscosity of 75-150 secs. Saybolt-Furol or as required to achieve a kinematic viscosity of 150-300 centistokes	160(Max)
Emulsified Asphalts		
RS-1	--	--

RS-2	--	--
MS-1	10-70	20-70
MS-2	10-70	20-70
MS-2h	10-70	20-70
HFMS-1	10-70	20-70
HFMS-2	10-70	20-70
HFMS-24	10-70	20-70
SS-1	10-70	20-70
SS-1h	10-70	20-70
CRS-1	10-70	20-70
CRS-2	--	--
CMS-2	--	--
CMS-2h	10-70	10-70
CSS-1	10-70	10-70
CSS-1h	10-70	10-70
Cutback Asphalts (RC, MC, SC)		
30 (MC only)	--	--
70	--	20 min.
250	55-80	40 min.
800	75-100	55 min.
3000	80-115	--

Table 24, Application Temperature Range, °C

	40-50		60-70		80-100		120-150	
	Min	Max	Min	Max	Min	Max	Min	Max
Penetration at 77°C (25°C) 100g 5 Sec	40	50	60	70	80	100	120	150
Flash point, Cleveland Open Cup, °F (°C)	450 (232)	--	450 (232)	--	450 (232)	--	425 (218)	--
Ductility at 77°F (25 °C) 5 cm per min, cm.	100	--	100	--	100	--	100	--
Solubility in trichloroethylene percent	99	--	99	--	99	--	99	--
Thin film oven test, 1/8 in. (3.2mm), 325 °F (163 °C) 5hr Loss on heating, percent	--	0.80	--	0.80	--	1.0	--	1.3
Penetration of residue percent of original	58	--	54	--	50	--	46	--
Ductility of residue at 77 °F (25 °C) 5 cm. per min, cm	--	--	50	--	75	75	100	--

Table 25, Requirements for Asphalt Cement (AASHTO- M20)

	MC-70		MC-250		MC-800	
Water Percent	--	0.2	--	0.2	--	0.2
Flash point (tag. Open cup), Degree C	38	--	66	--	66	--
Kinematics Viscosity at 60 0C (114 °F)	70	140	250	500	800	1600
Distillation test:						
Distillate, percentage by volume of total distillate at 360 °C (680 °F)						
at 225 0C (437 °F)	0	20	0	10	--	--
at 260 °C (500 °F)	20	60	15	55	0	35
at 315 °C (600 °F)	65	90	60	87	45	80
Residue from distillation at 360 °C (680 °F) Volume percentage of sample by difference	55	--	67	--	75	--
Test on residue from distillation:						
Penetration, 100g, 5 Sec, at 25 °C (77 °F)	120	250	120	250	120	250
Ductility, 5cm/min, cm	100	--	100	--	100	--
Solubility in Trichlorethylene, percent	99	--	99	--	99	--

Table 26, Requirements for medium- Curing Type Asphalts (AASHTO M- 82)

Note1. As an alternate, Saybolt Furol viscosities may be specified as following: -

- Grade MC-70 Furol Viscosity at 50°C (122°F) - 60 to120 Sec.
- Grade MC-250 Furol Viscosity at 60°C (140°F) - 125 to 250 Sec.
- Grade MC-800 Furol Viscosity at 822°C (180°F) - 100 to 200 Sec.

Note2. If penetration of residue is more than 200 and its ductility at 25°C (77°F) is less than 100cm., the material would be acceptable it its ductility at.15.5°C (60°F) is more than 100 cm.

	RC- 70		RC- 250		RC- 800	
Water Percent	--	0.2	--	0.2	--	0.2
Flash point (tag. Open cup), Degree C	--	--	27	--	27	--

Kinematics Viscosity at 60 0C (140 0F)	70	140	250	500	800	1600
Distillation test:						
Distillate, percentage by volume of total distillate at 360 0C (680 0F)						
at 190 0C (374 0F)	10	--	--	--	--	--
at 225 0C (437 0F)	50	--	35	--	15	--
at 260 0C (500 0F)	70	--	60	--	45	--
at 315 0C (600 0F)	85	--	80	--	75	--
Residue from distillation at 360 0C (680 0f) Volume percentage of sample by difference	55	--	65	--	75	--
Test on residue from distillation:						
Penetration, 100g, 5 Sec, at 25 0C (77 0F)	80	120	80	120	80	120
Ductility, 5cm/min, of 25 0C (77 0F) cm	100	--	100	--	100	--
Solubility in Trichlorethylene, percent	99	--	99	--	99	--

Table 27, Requirements for Rapid- Curing Type Asphalts (AASHTO M- 81)

Note: As an alternate, Saybolt Furol viscosities may be specifies as following: -

- Grae MC-70 Furol viscosity at 50°C (122°F)- 60 to 120 Sec.
- Grae MC-250 Furol viscosity at 60°C (140°F)- 125 to 250 Sec.
- Grae MC-800 Furol viscosity at 82.2°C (180°F)- 100 to 200 Sec.

Type	Rapid Setting				Slow Setting			
	RS-1		RS-2		SS-1		SS-1h	
Grade	Min	Max	Min	Max	Min	Max	Min	Max
Test on Emulsions:								
Viscosity, Saybolt Furol at 77°F (25°F). Sec	20	100	--	--	20	100	20	100
Viscosity, Saybolt Furol at	--	--	75	400	--	--	--	--

122°F (50°C) Sec								
Settlement 5 days, percent (a)	--	5	--	5	--	5	--	5
Storage stability test 1 day (b)	--	1	--	1	--	1	--	1
Demulsibility. 35 ml. 0.02 NCaCl ₂ percent	60	--	60	--	--	--	--	--
Cement mixing test, percent	--	--	--	--	--	2.0	--	2.0
Sieve test. percent	--	0.10	--	0.10	--	0.10	--	0.10
Residue by distillation, percent	55	--	63	--	57	--	57	--
Test on Residue from Distillation Test Penetration, 77 °F (25°C) 100g. 5 Sec.	100	200	100	200	100	200	40	90
Ductility, 77°F (25°C), 5 cm/min. cm	40	--	40	--	40	--	40	--
Solubility in trichloroethylene, percent	97.5	--	97.5	--	97.5	--	97.5	--
Suggested Uses	Surface Treatment penetration macadam and tack coat		Surface Treatment penetration macadam		Plant or road mixture with graded and fine aggregates, a substantial quantity of which passes a No. 8 (2.3mm) sieve and a portion of which may pass a No. 200 (0.075 mm) sieve; slurry seal treatments.			

Table 28, Requirements for Emulsified Asphalts (AASHTO M- 140)

- The test requirement for settlement may be waived when the emulsified asphalt is used in less than 5 days' time; or the Engineer may require that the settlement test be run from the time the sample is received until it is used, if the elapsed time is less than 5 days.
- The 24-hr. (1 day) storage stability test may be used instead of the 5 days settlement test.
- The demulsibility test shall be made within 30 days from date of shipment.

16.4.3 Bituminous Prime Coat

16.4.3.1 Description

This work shall consist of furnishing all plant, labour, equipment, material and performing all operations in applying a liquid asphalt prime coat on a previously prepared and untreated; earth subgrade, water bound base course, crushed aggregate base course, tops of roadway shoulders, and as otherwise shown on the, plans in strict accordance with the Specifications and in conformity with the lines shown on the drawings.

16.4.3.2 Material Requirement

Asphaltic material shall conform to the requirements of the "Asphaltic Materials", either cutback or Emulsified Asphalt, whichever is specified in the BOQs.

16.4.3.2.1 Blotter Material

Generally, a prime coat should be touch dry within 2 to 4 hours and completely dry in 24 to 48 hours. If it is necessary to use blotter materials because the section has to be opened to traffic or for other reasons, the blotter material shall be clean and dry sand passing 4.75 mm (No. 4) sieve.

16.4.3.3 Construction Requirements

Prime coat shall be applied when the surface to be treated is dry; except that when emulsified asphalt is used, the surface may be reasonably moist. The application is prohibited when the weather is foggy or rainy, or when the atmospheric temperature is below 15°C unless otherwise directed by the Engineer. Prior to the application of the prime coat, all loose materials shall be removed from the surface and the same shall be cleaned by means of approved mechanical sweepers or blowers and/or hand brooms, until it is as free from dust as is deemed practicable. No traffic shall be permitted on the surface after it has been prepared to receive the bituminous material. Prior to the application or prime coat on bridge decks and concrete pavements the surfaces shall be cleaned of all loose material. All expansion joints shall be cleaned and filled with bituminous material as directed by the Engineer. Areas to be primed would be classified as under: -

- The top of earth surface or water bound base courses from a point twenty 20cm outside the edge of the pavement line to 20cm outside the line on the opposite side of the roadway.
- The top or the shoulders from the inter-section of embankment slope and top of subgrade to the edge of the pavement line.
- The bridge wearing surface from curb to curb and end to end of bridge wearing surface.
- Other surfaces as shown on the plans or ordered by the Engineer.

Printed surface shall be kept undisturbed for at least 24 hours, so that the bituminous material travels beneath and leaves the top sulfate in non-tacky condition. No asphaltic operations shall start on a tacky condition.

16.4.3.3.1 Equipment

The liquid asphaltic material shall be sprayed by means of a pressure distributor of not less than 1000-liter capacity, mounted on pneumatic tires of such width and number that the load produced on the road surface would not exceed 100kg/cm of tire. It shall be of recognized manufacturer.

The tank shall have a heating device able to heat a complete charge of asphaltic liquid up to 180°C. The heating device shall be so that overheating would not occur. Consequently, the flames must not touch directly on the casting of the tank containing the asphaltic liquid or gases therefrom. The Contractor would be responsible for any fire or accident resulting from heating of bituminous materials. The liquid shall be circulated or stirred during the heating. The tank shall be insulated in such a way that the drop-in temperature when the tank is filled and not

heated would be less than 2°C/hr. A thermometer shall be fixed to the tank in order to be able to control continuously the temperature of the liquid. The thermometer shall be placed in such a way that the highest temperature in the tank is measured. The tank shall be furnished with a device that indicates the contents. The pipe for filling the tank shall be furnished with an easily interchangeable filter.

The distributor shall be able to vary the spray width of the asphaltic liquid in steps of maximum 10cm, to a total width of 4m. The spraying bonbon have nozzles from which the liquid is sprayed fan-shaped on the road surface equally distributed over the total spraying width.

The distributor shall have a Pump for spraying the liquid driven by a separate motor, or the speed of the pump shall be synchronized with the speed of the distributor. The pump shall be furnished with an indicator showing the performance in liters/minute. At the suction side the pump shall have a filter easily exchangeable thermometer shall be fixed, which indicates temperature of the liquid immediately before it leaves the spraying bar.

The distributor shall be furnished with a tachometer indicating the speed in. m/minute. The tachometer shall be visible from the driver's seat; The function of the distributor shall be so exact that the deviation from the prescribed quantity to be spread on any square meter does not exceed 10%. The distributor shall be equipped with a device for hand spraying of the bituminous liquid, to cover any irregular area or covering Me area improperly sprayed.

16.4.3.3.2 Application of Asphaltic Material

Immediately before applying prime coat, the full area of surface to be treated shall be swept with a power broom to remove all dirt and other objectionable material. If required by the Engineer, the surface shall be made moist but not saturated. Asphaltic Materials shall be applied at temperature specified by approved pressure distributors operated by skilled workmen. The spray nozzles and spray bars shall be adjusted and frequently checked so as to ensure uniform distribution. Spraying shall cease immediately upon any clogging or interference of any nozzle and remedial taken before spraying is resumed.

The rate for application of asphaltic material (cut back/emulsified) shall be as under: -

Types of Surface	Liters Per Square Meter	
	Minimum	Maximum
Subgrade, Sub-base Water bound base courses, and Crushed stone base course.	0.65	1.75
Bridge, Wearing Surfaces, Concrete Pavement	0.15	0.4

Table 29, Rate for Application of Asphaltic Material

However, the exact rate shall be specified by the Engineer determined from filed trials.

The test methods shall be determined by the Engineer and performed by the Contractor in the presence of Engineer.

The prime coat shall be left undisturbed for a period of at least 24 hours, and shall not be opened to traffic until it has penetrated and cured sufficiently so that it would not be picked up by the wheels of passing vehicles. The Contractor shall maintain the prime coat until the next course is applied. Care shall be taken that the application of bituminous material is not in excess of the specified amounts; any excess shall be blotted with sand or similar treatment.

All areas inaccessible to the distributor shall be sprayed manually using the device for hand spraying from the distributor.

The surface or structures and trees adjacent to the area being treated shall be protected in such manner as to prevent their being spattered or marred.

Where no convenient detour is available for traffic, operations shall be confined to one-half the roadway width at a time. The Contractor shall provide proper traffic control so that vehicles may proceed without damage to the primed area. Work shall not be started on the portion of the road not covered by previous application until the surface previously covered has dried and is ready for traffic.

16.4.3.3 Maintenance of opening of Traffic

The prime coat shall be left undisturbed for a period of at least 24 hours, and shall not be opened to traffic until it has penetrated and cured sufficiently so that it will not be picked up by the wheels of passing vehicles. The Contractor shall maintain the prime coat until the next course is applied. Care shall be taken that the application of bituminous material is not in excess of the specified amounts; any excess shall be blotted with sand or similar treatment. All areas inaccessible to the distributor shall be sprayed manually using the device for hand spraying from the distributor. The surface of structures and trees adjacent to the area being treated shall be protected in such manner as to prevent their being spattered or marred. Where no convenient detour is available for traffic, operations shall be confined to ½ the roadway width at a time. The Contractor shall provide proper traffic control so that vehicles may proceed without damage to the primed area. Work shall not be started on the portion of the road not covered by previous application until the surface previously covered has dried and is ready for traffic.

16.4.3.4 Measurement and Payment

16.4.3.4.1 Measurement

The unit of Measurement shall be square meter as actually covered by prime coat in accordance with these Specifications. No Measurement or payment would be for the areas primed outside the limits, specified, herein, shown on the plans of designed by the Engineer.

16.4.3.4.2 Payment

The payment for area primed measured as stated above, shall be made for the unit price per m², or 100 sft. Which payment shall be full compensation for furnishing all labor, material, tools, equipment and incidentals and for performing all the work involved in applying prime coat, complete in place in accordance with these specifications: -

Pay Item No	Description	Unit
16.4.3.4.2.1	Bituminous Prime Coat.	m ² or 100 sqf.

16.4.4 Bituminous Tack Coat

16.4.4.1 Description

The work covered by this section shall consist in furnishing all plant, labour, equipment and applying asphaltic material on a previously prepared asphaltic layer, in addition to performing all operations in connection with the application of a Bituminous tack coat, complete in accordance with these Specifications and to the width shown on the typical cross-sections of applicable drawings.

16.4.4.2 Material Requirements

Asphaltic material shall conform to the requirement of "Asphaltic Materials" for emulsified asphalt, or cut hack asphalt as called for in the Bill of Quantities.

16.4.4.3 Construction Requirements

16.4.4.3.1 Weather Condition

The tack coat shall be applied only when the surface is dry, however for emulsified asphalt, application may be made on a reasonable moist surface. Application of tack coat shall be avoided in case of foggy or rainy weather. Prior to the application, an inspection of the prepared surface would be made by the Engineer to determine its fitness to receive the Bituminous binder and no tack coat would be applied until the surface has been approved.

16.4.4.3.2 Cleaning of Surface

Immediately before applying the tack coat, all loose material, dirt and other objectionable material, shall be removed from the surface to be treated by power brooms and/or blowers, supplemented with hand brooms, as directed by the Engineer.

16.4.4.3.3 Equipment

Equipment shall conform in all respect to the provision under specified item and shall be subject to the approval of the Engineer in addition to the maintenance of the same in a satisfactory working condition at all times. A hand power spray attachment to a bitumen pressure distributor or other container having an independently operated bitumen pump, pressure gauge, thermometer for determining the temperature of the asphalt tank contents and a hose connected to a hand power spray suitable for applying the Bituminous tack coat in the amounts specified - all to be such as to meet the approval of the Engineer, shall be furnished.

16.4.4.3.4 Application of Asphaltic Material

- Asphaltic material shall be applied by means of a pressure distributor at the temperature stated in Section 16.4 'Surface Courses And. Pavement' under heading 'Asphaltic Materials' for the particular material being used. Rates of application of cut back shall be within the range of 0.2 - 0.4 liters/m² and for emulsified asphalt the rate shall be within the range of 0.3 - 0.6 per m²; the exact rate shall be specified by the Engineer.
- Care shall be taken that the application of asphaltic material is not in excess of the specified quantity; any excess asphalt shall be blotted by sand or similar treatment. All areas inaccessible to the distributor shall be treated manually using the device for hand spraying from the distributor. The surfaces of structures and trees adjacent to the areas

being treated shall be protected in such a manner as to prevent their being sputtered or marred.

- Where no convenient detour is available for traffic, operations shall be confined to one-half the roadway width at a time. The Contractor shall provide proper traffic control so that vehicles may proceed without damage to the treated area. Work shall not be started on the portion of the road not covered by previous application until the surface previously covered has dried and is ready for paving.
- Traffic shall be kept off the tack coat at all times. The tack coat shall be sprayed only so far in advance of the surface course as would permit it to dry to a "tacky" condition. The Contractor shall maintain the tack coat until the next course has been placed. Any area that has become fouled, by traffic or otherwise, shall be cleaned by Contractor at his own cost before the next course is applied.

16.4.4.4 Measurement and Payment

16.4.4.4.1 Measurement

The quantities of Bituminous Tack Coat shall be measured in square meter for the actual area Tacked with asphaltic material on the prepared surface in accordance with this Specifications.

16.4.4.4.2 Payment

The payment of bituminous Tack coat, measured as stated above shall be paid for at the unit price per square meter, or 100 sft. Which payment shall be full compensation for furnishing all labor, materials, tools, equipment and incidentals and for performing all the work involved in applying Tack Coat complete in place, as shown on the Drawings and in accordance with these specifications.

Pay Item No	Description	Unit
16.4.4.4.2.1	Bituminous Tack Coat.	m ² or 100 sft.

16.4.5 Bituminous Surface Treatment and Surface Dressing (Seal Coat / Pad Coat)

16.4.5.1 Description

This work shall consist of one or more applications of asphaltic material and one or more pavers of aggregates or an application of asphaltic material without aggregates applied in accordance with these Specifications and in conformity with lines and width shown on the typical cross-sections or as established by the Engineer.

16.4.5.2 Materials

16.4.5.2.1 Bituminous Binders

Bituminous binders will be of the type and grade as specified taking into consideration climatic conditions and the intensity of traffic, and will be in accordance with the requirements of the quantities of bituminous binders recommended are for penetration grade asphalts. The quantities of cutbacks and emulsified asphalts shall be based on the amount of asphalt residue or as directed by the Engineer.

16.4.5.2.2 Aggregate

The aggregate shall be of the specified nominal size in conformity with the grading and shape given in tables below. Crushed gravel or crushed stone shall consist of clean, tough, durable fragments, free from dirt or other deleterious substances and shall not have a percentage of Los Angeles wear greater than 35% at 500 revolutions as determined by AASHTO T-96. The quantities of aggregates recommended in Table given below are for Triple Surface Treatment and Surface Dressing/resurfacing respectively.

Surface Treatment		Nominal Size		Rate of Spreading of Aggregate		Rate of Application of Bitumen	
Type	Application	Standard	Alternate	Cubic meter /100 sq meter	Cubic feet per /100 sq. ft	Kilogram (kg)/100 sq meter	Pounds (lbs)/ 100 sq. Feet
Triple (Heavy)	1st Coat	25.00 mm	1"	1.68	5.50	1.95	40
Heavy (Listed)	2nd Coat	12.50 mm	½"	0.84	2.75	122	25
	3rd Coat	06.30 mm	¼"	0.46	1.50	68	14
Total for three Coats				2.98	9.75	385	79
Triple	1st Coat	19 mm	¾"	1.22	4	171	35
Light	2nd Coat	9.5 mm	3/8"	0.61	2	88	18
	3rd Coat	6.30 mm	¼ "	0.46	1.50	68	14
Total for Three Coats				2.29	7.50	327	67

Table 30, Quantities of Material (Binder and Aggregate) for Surface Treatment

Surface treatment		Nominal size		Rate of spreading of Aggregate		Rate of application of Bitumen	
Type	Application	Standard	Alternate	Cubic meter /100 sq meter	Cubic feet per /100 sq Feet.	Kilogram (kg)/100 sq meter	Pounds (lbs)/ 100 sq. Feet
Resurfacing (Heavy)	Single coat	19.00 mm	¾"	1.06	3.5	107	22
Resurfacing (Light)	Single coat	12.50 mm	½"	0.67	2.50	98	20

Table 31, Quantities of Material (Binder and Aggregate) for Surface Treatment

Nominal Size	Specified Size			Over Size			Under Size			Maximum permissible Flakiness index (BS-812)
	Passing Sieve	Retained Sieve	Minimum proportion of specified size percent	All to pass sieve	Max of nominal size retaining on sieve percent	Passing sieve	Max of nominal size retaining on sieve percent	Passing sieve	Maximum Fine Percent	
25.0 mm (1")	25.0 mm (1")	19.0mm (3/4")	60	37.5 mm (1-1/2")	15	12.5 mm (1/2")	7	2.38 mm (No.8)	2	35
19.0 mm (3/4")	19.0 mm (3/4")	12.5 mm (1/2")	65	25.0mm (1")	15	9.5 mm (3/8")	7	2.38 mm (No.8)	2	35
12.5mm (1/2")	12.5mm (1/2")	9.5mm (3/8")	55	19.0mm (3/4")	15	6.3 mm (1/4")	7	2.38 mm (No.8)	2	35
9.5mm (3/8")	9.5mm (3/8")	6.3 mm (1/4")	60	12.5mm (1/2")	15	4.75 (mm) (No.4)	10	2.38 mm (No.8)	2	35
6.3 mm (1/4")	6.3 mm (1/4")	3.3mm (1/8")	70	09.5mm (3/8")	15	02.38 mm (No.8)	10	0.60 mm (No.8)	2	35

Table 32, Grading Specifications for Single Size Chipping

Nominal Size	Sieve Size									Maximum Permissible flakiness index (BS-812)
	37.5 mm 1-1/2"	25mm 1"	19mm 1/2"	12.5mm 1/2"	9.5mm 3/8"	6.3mm 1/4"	4.75mm No. 4	2.38mm No. 8	0.075 mm No. 200	
Percentage Passing by Weight										
25 mm (1")	100	85-100	0-40	0-7	-	-	0-1	-	0-0.5	35
19 mm (3/4")	-	100	95-100	0-20	0-5	-	-	-	0-05	35

12.5mm (1/2")	-	-	100	95-100	0-30	0-5	-	-	0-0.5	35
9.5 mm (3/8")	-	-	-	100	95-100	0-40	0-5	-	0-0.5	35
6.3 mm (1/4")	-	-	-	-	100	85-100	0-30	0-10	0-0.5	35
4.75mm (No.4)	-	-	-	-	-	100	95-100	0-40	0-0.5	35

Table 33, Alternate Grading (Single Size Chipping)

16.4.5.2.3 Asphaltic Material

The asphaltic material shall conform to the requirements of "Asphaltic Materials". The type shall be one of the following as shown in the BOQs or ordered by the Engineer. Spraying temperature shall be as shown against each type.

Asphalt Type /Grade	Spraying Temperature
Asphalt Cement	
AC- 2.5	130 min
AC- 5	140 min
AC-10	140 min
AC-20	145 min
AC-40	150 min
AR-1000	155 min
AR-2000	140 min
AR-4000	145 min
AR-8000	145
AR-16000	--
200-300 pen	130 min
120-150 pen	130 min
85-100 pen	140 min
60-70 pen	145 min
40-50 pen	150 min
Emulsion Asphalts	
RS-1	20-60
RS-2	50-85
MS-1	20-70
MS-2h	--
HFMS-1	--
HFMS-2	20-70
HFMS-2h	--
HFMS-2s	--
SS-1	--
SS-1h	--
CRS-1	50-85
CRS-2	50-85
CMS-2	--
CMS-2h	--
CSS-1	--
CSS-1h	--
Cutback Asphalts (RC, MC, SC)	
30 (MC only)	30 min
70	50 min
250	75 min
800	95 min
3000	110 min

Table 34, Spraying Temperatures (°C) for Surface Treatments

16.4.5.3 Constriction Requirements

At the time of the application, the weather shall be warm and dry, and the road surface shall be clean and dry. Spraying shall not be done unless the road temperature is above 20°C for

at least one hour prior to the commencement of spraying operation, and the temperature shall not be less than 20°C during the spraying. Prior to applying the asphaltic material, dirt and other objectionable materials shall be removed from the surface and surface shall be primed as specified if so, directed by the Engineer, the surface shall be cleaned by power brooming or wire brush until all loose and foreign materials are removed.

16.4.5.3.1 Equipment

Equipment shall conform in all respects to the provisions under Section 'Bituminous Prime Coat' under heading 'Construction Requirement - sub-bending 'Equipment's'. The equipment shall be operated by the manpower specially trained for this work. Necessary safety arrangement for the workers, equipment and traffic shall be ensured during the operations.

16.4.5.3.2 Preparation of Surface

- Irregularities and surface damage e.g. pot-holes, depressions, raveling shall be corrected prior to surface dressing. The Engineer shall also satisfy himself that fundamental pavement defects e.g. base failure, drainage problems etc. have been remedied before dressing is attempted. Areas, which are excessively rich in bitumen e.g. 'bleeding', shall be cut out compacted, sealed and blinded with crusher dust before opening to traffic for several days before surface dressing commences.
- Immediately prior to the application of binder all dirt, dust and foreign material shall be removed by thorough brooming and/or the use of compressed air. Adhering mud or other soiling may be removed using water and brushes, the general use of water to wash the road shall not be permitted.

16.4.5.3.3 Application of Asphaltic Materials

- Asphalt cement, liquid asphalt and emulsified asphalt shall be applied by means of pressure distributor manual or automatic at the temperature specified for the type and grade of asphalt being used. The rates of application shall be within the ranges given in the Table.
- The spread of bituminous materials shall be at least 10cm more than the width to be covered by the aggregate from the spreading device. The distributor shall be moving forward at proper application speed at the time the spray bar is opened. Any skipped areas or deficiencies shall be corrected in an approved manner. Junctions or spreads shall be carefully made to assure a smooth riding surface. The length of spread of bituminous material shall not exceed that which trucks loaded with cover coat material can immediately cover. Under no circumstances shall operations proceed in such manner that bituminous material would be allowed to chill, set up, dry, or otherwise impair retention of the cover coat.
- The distributor when not spreading shall be so designed that the spray bar or mechanism would not drip bituminous material on the surface of the traveled way: Distribution of the bituminous material shall be so regulated and sufficient bituminous material left in the distributor at the end of each application, so that there would be a uniform distribution of bituminous material. In no case shall the distributor be allowed to expel air with the bituminous material thereby causing uneven coverage. The angle of the spray nozzles and the height of the spray bar shall be so adjusted and frequently checked that uniform distribution is ensured. The distribution shall cease immediately upon any clogging or interference of any nozzle and corrective measures shall be taken before distribution is resumed.

16.4.5.3.4 Spreading of Aggregate

- Immediately after applying the asphaltic material, dry aggregate shall be uniformly and evenly distributed over the treated surface from an approved mechanical aggregate spreader or any other means approved by the Engineer. The truck carrying the aggregate shall move backward as it spreads same, so as to prevent the tyres of the truck and the mechanical aggregate spreader from driving directly on the newly sprayed asphalt. No portion of the binder shall remain uncovered for a period in excess of 20 minutes' oiler spraying.
- Immediately after spreading of the aggregate, the treated surface shall be rolled with a self-propelled pneumatic-tyre roller having a minimum contact pressure of 2.8 kg/cm². A steel-wheeled roller weighing between 6 to 8 tons may be used as a second roller. Rolling shall continue only until a smooth, thoroughly compacted surface is obtained. Procedures of starting, stopping, or turning of any piece of equipment which results in displacement of the cover material or damage to the seal courses be prohibited.
- Any place where binder shows on the surface shall be covered with additional aggregate and further rolled and broom dragged until an even surface result, and does not adhere to wheels of vehicles. Overlapping the applications of cover material shall be avoided and all spillage shall be removed from the surface.
- The quantity of aggregates to be applied shall be within the ranges specified in the Table above.

16.4.5.3.5 Maintenance of Traffic

- Detouring of highway for this work on running road would not be provided for or permitted, except when authorized by the Engineer.
- All construction operations shall be coordinated to result in the least predictable delay of traffic. One-way traffic shall be maintained and traffic speeds restricted to 15km/hour.
- The Contractor shall provide flagmen, warning signs, barricades, and a sufficient number of pilot cars to control traffic through the bituminous sealing operations when so directed by the Engineer.
- Pilot cars shall be used to lead the traffic through the areas of all distribution and sealing operations. Pilot cars shall be light "Pick up" trucks or other approved vehicles and shall be equipped with signs reading "Pilot Car Do Not Pass" in both English and Urdu languages.
- 2-signs shall be mounted on the vehicles so as to be clearly visible from both directions. 1-flagman shall be stationed immediately ahead of the application of the bituminous material and 1-flagman immediately behind the section being rolled.
- Suitable speed limit signs shall be displayed, and the signs shall move forward with the flagman as the work progresses.
- No separate payment shall be made for conformance to this paragraph. All these items being considered subsidiary to the item (s) given in the Bill of Quantities.

16.4.5.3.6 Working of Period

All work shall be so conducted that the work of applying asphalt and aggregate and of all rolling shall be completed during the time from sunrise to sunset and under favorable weather conditions as determined by the Engineer.

16.4.5.3.7 Maintenance of Completed Work

When directed by the Engineer, the Contractor would be required to add bituminous material or aggregate or both to the portion of road identified for such purpose on the project. Furnishing additional bituminous material and furnishing, spreading, dragging and rolling of additional aggregate would not be paid for separately but would be considered as subsidiary work pertaining to the relevant item of 'Bituminous Surface Treatment'.

16.4.5.3.8 Opening to Traffic and after care

There shall be no delay in opening a completed surface dressing to traffic at a controlled speed. Prior to opening to traffic any spillage of aggregates shall be removed and any binder drips or windblown contamination shall be dusted with crusher waste. After 2-3 days under traffic, excess stone would be removed by brushing.

16.4.5.3.9 Pad Coat

To ensure chipping retention when surface dressing a very hard surface, a pad coat consisting of application of an initial binder spray followed by 6mm chipping would be applied. After stabilizing of pad coat under traffic, the appropriate surface dressing would be applied.

16.4.5.4 Measurement and Payment**16.4.5.4.1 Measurement**

The quantity of surface treatment to be paid for shall be measured in square meter within the theoretical line in place as shown on drawing. No allowance would be given for material placed outside the theoretical limits of finished surfacing whether placed for, due to requirement of Contractor's operations or placed outside the limits due to inadequate control.

16.4.5.4.2 Payment

The unit rate shall be full compensation for furnishing and applying bituminous material and aggregate in the specified quantities including all labour, materials, equipment, tools and incidentals to complete the work prescribed in this section. When called for in the bid schedule, the unit rate for stockpiling of aggregate of the specified size (s) shall be full compensation for procurement, supply and stacking of specified quantity of aggregate. Separate rates shall be quoted by the Contractor for aggregates required for each coat of surface treatment and surface dressing. Payment shall be made as under: -

Pay Item No	Description	Unit
16-10-a, b, c	Single, Double & Triple Surface Treatment using the specified quantities of Bitumen and Aggregate	Square feet
16-11-a, b	Surface Dressing (Re-surfacing) using the specified quantities of Bitumen and Aggregate	
	i) Surface Treatment Heavy	Per sq.m or per 100 sft
	ii) Surface Treatment Light	Per sq.m or per 100 sft

16.4.5.4.2.3	Supplying aggregate of specified size for triple surface i. For Heavy Treatment ii. For Light Treatment	Per cubic meter (m ³) or per 100 cubic feet (ft ³) Per cubic meter (m ³) or per 100 cubic feet (ft ³)
16.4.5.4.2.4	Supplying aggregate of specified sizes for Resurfacing i. For Heavy Treatment ii. For Light Treatment	Per cubic meter (m ³) or per 100 cubic feet (ft ³)

16.4.6 Semi Grout Surfacing

16.4.6.1 Description

This work shall consist of furnishing and placing three courses of graded aggregate and two applications of bituminous binders, with a bituminous seal coat and chip covering, constructed on a prepared surface, by the penetration method, in accordance with these specifications in reasonably close conformity with the lines, grades thickness and typical cross sections shown on the plans or established by the Engineer. The Specification of this section are applicable if the item exists the bid schedule.

16.4.6.2 Materials

1. Bitumen

The type of bituminous material will be specified in the contract and the grade designated by the Engineer.

2. Aggregate

Aggregate shall consist of crushed clean, hard, tough and durable fragments of stone or gravel, free from soft and disintegrated pieces, organic impurities and other injurious material. Coarse aggregate shall be free from an excess of flat or elongated pieces. The flakiness index shall not exceed 35 percent. Screenings to fill the voids in the coarse aggregate shall be of crushed stone, quarry waste or any other suitable material having same cementing properties as per gradation in table given below.

3. Gradations

Gradation of coarse aggregate (essentially single sized), key aggregate and cover aggregate shall conform to the requirements of Table Aggregate Gradation. The nominal size of the coarse aggregate shall not be less than one half or more than 3/4 of the thickness of layer. Quantities of materials shall be in accordance with Table – (Quantities of Material for 50 mm or 2" thick semi grout surfacing).

	Percent Passing by Weight					
	Coarse Aggregate		Key Aggregate	Cover Aggregate	Seal Aggregate	Screening
	No (1)	No (2)				
75 mm	100					
63mm	90-100	100				
50mm		90-100				
38mm	15-35					
25mm	0-10	15-35	100			

19mm		0-10	55-100	100		
12.5mm			0-15	90-100	100	
9.5mm			--	--	85-100	100
4.75mm			0-2	10-30	10-40	80-100
2.38mm				0-3		--
0.15mm						10-30

Table 35, Aggregate Gradation

Quantity of Materials Per Sq. M					
	Bitumen kgs.	Coarse Aggregate Cu. m.	Key Aggregate Cu. m.	Cover Aggregate Cu. m.	Seal Aggregate Cu. m.
First Application	--	--	0.06	--	--
First Application	2.44	--	--	--	--
Second Spreading	--	--	0.005	--	--
Second Application	0.32	--	--	--	--
Third Spreading	--	--	--	0.0028	--
Third Application	0.18	--	--	--	--
Seal Spreading	--	--	--	--	0.0012

Table 36, Quantities of Materials for 50mm Thick Grout Surfacing

Note: The quantities of first spreading of aggregate and the first application of bitumen may be proportionately increased depending upon the thickness of the course. There will be no change in the subsequent operations.

16.4.6.3 Construction Requirements

1. Weather Limitations

Semi grout surfacing shall not be done on any wet surface, when the air temperature is below 15-degree (60 °F) C or when weather conditions otherwise would prevent the proper construction of the pavement.

Note: Dates may be established by the Engineer between which no bituminous layer shall be placed except with written approval.

2. Equipment

The equipment to be used shall include a power broom (hand brooms may be used if sufficient labour is available), or a power blower, (8 – 12 ton) rollers, spreader as may be approved by the Engineer for spreading coarse aggregates, a bituminous binder distributor, and equipment for heating bituminous material.

16.4.6.4 Construction Methodology

1. Placing and Compacting Coarse Aggregate capital

Immediately before placing coarse aggregates the surface upon which the pavement is to be constructed, a layer of screenings @ 0.018 cu. Meter per square meter or 6 cub ft / 100 sft. shall be placed in a uniform thickness. Coarse aggregate shall be placed in the required amount by approved stone spreaders, or by other approved methods. All areas of non – uniformly graded aggregate shall be removed and replaced with suitable material before the rolling begins. These corrections shall be made by hand picking whenever necessary and shall be continued after initial rolling until the appearance and texture of the aggregate are uniform and all irregularities are corrected. The coarse aggregate shall be dry rolled until the aggregate does not creep or wave ahead of the roller. Rolling shall be parallel to the road center line and shall start at the outer edges of the road, overlap equal portions of aggregate and shoulder and progress toward the center, overlapping on successive passes by at least one – half the width of the roller except that on super – elevated curves rolling shall progress from the lower to the upper edge. Finally, sufficient water shall be added to make slurry with the screening under the roller and rolling continued till the surface is even and firm. Material which crushes under the roller or becomes segregated in such manner as to prevent free and uniform penetration of the bituminous material shall be removed and replaced with the suitable aggregate. Any irregularities in the surface profile shall be made good by raking or filling. Along curbs, headers, and walls, and at all places not accessible to the roller, the aggregate shall be tamped thoroughly with mechanical tampers or with hand tampers. Each hand tamper shall weigh not less than 13.60 kg, and have a face area of not more than 650 square cm. Aggregate in any course that becomes coated or mixed with dirt or clay prior to the application of the bituminous material shall be removed and replaced with clean aggregate, and the area shall be rerolled. Any dust or vegetable matter shall completely be removed and the slurry within 9.5mm-25mm of the surface shall be cleaned and removed by coir brushes. Prior to application of the bituminous material, the surface of the aggregate will be tested by the Engineer using a 3.048 m straight edge at selected location. The variation of the surface from the testing edge of the straight edge between any two contacts with the surface shall at no point exceed 4.75mm. All humps or depression exceeding the specified tolerance shall be corrected by removing defective work and replacing it with new material as specified.

2. Application of Bituminous Materials

Bituminous material shall be uniformly applied by distributor at the rate specified. The bituminous binder shall be heated at the specified temperature for the grade of the bitumen used. Successive spray widths shall be overlapped by an amount sufficient to give a uniform rate of spread over the joint. During the application of bituminous material care shall be taken to prevent spattering adjacent pavement, structures and trees. The distributor shall not be cleaned or discharged into ditches, borrow pits or the shoulders or along the right of way.

3. Application of Key Aggregate

Immediately following the first application of bituminous material, key or choke aggregate shall be spread and worked into the voids of the coarse aggregate by broom dragging and rolling. Additional key aggregate shall be spread as required, broom dragged and rolled until the course is uniformly filled and compacted. If the layer of penetration is more than 75mm compacted the process outlined above in sub section 3.3 to 3.5 shall be repeated for successive layers.

4. Cover and Seal Coat

Before a cover and a seal coat is applied the loose stone, the surface shall be brushed off, and the surface sprayed with the quantity of bitumen specified. The cover aggregate of the size specified shall be spread within 15 minutes of applying the bitumen and rolled with a steel tyred roller or pneumatic tyred roller. Rolling shall not be continued if the aggregate shows

excessive crushing. The surface may be opened to traffic after this treatment if no rain is anticipated for unto 3 months or otherwise the seal coat shall be provided at the earliest.

5. Seal Coat

Seal coat forms an essential part of semi grout surface course which should not be delayed for more than 6 months and in any case should be provided before the first rainy season. Before applying the final seal coat, all loose chipping or foreign matter shall be removed with brooms or flowers. The bitumen specified shall then be sprayed at the specified rate of spread and covered with seal aggregate within 15 minutes. The surface shall be rolled and surplus aggregate removed after 7 days.

6. Stockpiling

Stockpiling of aggregate shall be carried at points specified on the plans or approved by the Engineer in accordance with specifications of course aggregate for concrete.

16.4.6.5 Measurement and Payment

1. Measurement

Semi grout surfacing of specified thickness shall be measured by superficial area. The unit of measurement shall be square meter or 100 sq. Ft.

2. Payment

The unit rate shall be full compensation for furnishing and applying the bituminous material and aggregates in the specified quantities (in all the 3 courses), including all materials, labour, equipment, tools and incidentals necessary to complete the work prescribed in this Section. Payment shall be made under: -

Pay Item No	Description	Unit
16.4.6.5.2	Semi- Grout Surfacing of specified thickness.	m ² or 100 sft.

16.4.7 Penetration Macadam

16.4.7.1 Description

This work shall consist of furnishing and placing one or more courses of graded aggregate and one or more applications of bituminous binders, with a bituminous seal coat and chip covering, constructed on a prepared surface, by the penetration method, in accordance with these specifications in reasonably close conformity with the lines, grades, thickness and typical cross sections shown on the Plans or established by the Engineer. The specifications of this section are applicable only if the item exists in the bid schedule

16.4.7.2 Materials

1. Bitumen

The type of bituminous material will be specified in the contract and the grade designated by the Engineer. The bituminous material furnished shall meet the requirements.

2. Aggregate

Aggregate shall consist of crushed clean, hard, tough and durable fragments of stone or gravel, free from soft and disintegrated pieces, organic impurities and other injurious material. Coarse aggregate shall be free from an excess of flat or elongated pieces. The flakiness index shall not exceed 35 percent.

3. Gradations

Gradation of coarse aggregate (essentially single sized), key aggregate and cover aggregate shall conform to the requirements of Table Aggregate Gradation. The nominal size of the coarse aggregate shall not be less than one half or more than $\frac{3}{4}$ of the thickness of layer. Quantities of materials shall be in accordance with Table given below.

	Percent Passing by Weight			
	Coarse Aggregate	Key Aggregate	Cover Aggregate	Seal Aggregate
75mm	100			
63mm	90-100			
50mm	35-70			
38mm	0-15	100		
25mm		90-100		
19mm		40-75	100	
12.5mm		15-35	90-100	100
9.5mm		0-5	40-75	85-100
4.75mm		0-5	5-25	10-40
2.38mm		-	0-10	0-10
1.18mm		-	0-5	-

Table 37, Aggregate Gradation

Sequence of Operation	Quantity of Materials Per Sq. M.				
	Bitumen kgs.	Coarse Aggregate Cu. m.	Key Aggregate Cu. m.	Cover Aggregate Cu. m.	Seal Aggregate Cu. m.
First Spreading	--	0.09	--	--	--
First Application	7.33	--	--	--	--
Second Spreading	--	--	0.02	--	--
Second Application	1.71	--	--	--	--
Third Spreading	--	--	--	0.011	--
Third Application (Seal)	0.68	--	--	--	--

Seal Spreading	--	--	--	--	0.004
----------------	----	----	----	----	-------

Table 38, Quantities of Material for 75mm Thick Penetration Macadam

Sequence of Operation	QUANTITY OF MATERIALS PER Sq. m.				
	Bitumen kgs.	Coarse Aggregate Cu. m.	Key Aggregate Cu. m.	Cover Aggregate Cu. m.	Seal Aggregate Cu. m.
First Spreading	--	0.061	--	--	--
First Application	4.88	--	--	--	--
Second Spreading	--	--	0.015	--	--
Second Application	1.71	--	--	--	--
Third Spreading	1.22	--	--	0.010	--
Third Application (Seal)	0.68	--	--	--	--
Seal Spreading	--	--	--	--	0.046

Table 39, Quantities of Material for 50mm Thick Penetration Macadam

16.4.7.3 Construction Requirements and Details

1. Weather Limitations

Penetration macadam shall not be placed on any wet surface, when the air temperature is below 18.9°C or when weather conditions otherwise would prevent the proper construction of the pavements.

NOTE: Dates may be established between which no bituminous penetration macadam pavement shall be placed except with written approval.

2. Equipment

The equipment to be used shall include a power broom (Hand brooms may be used if sufficient labour is available), or a power blower, (8 – 12 ton) rollers, spreader as may be approved by the Engineer for spreading coarse aggregates, a bituminous binder distributor, and equipment for heating bituminous material.

3. Placing and Compacting Coarse Aggregate

Immediately before placing coarse aggregates the surface upon which the pavement is to be constructed shall be swept clean. Coarse aggregate shall be placed in the required amount by approved stone spreaders, or by other approved methods. All areas of non – uniformly graded aggregate shall be removed and replaced with suitable material before the rolling begins. These corrections shall be made by hand picking whenever necessary and shall be continued after initial rolling until the appearance and texture of the aggregate are uniform and all irregularities are corrected. The coarse aggregate shall be dry rolled giving two coverage of 8 – 12-ton roller. Rolling shall be a parallel to the road center line and shall start at the outer edges of the road, overlap equal portions of aggregate and shoulder and progress toward the center, overlapping on successive passes by at least one – half the width of the roller except that on super elevated curves rolling shall progress from the lower to the upper edge. Material which crushes under the roller or becomes segregated in such manner as to prevent free and uniform penetration of the bituminous material shall be removed and replaced with the suitable aggregate. The compacted coarse aggregate shall have a firm, even surface and any irregularities in the surface profile shall be made good by raking or filling. Along curbs, headers, and walls, and at all places not accessible to the roller, the aggregate shall be tamped thoroughly with mechanical tampers or with hand tampers. Each hand tamper shall weigh not less than 13.60 kgs, and have a face area of not more than 645 square cms. Aggregate in any course that becomes coated or mixed with dirt or clay prior to the application of the bituminous material shall be removed and replaced with clean aggregate, and the area shall be rerolled. Dry rolling shall be stopped when the surface of the coarse aggregate will support the distributor and before the voids are closed to prevent the free uniform, penetration to the bituminous material. Prior to application of the bituminous material, the surface of the aggregate will be tested by the Engineer using a 3m straight edge at selected location. The version of the surface from the testing edge of the straight edge between any two contacts with the surface shall at no point exceed 4.75mm. All humps or depression exceeding the specified tolerance shall be corrected by removing defective work and replacing it with new material as specified.

4. Application of Bituminous Material

Bituminous material shall be uniformly applied by distributor at the rate specified. The bituminous binder shall be heated at the specified temperature for the grade of the bitumen used. Successive spray widths shall be overlapped by an amount sufficient to give a uniform rate of spread over the joint. During the application of bituminous material care shall be taken to prevent spattering adjacent pavements, structures and trees. The distributor shall not be cleaned or discharged into ditches, borrow pits on the shoulders or along the right of way.

5. Application of Key Aggregate

Immediately following the first application of bituminous material, key or choke aggregate shall be spread and worked into the voids of the coarse aggregate by broom dragging and rolling. Additional key aggregate shall be spread as required, broom dragged and rolled until the course is uniformly filled and compacted.

6. Cover and Seal Coat

shall be applied. The loose stone on the surface shall be brushed off, and the surface sprayed with the quantity of bitumen specified in the manner. The cover aggregate of the size specified shall be spread within 15 minutes of applying the bitumen and rolled with a steel tyred roller or pneumatic tyred roller. Rolling shall not be continued if the aggregate shows excessive crushing. The surface may be opened to traffic after this treatment if no rain is anticipated for up to 3 months or otherwise the seal coat shall be provided at the earliest. Before applying the final seal coat, all loose chipping or foreign matter shall be removed with brooms or blowers. The bitumen specified shall then be sprayed at the specified rate of spread and covered with

seal aggregate within 15 minutes. The surface shall be rolled and surplus aggregate removed after 7 days.

7. Stockpiling

Stockpiling of aggregate shall be carried at points specified on the plans or approved by the Engineer in accordance with specifications of course aggregate for concrete.

16.4.7.4 Measurement and Payment

1. Measurement

Penetration macadam in one or more courses for the specified thickness shall be measured by superficial area. The unit of measurement shall be square meter.

2. Payment

The unit rate shall be full compensation for furnishing and applying the bituminous material and aggregate in the specified quantities, including all material, labour, equipment, tools and incidentals necessary to complete the work prescribed in this Section.

Pay Item No	Description	Unit of Measurement
16.4.7.4.2	Penetration macadam in one or more courses of specified thickness	m ² or 100 sft.

16.4.8 Asphaltic Base Course Plant Mix

16.4.8.1 Description

This work shall consist of furnishing of plant, labor, equipment and material and performing all operations in connection with the construction of an asphaltic plant mix base course on a previously constructed and accepted subgrade, subbase or base course, subject to terms and conditions of the Contract, and in strict accordance with this Section of the Specification, the Drawings and the directions of the Engineer.

16.4.8.2 Material Requirements

1. Mineral Aggregate

Mineral aggregates for bituminous base course shall consist of coarse aggregate fine aggregate and filler material, if required, all conforming to the following requirements: -

- Coarse aggregate which is the material retained on AASHTO No. 4 sieve shall consist of crushed rock, crushed gravel or crushed boulder. It shall be clean, hard, tough, sound, durable free from decomposed stones, organic matter, shale, clay lump or other deleterious substances. Rock or boulders from which coarse aggregate is obtained, shall be of uniform quality throughout the quarry.
- The crushing shall be so regulated that at least ninety-five (95) percent by weight of material retained on AASHTO No. 4 sieve shall consist of pieces with at least two (2) mechanically fractured faces, and when tested for stability of bituminous mix shall show satisfactory stability.
- Fine aggregate which is material passing No. 4 sieve, shall consist of 100% crushed material from rock or boulder. No natural sand will be allowed in the mix.

- When the combined grading of the coarse and fine aggregates is deficient in material passing No. 200 sieve, additional filler material shall be added. The filler material shall consist of finely divided rock dust, hydrated lime, hydraulic cement or other suitable mineral matter. However, in case the coarse aggregates are of quartzitic nature, then hydrated lime or a better material shall be allowed. At the time of use, it shall be sufficiently dry to flow freely. Filler material shall conform to following gradations.

US Standard	Percent Passing by Weight
No. 30	100
No. 50	95-100
No. 200	70-100

Table 40, Gradation

The coarse and fine aggregates shall meet the following applicable requirements: -

- The Percentage of wear by the Los Angeles Abrasion test (AASHTO T 96) shall not be more than forty (40).
- The loss when subject to five cycles of the Sodium Sulfate Soundness test (AASHTO T 104) shall be less than twelve percent.
- The Sand Equivalent (AASHTO T 176) determined after all processing except for addition of asphalt cement shall not be less than forty-five (45).
- Fine aggregates shall have a liquid limit not more than twenty-five (25) and a Plasticity Index of not more than six (6) as determined by AASHTO T 89 and T-90.
- The portion of aggregate retained on the 9.5 mm (3/8 inch) sieve shall not contain more than 15 percent by weight of flat and/or elongated particles (ratio of maximum to minimum dimensions = 2.5:1).
- Stripping test shall be performed on coarse aggregates as described under AASHTO T-182 and only that material shall be allowed which qualifies the test.
- The coarse aggregates shall be checked if desired by the Engineer for cationic and anionic behavior so that their affinity with the bitumen to be used is verified.
- Petrographic examination of the coarse aggregate shall be conducted if so directed by the Engineer.

2. Asphaltic Material

Asphalt binder to be mixed with the aggregate to produce asphaltic base shall be asphalt cement having penetration grade 40-50, 60-70 or 80-100 as specified: by the Engineer. Generally, it will meet the requirements of AASHTO M -20.

3. Asphalt Concrete Base Course Mixture

The composition of the asphaltic concrete paving mixtures for base course shall conform to Class A and/or Class B shown in the following table: -

Mix Designation	Class A	Class B
Use	Leveling/Base	Leveling/Base
Compacted Thickness	70-90 mm	50-80 mm
U.S. Standard Sieve Size Percent passing by weight		
2" (50mm)	100	
1 ^{1/2} " (38mm)	90-100	100
1" (25mm)	-	75-90
¾"(19mm)	56-75	65-80

½" (12.5 mm)	-	55-70
3/8" (9.5 mm)	-	45-60
No. 4 (4.75 mm)	23-40	30-45
No.8(2.38mm)	15-30	15-35
No. 50 (0.300 mm)	4-10	5-15
No. 200 (0.075 mm)	3 - 6	2- 7
Asphalt Content weight percent of total mix	3 (Minimum)	3 (minimum)

Table 41, Combined Aggregate Grading Requirements

The asphalt concrete leveling / base course mixture shall meet the following Marshall Test Criteria.

Compaction, number of blows each end of specimen	75
Stability	1000Kg/(Min.)
Flow, 0.25 mm (0.01 in.)	8-14
Percent air voids in mix	4-8
Percent voids in mineral aggregates	According to Table. -5.3 MS-2 Asphalt institute, sixth edition 1993.
Loss in Stability	25 percent (max.)

Table 42, Marshall Test Criteria

Mixes composed of larger size aggregates with maximum size up to 38 mm (1.5 inches) will be prepared according to modified Marshall Method as per MS-2 Asphalt institute, sixth edition, 1993 or the latest edition. The procedure is basically the same as the original method except for following differences that are due to the larger specimen size used: -

- The hammer weighs 10.2 kg (22.5 lb.) and has a 149.4 mm (5.88 inches) flat tamping face. Only mechanically operated device is used for the same 457 mm (18 inches) drop height.
- The specimen has a 152.4 mm (6 inches) diameter by 95.2 mm (3.75 inches) height.
- The batch weights are typically of 4 Kg.
- The equipment for compacting and testing (molds and breaking heads) are proportionately larger to accommodate the larger specimens.
- The mix is placed in the mold in two approximately equal increments, with spading performed after each increment to avoid honey combing.
- The number of blows needed for the larger specimen is 1.5 times (75 or 112 blows) of that required for the smaller specimen (50 or 75 blows) to obtain equivalent compaction.
- The design criteria shall be modified as well, the minimum stability shall be 2.25 times and the range of flow values shall be 1.5 times normal sized specimens.
- Similar to the normal procedure, following values shall be used to convert the measured stability values to an equivalent value for a specimen with a 95.2 mm (3.75 inches) thickness, if the actual thickness varies:

Approximate Height		Specimen volume	Correlation
mm	(inches)	(Cubic cm)	Ratio
88.9	(3 1/2)	1608 to 1626	1.12
90.5	(3 9/16)	1837 to 166	1.09
92.1	(3 5/8)	1666 to 1694	1.06
93.7	(3 11/16)	1695 to 1723	1.03
95.2	(3 3/4)	1724 to 1752	1.00
96.8	(3 13/16)	1753 to 1781	0.97
98.4	(3 7/8)	1782 to 1810	0.95
100.0	(3 15/16)	1811 to 1839	0.92
101.6	4	1840 to 1968	0.90

Table 43, Specimen Requirement

4. Job-Mix Formula

- At least one (1) week prior to production, a Job-Mix Formula (JMF) for the asphaltic base course to be used for the project, shall be established jointly by the Engineer and the Contractor in the project laboratory. Job mix formula shall combine the mineral aggregates and asphalts in such proportion conforming to specification requirements.
- The JMF shall be established by MARSHALL Method of Mix Design according to the procedure prescribed in the Asphalt Institute Manual Series No. 2 (MS-2), sixth edition 1993, or the latest Edition.
- The JMF, with the allowable tolerances shall be within the range specified in Item. Each JMF shall indicate a single percentage of aggregate passing each required sieve size and a single percentage of bitumen to be added to the aggregate.
- The ratio of weight of filler (passing sieve No. 200) to that of asphalt shall range between 1.1.5 for hot climate areas with temperature more than 40°C.
- After the JMF is established, all mixtures furnished for the project represented by samples taken from the asphalt plant during operation, shall conform thereto Moreover upon receiving the job-mix, approved by the Engineer, the Contractor shall adjust his plant to proportion the individual aggregates, mineral filler and asphalt to produce a final-mix that, when compared to job mix formula shall be within the following limits.
- In addition to meeting the requirements specified in the proceeding items, the mixture as established by the JMF shall also satisfy the following physical property.
- Loss of Marshall Stability by immersion of specimen in water at sixty (60) degree centigrade for 24 hours as compared with stability measured after immersion in water at 60 degrees centigrade for 20 minutes shall not exceeds twenty-five (25) percent. If the mixture fails to meet this criterion, JMF shall be modified or an anti-stripping agent shall be used.
- Should a change of sources of materials be made, a new Job Mix Formula shall be established before the new material is used. When unsatisfactory results or other conditions make it necessary, a new Job Mix Formula will be required.

16.4.8.3 Construction Requirements

16.4.8.3.1 Equipment

1. Asphalt Mixing Plant

Plants used for the preparation of bituminous mixtures shall be "Batching Plants" conforming to AASHTO M 156 or ASTM Designation D995-617, and of adequate capacity, coordinated

and operated to produce a mixture within the limits of these specifications. Plant shall have minimum three cold bins and at least 3.5 decks of hot sieves.

All plants, used by the Contractor, shall be designed, coordinated and operated to produce a mix uniformly within the job- mix tolerances as listed herein and in accordance with AASHTO M-156. The plant may be either a weight batch type or a volumetric proportioning, continuous/drum mixing type, provided the equipment has demonstrated that it is suitable for producing finished mixtures complying with the job-mix formula specified herein.

The plant shall be equipped with the necessary equipment for storing, handling, drying, heating and mixing the aggregate and asphalt. Satisfactory means shall be provided for aggregate and asphalt control as to quantity and temperature. Adequate safety measures shall be provided on stairs, gears, pulley, chains, sprockets, and all other dangerous moving parts.

Contractor shall calibrate the asphalt plant not more than thirty (30) days in advance of production and furnish copies of the data to the Engineer at least one day prior to asphalt concrete production. Aggregate and asphalt cement sampling locations meetings OSHA safety requirements shall be provided. Proportioning (batch) scales shall not be used for weighing material for payment. Weight scales used in conjunction with a storage silo may be used to weight the final product for payment, provided the scales are certified by the State of Alaska. The asphalt plant shall maintain a current Air Quality Permit issued by the State of Alaska.

2. Preparation of Aggregates

Before being fed to the dryer, aggregates for the asphaltic base courses shall be separated into three or more sizes and stored separately in cold bins. One bin shall contain aggregate of such size that eighty (80%) percent will pass sieve No. 4 and the other two bins shall contain aggregate of such sized that eighty (80) percent will be retained on Sieve No. 4. Should fine material be incorporated in the mix, separate bin shall be provided in addition to three bins mentioned above. If filler is used as a separate component it will also be stored and measured separately and accurately before being fed into the mixer through filler screw mechanism.

Asphalt cement shall be heated within a temperature range of hundred and thirty-five to hundred and sixty-three (135-163) ° degrees centigrade at the time of mixing. Asphalt cement heated above maximum temperature shall be treated as overheated and shall be rejected and removed from job site. Dried aggregate weighed and drawn to pugmill shall be combined with proportionate quantity of asphalt cement according to the job mix formula Temperature of asphalt, except for temporary fluctuations, shall not be lower than fifteen (15°) degrees centigrade below the temperature of the aggregate, at the time, the two materials enter into the pugmill. For placing the materials in bins or in moving them from bins to the dryer, any method which causes segregation or uncontrolled combination of materials of different grading, shall be discontinued and the segregated or degraded materials shall be prescreened for reuse. Each aggregate ingredient shall be heated and dried at temperature not to exceed hundred and sixty-three (163), degrees centigrade, if aggregate contain sufficient moisture to cause foaming in the mixture or their temperature is in excess of hundred and sixty-three (163) degrees centigrade, they shall be removed from the bins and returned to their respective stock piles. In no case, shall the temperature of asphaltic mix exceed 163 degree centigrade when discharged from the pugmill. Immediately after heating, the aggregates shall be screened to required sizes and stored in separate hot bins for batching and mixing with bituminous material. Asphalt plant shall have minimum three and half (3½) sieve decks to effectively control the gradation of hot bins.

3. Transportation and Delivery of Mixtures-Hauling Equipment

Dump truck used for hauling bituminous mixtures shall have tight, clean, smooth metal beds which have been thinly coated with an approved material to prevent adhering of material to the beds. Each truck shall have a cover of canvas or of other suitable material of sufficient size as to protect the mixture from the weather. The mixture will be delivered on the road at a temperature not less than hundred and thirty (130°) degree C. Drivers of dump trucks will ensure that while reversing the vehicles, paver is not pushed back producing a hump.

4. Bituminous Pavers

Bituminous pavers shall be self-contained, power propelled units, provided with an automatically controlled activated screed or strike off assembly, heated if necessary, capable of spreading and finishing courses of bituminous plant mix material in lane widths applicable to the specified typical section and thickness shown on the plans. Pavers used for shoulders and similar construction shall be capable of spreading and finishing course of bituminous plant mix material in widths shown on the plans. The paver shall be equipped with a receiving hopper having sufficient capacity for a uniform spreading operation. The paver shall be equipped with automatic feed controls, properly adjusted to maintain a uniform depth of material ahead of the screed. The screed or strike off assembly shall be capable of producing a finished surface of the required evenness and texture without tearing, shoving or gouging the mixture. When laying the mixtures, the paver shall be capable of being operated at forward speeds consistent with satisfactory laying of the mixture. The paver shall be operated at speeds which will give the best result for the type of power being used. The mixed material shall be delivered to paver in time to permit completion of spreading, finishing and compaction of mixture during day light hours. The paver shall be equipped with automatic screed controls with sensors for either or both sides of the paver, capable of sensing grade from an outside reference line, sensing the transverse slope of the screed and providing the automatic signals and operates the screed to maintain the desired grade and transverse slope. The sensor shall be so constructed that it will operate from a reference line or a ski like arrangement. The transverse slope controller shall be capable of maintaining the screed at the desired slope within plus or minus 0.1 percent variation. Manual operation will only be permitted in the construction of irregularly shaped and minor areas. Whenever a breakdown or malfunctioning of the automatic controls occurs, the equipment may be operated manually or by other methods in order to allow the contractor to use the asphalt already produced at the plant or in transit, provided this method of operation will produce results otherwise meeting the specifications. Reference lines will be required for both outer edges of the traveled way for each main line roadway for vertical control. Horizontal control utilizing the reference line will be permitted. The grade and slope for intermediate lanes shall be controlled automatically from reference lines or by means of a ski and a slope control device or a dual ski arrangement. When the finish of the grade prepared for paving is superior to the established tolerance and, when in the opinion of the Engineer, further improvement to the line, grade, cross sections and smoothness can best be achieved without the use of the reference line, a ski like arrangement may be substituted subject to the approval of the Engineer. The use of the reference lines shall be reinstated immediately whenever the Contractor fails to maintain a superior pavement. The Contractor shall furnish and install all pins, brackets, tensioning devices, wire and accessories necessary for satisfactory operation of the automatic control equipment.

The following specific requirements apply to the following identified bituminous pavers: -

- Blaw-Knox bituminous paver shall be equipped with the Blaw-Knox Materials Management Kit (MMK).
- Cedarapids bituminous paver must have been manufactured in 1989 or later.
- Caterpillar bituminous pavers shall be equipped with the following deflector plate models: 6630, 6631, or 6640.

Contractor shall provide a Certificate of Compliance that verifies the required mechanism has been installed to prevent bituminous paver segregation. The Engineer shall approve all mechanisms proposed by Contractor for preventing paver segregation of coarse aggregate prior to the bituminous paver's use on the project.

5. Rollers

Rollers shall be steel wheel, pneumatic tyres and vibratory, or a combination thereof. The roller(s) shall be in good condition, capable of reversing without backlash, and shall be operated at speeds slow enough to avoid displacement of the bituminous mixture. The number and weight of rollers shall be sufficient to compact the mixture to the required density while it is still in a workable condition. Vibratory rollers shall be acceptable for bituminous mixture compaction. The use of equipment, which results in excessive crushing of the aggregate, will not be permitted. There shall be at least one operator for each roller.

a. Pneumatic Tired Rollers

Pneumatic tired roller shall ride on not less than seven uniformly sized and uniformly inflated smooth tires mounted on wheel rims of twenty inch (20") minimum diameter. The rear group of tires shall align behind and cover the spaces between the forward group of tires. Tires shall be inflated, and the roller ballasted, to provide a uniform (plus or minus five [5] pounds per square inch) minimum ground contact weight of seventy (70) pounds per square inch, unless a lower weight is requested in writing by the Engineer. If a pneumatic roller experiences a pick-up problem, the Contractor shall be required to add an effect release agent to the tire watering tank.

b. Steel-Drum Rollers

Steel-wheel roller may be of two (2) types: -

- Two-axle static drum rollers, 8 to 22 tons in weight.
- Two-axle vibratory drum rollers, 8 to 22 tons in weight.

All rollers shall be equipped with power units of not less than four (4) cylinders and under working conditions shall develop a compression in the rear wheels of two hundred fifty (250) to three hundred fifty (350) pounds per inch of roller width. Rollers shall be in good working condition and be free from backlash, faulty steering mechanism, or worn parts. Rollers shall be equipped with adjustable scrapers to keep the drums clean and with efficient means of keeping the drums/wheels wet to prevent mixes from sticking to the drums. Rollers/Drums shall be free of flat areas, openings or projections which will mar the surface of the pavement.

6. Preparation of Base or Existing Pavement Surface

Before spreading materials, the surface of base or existing pavement on which the mix is to be placed shall be conditioned by application of a prime or tack coat as specified. After a prime coat is applied, it shall be left undisturbed not less than twenty-four (24) hours. The Contractor shall maintain the primed surface until the mix material has been placed. This maintenance shall include the spreading of sand or other approved material if necessary, to prevent adherence of the prime coat to the tyres of vehicles using the primed surface, and patching breaks in the primed surface with additional bituminous material: Any area of primed surface that has become damaged shall be repaired before the mix is placed, to the satisfaction of Engineer. It shall be ensured that primed surface is not in tacky condition, when premix is laid. After a tack coat is applied, it shall be allowed to dry until it is in the proper condition of tackiness to receive the mix. The tack coat shall be applied only as far in advance of the

placing of mix as is necessary to obtain the proper condition of tackiness. Any breaks in the tack coat shall be repaired. When the surface of the existing pavement or old base is irregular, it shall be brought to uniform grade and cross section by leveling course as directed. A thin coating of bituminous material shall be sprayed on contact surface of curbing, gutters, manholes, and other structures; prior to the bituminous mixture being placed against them.

7. Spreading and Finishing

- The mixture shall be laid upon an approved surface, spread and struck off to the section and elevation established. Bituminous pavers shall be used to distribute the mixture either over the entire width or over such partial width as may be practicable.
- The longitudinal joint in one layer shall offset to that in the layer immediately below, by approximately 15.0 cm; however, the joint in the top layer shall be at the centerline of the pavement if the roadway comprises two lanes of width, or at lane lines if the roadway is more than 2 lanes in width.
- On areas where irregularities or unavoidable obstacles make the use of mechanical spreading and finishing equipment impracticable, the mixture shall be spread, raked and luted by hand tools. For such areas the mixture shall be dumped, spread and screened to give the required compacted thickness, ensuring even distribution of coarse and fine material.
- When production of the mixture can be maintained and wherever practical, pavers shall be used in echelon to place the wearing course in adjacent lanes and compacted to form a surface without lateral joint.
- All mixtures shall be spread at a temperature of not less than hundred and thirty (130°C) degree centigrade and all initial rolling or tamping shall be performed when the temperature of the mixture is such that the sum of the air temperature plus the temperature of the mixture is between 165°C and 190°C be mixture shall not be placed on any wet surface or when weather conditions will otherwise prevent its proper handling or finishing.
- Only lutes or asphalt rakes shall be used during the spreading operation and when finishing by hand.
- Tamping irons shall weigh not less than twenty-five (25) pounds and shall have a bearing area not exceeding forty-eight (48) square inches. Mechanical compaction equipment, satisfactory to the Engineer, may be used instead of tamping irons.
- Straightedges ten (10') and sixteen feet (16') in length, to test the finished surface, shall be provided by the Contractor. The sixteen-foot (16') straightedge shall be used on straight sections and the ten-foot (10') straightedge on vertical curves or crown.

8. Compaction

- After spreading and strike off and as soon as the mix condition permits the rolling to be performed without excessive shoving or tearing, the mixture shall be thoroughly and uniformly compacted. Rolling, shall not be prolonged when cracks appear on the surface.
- Initial or breakdown rolling shall be done by means of either a tandem steel roller or three wheeled steel rollers. Rolling shall begin as soon as the mixture will bear the roller without undue displacement.
- The number and weight of rollers shall be sufficient to obtain the required compaction while the mixture is still in workable condition. The sequence of rolling and the selection of roller types shall provide the specified pavement density. Initial rolling with a tandem steel roller or a three wheeled steel roller shall follow the paver as closely as possible.
- Unless otherwise directed, rolling shall begin at the lower side and to proceed longitudinally, parallel to the road centerline, each trip overlapping one half ($\frac{1}{2}$) of the roller width, gradually progressing to the crown of the road. When paving in echelon or abutting a previously placed lane, the longitudinal joint should be rolled first followed

by the regular rolling procedure. On super elevated curves the rolling shall begin at the low side and progress to the high side by overlapping of longitudinal trips parallel to the centerline. Intermediate rolling with a pneumatic tyred roller shall be done behind the initial rolling. Final rolling shall eliminate marks from previous rolling. In no case shall the temperature be less than hundred and twenty (120) degree C. for initial break down rolling while all other compaction operations shall be completed before the temperature drops down to hundred and ten (110°C) degree.

- Rollers shall move at a slow but uniform speed with the drive roll or wheels nearest the paver. Rolling shall be continued until all roller marks are eliminated and a minimum density of Ninety-seven (97) percent of a laboratory compacted specimen made from asphaltic material obtained for daily Marshall Density is achieved.
- Any displacement resulting while reversing the direction of a roller, or from other causes, shall be corrected at once by the use of rakes and addition of fresh mixture, when required. Care shall be exercised in rolling not to displace the line and grade of the edges of the bituminous mixture.
- To prevent adhesion of the mixture to the rollers, wheels of rollers shall be kept properly moistened with water or water mixed with very small quantities of detergent or other approved material. Excess liquid will not be permitted.
- Along forms; curbs headers walls and other places not accessible to the roller, the mixture shall be thoroughly compacted with hot hand tampers, smoothing irons or with mechanical tampers. On depressed areas, tampers or cleated compression strips may be used under the roller to transmit compression to the depressed area
- Any mixture that becomes loose and broken, mixed with dirt, or is in any way defective in finish or density shall be removed and replaced with fresh hot mixture, which shall be compacted to conform to the surrounding area. Any area showing an excess or deficiency of bituminous material shall be removed and replaced.
- Sequence of laying and compaction of premix shall be so managed, that a long time does not elapse between successive dump trucks, which may cool down the uncompacted premix, between paver and compacted asphalt below 120°C.

16.4.8.4 Quality Control

1. Frequency of Testing for Cores

One core shall be taken for each 100 linear meters of each lane of Asphaltic Base, or fraction thereof, in special cases. If the core so taken is failed against the specified 97% density, then two (2) additional cores shall be taken in the longitudinal alignment of the road at an interval of three (3) meters on either side with respect to the failing core and shall be tested against field density. If all the three cores give an average of 97% compaction, and the individual compaction of the core is not less than ninety-five (95) percent, then the compaction is acceptable. If average of the cores further fails against compaction, then retake the cores at a distance of fifteen (15) meters on either side and compaction shall be checked for all the five cores in the same fashion. If average of five cores is 97%, the area will be accepted. In case average is ninety-six 96% or more, then Engineer may withhold the payment in full or partly and observe behavior during maintenance period, for the release of payment or otherwise. In case of failure of the average of these five cores giving average compaction of less than 96%, the failed area shall be removed and subsequently be replaced by specified mix in an approved manner at the expense of contractor.

2. Surface Tolerances

After completion of final rolling, the finished surface shall be tested for smoothness with three (3) meters straightedge by Engineer at selected locations. The variation of surface from testing edge of straight edge between any two (2) contacts with the surface shall at no point exceed

six (6) millimeters when placed either parallel or perpendicular to centerline of roadway. Any irregularities that exceed the specified tolerances or that retain water on the surface shall be corrected by removing the defective area and replacing with new asphaltic base course without additional cost to the Employer.

3. Base Thickness Tolerances

For determination of thickness, one (1) core for each hundred (100) linear meter of each lane shall be taken unless, otherwise permitted, cores extracted for thickness measurement shall not be used for density determination and density cores shall not be used for thickness measurements. When layer thickness of asphaltic base course is deficient by more than five (5) mm from that specified in the Drawings, the deficiency shall be removed with satisfactory base course material and/or made up by additional asphalt concrete wearing course thickness without extra cost to the Employer. If such remedial action is authorized, revised thickness determinations shall be made by measurements of new cores taken after placing of "Asphaltic Wearing Course" material or as directed by the Engineer. If base course deficiencies are corrected in this manner, full payment for the "Asphaltic Base Course" will be made to the Contractor, but no additional payment will be made for the increase in thickness of the "Asphaltic Wearing Course".

4. Acceptance Sampling and Testing

Acceptance of samples and testing of materials and construction requirements, shall be governed by the relevant, "Table for Sampling and Testing Frequency" or as approved by the Engineer.

5. Weather Limitations

Hot asphaltic mixtures shall be placed only when the air temperature is four (4) degrees centigrade or above and no asphalt shall be laid under foggy or rainy weather or over moist surface.

6. Trial Section

Contractor shall prepare a trial section before the start of work in light of procedure given in clause 1.20 (General).

16.4.8.5 Measurement and Payment

1. Measurement

The quantities for asphaltic leveling / base course will be measured by volume in cubic meters compacted in place. Measurement shall be based on the dimension as shown on plan or as otherwise directed or authorized by the Engineer. No measurement shall be made for unauthorized areas or for extra thickness. The quantity of asphaltic material used is included in the asphalt concrete mixture and will not be measured separately. Quantities of liquid asphalt, wasted or remaining on hand after completion of the work shall not be measured or paid for.

2. Payment

The quantities determined as provided above shall be paid for at the, contract unit price respectively for each of the particular pay items listed below and shown in the Bill of Quantities, which prices and payment shall constitute full work prescribed in this item. Asphalt additive or

anti-stripping agent, if allowed and used to meet with JMF requirement shall not be paid directly, payment shall be deemed to be included in the respective pay items of Asphaltic Base Course.

Pay Item No.	Description	No. of Measurement
16.4.8.5.2.1	Asphaltic Leveling Course Plant Mix (Class A & B)	Cubic feet
16.4.8.5.2.2	Asphaltic Base Course Plant Mix (Class A & B)	Cubic Feet

16.4.9 Asphaltic Concrete Binder Course

16.4.9.1 Description

This work shall consist of furnishing and mixing aggregates and asphalt binder at a central mixing plant; transporting, spreading and Compacting the mixture on a prepared base in accordance with these specifications and to the lines, grades and typical pavement sections shown on the Drawings or as directed by the Engineer.

16.4.9.2 Material Requirements

1. Aggregates

- Coarse and fine aggregates shall be clean, hard, tough, sound particles free from decomposed material, vegetable matter and other deleterious substances, and be of uniform quality, geology, and petrology. Water borne material, e.g. river bed gravel, if used, shall also conform to the above criteria.
- Coarse aggregate, which is material retained on the No. 4 sieve, shall consist of crushed rock, crushed gravel or a mixture of natural and crushed gravel. The aggregate shall contain, not more than 8% by weight of flats/or elongated particles (ratio maximum to minimum 5:1) and shall contain 100% angular material, such that all faces of each piece are fractured faces in cuboid shape.
- Fine aggregate, which is material passing the No. 4 sieve shall consist of 100% crushed material from rock or boulder. No natural sand will be allowed in the mix.
- When the combined grading of the coarse and fine aggregates is deficient in material passing the No. 200 sieve, additional filler material shall be added. The filler material shall consist of finely divided rock crust, hydrated lime, hydraulic cement or other suitable mineral matter and shall conform to the following gradation: -

US Standard	Percent Passing by Weight
No. 30	100
No. 50	95-100
No. 200	70-100

Table 44, Gradation

The Coarse and fine aggregates shall meet the following requirements: -

- The percentage of wear by the Los Angeles Abrasion test (AASHTO T 96) shall not be more than 40%.
- The loss when subject to five cycles of the Sodium Sulfate Soundness test (AASHTO T-140) shall be less than 12%.

- The Sand Equivalent (AASHTO T-176) determined after all processing except for addition of asphalt cement should not be less 45.
- All aggregates shall have a liquid limit of net more than 25% and a Plasticity Index of not more than 4 as determined by AASHTO T-89 and T-90.
- The portion of aggregate retained on the 9.5 mm (3/8 inch) sieve shall not contain more than 15 percent by weight of flat and/or elongated particles (ratio of maximum to minimum dimensions = 2:5:1).

2. Asphaltic Material

Asphaltic binder to be mixed with the aggregate to produce asphaltic base shall be as asphalt cement penetration grade 40-50, or 60-70 or 80-100, as specified by the Engineer. Generally, it will meet the requirement of AASHTO M-20.

3. Asphalt Concrete Binder Course Mixture

The composition of the asphaltic concrete paving mixture for binder course shall conform to class shown in the following table: -

Sieve Designation		Percent Passing by
mm	Inch	Weight
25	1	100
19	3/3	90-100
9.5	3/8	56-80
4.75	No. 4	35-65
2.38	No. 8	23-49
0.30	No. 50	5-19
0.075	No. 200	2-8

Table 45, Combined Aggregate Grading Requirements

Asphalt Content Weight Percent of total mix. 3.5 (minimum)	
The asphalt concrete binder course mixture shall meet the following Marshal Test Criteria:	
Compaction, number of blows each end of Specimen	75
Stability (Minimum)	1000 kg
Flow, 0.25 mm (0.01")	8-14
Percent air voids in mix.	4-8
Percent voids in mineral aggregate	According to article 5.3, MS-2, (Asphalt Institute USA) edition 1993 25 %
Loss of stability	25 % (Max.)
Filler/Bitumen ratio	1-1.5 applicable to hot climate (>45°C)

Table 46, Marshall test Criteria

4. Combined Aggregates Gradation

Retained No. 4	± 7.0 %
Passing No. 4 to No. 100 sieves	± 4.0 %
Passing No. 200	± 1.0 %
Asphalt Content	
Weight percent of total mix.	± 0.3%

Table 47, Combined Aggregate Gradation

- Should a change of sources of materials be made a new Job Mix Formula shall be established before the new material is used. When unsatisfactory results or other conditions made it necessary, a new Job Mix Formula will be required.

5. Job Mix Formula

- At least one week prior to production, a Job Mix Formula (JMF) for the asphaltic concrete course mixture or mixtures to be used for the project, shall be established jointly by the Engineer and the Contractor.
- The JMF shall be established by Marshal Method of Mix Design according to the procedure prescribed in the Asphalt Institute Manual Series No. 2 (MS-2), May 1992 Edition.
- The JMF, with the allowable tolerances, shall be within the master range specified in Table No. 1. Each JMF shall indicate a single percentage of aggregate passing each required sieve size and a single percentage of bitumen to be added to the aggregates.
- After the JMF is established, all mixtures furnished for the project represented by samples taken from the asphalt plant during operation, shall conform thereto to the tolerances.

16.4.9.3 Construction Requirements

Construction requirements for this item shall conform to the same construction requirements specified for Asphaltic Concrete Base Course Plant Mix, except as modified in the following sub items.

1. Preparation of Base Course Surface

Before spreading materials, the surface of the previously constructed and accepted base course on which the mix is to be placed shall be conditioned by application of a tack/or prime coat, as directed by the Engineer.

2. Pavement Thickness and Tolerances

- The asphalt concrete binder course shall be compacted to the desired level and cross slope as shown on the drawings or as directed by the Engineer.
- The tolerances in compacted thickness of the binder course shall be ± 10 percent from the desired thickness shown on the drawings. For determination of the thickness, one (1) core per hundred meters of each lane will be taken.
- If the thickness so determined is deficient by more than ± 10 percent, the Engineer shall decide whether to accept the deficit thickness to direct reconstruction.
- The surface of the binder course shall be tested by the Engineer using at 3-meter straight edge at selected locations. The variation of the surface from the testing edge of the straightedge between any two contacts, longitudinal or transverse with the surface shall at no point ± 5.0 millimeters, the cross fall (camber) shall be within ± 0.2 percent of that specified, and the level at any point shall be within drawings. All humps or depressions exceeding the specified tolerance shall be corrected by removing the defective works and replacing it with new material, by overlaying, or by other means satisfactory to the Engineer.

16.4.9.4 Measurement and Payment

1. Measurement

The quantities of asphaltic binder course shall be measured per cubic meter basis. The quantity of asphaltic material used is included in the asphalt concrete mixture and will not be

measured separately. Quantities of liquid asphalt, wasted or remaining on hand after completion of the work shall not be measured or paid for.

2. Payment

The quantities determined, as provided above, shall be paid for at the contract unit price respectively for each of the particular pay item listed below and shown in the Bill of Quantities, which prices and payment shall constitute full compensation for all the costs necessary for the proper completion of the work prescribed in this item: -

Pay Item No.	Description	Unit of Measurement
16.4.9.4.2	Asphaltic Concrete Binder Course	CM

16.4.10 Asphaltic Concrete Wearing Course – Plant Mix

16.4.10.1 Description

The work shall consist of furnishing aggregates and asphalt binder at central mixing plant, to a specified mixing temperature, transporting, spreading and compacting the mixture in an approved manner on primed or tacked base, sub-base, subgrade, bridge deck or concrete pavement in accordance with these Specifications and in conformity with the lines, grades and typical cross-sections shown in the drawings or as directed by the Engineer.

16.4.10.2 Material Requirement

16.4.10.2.1 Mineral Aggregate

- The Aggregates shall consist of coarse aggregates, fine aggregates and filler material, if required and shall be clean, hard, tough, durable and sound particles of uniform quality, geology, petrology and free from decomposed material, vegetable matter, soil, clay, lumps and biller deleterious substances.
- Coarse aggregate which is the material retained on an AASHTO No. 4 Sieve, shall consist of 100% crushed rock or crushed gravel having 2-faces mechanically crushed. The type of source shall be uniform throughout the quarry location from where such a material is obtained. The coarse aggregates shall be free from an excess of fiat or/and elongated particles.
- Fine aggregate which is the material passing from AASHTO No. 4 sieve, shall consist of 100% crushed material from rock or boulder. Fine aggregate shall be stored separately, and no natural sand would be allowed in the mix.
- When the combined grading of the coarse and line aggregates is deficient in material passing the AASHTO No. 200 sieve, mineral filler material shall be added as approved by the Engineer. The filler shall consist of finely divided mineral matter such as rock dust, hydrated lime, hydraulic, calcined dust cement or other suitable mineral matter free from lumps, balls or other deleterious material and shall conform to the following graduation: -

Sieve Designation		Percent Passing by Weight
mm	inch	
0.600	No. 30	100
0.300	No. 50	95-100
0.075	No. 200	70-100

Table 48, Gradation

The coarse and fine aggregates shall meet the following requirements: -

- The percent of wear by the Los Angeles Abrasion Test (AASHTO T-96) shall not be more than 30.
- The loss when subjected to 5-cycles of the Sodium Sulphate Soundness test (AASHTO T-104) shall be less than 12%.
- The Sand Equivalent (AASHTO T-176) determined after all processing except for addition of asphalt cement shall not be less than 45.
- All aggregates shall have a liquid limit of not more than 25 and a Plasticity Index of not more than 4 as determined by AASHTO T-89 and T-90.
- The portion of aggregates retained on the 9.5mm (3/8-inch) sieve shall not contain more than 10% by weight of flat and/or elongated particles (ratio of maximum to minimum dimension = 2.5:1).
- Stripping test shall be performed on crush aggregates as described under AASHTO T-182 and only material shall be allowed which qualifies the test.
- The coarse aggregates shall be checked if desired by the Engineer for cationic and anionic behavior so that their affinity with the bitumen to be used is verified.
- Petrographic examination of the coarse aggregate shall be conducted if so directed by the Engineer.
- The percentage of particles having certain proportions between their largest and smallest dimensions (i.e. between the largest distance the particles can fill out between two parallel planes that would permit the particle to pass), shall be determined in the following way: -
 - Form a sample of coarse aggregates, all particles passing No. 4 sieve are eliminated. The sample shall be of sufficient quantity that at least 100 particles remain.
 - By means of a sliding caliper, the largest and smallest dimensions, as defined above, are determined for each particle and its proportion calculated (with one decimal).
 - The total weights of particles having the proportions 2.5 or less and 3 or less are determined and their percentage in relation to the total sample are calculated.

16.4.10.2.2 Asphaltic Material

Asphaltic binder to be mixed with the aggregate to produce asphaltic base shall be asphalt cement penetration grade 40-50. 60-70 or 80-100 as specified by the Engineer. Generally, it would meet the requirement of AASHTO M-20.

16.4.10.2.3 Asphalt Concrete Wearing Course Mixture

The composition of the asphaltic concrete paving mixture for wearing course shall conform to Class A and/or Class 13 shown in the following table: -

Mix Designation	Class A	Class B
Compacted Thickness	50-80mm	35-60mm

Table 49, Asphalt Concrete Wearing Course Requirements

Sieve Designation	Percent Passing by weight
-------------------	---------------------------

- In addition to meeting the requirements specified in the preceding items, the mixture as established by the JMF shall also satisfy the following physical property.
- Loss of Marshall Stability by immersion of specimen in water at 60°C for 24-hours as compared with the stability measured after immersion of water at sixty 60°C for 20-minutes shall not exceed 20%. If the mixture fails to meet this criterion, the JMF shall be modified or an anti-stripping agent shall be used.
- Shall a change of sources of materials be made a new Job Mix Formula shall be established before the new material is used. When unsatisfactory results or other conditions make it necessary, a new Job Mix Formula would be required.

16.4.10.3 Construction Requirement

Construction requirements for this item shall conform with the same as specified for Asphaltic Concrete Base Course Plant Mix, except as modified in the following sub-items.

16.4.10.3.1 Preparation of Base Course

Before spreading materials, the surface of the previously constructed and accepted base course on which the mix is to be placed shall be conditioned by application of a tack coat, if directed by the Engineer.

16.4.10.3.2 Pavement Thickness and Tolerances

- The asphalt concrete wearing shall be compacted to the desired level and cross slope as shown on the drawing or as directed by the Engineer.
- The tolerances in compacted thickness of the wearing course shall be + 3mm from the desired thickness shown on the drawings. For determination of thickness 1-core per 100m of each lane would be taken. If the thickness so determined is deficient by more than 3mm, but not more than 10mm, payment would be made at an adjusted price as specified in table below.
- The surface of the wearing course shall be tested by the Engineer using 5m straightedge at selected locations. The variation of the surface from the testing edge of the straightedge between any two contacts, longitudinal or transverse with the surface shall at no point exceed 5mm. The cross fall (camber) shall be with + 0.2% or that specified, and the level at any point shall be within + 3mm of the level shown on the Drawings. All humps or depressions exceeding the specified tolerance Shall be corrected by removing the defective work and replacing it with new material, by overlaying, or by other means satisfactory to the Engineer.

16.4.10.3.3 Acceptance, Sampling and Testing

Acceptance of sampling and testing for this item with respect to materials and construction requirements, not specified herein, shall be in accordance with the relevant. "Tables for Sampling and Testing Frequency" in these Specifications.

16.4.10.4 Measurement and Payment

16.4.10.4.1 Measurement

- The quantities of Asphaltic wearing course shall be measured by volume in CM laid and compacted in place. Measurements shall be based on the dimension as shown

on plans or as otherwise directed or authorized by the Engineer. A tolerance of + 3mm shall be allowed in completed thickness of wearing course. However, any asphalt in excess 3mm shall not be paid and any layer deficient by more than 3mm but not exceeding mm shall be paid as per Specifications.

- The quantity of bitumen material used is included in the asphalt concrete mixture and would not be measured separately.
- Quantities of Bitumen or asphalt concrete wasted or remaining on hand after completion of the work shall not be measured or paid for.

16.4.10.4.2 Payment

The quantity determined as provided above shall be paid for at the unit price respectively for each of the particular pay items listed below and shown in the Bill of Quantities, which prices and payment shall constitute full compensation for all the costs necessary for the proper completion of the work prescribed in this item. Asphalt additive or anti-stripping agent, if allowed and used to meet with JMF requirement shall not be paid directly, payment shall be deemed to be included in the respective pay items of Asphaltic wearing course.

Price adjustment: If the thickness determined as per specification is deficient by more than 3mm, but not more than 10 mm, payment will be made at an adjusted price as specified in following Table.

Deficiency in thickness as determined by cores	Proportional Rate of contract price allowed
0.0 mm to 3 mm	100 %
3.1 mm to 5 mm	90%
5.1 mm to 10.0 mm	80%

Table 51, Adjusted Price

When wearing course is more than 10 mm deficient in thickness, the Contractor shall remove such deficient areas and replace them with Wearing course of an approved quality and thickness or the Contractor may opt to place an additional layer of wearing course asphalt, grading with a minimum thickness of 35 mm. The Contractor will receive no compensation for the above additional work. Alternately, the Contractor may choose to overlay the area in a thickness of 30 mm (min.) with smooth transition as approved by the Engineer on either side with no extra compensation.

Pay item no.	Description	Unit of Measurement
16-14-b	Asphaltic Concrete Wearing Course (Class A) 50-80mm thick	M ³
16-14-b	Asphaltic Concrete Wearing Course (Class B) 35-60mm thick	M ³

16.4.11 Asphaltic Concrete Wearing Course (Plant Mix) with Cellulose Fiber

16.4.11.1 Description

The work shall consist of furnishing aggregates, asphalt binder and cellulose fibre at a control asphalt batching plant, mixed at a specified temperature, spreading and compacting the mixture in an approved manner on primed or tacked surface of base, subbase, bridge deck or concrete pavement, in accordance with these specifications and in conformity with lines, grades, typical cross-sections, shown on the drawings or as directed by the Engineer.

16.4.11.2 Material Requirements**1. Mineral Aggregates****a. Coarse Aggregates**

Coarse Aggregates shall be crushed, non-absorptive stones and unless otherwise stipulated, shall conform to the following quality requirements of AASHTO M 283 for class A aggregates:

1. Los Angeles abrasion, AASHTO T 96	30%
2. Flat and Elongated Particles, ASTM D 4791, Comparing length to thickness (measured on material retained above the No. 4 sieve) 2.5: 1	15% max.
3. Sodium sulfate soundness loss (5 cycles), AASHTO T 104	15% max
4. Particles. retained on the No. 4 sieve shall have at least one fractured face, two fractured faces	100% min. 75% min.
5. Absorption, AASHTO T 85	2% max.
6. Coarse and fine durability index, AASHTO T 210	40% max.

Table 52, Requirements of AASHTO M 283 for Class A Aggregate

Mixes with relatively pure carbonate aggregates or any aggregates known to polish shall not be used.

b. Fine Aggregates

Fine aggregate shall consist of a blend of 100 % crushed, manufactured sand. It shall conform to the quality requirements or AASHTO M 20. The sodium sulfate soundness loss in 5 cycles shall not exceed 15 percent in addition, the liquid limit shall not exceed 25 as determined by AASHTO T 89.

c. Combined Aggregates

The several aggregate fractions of course and fine for the mixture shall be sized, graded, and combined in such proportions that the resulting composite blend conforms to Table below.

Sieve Designation		Percentage Passing
3/4 in.		100 %
1/2		85-95
3/8		60-75
No. 4		20-23
No. 8		16-24
No. 30		12-16
No. 50		12-15
No. 200		8-10
0.020 mm	Less than	3*

Table 53, Percentage by Weight Passing Sieves, AASHTO T27 & T 11

* To be controlled from a combination of aggregate and mineral filler taken from representative stockpile samples.

2. Asphalt Cement

- Asphalt Cement shall be AC-20 or similar grade and conform to AASHTO M 226.
- Asphalt Cement shall be mixed at a temperature as required to achieve a kinematic viscosity of 150 to 300 centistokes. Typical plant mixing temperature is 310° - 325 °F and at no time shall the mixing temperature exceed 325 °F.

3. Mineral Filler

- Mineral filler should consist of finely divided mineral mater such as rock or limestone dust or other suitable material. At the time of use it should be sufficiently dry to flow freely and essentially free from agglomerations. Filler should be free from organic impurities and have a plasticity index not greater than 4. Filler material for the mix shall meet the requirements of MSHTO M 17.
- Commercial mineral filler added to the mixture, shall be limited to less than 20% of its weight smaller in size than 0.02 mm.

4. Cellulose Fiber

Fiber stabilizer, cellulose fiber is to be utilized. Dosage rates for cellulose is 0.3 % by weight of the total mix. Allowable tolerances of fiber dosage shall be +/- 10 % of the required fiber weight. The selected fiber shall meet the properties described in Table 6-9.2 utilizing the listed test procedures.

1. Sieve Analysis	
a. Method A – Alpine Sieve Analysis	
Fiber Length:	0.25 (maximum)
Passing No. 100 Sieve	70% (+/- 10%)
b. Method B – Mesh screen Analysis:	
Fiber Length:	0.25 (maximum)
Passing No. 20 Sieve	85% (+/- 10%)
No. 20 Sieve	70% (+/-10%)
No. 20 Sieve	70% (+/-10%)
2. Ash-Content:	18% (+/- non-volatiles)
3. pH:	7.5 (+/- 0)
4. Oil Absorption:	5.0 (+/- 1.0) (Time fibre weight)
5. Moisture Content:	< 5%

Table 54, Cellulose Fiber Properties

a). Method A – Alpine Sieve Analysis

This test shall be performed using as Alpine Air Jet Sieve (Type 200 LS). A representative five-gram sample of fiber shall be sieved for 14 minutes at a controlled vacuum of 22 inches (+/- 3) of water. The portion remaining of the screen shall be weighted.

b). Method-B Mesh Screen Analysis

This test shall be performed using standard No. 20, 40, 60, 80, 100 and 140 sieves, nylon brushes and a shaker. A representative 10-gram sample of fiber shall be sieved, using a shaker and two nylon brushes on each screen. The amount retained on each sieve shall be weighed and the percentage passing calculated. Repeatability of this method is suspect and needs to be verified.

5. Ash Content

A representative 2-3-gram sample of fiber shall be placed in a tarred crucible and heated between 1100°F for not less than two hours. The crucible and ash shall be cooled in a desiccator and reweighed.

6. pH Test

Five grams of fiber shall be added to 100 ml of distilled water, stirred and let set for 30 minutes. The pH shall be determined with a probe calibrated with pH 7.0 buffer.

7. Oil Absorption Test

Five grams of fiber shall be accurately weighed and suspended in an excess of mineral spirits for not less than five minutes to ensure total saturation. It will then be placed in a screen mesh strainer (approximately 0.5 square millimeter hole size) and shaken on a wrist action shaker for ten minutes (approximately 1 - 1/4-inch motion at 240 shakes/minute). The shaken mass shall be then transferred without touching, to a tarred container and weighed. Results shall be reported as the amount (number of times its own weight) the fibers are able to absorb.

8. Moisture Content

Ten grams of fiber shall be weighed and placed in a 250° forced air oven for two hours. The sample will then be reweighed immediately upon removal from the oven.

9. Design Mix Requirements

Design parameter shall be in accordance with Hot Mix Asphalt Design by Marshall Method utilizing AASHTO T-245.

Test	Parameter	Designation
VTM percent	3-4	T-166, T-209, T-269 of total mix.
Asphalt Content %	6.0 min.	
Stability (Kg)	1000 min	Marshall Method
VMA percent	17 min	MS-2
Flow 0.01 inch.	8-14	Marshall Method
Compaction No. of blows on each side of specimen.	50	Marshall Method
Drain Down test, percent.	0.3 max.	

Table 55, Design Mix Requirements

The mix design test property values and cures used to develop the job mix in accordance with the Asphalt Institutes Manual Series No. 2 (MS-2). Acceptable deviations from various values of JMF shall be as under: -

a. Aggregates	
Passing No. 4 and larger sieves	+ 5%
Passing No. 8 No. 100 sieves	+ 3%
Passing No. 200 sieve	+ 1%
b. Asphalt Cement	
Percent by wt. in total mix	+ 0.3%
c. Cellulose Fiber	

Percent by wt. in total mix.	+ 0.03%
------------------------------	---------

Table 56, Acceptable deviation from various values of JMF

16.4.11.3 Construction Requirement

1. Mixing Plant

Plants used for the preparation of the mixture shall conform to AASHTO M 156 and the following.

a. Handling Filler

Adequate dry storage shall be provided for the mineral filler, and provisions shall be made for proportioning the filler into the mixture uniformly and in the desired quantities. Mineral filler in a batch plant will be added directly into the weigh hopper. In a drum plant mineral filler will be added directly into the drum mixer. Special attention is directed to providing appropriate equipment for accurately proportioning the relatively large amounts of mineral filler required for mixture.

b. Fiber Addition

Adequate dry storage shall be provided for the fiber additive, and provisions shall be made for proportioning fiber into the mixture uniformly and in the desired quantities.

c. Batch Plant

Loose fiber or palletized fiber shall be added through a separate inlet directly into the pugmill before adding bitumen in the mix. The addition of fiber should be timed to occur during the hot aggregate charging. Adequate dry mixing time is required to ensure proper blending of the aggregate and fiber stabilizer. Dry mixing time shall be increased 5 to 15 seconds. Wet mixing time shall be increased at least 5 seconds for cellulose fibers to ensure blending with the asphalt cement.

d. Hot - Mixture Storage

When the hot mixture is not to be hauled immediately to the project and placed, suitable bins shall be provided. Such bins shall be either surge bins to balance production capacity with hauling and placing capacity or storage bins which are heated and insulated and which have a controlled atmosphere around the mixture. The holding time shall be within limitations imposed by the Engineer, based on laboratory tests of the stored mixture. In no case will mixture be kept in storage overnight.

2. Hauling Equipment

Hauling equipment and paver shall be of a type normally used for the transport and placement of dense grade asphalt hot mix. Truck beds shall be covered and insulated if necessary, so that the mixture may be delivered on the road at a temperature of not less than 130 °C.

3. Pavers

Pavers shall be a type normally used for the placement of dense graded asphalt hot mix. They shall be self-contained, power-propelled units provided with an adjustable activated screed, heated and capable of spreading and finishing courses of asphalt plant mix material in lane widths applicable to the specified typical section and thickness shown on the plants. The

paver shall be capable of being operated at forward speeds consistent with satisfactory placement and compaction of the mixture. The paver shall be capable of striking a smooth finish of uniform texture.

4. Conditioning of Existing Surface

- Immediately before placing the mixture, the existing surface shall be cleaned of loose or deleterious material by brooming or other approved means.
- A thin tack coat of asphalt emulsion (SS-1, SS-1 h, CSS-1, CSS-1 h or similar material) conforming to AASHTO M 140 or M 208 shall be applied to ensure uniform and complete adherence of the overlay. The asphalt emulsion used for this purpose will be diluted with an equal part of water and be applied at the rate of approximately. 1 gal/square yard.
- Where the existing surface is distorted, a leveling course of hot asphalt mix shall be required to restore proper cross-section prior to construction of the overlay.

5. Facing and Finishing

- The mixture shall be placed at a temperature not less than 290 °F. The mixture temperature shall be measured in the truck just prior to dumping into the spreader.
- The mixture shall be spread and struck off to the established grade and elevation with asphalt pavers.
- Facing speed will be adjusted so that sufficient time is allowed for compaction operations and to provide continuity.

6. Compaction

- Immediately after the mixture has been spread and struck off, it shall be thoroughly and uniformly compacted by rolling.
- Due to the nature of mixture, the surface shall be rolled immediately. Rolling shall be accomplished with steel wheel rollers of a minimum weight of 10 tons. Rolling procedures shall be adjusted to provide the specified pavement density. Rollers shall move at a uniform speed not to exceed 3 mph with the drive roll nearest the paver. Rolling shall be continued until roller marks are eliminated and the minimum density has been obtained. The Contractor shall monitor density during the compaction process by use of nuclear density gauges to assure that the minimum required compaction is being obtained.
- To prevent adhesion of the mixture to the rollers, it shall be necessary to keep the wheels properly moisture with water mixed with very small quantities of detergent or other approved material.
- The pavement shall be compacted to at least 94% of maximum theoretical density and at no more than 6% air voids.
- Once sufficient in-place density has been achieved, rolling operating should cease, as over-rolling may cause migration of asphalt cement and filler to the compacted pavement surface.

7. Quality Assurance

a). Control of Asphalt Mixture

The mixture furnished by the Contractor shall conform to the job-mix formula, within the allowable deviations from the target values. The allowable deviations from the target values for the JMF of the aggregate shall be +/- 4% for the 3/4", 1/2" and 3/8" sieve, +/- 3% for the No. 4, No. 8, No. 30 and No. 50 sieve, and +/- 2% for the No. 200 sieve. The allowable deviation from the target value for the asphalt content shall be +/- 0.3 percent.

b). Trial / Experimental Sections

Test section (s), a minimum of 200 meter each, shall be constructed to examine the mixing plant process control, placement procedures, mix surface appearance, compaction patterns and to calibrate the nuclear density device.

c). Weather Limitations

The mixture shall be placed only when the air temperature is four (4) degrees centigrade or above and no asphalt shall be laid under foggy or rainy weather or over moist surface.

16.4.11.4 Measurement and Payment

16.4.11.4.1 Measurement

The quantities of Asphaltic wearing course shall be measured by volume in CM. laid and compacted in place. Measurements shall be based on the dimension as shown on plans or as otherwise directed or authorized by the Engineer. A tolerance of three (3) mm shall be allowed in compacted thickness of wearing course. However, any asphalt in excess of 3 mm shall not be paid and any layer deficient by more than 3 mm may be rejected unless rectified by overlaying additional layer at no extra cost, approved by the Engineer. The quantity of asphaltic material used is included in the asphalt concrete mixture and will not be measured separately. Quantities Bitumen, wasted or remaining on hand after completion of the work, shall not be measured or paid for. The quantity of cellulose fiber shall be measured in Kg. and paid separately.

16.4.11.4.2 Payment

The quantity determined as provided above shall be paid for at the contract unit price respectively for each of the particular pay items listed below and shown in the Bill of Quantities, which prices and payment shall constitute full compensation for all the costs necessary for the proper completion of the work prescribed in this item.

Pay Item No.	Description	Unit of Measurement
16.4.11.4.2.1	Asphaltic Concrete for Wearing Course of Specified Thickness	SM 100 sft.
16.4.11.4.2.2	Cellulose fiber	SM 100 sft.

16.4.12 Shoulder Treatment

16.4.12.1 Description

This work shall consist of constructing shoulders of the types specified hereinafter in accordance with the Specifications and in conformity to the lines, grades thickness and typical cross-sections shown on the plans or established by the Engineer. Shoulders are defined as that portion of the completed road construction which lies above the elevation of the subgrade or sub-base and which extends from the edge of the wearing course to the point of intersection with the embankment slopes on either side of the road centerline.

16.4.12.2 Material Requirements

16.4.12.2.1 Earth Shoulder

The material used for "Earth Shoulders" shall consist of suitable materials from roadway or structural excavation supplemented by additional suitable material from borrow excavation or as designated on the plans and shall be obtained from sources approved by the Engineer.

16.4.12.2.2 Aggregate Shoulder

Material used for "Aggregate Shoulders" shall be of class designated on the plans and shall conform to all the requirements of 16.3.1 "Granular Sub-base", 16.3.2 "Aggregate Base Course" or 16.3.6 "Water Bound Macadam Base".

16.4.12.2.3 Soil Cement Stabilized Shoulders

Material for soil cement shoulders shall conform to all the requirements of 16.3.4 "Soil Cement Stabilized Sub-base or Base".

16.4.12.2.4 Asphaltic Materials

Materials for surface treatment of shoulders shall be liquid asphalts, emulsified asphalts or asphalt cement as specified or shown on the drawings and in the BOQs. Asphaltic materials shall conform to all the requirements for the type specified.

16.4.12.3 Construction Requirement

16.4.12.3.1 General

All shoulders shall be formed and compacted as soon as practicable after the asphalt paving on the traffic lanes is completed, however in the case of cement concrete surfacing, shouldering operation shall not be initiated prior to Engineer's approval.

16.4.12.3.2 Shouldering and Delineation

On projects that carry traffic through construction, the Contractor shall begin shouldering on the second day of the laying of the final roadway surfacing layer, unless weather conditions prevent this operation, in which case the shouldering shall begin as soon as the weather does permit. If the Contractor fails to begin the shouldering within a reasonable time after the last layer has been laid, whether the project has a flow of traffic through construction or not, the Engineer may order the Contractor to cease paving until the shoulder work has begun. The shouldering shall be a continuous operation from that time on until completion, with the weather being the only delaying factor. The Contractor shall, on roads under traffic or as directed by the Engineer, delineate the edge of pavement as soon as the surfacing is begun and maintain the delineation until the Shoulders are completed. The delineators shall be approved prior to use and shall be placed at the edge of the surfacing at approximately 100m intervals. The cost of this delineation would be considered subsidiary, to other items in the Bill of Quantities and would not be paid for directly.

16.4.12.3.3 Earth Shoulder

Earth shoulders shall be constructed in accordance with the applicable paragraphs under item 108.

16.4.12.3.4 Aggregate Shoulders

Aggregate shoulders shall be constructed in accordance with the requirements of item as shown on the drawings.

16.4.12.3.5 Soil Cement Stabilized Shoulder

Soil cement stabilized shoulders shall be constructed in accordance with the requirements of item.16.3.4 "Soil Stabilized sub-base and Base",

16.4.12.3.6 Asphaltic Treatment of Shoulders

The asphaltic treatment of the prepared shoulders shall be either a bituminous surface treatment or seal coat or a layer of asphaltic concrete as shown on the plans or in the BOQs.

16.4.12.4 Measurement and Payment**16.4.12.4.1 Measurement**

The quantities for shoulder materials and treatment shall be measured and paid for as specified under the particular pay items in the work. The quantities of different items of work shall be added to relative items of the bill of quantities.

16.4.12.4.2 Payment

Pay Item No.	Description	Unit
16.4.12.4.2.1	Formation of Embankment from Roadway Excavation in Common Material	Cub. Ft or CM
16.4.12.4.2.2	Formation of Embankment from Borrow Excavation in Common Material	Cub. Ft or CM
16.4.12.4.2.3	Formation of Embankment from structural Excavation in Common Material.	Cub. Ft or CM
16.4.12.4.2.4	Granular Sub Base.	Cub. Ft or CM
16.4.12.4.2.5	Water Bound Macadam Base Course	Cub. Ft or CM
16.4.12.4.2.6	Asphaltic Base - Plant Mix. Class	Cub. Ft or CM
16.4.12.4.2.7	Cement Stabilized Subbase	Cub. Ft or CM
16.4.12.4.2.8	Cement Stabilized Base	Cub. Ft or CM
16.4.12.4.2.9	Cement content	Ton
16.4.12.4.2.10	Liquid Asphalt for curing seal, type	Ton
16.4.12.4.2.11	Emulsified Asphalt for curing seal, type	Cub. Ft or CM
16.4.12.4.2.12	Bituminous Surface Treatment and Seal Coat.	Sq. Ft or SM
16.4.12.4.2.13	Asphalt Concrete Wearing Course Plant Mix. Class	Cub. Ft or CM

16.4.13 BIT – MAC**16.4.13.1 Description**

This item shall consist of furnishing and mixing aggregates with asphalt binder at site in mobile mixing plant, spreading, compacting on an approved primed subgrade, sub-base or base course, for potholes repair, leveling course and wearing course in accordance with the

Specifications and in conformity with the line, grade, thickness and typical cross-section shown on the Drawings or as directed by the Engineer including sealing of cold bituminous surface cracks with sand-bitumen slurry.

16.4.13.2 Material Requirements

16.4.13.2.1 Mineral Aggregate

Mineral aggregates for BIT - MAC construction shall consist of 'Coarse aggregates, fine aggregate and filler material, all conforming to the Specifications requirements: -

- Coarse aggregate which is the material retained on No. 4 Sieve and Passing 25.4mm sieve, shall consist of crushed rock crushed boulder or crushed gravel. It shall be clean, hard, tough, sound, durable, free from decomposed stones, organic matter, shales, clay lumps or other deleterious substances. Rock or boulders, from which coarse aggregates shall be obtained, must be of uniform quality throughout the quarry location.
- Fine aggregates which are the material passing No. 4 sieve shall consist of crushed sand.
- When combined gradation of coarse and fine aggregates is deficient in material passing No. 200 sieve, mineral filler shall be added. The filler material shall consist of finely divided rock dust from sound rock, hydrated lime or hydraulic cement. At the time of use it shall be sufficiently dry to flow freely, free from lumps.
- Aggregate shall be stored on hard clean surface so as to facilitate prompt inspection and control. Private property shall not be used for storage purposes without written consent of the owner or lessee and payment to him by Contractor if necessary. Material shall be stored in such a way as to prevent segregation and coning to ensure proper control of gradation. The equipment and methods used for stockpiling and removing aggregates shall be such that no degradation of aggregate would result and no appreciable amount of foreign material would be incorporated into the aggregate. When aggregates containing a wide range of sizes are to be incorporated, they must be stockpiled separately to prevent intermingling. Mineral tiller nits.st he protected from moisture to eliminate caking and hardening.

16.4.13.2.2 Bituminous Binder

Asphaltic binder used shall conform standard Specifications of petroleum asphalt having grades 60-70 or 80-100 penetration. Generally, it would meet the requirement of AASHTO T Mater-20

16.4.13.2.3 Design Characteristics

Optimum Grading curves for different types of hot mix asphaltic design related to quantum of repair work and maximum size of aggregates must be carefully selected considering average thickness of patches. Design sheet under table showing Dense Graded Mix used for leveling counts and potholes shall use little asphalt content of such quantity to prevent bleeding through subsequent wearing course or surface treatment. Design is suitable for open graded wearing course having rough Surface texture with good skin resistance thus having minimum bleeding tendency.

16.4.13.3 Construction Requirement

16.4.13.3.1 Mixing Requirement

Asphalt cement shall be heated to a max. temperature of 163 degrees centigrade at the time of mixing. Asphalt cement heated above 163 degrees centigrade shall be rejected. Temperature of asphalt shall be checked frequently. Each aggregate ingredient shall be heated to temperature 150-160 degrees centigrade for at least six' (6) minutes before mixing of asphalt cement to ensure complete drying of aggregates. The range of heating of aggregates shall be strictly followed. to ensure proper coating of aggregates. Fine aggregates shall be introduced into the dryer (mixer) first followed by the coarse aggregates to assure proper mixing. Quantity of aggregates fed to dryer (mixer) must be accurately controlled by suitable measuring device (Iron box) having predetermined volume of one (1) cubic foot or as instructed by Engineer. Both bitumen and aggregates must be heated before they are combined in the mixer drum. Mixing temperature should be kept within the range of 140-170 degrees centigrade. To achieve uniform mixing and proper coating, aggregates and asphalt cement must be thoroughly mixed for a minimum duration of ninety (90) seconds. Mixing time shall be prolonged to hundred (100) seconds if coating of aggregates is not proper. After one hundred and twenty (120) seconds if it is still not possible to get good coating. the aggregate drying time must be increased.

16.4.13.3.2 Deep Patches / Pot Holes

The surfaces of base course thus prepared as mentioned earlier, shall be primed to receive Bit. Mac in a thickness as per drawings or as directed by the Engineer. Bit Mac, shall be spread carefully to avoid segregation. Compaction shall be done with equipment suited to the size of job., A vibratory plate compactor is recommended for small patches. Whereas roller may be more practical for larger areas. Straight edge or string line shall be used to check riding quality and the alignment of the patch.

16.4.13.3.3 Leveling Course

All local depress ions corrugated surface, ripples across the pavement shall be rectified before leveling course is placed. Clean the area free of dust or other loose material with mechanical broom or compressed air. Apply light tack coat, 0.2 to 0.7 liters/m². Of A.C 80/100 penetration grade. After drying dense graded hot Bit-Mac shall be spread in layer not more than 7-cm in thickness. Spread shall be done carefully in prevent segregation and compact with steel wheeled and pneumatic tyred roller. For small pot holes' hand tempers shall be allowed. Use siring line to check the riding quality of the leveling course.

16.4.13.3.4 Wearing Course

16.4.13.3.4.1 Mini Mixing Plant

Local made bitumen aggregate mixer equipment used for preparation of Bit Mac shall be in good working condition. Of sufficient capacity, capable of being operated to produce a uniform blend with the given ingredients.

16.4.13.3.4.2 Preparation of Aggregate

Aggregates shall be stored and handled as discussed earlier under Material Requirement.

16.4.13.3.4.3 Hauling Equipment

Bit-Mac mixed material shall be delivered is tight, clean and smooth metal bed hand trolleys or any method as convenient to the Contractor and approved by the Engineer.

16.4.13.3.4.4 Preparation of Base or Existing Pavement Surface

- Surface of base or existing pavement upon which Bit-Mac mix is to be placed shall be cleaned by means of compressed air to remove dust or is approved by the Engineer.
- Priming shall be done in a manner as described earlier. The rate of application of prime coat shall be 0.8 - 1.5 liter/m². Tack coat shall be done in a manner as described earlier. The rate of application of tack coat shall be 0.2 - 0.4 liter/m². When surface of existing pavement or old base is irregular, it shall be brought to uniform grade and cross-section by leveling course as described above.
- Sand bitumen slurry to seal the cracks in cold bituminous surface shall be injected. pressure pumps with nozzles filled at the end instead of spray pipe in conventional hauler trolley.

16.4.13.3.4.5 Spreading and Finishing

Bit-Mac mixture shall be placed on approved surface, struck off to required section manually with rakes or hand tools by experienced foreman, distributed over the entire width or pallet width as required. All mixtures shall be spread at temperatures not less than 140°C. Mixture shall not be placed on any wet surface or when the atmospheric temperature is below 5°C or when the weather is foggy or rainy.

16.4.13.3.4.6 Compaction

- Roller shall be steel wheel or pneumatic tyred. The roller (s) shall be in good working condition, capable of reversing without backlash, capable to be operated at speeds slow enough to avoid displacement of Bit-Mac. The number and weight of rollers shall be sufficient to compact the mixture while it is still in workable condition to obtain compaction to Engineer's satisfaction. The use of equipment which results in excessive crushing of aggregates shall not be permitted.
- After spreading and strike off as soon as the mix condition permit the rolling to be performed without excessive shoving or tearing, the Bit-Mac mixture shall be, thoroughly and uniformly compacted. Rolling would not be prolonged to avoid appearance of cracks. Rolling would be done longitudinally, beginning at the lower side of the spread and proceeding towards the higher side, overlapping successive trips by of least ½ the width of rear wheels of roller.
- Roller shall be operated at speed slow enough to avoid displacement of mixture. To prevent adhesion of mixture to rollers, the wheels of rollers shall be kept properly moist with water, but avoiding excess water. Rolling shall be continued until all roller marks have been eliminated.
- Along forms curbs, headers, walls and other places not accessible to the roller, the mixture shall be thoroughly compacted with hot hand tampers or mechanical tampers.
- Any mixture that has become cold enough, mixed with dirt or is defective in any way shall be replaced with fresh hot mixture and compacted to conform the requirement.

16.4.13.4 Measurement and Payment

16.4.13.4.1 Measurement

Unless otherwise shown on the plans or as directed by the Engineer, quantity of BIT-MAC shall be measured by theoretical volume of compacted mix, in place, in cubic meters. Measurement would be based on the dimensions as shown on plans or as directed by Engineer. No Measurement would be made for unauthorized areas or for extra thickness than specified. Minimum quantity for pot hole shall be 0.2m³.

16.4.13.4.2 Payment

The accepted quantities measured above shall be paid for at the contract unit price per cubic meters of BIT-MAC for the Pay Item listed below and shown in the Bill of Quantities; which price and payment shall constitute full compensation for slurry seal, priming and tack coat, furnishing all materials, hauling, placing, rolling, labor, equipment, tools and incidentals necessary to complete the item.

Pay Item No	Description	Unit of Measurement
16-13-a, b, c	Dense Graded Hot BIT-MAC	CM
16.4.13.4.2.2	Open Graded Hot BIT-MAC.	CM

16.4.14 Hot Recycling of Asphalt Concrete**16.4.14.1 Description**

This item shall consist of heating and removal of the existing asphalt concrete layer to a designated depth, adding a calculated quantity of asphalt binder adding of freshly prepared asphalt concrete of specified quantity mixing, laying and compaction of properly mixed asphalt concrete in thickness and width as per drawings or a directed by the Engineer.

16.4.14.2 Material Requirements

Materials Specifications for coarse and fine aggregates and asphalt binder shall correspond to the Specifications requirements elaborated under Section 'Asphaltic Sub Base Plant Mix', Section 'Surface Course and Pavement (General)' and Section 'Asphaltic Course Wearing Plant Mix' of this chapter, respectively.

16.4.14.3 Construction Requirement**16.4.14.3.1 Heating of Existing Pavement**

Asphalt pavement shall be heated and softened by pre-beaters or in-built infrared gas fired heaters, to temperature between 140-170°C.

16.4.14.3.2 Scarifying Asphalt Course

Rotating shaft scarifiers fitted with carbide bits shall remove asphaltic course to a depth as specified in drawings or as directed by the Engineer. Scarifiers shall be controlled by electronic devices to ensure removal of materials to a specified depth and grade.

16.4.14.3.3 Mixing of Reclaimed Material

Formula for the admixture would be based on material analysis of existing pavement by bitumen extraction and sieve analysis. Material to be added may be asphalt binder or aggregate, which would be calculated to ensure preparation of proper final mix.

16.4.14.3.4 Addition of Fresh Asphalt Concrete

Fresh asphalt concrete of specified design prepared shall correspond to specifications under Section 'asphaltic Sub Base Plant Mix', and Section 'Asphaltic' Course Wearing Plant Mix' of this chapter and shall be added in proportion to be established as per requirement of line and grades or as directed by the Engineer. This shall be done in conventional way through dumper-hopper arrangement. Fresh material shall be carried by drag-slat conveyor into a second mixer. Exact mixing ratio would be achieved by calibrating the speed of the electronically adjustable drag-slat conveyor to the forward advance speed of the mixer. A second mixer shall ensure homogeneity of reclaimed and fresh asphalt. Engineer shall establish the ratio of fresh and existing asphalt premix to be relayed, before starting this operation. This ratio shall depend upon the quality of existing asphaltic concrete.

16.4.14.3.5 Laying and Compaction

Laying and preliminary compaction of mixed asphalt shall be affected by tamping and vibrating screeds of the recycling equipment. Screeds shall be able to lay the mix true to the levels and grades required by the drawings or as directed by the Engineer. Compaction shall be carried out by conventional equipment to achieve 97% compaction with respect to the laboratory compaction achieved by the mixed asphalt as per Marshall Method.

16.4.14.3.6 General Requirement

Any other physical property essential for workmanship or quality control shall be fixed by the Engineer and Contractor jointly. Physical properties of the fresh material shall correspond to the applicable requirements of such ingredients in this Specification.

16.4.14.4 Measurement and Payment

16.4.14.4.1 Measurement

The quantity of recycled asphalt shall be measured in cubic meters of asphalt concrete removed and relayed after mixing of other ingredients such, as asphaltic binder or fresh wearing course asphalt. Measurement and payment of fresh wearing course asphalt or asphaltic binder shall be made in tons and paid under applicable item of work separately.

16.4.14.4.2 Payment

The quantity measured as provided above shall be paid at the contract unit price per cubic meter as shown in B.O.Q., acceptably laid and compacted in place, which payment shall be deemed to include full compensation for furnishing all materials, Labour, equipment's, tools and incidentals necessary to complete the item. Payment for asphaltic binder or fresh asphalt wearing course shall be made separately under relative item of work as given below.

Pay Item No.	Description	Unit of Measurement
16.4.14.4.2.1	Recycling of Asphalt Concrete (0-60 mm Thick)	CM

16.4.14.4.2.2	Bitumen Binder Grade (40-50, 60-70, 80-100)	Ton
16.4.14.4.2.3	Freshly Prepared Wearing Course Asphalt Concrete of specified quality, mixing, layout and compaction	Ton

16.4.15 Cold Milling

16.4.15.1 Description

This work shall consist of milling (cutting) of concrete or asphaltic layer to a designated level and width by means of Specialized Equipment, removal of cut material and disposal as per special Provision or as directed by the Engineer.

16.4.15.2 Construction Requirement

Specialized equipment to be used for this item of work shall be capable of following operations:

- Milling drum shall be capable of level and grade adjustments and it shall have variable speed provision to ensure production of smooth or rough milled surface.
- Level and grade control shall be ensured through electronic sensors, capable of giving an accuracy of + 2mm.
- Scraper bars and belt conveyer system shall ensure picking and loading of milled material in a truck.

1. Construction Procedure

- Area shall be earmarked with respect to depth of nulling, which shall be split in strips looking to the width of milling drum and width of area to be milled.
- Milling machine shall be adjusted to cut to required depth. Milling drum shall be correlated to sky or string line arrangements to ensure milling according to required grade and profile.
- Milling shall proceed from one edge of the road, strip by strip in a manner that may ensure resulting surface even and level.
- Milled material shall be removed and disposed as per Special Provision or as directed by the Engineer.
- Milled surface shall be cleaned by wire brushes or compressed air for subsequent operation.

16.4.15.3 Measurement and Payment

16.4.15.3.1 Measurement

The quantity of cold milling to be paid shall be measured by the number of square meters of area milled and cleaned as described above, as per drawings or as directed by engineer. No allowance would be given for milling put side approved limit. Any such area milled beyond approved limits, shall be reinstated by the Contractor at his own expense.

16.4.15.3.2 Payment

The accepted quantity measured as provided above shall be paid at the contract unit price per square meter of cold milling for the pay items as listed below and in the B.O.Q., which price and payment shall constitute full compensation for labour, equipment and incidentals necessary to complete the item.

Pay Item No.	Description	Unit of Measurement
16-71-a	Cold Milling 0-30 mm	Square feet
16-71-b	Cold Milling 0-50 mm	Square feet
16-71-c	Cold Milling 0-70 mm	Square feet

16.4.16 Proof Rolling

16.4.16.1 Description

The work shall consist of conducting proof rolling by a specified type of roller to confirm the adequacy of compaction for the underlying layers of an existing road or natural surface. The proof rolling shall be carried out in accordance with these Specifications and in conformation with the lines shown on the drawings or as directed by the Engineer.

16.4.16.2 Construction Requirement

- The proof rolling is to be carried out on any type of granular material, subgrade material or asphaltic layers as the case may be. However, in case, the proof rolling is to be carried out on granular material / subgrade, all the undulations shall be removed by the contractor as a pre-requisite of this item for which payment shall be deemed to be included within this item.
- The equipment required for compaction may be any of the following or combination thereof: -
 - Combination vibratory roller - min. 10 tons capacity.
 - Pad foot vibratory roller - min. 10 tons capacity.
 - Pneumatic type roller 9-wheeler - 21 tons capacity.

16.4.16.3 Measurement and Payment

16.4.16.3.1 Measurement

Proof rolling shall be measured by the unit of square meter in the areas as designated on the drawings or directed by the Engineer.

16.4.16.3.2 Payment

The quantity of completed and accepted work, measured as provided above will be paid at the unit price quoted by the contractor for furnishing all equipment's, Labour, and other items necessary for the completion of the work.

Pay Item No.	Description	Unit of Measurement
16.4.16.3.2.1	Proof Rolling	SM

16.5 Cement Concrete and Concrete Pavements

16.5.1 Concrete

16.5.1.1 Description

This work shall consist of a pavement composed of Portland cement concrete with or without reinforcement as specified constructed on a prepared subgrade or base course in accordance with these Specifications and in conformity with the lines, grades, thickness and typical cross-sections shown on the plans. Both plain and reinforced concrete shall include deformed bars for contraction joints and dowel bars for expansion joints or as shown on the drawings.

16.5.1.1.1 Classes of Concrete

- The classes of concrete recognized in these Specifications shall be designated: A1, A2, A3, B, C, D1, D2, D3, Y and Lean Concrete. The Class of concrete to be used shall be as called for on the Drawings or as directed by the Engineer or specified in the Special Provisions. The following requirements shall govern unless otherwise shown on the Drawings.
- Class A1 concrete shall be used everywhere, for non-reinforced and reinforced concrete structures, except as noted below or directed by the Engineer.
- Concrete placed under water shall be Class A2 with a minimum cement content of three hundred fifty (350) kg/cu m 22ls/cft of concrete with a slump between ten (10) / 4" and fifteen (15) cm /6".
- Concrete placed for piles shall be class A3 with minimum cement content of four hundred (400) kg/cu m 24.3 lbs. / cft.
- Class B concrete shall be used only where specified.
- Class C concrete shall be used for cribbing, or as otherwise directed by the Engineer or specified in the Special Provisions or on the Drawings.
- Class D1, D2 or D3 concrete shall be used for pre-stressed and post-tensioned elements, as indicated on the Drawings.
- Class Y concrete shall be used as a filler in steel grid bridge floors, in thin reinforced sections, or as otherwise specified in the Special Provisions.
- Lean Concrete (Plain Cement concrete) shall be used in thin layers underneath footings and when called for on the Drawings or directed by the Engineer.
- The recommended limits of Module of course aggregate for all concrete classes would be ranges 6.95 ~ 7.6 Kg/m³ except class whose module range is 6.3 to 6.9.
- The concrete of the various classes shall satisfy the requirements shown in Table.

Class of Concrete	Mix. Design ratio (Tentative)	Max. Size of Coarse Aggregate (mm)	Min. Cement (Kg/m ³)	28 days' Compressive Strength (min) (Cylinder)		Consistency (Range in Slump) Vibrated (mm)	Permissible Maximum Water- Cement Ratio
				Psi	(Kg/cm ²)		
A1	1:2:4	20	300	3000	210	25~75	0.58
A2	1:1.5:3	25	350	3500	245	100~150	0.58
A3	1:1.5:3	38	400	4000	280	100~150	0.58
B	1:3:6	51	250	2400	170	25~75	0.65
C	1:2:4	38	275	3000	210	25~75	0.58

D1	1:1:2	25	450	5000	350	50~100	0.40
D2	1:1:2	25	500	6000	425	50~100	0.40
D3	1:1:2	25	550	7000	500	50~100	0.40
Y	1:2:4	13	400	3000	210	25~75	0.58
Lean Concrete	1:4:8	51	175	1400	100	-	-

Table 57, Portland Cement Concrete Requirements

16.5.1.1.2 Types of Concrete Works

1. Under Ground Concrete

Concrete poured below Natural Surface Level with or without shuttering and shoring.

2. On Ground Concrete

Concrete poured by erecting formwork with necessary bracings on ground.

3. Elevated Concrete

Concrete poured by erecting props, bracing and towers to support the formwork at higher levels.

16.5.1.2 Material Requirements

16.5.1.2.1 Portland Cement

- Cement remaining in bulk storage at the mill, prior to shipment, for more than six months or cement stored in local storage by Contractor for more than three months after shipment from the factory may be retested before use and shall be rejected if it fails to meet any of the Specification requirements.
- Portland cement shall conform to the requirements of the Standard Specifications for Portland cement, AASHTO Designation M85 (ASTM Designation C150). The type of the cement to be used, unless otherwise shown on the Drawings, shall be type I.
- Sampling of cement shall be in accordance with AASHTO Designation T-127.
- Mill certificates shall accompany delivery of the material to the work.
- Cement shall be delivered in sufficient quantities to ensure that there is, no suspension of the work of concreting at any time. Different brand or different types cement from the same mill, or the same brand or type from different mills shall not be mixed or used alternately in the Same item of construction unless authorized, by the Engineer; after preparing new mix design.

16.5.1.2.2 Fine Aggregate

- The fine aggregate shall consist of sand, stone screenings or other approved inert materials with similar characteristics, or a combination thereof having clean, hard, strong, durable, uncoated grains free from injurious amount of dust, lumps, soft or flaky particles, shale alkali, organic matter, material reactive with alkalis in the cement loam or other deleterious substances, and shall not contain more than three percent of material passing the No. 200 sieve by washing not more than one percent of clay lumps of one percent shale. The use of beach sand is prohibited without the written consent of the Engineer.

- For exposed work, the fine aggregate shall be free from any substance that would discolor the concrete surface.
- The fine aggregate shall be uniformly graded and when tested in accordance with AASHTO Designation T-11 and T-27 shall meet the following grading requirements.

Sieve Designation	Percentage Passing by Weight
3 / 8 inch (9.5mm)	100
No. 4 (4.75mm)	95~100
No. 16 (1.18mm)	45~85
No. 50 (0.3mm)	10~30
No. 100 (0.15mm)	2~10
No. 200 (0.075mm)	0~3

Table 58, Grading of Fine Aggregates

- In case if fine aggregates fail under Fineness Modulus or Gradation however material passing No. 4 in combined aggregate, qualifies for these requirements, then the material can be accepted.
- Fine aggregates shall be of such quality that mortar specimen's, prepared with standard Portland cement and tested in accordance with AASHTO Designation T-71, shall develop a compressive strength at 7 days of not less than 90 percent of the strength developed by a mortar prepared in the same manner with the same cement and graded sand having a fineness modulus of 2.3. to 3.1. Natural aggregates if required shall be thoroughly and uniformly washed before-use. Sand equivalent (T-176) shall be 75 min.
- For the purpose of determining the degree of uniformity, a fineness modulus determination shall be made upon representative samples submitted by the Contractor from such sources as he proposes to use. Fine aggregate from any one source having a variation in fineness modulus of greater than 0.20 either way from the fineness modulus of mix design samples submitted by the Contractor may be rejected till new trial mixes are prepared and tested by the Contractor.

16.5.1.2.3 Coarse Aggregate

- The coarse aggregate shall consist of crushed or broken. Stone, gravel or other approved inert materials with similar characteristics, or a combination thereof having clean, hard, strong, sound, durable uncoated particles, free from injurious amount of soft, friable, thin elongated, or laminated pieces, alkali, organic or other deleterious matter and conforming to the requirements of these Specifications.
- The coarse aggregate shall be of uniform grading with maximum sizes as required for the various classes of concrete as shown in Table below and when tested in accordance with AASHTO Designation T-11 & T-27 Shall meet the following grading requirements.

Designated Sizes	Percentage by Weight Passing Laboratory Sieves, in inches, Having Square Openings							
	2 ½	2	1 ½	1	¾	½	3/8	No. 4
½" to No. 4	-	-	-	-	100	90~100	40~70	0~15*
¾" to No. 4	-	-	-	100	90~100	-	20~55	0~10*
1" to No. 4	-	-	100	95~100	-	25~60	-	0~10*

1½" to No. 4	-	100	95~100	-	35~70	-	10~30	0~5
2" to No. 4	100	95~100	-	35~70	-	10~30	-	0~5
1½" to ¾"	-	100	90~100	20~55	0~15	-	0~5	-
2" to 1"	100	90~100	35~70	0~15	-	0~5	-	-

Table 59, Grading of Coarse Aggregate

*Not more than five percent shall pass No .8 sieve.

- Coarse aggregate shall contain no more than one percent by weight of material passing the No. 200 sieve by washing and not more than five percent of soft fragments.
- It shall have an abrasion loss of not more than forty percent at five hundred revolutions, when tested in accordance with AASHTO T-96.
- When tested in accordance with AASHTO T-104, for five cycle, the loss with the sodium sulphate soundness test shall be not more than 12 percent.
- Natural aggregates shall be thoroughly washed before use. Testing of coarse aggregate is specified under relevant section in Chapter-6 "CONCRETE" and hereafter under Section "STRUCTURES" of this chapter.
- The aggregate shall be non-alkali/silica reactive where the concrete is to be poured under water or exposed to humid conditions. In- case the Contractor proposes to use the aggregate having the alkaline/siliceous characteristics with the- intention to use- it with Blast Furnace Slag Cement, he would undertake to carry out the job, without any extra cost and shall arrange to conduct the necessary tests as directed by the Engineer.

16.5.1.2.4 Combined Aggregate

The coarse and fine aggregate shall be combined in the proportions according to the approved trial mixes for each Class of concrete.

16.5.1.2.5 Water

- The water for curing, for washing aggregates and for mixing shall be subject to the approval of the Engineer. It shall be free from oil and shall contain no more than one thousand parts per millions of chlorides nor more than one thousand per million parts per million of sulphate (SO₄). In no case shall the water contains an amount of impurities that would cause a change in the setting time of Portland cement of more than twenty-five percent nor a reduction in the compressive strength of mortar at fourteen days of more than five percent when compared to the result obtained with distilled water.
- In non-reinforced concrete work, the water for curing, for washing aggregates, and for mixing shall be free from oil and shall not contain more than two thousand parts per millions of chlorides nor more than one thousand five hundred parts per million of sulphate as SO₄.
- In addition to. the above requirements; water for caring concrete shall not contain any impurities in a sufficient amount to cause discoloration of the, concrete or produce etching of the surface.
- When required by the Engineer, the quality of the mixing water shall be determined by the Standard Method of Test for Quality of Water to be used in concrete, AASHTO Methods of Sampling and Testing, Designation T 26.

16.5.1.2.6 Admixture

Admixtures shall only be allowed to be used with written permission from the Engineer. If air entraining agents, water reducing agents, set retarders or strength accelerators are permitted to be used, they shall not be used in greater dosages than those recommended by the manufacturer, or permitted by the Engineer and shall conform to the requirements for each of the agents specified by the manufacturer.

16.5.1.2.7 Rubble or Cyclopean Concrete

Rubble or cyclopean concrete shall consist of tough, sound and durable rock. The stone shall be free from coatings, seams or flaws of any character. In general; the percentage of wear shall not exceed fifty when tested in accordance with the Standard Method of Testing for Abrasion of Coarse Aggregate by the use of the "Los Angeles Machine", ASTM C535.

16.5.1.2.8 Storage of Cement and Aggregate

- All cement shall be stored, immediately upon arrival on the site of the work, in weatherproof building, which would protect the cement from dampness. The floor shall be raised from the ground. The buildings shall be placed in locations approved by the Engineer. Provisions for storage shall be ample; and the shipments of cement as received shall be separately stored in such a manner, as to provide easy access for identification and inspection of each shipment. Storage buildings shall have capacity of a sufficient quantity of cement for at least thirty days' use. Bulk cement, if used, shall be transferred to elevated air tight and weather-proof, bins. However, if approved, sacked cement on small jobs may be stored in the open upon a raised platform provided that ample waterproof covering is ensured. Stored cement shall meet the test requirements at any time after storage when retest is ordered by the Engineer. At the time of use all cement shall be free flowing and free of lumps. Cement bags shall be weighed at random to check for variation.
- Copies of cement records shall be furnished to the Engineer showing such detail as, the quantity used during the day run or at each part of the work. Cement held in storage for a period of over sixty days, or cements which, for any reason the Engineer may suspect of being damaged, shall be subject to a retest before being used in the work.
- The handling and storing of concrete aggregates shall be such as to prevent segregation or the inclusion of foreign materials. the Engineer may require that aggregates be stored on separate platforms at satisfactory locations.
- In order to secure greater uniformity of the concrete mix, the Engineer may require that the coarse aggregate be separated. into two or more sizes. Different sizes of aggregate shall be stored in separate bins or in separate stock piles to prevent the material at the edges of the piles from becoming intermixed.
- If aggregates are stored on the ground the bottom layer of aggregate shall not be disturbed or used without reclining and as approval by the Engineer.

16.5.1.3 Construction Requirement

The manufacturing, transport, handling and placing of concrete shall conform with the requirements given hereinafter. Unless otherwise specified, ordinary Portland cement shall be used for all types of concrete. When sulphate resisting cement or other type of cement is required, it would be specified on the Drawings/or in Bill of Quantities or ordered by the Engineer.

16.5.1.3.1 Proportioning of Concrete

- All concrete shall be proportioned by weighing, except as specified herein. The proportions by weight of cement, fine aggregates, coarse aggregates and water necessary to produce concrete of the required strength and consistency shall be approved by the Engineer. Such approval may be withdrawn at any time, and changes in the proportions may be required for the purpose of required workability, density, impermeability; durability and strength.
- Based on the approved mix proportions, the Contractor shall prepare lists showing the number of kg of the various material to be used in the batch size adopted. The required consistency shall also be shown. Such lists are subject to approval by the Engineer, and shall be posted at the mixer. The amount of water in the mix is the total amount of free water, including the free water held by the aggregates.
- No Concrete shall be placed in the works until the results of the twenty-eight days' test indicate that the design proportions are satisfactory as per requirements under item "Testing of Compressive Strength". Adjustment of the proportions shall be subject to the following provisions.
- Adjustment for variation in workability - if it is found impossible to obtain concrete of the desired workability with the proportions originally approved, the Engineer shall make such changes as are necessary.
- Adjustment of new material - No change in the source or character of the material shall be made without due notice to the Engineer and no new materials shall be used until the Engineer has accepted such materials and has approved new proportions based on trial mixes.
- The Contractor's attention is drawn to the time required to prepare and test trial batches and the Contractor shall be responsible for production of trial batches at a sufficiently early date so that the progress of the work is not delayed.

16.5.1.3.2 Consistency

- Concrete shall have a consistency such that it would be workable in the required position. It shall be of such a consistency that it would flow around reinforcement steel but individual particles of the coarse aggregate when isolated shall show a coating of mortar containing its proportionate amount of sand. The consistency of concrete shall be determined to be as dry as it is practicable to satisfy the requirements for transportation and placing of the concrete as described hereinafter.
- Consistency of concrete shall be determined as specified in AASHTO T-119. The consistency of concrete at the time of delivery shall be as shown in Table above or as designated by the Engineer.

16.5.1.3.3 Water Cement Ratio

The quantity of water introduced into mixes shall be regulated and arranged so as to ensure that the water-cement ratio shall be the minimum required to produce the concrete specified. In general, the mix design shall provide for water-cement ratios by weight with aggregate at saturated surfaces dry condition, which will be determined on the basis of producing concrete having suitable workability, density, impermeability, durability and the required strength without the use of excessive amount of cement. The maximum permissible water cement ratio for each concrete class is shown in Table of 16.5.1.1.1.

16.5.1.3.4 Mixing Concrete

1. Mixing General

- The concrete shall be mixed only in the quantity required for immediate use. Concrete that has developed an initial set shall be rejected.
- Concrete shall be thoroughly mixed in a mixer of an approved size and type that would ensure a uniform distribution of the materials throughout the mass.
- All concrete shall be mixed in mechanically operated mixers. Mixing plant and equipment for transporting and placing concrete shall be arranged with an ample - auxiliary installations to provide a minimum supply of concrete in case of breakdown of machinery or in case the normal supply of concrete shall be disrupted. The auxiliary supply of concrete shall be sufficient to complete the casting of a section up to a construction joint.
- Equipment having components made of aluminum or magnesium alloys, which would have contacted with plastic concrete during mixing, transporting or pumping of Portland, cement concrete, shall not be used.
- Concrete mixers shall be equipped with adequate water storage and a device for accurately measuring and automatically controlling the quantity of water used.
- Materials shall be measured by weighing, except as otherwise specified or where other methods are specifically authorized by the Engineer. The apparatus provided for weighing the aggregates and cement shall ensure accurate measurement, of each ingredient.
- The accuracy of all weighing devices except that for water shall be such that successive quantities can be measured to within one percent of the desired value, cement in standard packages (bags) approved by the Engineer need not be weighed. The water measuring device shall be accurate to plus or minus half percent $\pm 0.50\%$. All measuring devices shall be subject to the approval of the Engineer. Scales and measuring devices shall be tested at the expense of the Contractor as frequently as the Engineer may deem necessary to ensure their accuracy.
- Weighing equipment shall be isolated so that vibration or movement of other operating equipment does not affect the accuracy of reading. When the entire plant is running, the scale reading at cut off shall not vary from the weight designated by the Engineer more than one percent for cement, one and half percent for any size of aggregate or one percent for the total aggregates in any batch.
- Where volumetric measurements are authorized by the Engineer, the weight proportions shall be converted to equivalent volumetric proportions. In such cases, suitable allowances shall be made for variations in the moisture condition or the aggregates, including of the bulking effect in the fine aggregate. Boxes or similar containers of the exact volume required shall be filled and struck off. Measurement by wheel barrow, volumes would not be permitted.

2. Mixing at Site

- Concrete mixers may be of the revolving drum or the revolving blade type and the mixing drum or blades shall be operated uniformly at the mixing speed recommended by the manufacturer. The pick-up and throw-over blades of mixer shall be restored or replaced when any part or sections is worn two and half cm or below than the original height of the manufacturer's design. Mixers and agitators, which have an accumulation of hard concrete or mortar shall not be used.

- When bulk cement is used and volume of the batch is one cubic meter or more, the scale and weigh hopper for Portland cement shall be separate and distinct from the aggregate hopper or hoppers. The discharge mechanism of bulk cement weigh hopper shall be interlocked against opening before the full amount of cement is in the hopper. The discharging mechanism shall also be interlocked against opening when the amount of cement in the hopper is underweight by more than one percent or overweight by more than three percent of the amount specified.
- When the aggregates contain more water than the quantity necessary to produce a saturated surface-dry condition, representative samples shall be taken and the moisture content determined for each kind of aggregate.
- The temperature of mixed concrete, immediately before placing, shall be not more than, thirty, two-degree C. Aggregates and water shall be cooled as necessary to produce concrete within this temperatures limit. If ice is used to cool the concrete, discharge of the mixer would not be permitted until all ice is melted.
- The batch shall be so charged into the mixer that some water would enter in advance of cement and aggregates. All water shall be in the drum by the end of the first quarter of the specified mixing time.
- Cement shall be batched and charged into the mixer by means that, would not result in loss due to the effect of wind, or in accumulation of cement on surfaces of conveyors or hoppers, or in other conditions which reduce or vary the required quantity of cement in the concrete mixture.
- The entire contents of a batch mixer shall be removed from the drum before materials for a succeeding batch are placed therein. The materials composing a batch except water shall be deposited simultaneously into the mixer.
- All concrete shall be mixed for a period of not less than one and half minutes after all materials; including water, are in the mixer. During the period of mixer shall mixer shall operate at the speed for which it has been designed.
- Mixers shall be operated with an automatic timing device that can be located by the Engineer. The time device and discharge mechanism shall be so interlocked that during normal operation no part of the batch would be discharged until the specified mixing time has elapsed. In case of failure of the timing device, the Contractor would be permitted operate while it is being repaired, provided the furnishes an approved timepiece equipped with minute and second hand. If the timing device is not repaired within 24-hours, further use of the mixer would be prohibited until repairs are made.
- The final batch of concrete material placed in the mixer shall contain cement, sand and water in excess to the requirement of mix. to ensure that the drink does not extract mortar from the mix changing its design characteristics. When mixing is to stop for a period of one hour or more, the mixer shall be thoroughly cleaned.

3. Plant Mix

- At central mixing plant, batches shall be discharged from the weighing hopper into the mixer either directly by gravity or by an elevating container large enough to contain the batch. The plant shall be arranged to ensure that there is no loss of cement during transfer from weighing hopper to the mixer drum. The mixing time shall neither be less than fifty second, nor more than ninety seconds.
- The plasticizer, accelerator or retarded or water reducing admixture, if required, shall be fed separately at the rate recommended by the manufacture, or as established by laboratory trials.

4. Transit Mixing

- Truck mixers, unless otherwise authorized by the Engineer: shall be of the revolving drum type, watertight, and so constructed that the concrete can be mixed to ensure a uniform distribution of materials throughout the mass. All solid materials, or the concrete shall be accurately measured and charged into the drum at the proportioning plant. The truck mixer shall be equipped with a device by which the quantity of water added can be readily verified. The mixing water may be added directly to the batch, in case of the concrete batch is poured within twenty five minutes (adding water).
- The maximum size of batch in truck mixers shall not exceed the maximum rated capacity of the mixer, as stated by the manufacturer, and stamped in metal on the mixer. Truck mixing shall be continued for not less than fifty revolutions tiller all ingredients; including water, and in the drum; the mixing speed shall not be less than six rpm not more than ten rpm.
- Mixing shall begin within thirty minutes after the cement has been added either to the water or aggregate, but when cement is charged into a mixer drum containing water or surface-wet aggregate and when the temperature is above thirty-two-degree C, this limit shall be reduced to fifteen minutes. The limitation item between the introduction of the cement to the aggregate and the beginning of the mixing may be waived when the judgment of the Engineer, the aggregate is sufficiently free from moisture, so that there still be no harmful effects on the cement.

5. Partial Mixing at the Central Plant

When a truck mixer, or an agitator provided with adequate mixing blades, is used for transportation, the mixing time at the stationary plant mixer may be reduced to thirty seconds and the mixing completed in a truck mixer/agitator. The mixing time in the truck mixer or agitator equipped with adequate mixing blades shall be as specified for truck mixing.

6. Stiff Concrete Mix

For mixing concrete of zero slumps to be laid by paver, gravity mixer shall not be used. Only force mixer of moving blades shall be allowed to ensure homogeneous mix.

7. Hand Mixing

Hand mixing of materials shall not be allowed in any case.

8. Temperature Control

No mixing or pouring of concrete will be allowed at ambient temperatures higher than 35 °C, without prior approval of the Engineer for satisfactory measures made by the Contractor for keeping the concrete mix cool at the time of placing. The temperature of mixed concrete immediately before placing shall not be more than 30 °C. The Contractor shall take all specific precautions according to AASHTO-SS-Division II 8.6.3 to achieve this target for which no extra payment shall be made.

16.5.1.3.4.1 Hauling and Delivery of Mixed Concrete

1. Hauling

- Mixed concrete may be transported to the delivery point in truck agitators or truck mixers operating at the speed designated by the manufacturer, provided the consistency workability of the mixed concrete Upon discharge at the delivery point in suitable for adequate placement and consolidation in place.
- Truck agitators shall be loaded not to exceed the manufacturer's rated capacity; they shall maintain the mixed concrete in a thoroughly. mixed and uniform mass during hauling.
- Bodies of non-agitating hauling equipment shall be so constructed that leakage of the concrete mix, or any part thereof, would not occur at any time, and they shall be self-cleaning during discharge.
- For zero slump concrete to be laid be paver, concrete would be allowed to be hauled in open trucks. However, concrete hauled in open-top vehicles shall be protected, during hauling against rain, or exposure to the sun for more than twenty minutes when the ambient temperature exceeds twenty-five degrees centigrade.
- No additional water shall be incorporated into the Concrete during hauling or after arrival at the delivery point.
- The rate of discharge of mixed concrete from truck mixer agitators shall be controlled by the speed of rotation of the drum in the discharge direction with the discharge gate fully open.
- When a truck mixer or agitator is used for transporting concrete to the delivery point, discharge shall be completed within one hour or before two hundred fifty revolutions or the drum or blades, whichever comes first, after the introduction of cement to the aggregates. Under conditions contributing to quick stiffing of the concrete, or when the temperature of the concrete is thirty degrees centigrade or above a time less than one hour would be required except when retarder is used in which case it shall be one hour.
- When non-agitating hauling equipment is used for transporting concrete to the delivery point, discharge shall be completed within One how after the addition of the cement to the aggregates. Under conditions contributing to quick stiffening of the concrete, or when the temperature of the concrete is thirty degrees centigrade or above the time between the introduction of cement to the aggregates and discharge shall not exceed forty-five minutes.

2. Delivery

The organization supplying concrete shall have sufficient plant capacity and transportation vehicles to ensure continuous delivery at the rate required. The rate of the delivery, of concrete during concreting operations shall be such as to provide for the proper handling, placing, and finishing of the concrete. The rate shall be such that the interval between batches shall not exceed twenty minutes. The method of delivering and handling the concrete shall be such as would facilitate placing with the minimum re-handling and without damage to the structures of the concrete.

3. Retempering

The concrete shall be mixed only in such quantities as are required for immediate use and any concrete that has developed initial set shall not be used. Concrete that has partially hardened shall not be re-tempered or remixed.

16.5.1.3.5 Handling and Placing of Concrete

1. General

- In preparation for the placing of concrete all sawdust, chips and other construction' debris and extraneous after shall be removed from inside the formwork; and struts, stays and braces serving temporarily to hold the forms in correct shape and alignment, pending the placing of concrete at their locations, shall be removed when the concrete placing has reached an elevation rendering their services unnecessary. These temporary members shall be entirely removed from the forms and not buried in the concrete.
- No Concrete shall be used that does not reach its final position in the forms within this time stipulated above in "Hauling and Delivery of Mixed Concrete".
- Concrete shall be placed so as to avoid segregation of the materials and the of the reinforcement. The use of long troughs, chutes, and pipes for conveying concrete to the forms shall be permitted only on written authorization of the Engineer. In any case the Engineer would reject the use of equipment for concrete transportation that would allow segregation, loss of fines, or in any other way would have a deteriorating the concrete quality.
- Open troughs and chutes shall be of metal or metal lined; where steep slopes are required, the chutes shall be equipped with baffles or be in short lengths that reverse the direction of movement.
- All. alums. troughs and pipes shall be kept clean and free from coatings of hardened concrete by thoroughly flushing with water after each run; water used for flushing shall be discharged clear off the structures.
- When placing operations would involve dropping the concrete more than one and half meters, it shall be conveyed through sheet metal or other approved pipes. As far as practicable, the pipe shall be kept buried in the newly placed concrete. After initial set of the concrete the forms shall not be jarred and no loading of any kind shall in place on the ends of projecting reinforcement bars.
- The concrete shall be placed as nearly as possible to its final-position and the use of vibrators for extensive shifting of the mass of fresh concrete would not be permitted.

2. Pneumatic Placing

- Pneumatic placing of concrete would he permitted only if authorized by the Engineer. The equipment shall be so arranged that no vibration would occur that might damage freshly placed concrete.
- Where concrete is conveyed and placed by pneumatic inertias; the equipment shall be suitable in kind and adequate in capacity for the work. The Machine shall be located close as practicable to the work. The discharge lines shall he horizontal or inclined upwards from the machine.
- At the conclusion of placing the concrete the entire equipment shall be thoroughly cleaned.

3. Pumping

- The placing of concrete by pumping would be permitted only if specified in the Special Provisions or if authorized by the Engineer. The equipment shall be so arranged that no vibration would occur that might damage freshly placed concrete.
- Where concrete is conveyed and placed mechanically applied pressure the equipment shall be suitable in kind and adequate in capacity for the work. The operation of the pump shall be such that a continuous stream of concrete without air pockets is obtained. When pumping in completed, the concrete remaining in the pipeline, if it is

to be used, shall be ejected in such a manner that there would be no contamination of the Concrete of separation of the ingredients. After this operation the entire equipment shall be thoroughly cleaned.

4. Placing Concrete Under Water

- Concrete shall not be placed under water except where inevitable in which case approval must be sought from the Engineer and the work carried out under his immediate supervision. In this case the method of placing shall be as hereinafter specified.
- Concrete deposited under water shall be class A concrete with a minimum cement content of three hundred fifty Kg per cubic Meter of concrete.
- The slump of concrete shall be maintained between ten and fifteen cm. To prevent segregation, it shall be carefully placed. In a compact mass, in its final position, by means of a tremie, a bottom-dump bucket, or other approved means, and it shall not be disturbed after being placed. Water must not be allowed to flow past the fresh concrete surface.
- A tremie shall consist of a tube having a diameter of not less than 25cm constructed in sections having couplings fitted with gaskets with a cap at the top. The tremie shall be supported so as to permit free movement of the discharge end over the entire top surface of the work and so as to permit rapid lowering when necessary to retard or stop the flow of concrete. The discharge end shall be closed at the start of work so as to prevent water entering the tube and shall be completely submerged in concrete at all times; the tremie tube shall be kept full to the bottom of the hopper. When a batch is dumped into the hopper, the flow of concrete shall be induced by slightly raising the discharge end, but always keeping it in the placed concrete. The flow shall be continuous until the work is completed.
- When the concrete is placed with a bottom-dump bucket; the top of the bucket shall be open. The bottom doors shall open freely downward and outward when tripped. The bucket shall be completely filled and slowly lowered to avoid backwash. It shall not be dumped until it rests on the surface upon which the concrete to be deposited and when discharge shall be withdrawn slowly until well above the concrete.
- Dewatering may proceed when the concrete seal is sufficiently hard and strong. All laitance or other unsatisfactory material shall be removed from the exposed surface by; scraping, chipping or other means, which would not injure the surface of the concrete.

5. Compaction

- Concrete, during and immediately after placing shall be thoroughly, compacted, except lean concrete footings and concrete deposited under water. Concrete in walls, beams, columns, etc: shall be placed in horizontal layers to more than thirty cm thick except as hereinafter provided. When less than a complete layer is placed in one operation; it shall be terminated in a vertical bulkhead. Each layer shall be placed and compacted before the preceding layer has taken initial set to prevent injury to the 'green concrete and avoid surfaces of separation between the layers. Each layer shall be compacted so as to avoid the formation of a construction joint with a preceding layer, which has not taken an initial set.
- The compaction shall be done by mechanical vibration. The concrete shall be vibrated internally unless special authorization of other methods is given by the Engineer or is provided herein vibrators shall be of a type, design, and frequency approved by the

Engineer. The intensity of vibration shall be such as visibly to affect a mass of concrete with a 3cm slump over a radius of lit least hat it meter. The Contractor shall provide a sufficient number of vibrators to properly compact each batch immediately after it is placed in the forms. Vibrators shall be manipulated so as to thoroughly work the concrete around the reinforcement and embedded fixtures and into the corners and angles of the form and shall be applied, at the' point of placing and in the rates of freshly placed concrete. The vibrators shall. be inserted into and withdrawn from the concrete slowly: The vibration shall be of sufficient duration. and intensity to compact the 'concrete thoroughly but shall not be continued at anyone point to the extent that extent that localized areas of grout are formed. Application of vibrators shall be at points uniformity spaced and not further apart Lima twice the radius over, which the vibration is visibly effective. Vibration shall not be applied directly to tie reinforcement or to sections or layers of concrete that have hardened to the degree that the concrete ceases to be plastic Under vibration. It shall not be used to make concrete flow in the forms over distances so great as to cause segregation and vibrators shall not be used to transport concrete neither in the form nor in troughs or chutes.

- Vibration shall be supplemented by such external vibrator as is necessary to ensure smooth surfaces and dense concrete along form surfaces and-in comers and locations impossible to reach with the normal vibrators.

16.5.1.3.6 Casting Sections and Construction Joints

1. General

The concrete in each integral part of a structure shall be placed continuously and the Contractor will not be allowed to commence work on any such part unless sufficiently inspected and approved material for the concrete is at hand and manpower and equipment are sufficient to complete the part without interruption in the placing of the concrete. Construction joints shall be allowed only where specified on the plans or otherwise approved. If not detailed on the plans, or in the case of emergency, construction joints shall be placed as directed. Shear keys or inclined reinforcement shall be used where necessary to transmit shear or bond the two sections together. When shear keys or inclined reinforcement are not provided, the concrete shall be roughened as directed. Joints in the concrete due to discontinuity of work shall be avoided as far as possible. Such joints, when necessary, shall be constructed to meet the approval of the Engineer. When the placing of concrete is temporarily discontinued, the concrete after becoming firm enough to retain its shape, shall be cleaned of laitance and other objectionable material to a sufficient depth to expose sound concrete. Where a "feathered edge" might be produced at a construction joint, as in the sloped top surface of a wing wall, an inset formwork shall be used to produce an edge thickness of not less than fifteen (15) cm 6" in the succeeding layer. Work shall not be discontinued within fifty (50) cm 20" of the top of any face, unless provision has been made for a coping less than fifty (50) cm 20" thick, in which case, if permitted by the Engineer, the construction joint may be made at the underside of coping. Immediately following the discontinuance of placing concrete all accumulations of mortar splashed upon the reinforcing steel and the surfaces of forms shall be removed. Dried mortar chips and dust shall not be puddled into the unset concrete. Care shall be exercised, during the cleaning of the reinforcing steel, not to injure or break the concrete steel bond near the surface of the concrete.

2. Slab Culverts

In general, the lean concrete below the foundation shall be placed and allowed to set before the reinforced concrete is started. After the construction of masonry abutment walls, as specified in Special- Provisions, the concrete bed plate and curtain walls shall be constructed

monolithically. Construction joints in wing walls where unavoidable shall be horizontal and so located that no joint would be visible in the exposed face of the wing wall above the ground line.

3. Box Culverts

- Vertical construction joints shall be at right angles to the axis of the culvert.
- In general, the base slab or footings of box culverts shall be placed and allowed to set before the remainder of the culvert is constructed. In this case, suitable provision shall be made for bonding the sidewalk to the culvert bits; preferably by means of raised longitudinal keys so constructed as to prevent, as far as possible, the Percolation of water through the construction joint.
- In the construction of box culverts one and quarter meters or less in height, the sidewalls and top slab may be constructed as a monolithic unit. When this method of construction is used, necessary construction joints shall be vertical and at right angles to the axis of the culvert.
- In the construction of box culverts more than one and quarter Meters in height the concrete in the walls shall be placed and allowed to Set before the top slab is placed. In this case, appropriate keys shall be left in the sidewalls for anchoring the cover slab.
- If possible, each wing wall shall be constructed as a monolithic unit. Construction joints, where unavoidable, shall be horizontal and so located that no joint would be visible in the exposed face of the wing wall above the ground line.

4. Girders, Slabs and Columns

- For simple spans, concrete shall preferably be deposited by beginning at the center of the span and working from the center toward the ends. Concrete in girders shall be deposited uniformly for the full length of the girder and brought up evenly in horizontal layer. For continuous spans, where required by design considerations, the concrete placing sequence shall be shown on the plans or in the Special Provisions.
- Concrete in girder haunches less than one meter in height shall be placed at the same time as that in the girder stem, and the column or abutment tops shall be cut back to form seats for the haunches. Whenever any haunch or fillet has a vertical height of one meter or more, the abutment or columns, the haunch, and the girder shall be placed in three successive stages; first, to lower side of haunch, second, to the lower side of the girder, and the third to completion.
- For haunched continuous girders, the girder stem (including haunch) shall be placed to the top of stem. Where the size of the pour is such that it cannot be made in one continuous operation, vertical construction joints shall preferably be located within the area of contra flexure.
- Concrete in slab spans shall be placed in one continuous operation for each span unless otherwise provided. The, floors and girder of through girder super structures shall be placed in one continuous operation unless otherwise, specified, in which case a special shear anchorage shall be provided to ensure monolithic action between girder and floor.
- Concrete in T-beam or deck girder spans may be placed on one continuous operation or may be, placed in two separate operations; each of which shall be continuous; first, to the top of the girder stems and second, to completion. In the latter case, the bond between stem and slab shall be provided by suitable shear keys or by artificially roughening the surface of the top of the girder stem: In general, suitable keys may be formed by the use of timber blocks approximately. five by ten cm in cross-section and

having a length of ten cuts less than the width of the girder stem. These key blocks shall be spaced along the girder stems as required, but the spacing shall be not greater than thirty ems center to center. The blocks shall be removed as soon as the concrete has set sufficient to retain its shape.

- Concrete in box girders may be placed in two or three separate operations. In either case the bottom slab shall be placed first. Bond between the bottom slab and stem shall be positive and mechanical. If the webs are placed separately from the top slab, bond between the top slab and webs shall be secured in the same manner as for T-beams. Requirements for shear keys for T-beams shall also apply to box girders except that keys need not be deeper than the depth of the top of bottom slab reinforcement.
- Concrete in columns shall be placed in one continuous operation, unless otherwise directed. The concrete shall be allowed to set at least 24 hours before the caps are placed.
- When fiction collars are used to support nip forms, the concrete of columns shall have been ponded at least seven days earlier.
- Unless otherwise permitted, no concrete shall be placed in the super structures until the column forms have been stripped sufficiently to determine the character of the concrete in the columns. The load of the super structures shall not be allowed to come upon the bents until the test cylinders, representing the bents have obtained the minimum compressive strength but in no case in less than seven days.

5. Construction Joints

- Construction joints shall be made only where shown on the Drawings or called for in the pouring schedule. unless otherwise approved by the Engineer. If not detailed on the Drawings, construction joint, also in cases of emergency shall be placed to meet the approval of the Engineer. Shear keys or reinforcement shall be used unless otherwise specified, to transmit shear or bond the two sections together.
- Before depositing new concrete on or against concrete, which has hardened, the forms shall be re-tightened. The surface of the hardened concrete shall be roughened as required by the Engineer, in the manner that would not leave loose particles of aggregate or damaged concrete at the surface. It shall be thoroughly cleaned of foreign matter and laitance. When directed by the Engineer, the surface of the hardened concrete which would be in contact with new concrete shall be washed with water to ensure an excess of mortar at the juncture of the hardened and the newly deposited concrete, the cleaned and watered surfaces, including vertical and inclined surface, shall first be thoroughly covered with a coating of mortar of the same proportion of sand and cement as the class of concrete used against which the new concrete shall be placed before the grout of mortar has attained its final set.
- The placing of concrete shall be carried out continuously from joint to joint. The face edges of all joint, which are exposed, to view shall be carefully finished trim to line and elevation.

6. Provisional Openings for removal of Formwork

- The Contractor may require provisional openings for removal of formwork, in location and sizes. This requirement shall be subjected to the approval of the Engineer.
- The quantity of additional steel due to these openings will not be paid.
- Elsewhere, on visible faces, aesthetical treatment of construction joint will be provided by the Contractor without any extra payment.

7. Rubble or Cyclopean Concrete

- Rubble or cyclopean concrete shall consist of Class B concrete containing large embedded stone. The stone for this class of work shall be placed carefully so as to avoid damage to the forms or to the partially set adjacent concrete. Stratified stone shall be placed upon its natural bed. Stone shall be washed and saturated with water before placing.
- The total volume of the stone shall not be greater than one third of the total volume of the portion of the work in which it is placed. For walls of piers greater than sixty cm in thickness, stone of such size that one man can handle it; shall be used. Each stone shall be surrounded by at least fifteen cm of concrete and no stone shall be closer than thirty cm to any top surface nor any closer than fifteen cm to any coping. For walls or piers greater than one meter in thickness, larger stone 50kg or more may be used. Each stone shall be surrounded by at least thirty cm of concrete, and no stone shall be closer than sixty cm to any top surface nor closer than twenty cm to any coping.

8. Concrete Exposed to Sea Water

Unless otherwise specifically provided, concrete for structures exposed to sea water shall be Class A. The clear distance from the face of the concrete to the nearest face of reinforcement steel shall be not less than 10 cm. The concrete shall be mixed for a period of not less than 2 minutes and the water content of the mixture shall be carefully controlled and regulated so as to produce concrete of maximum impermeability. The concrete shall be thoroughly compacted and air pockets shall be avoided. No construction joints shall be formed between levels of extreme low water and extreme high water as determined by the Engineer. Between these levels' sea water shall not come in contact with the concrete for a period of not less than thirty days. The original surface, as the concrete comes from the forms shall be left undisturbed.

9. Concrete Exposed to Alkali Soils or Alkali Water

Where concrete may be exposed to the action of alkaline water or soils special care shall be taken to place it in accordance with Specifications herein. Wherever possible, placing shall be continuous until completion of the section or until the concrete is at least fifty cm, above ground or water level. Alkaline water or soils shall not be in contact with the concrete during placement and for a period of at least seventy-two hours thereafter.

10. Protection of Concrete from Environmental Conditions

Precautions shall be taken as needed to protect concrete from damage due to weather or other environmental condition during placing and curing operations. Any concrete placed during hot weather or during cold weather shall be at the Contractor's risk and any damaged concrete shall be removed and replaced at the Contractor's expense.

a. Rain Protection

Under conditions of rain, the placing of concrete shall not commence or shall be stopped unless adequate protection is provided to prevent damage to the surface mortar or damaging flow or wash of the concrete surface.

b. Work in Hot Weather

- The temperature of concrete shall not exceed thirty-two degrees centigrade at the time of laying, unless the Contractor incorporates in the mix a plasticizer, of a make and in proportion which he has shown by laboratory test and full-scale trial to be satisfactory, to eliminate detrimental effects of high temperature. Without introducing any other detrimental effect on quality.
- The following may be used to keep the temperature of concrete below the above limitations: -
- Chilling of concrete water by heat exchange coils or by addition of broken ice, provided that the water shall be free from ice, at the time of entry into the mixer.
- Cooling of coarse aggregate by watering provided that the water content of the aggregate so cooled shall be uniform.
- Reclaiming of aggregate from stock piles by the tunnel method to avoid using the surface layer of the stockpile with shade and wind protection of conveyor elevating to hatching.
- Night work provided that (i), (ii) and (iii) are proved inadequate or unsatisfactory in their results and providing also that the Engineer has no other reason for refusing permission for night work.
- The Engineer shall have power to order the suspension of concrete production in case of not taking precautionary measures by the Contractor as mentioned above. Under no circumstances would the Contractor be entitled to receive any additional payment for complying with the requirements of this clause

c. Work in Cold Weather

Except by written approval of the Engineer, concreting operations shall not be continued when a descending air temperature in the shade and away from artificial heat falls below five degrees centigrade, nor resumed until an ascending air temperature in the, shade and away from artificial heat reaches two degree centigrade. In such cases, the mixing water and/or aggregates, shall be heated to not less than twenty-one degrees centigrade nor more than sixty-six degrees centigrade, prior to being placed in the mixer by an approved type of heating device so that the temperature of the concrete shall not be less than ten degrees centigrade, nor more than twenty-seven degrees centigrade, at the lime of placing. No materials containing frost shall be used. Cement or fine aggregates containing lumps or crusts of hardened materials shall not be used.

16.5.1.3.7 Concrete Surface Rendering / Finishing**1. General**

Concrete surface finishes shall be classified as follows: -

- Bridge Deck Surface Finish
- Sidewalk Surface Finish
- Ordinary Surface Form Finish
- Class 1 - Surface Form Finish

The bridge deck surface finish shall be given to the surface of the bottom slabs of all box type underpass structures. The requirements for sidewalk surface finish apply to the surface of the bottom slabs is box culverts, except that the acceptable variation from a three-meter straight

edge shall be 10mm, and booming shall be omitted. The ordinary surface form finish shall be the final finish applied to all surfaces after removal of forms, unless otherwise specified or called for on the drawings. The Class 1 surface form finish shall be applied only where specified; or as required by the Engineer when the ordinary surface finish does not produce the required smooth; even surface of uniform texture and appearances.

2. Bridge Deck Finish

- A smooth riding surface of uniform texture, true to the required-grade and cross-section, shall be obtained on all bridge roadway decks. The Contractor may use hand tools, or finishing machines or a combination of both, conforming to the requirements specified herein for finishing bridge roadway deck concrete.
- Finishing of concrete placed in bridge shall consist essentially of compacting and striking off the surface of the concrete as placed and floating with longitudinal floats the surface so struck off.
- The placing of concrete in bridge roadway decks would not be permitted until the Engineer is satisfied that the rate of producing concrete would be sufficient to complete the proposed placing and finishing operation within the schedule time, that experienced finishing machine operators and concrete finishers are employed to finish the deck, that fogging equipment and all necessary finishing tools and equipment are on hand at the site of the work and in satisfactory condition for use. Finishing marlines shall be set up sufficiently in advance of use to permit inspection by the Engineer during the daylight hours before each pour.
- The adjustment and operation of deck finishing machines shall be verified by moving the Machine over the full length of the deck section to be placed and traversing the floats completely across all end bulkheads before placement of concrete is begun.
- Unless adequate lighting facilities are provided by the Contractor, the placing of concrete, in bridge decks shall cease at such time that finishing operation can be completed during daylight hours.
- Rails for the support and operation of, finishing machines and headers for hand-operated stack-off devices shall be completely in place and firmly Secured. for the scheduled length for concrete placement before: placing of concrete. Rails for finishing machines shall extend beyond both ends of the scheduled length for concrete placement to a sufficient distance that would permit the float of the finishing machine to fully clear the concrete to be placed. Rails or headers shall be adjustable for elevation and shall be set to elevations with allowance for anticipated settlement; camber; and deflection of false work, as required to obtain a bridge roadway deck true to the required grade and cross-section. Rails or headers shall be of a type and shall be so installed that no springing or deflection would occur under the weight of the finishing equipment and shall be so located that finishing equipment may, operate without interruption over the entire bridge roadway deck to be finished.
- Rails or headers shall be adjusted as necessary to correct for unanticipated settlement or deflection, which may occur during finishing operations.
- Should settlement or other unanticipated events occur, which in the opinion of the Engineer would prevent pouring of bridge deck conforming to the requirements of these Specifications, placing of deck concrete shall be discontinued until corrective measures satisfactory to the Engineer are provided. In the event satisfactory measures are not provided prior to initial set of the concrete in the effected area the placing of concrete shall be discontinued and a bulkhead installed at a location determined by the Engineer. All concrete in place beyond the bulkhead shall be removed.

- Unless otherwise permitted by the Engineer, bridge deck concrete shall be placed in a uniform heading approximately parallel to the bridge pier on bent caps. The rate of placing concrete shall be limited to that which can be finished before the beginning of initial set except that concrete for the deck surface shall not be placed more than three meters ahead of strike off.
- After the concrete has been placed, compacted, and consolidated, the surface of the concrete shall be carefully struck off by means of a hand-operated strike board operating on headers, or by a finishing machine operating on rails. A uniform deck surface true to the required grade and cross-section shall be obtained.
- Following strike off, the surface of the concrete shall be floated longitudinally. In the event strike-off is performed by means of a hand-operated strike board, two separate hand-operated float boards for longitudinal floating shall be provided. The first float shall be placed in operation as soon as the condition of the concrete would permit and the second float shall be operated as far back of the first float as the workability of the concrete would permit.
- In the event the strike, off is performed with a finishing machine; longitudinal floating of the concrete shall be performed by means of a hand-operated float board or a finishing machine equipped with a longitudinal wooden float. The longitudinal wooden float on the finishing machine shall have a length of not less than two and half meters nor more than three and half meters. When both ' strike off and longitudinal floating are to be performed by finishing machines; One machine, with operator, shall be used for strike off and a second machine, with a second operator, shall be used for longitudinal floating. Longitudinal floating may be permitted with the same finishing machine that is used for strike off provided that the length of deck unit being placed is not more than 10 meters and the strike off operation is completed for said deck unit before the condition of the concrete requires that longitudinal floating be started.
- Finishing machines used for strike off having a wheel base 1.8 meters or less shall be followed by 2 separate hand-operated float boards for longitudinal, floating. All the provisions in this item pertaining to hand-operated float boards shall apply to the 2 separate float boards for longitudinal floating.
- Longitudinal floats, either hand-operated or machine-operated, shall be used with long axis of the float parallel to the center line of the bridge roadway. The float shall be operated with a combined longitudinal and transverse motion planning off the high areas and floating the material removed into the low areas. Each pass of the float shall lap the previous pass by one-half the length of the float. Floating shall be continued until a smooth riding surface is obtained.
- In advance of curing operations, the surface of the concrete shall be textured by browning with a stiff bristled broom or by other suitable devices. Which would result in uniform scouring. The operation shall be performed at a time and, in a manner, to produce a hardened surface having a uniform texture.
- Hand-operated float boards shall be from three and half to five meters long, ribbed and trussed as necessary to provide a rigid float and shall be equipped with an adjustable handle at each end. The float shall be wood, not less than two and half inches thick and from ten cm to twenty cm wide. Adjusting screws spaced as not to exceed 60 cm on centers shall be provided between the float and the rib. The float board shall, be maintained free of twist and true at all times.
- Hand-operated float boards shall be operated from transverse finishing bridges. The finishing bridges shall span completely the roadway area being floated & sufficient number of finishing bridges shall be provided to permit operation, of the floats without undue delay. Not less than two transverse finishing bridges shall be provided when hand operated float boards are used. When a finishing machine is used for longitudinal

floating; one finishing bridge equivalent to the transverse finishing bridge specified herein shall be furnished for use by the Engineer.

- All finishing bridges shall be of rigid construction and shall be free of excessive wobble and springing when used by the operators of longitudinal floats and shall be easily moved.
- Immediately following completion of the deck finishing operation, the concrete in the deck shall be cured as specified in item "Gluing Concrete" hereinafter.
- The finished surface of the concrete shall be tested by means of a straightedge three meters long. The surface shall not vary more than three mm from the lower edge of the straightedge. All high areas in the hardened surface in excess of three mm as indicated by testing shall be removed by abrasive means. After grinding by abrasive means has been performed, the surface of the concrete shall not be smooth or polished. Ground areas shall not be of uniform texture and shall present neat and approximately rectangular patterns.
- Where the concrete of the bridge deck is to be covered by bituminous surfacing, earth, or other cover, two and half cm or more in thickness, the surface of the concrete shall not vary more than nine mm from the lower edge of the three meter straightedge.
- Bridge deck surfaces under the curbs, railings and sidewalk shall be struck off to the same plane as the roadway and left undisturbed when future widening is shown on the plans.

3. Side walk Surface Finish

After the concrete has been placed it shall be compacted and the concrete shall be struck off by means of a strike board, floated with a woken or cork floating and finished with a broom. An approved edging tool shall be used on all edges and at all expansion joints. Browning shall be transverse to the line of traffic and if water is necessary, it shall be applied to the surface immediately in advance of brooming. The surface shall not vary more than six mm under a three-meter straightedge, and the finished surface shall be free of blemishes.

4. Ordinary Surface form Finish

- Ordinary surface finish shall consist of filling holes or depressions in the surface of the concrete, repairing all rock pockets, removing stains and discoloration visible from traveled ways. Ordinary surface finish shall be applied to all concrete surfaces either as a final finish or preparatory to the Class 1 finish. On surfaces, which are to be buried underground or surface, which are enclosed, such as the cells of box girders; the removal of fins would not be required.
- Except as provided herein, all form bolts and any metal placed for the convenience of the Contractor shall be removed to a depth of at least two and half cms below the surface of the concrete. The resulting holes or depression shall be cleaned and filled with mortar. Form bolts projecting into cells of box girders need not be removed unless permanent access is provided into the cells in which case such bolts shall be removed flush with the surface of the concrete. Mortar used to fill bolt holes shall consist of one-part cement and two parts sand. Other depressions and pockets shall be filled with either packed, mortar air blown mortar as directed by the Engineer. Mortar shall be cured in conformance with the requirements in item "Curing Structures".
- If rock pockets or holes in the opinion of the Engineer, are of such an extent or character as to affect the strength of the structures materially or to endanger the life of the steel reinforcement, he may declare the concrete defective and require the removal and replacement of the portions of the structures affected.

5. Class 1 Surface Form Finish

- Class I surface finish shall consist of finishing the surfaces of the structure as necessary to produce even surfaces of uniform texture and appearance, free of unsightly bulges, depressions and other imperfections. The degree of care in building forms and character of materials used in from work would be a contributing factor in the amount of additional finishing required to produce mien surfaces of uniform texture and appearance, free of unsightly bulges, depressions and other imperfections; and the Engineer shall be the sole judge in this respect.
- After completion of the ordinary surface finish, areas which do not exhibit the required smooth, even surface of uniform' texture and appearance shall be sanded with power sanders or other approved abrasive means until smooth, even surfaces of uniform texture and appearance are obtained. The use of power carborundum stones or disks would be required to remove bulges and other imperfections.
- Class 1 surface finish shall not be applied until a uniform appearance can be obtained.

Class 1 surface finish maybe required to be applied as the final finish for the following surfaces.

- All form finish surfaces of bridge super-structures except the under surfaces between girders and the inside vertical surfaces of T girders.
- All surfaces of bridge piers, column and abutments, and retaining walls above finished ground and to at least three tenth meter below finished ground.
- All surface of open spandrel arch rings. spandrel columns and abutment walls.
- All surfaces of pedestrian under crossings, except floors and surfaces to be covered with earth.
- Surface above finished ground of culvert headwalls, end walls and retaining walls.
- Surface inside of culvert barrels having, a height. of one and. half meters or more for a distance inside the barrel at least equal to the height of the culvert.
- All surfaces of railings.

6. Surface Rendering

All faces of concrete which are to come in contact with back fill or pavement materials shall be applied two coats of hot bitumen of approved quality, before placing any material around concrete.

16.5.1.3.8 Curing of Concrete

1. General

All newly placed concrete shall be cured in accordance with these Specifications.

2. Method of Curing

The curing method shall be one or more of the following as described hereinafter.

- Water Method
- Curing compound Method
- Reinforced Waterproof Paper Method if required by the Engineer.
- Forms-in-Place Method

- Steam Method
- Polyethylene Sheeting Method.

a. Water Method

- The concrete shall be kept continuously wet by the application of water for a minimum period of seven days after the concrete has been placed.
- Cotton mats, burlaps, rugs, carpets or burlap or land blankets, may use as a curing medium to retain the moisture, the entire surface of the concrete shall be kept damp by applying water with a nozzle that so atomizes the flow (but a mist and not a spray is formed, until the surface of the concrete is covered with the curing medium. The moisture from the nozzle shall not be applied under pressure directly upon the concrete in a quantity sufficient to cause a flow or wash the surface. At the expiration of the curing period the concrete surface shall be free of all curing mediums.
- When concrete bridge decks and flat slabs are to be cured without the use of a moisture retaining medium, the entire surface of the bridge deck or slab shall be kept damp by the application of water with an atomizing nozzle as specified in the preceding paragraph until the concrete has set, after which the entire surface of the concrete shall be sprinkled continuously with water for a period of not less than seven days.

b. Curing Compound Method

- Surfaces exposed to the air may be cured by the application of an impervious membrane.
- The membrane-forming compound used shall consist of a practically colorless liquid. The use of any membrane forming compound that would alter the natural colour of the concrete or impart a slippery surface to any wearing surface shall be prohibited. The compound shall be applied with a pressure spray in such a manner as to cover the entire concrete surface with a uniform film, and shall be of such character that it would harden within 30 minutes after application. The amount of compound applied shall be ample to seal the surface of the concrete thoroughly. Power operated spraying equipment shall be equipped with an operational pressure gauge and means of controlling the pressure.
- The curing compound shall be applied to the concrete following the surface finishing operation immediately after the moisture sheen begins to disappear from the surface, but before any drying shrinkage or craze cracks begin to appear. In the event of any delay in the application of curing compound; which results in any drying or cracking of the surface, application of water with an atomizing nozzle as specified under "Water Method", shall be stopped immediately and shall be continued until application of the compound which shall not be applied over any free-standing water surface. If the film of compound be damaged from any cause before the expiration of seven days after the concrete is placed in the case of Structures, the damaged portion shall be repaired immediately with additional compound.
- Curing compound shall not harden in storage. They shall not be diluted or altered in any manner after manufacture. At this time of use, the compound shall be in a thoroughly mixed condition. If the compound had not been used within 120 days after the date of manufacture, the Engineer may require additional testing before use to determine compliance to requirements.
- An anti-settling agent or combination of anti-settling agents shall be incorporated in the curing compound to prevent caking.

- The curing compound shall be packaged in clean barrels or Steel containers or shall be supplied from a suitable storage tank located at the job-site. On site storage tanks shall have a permanent system designed to, completely re-disperse any settled material without introducing air or any other foreign substance. Containers shall be well sealed with ring seals and lug type crimp lids. The' linings of the containers Shall. be of a character that would resist the solvent of the curing compound, Each Container shall be labeled with the manufacturer's name. Specifications number, batch number, number of gallons and date of manufacture, and shall have a label waiting concerning flammability. The label shall I also warn that the curing compound shall be well stirred before use. When the curing compound is shipped in tanks or tank trucks, a shipping invoice shall accompany each. load. The invoice shall contain the same information as that. required hatch) for container labels.
- Curing compound may be sampled by the Engineer at the source of supply and at the job site.

c. Reinforced Waterproof Paper Method

- The exposed finished surfaces of concrete shall be sprayed with water, using a nozzle that so, atomizes the flow that a mist and not a spray is formed, until the concrete has set, after which the waterproof paper shall be placed. The papers hall remains in place for a period of not less than 72 hours.
- Reinforced waterproof paper shall comply with ASTM C 171 Specifications. It shall be composed of two sheets of Kraft paper cemented together. with -u bituminous adhesive and reinforced with fiber. The waterproof paper shall be formed into sheets of such width as to provide a compete 'cover of entire concrete surface.
- All joints in the sheets shall be securely, cemented together in such a Manner as to provide a waterproof of joint. The joint seams shall have minimum lap of ten cm.
- The sheets shall be securely weighted down by placing a bank of earth on the edges of the sheets or by other means satisfactory to the Engineer.
- Shall any portion of the sheets be, broken or damaged within seventy-two hours after being placid, the broken or damaged portions shall be immediately repaired with new sheets properly cemented into place.
- Sections of sheets, which have lost their waterproof qualities or have been damaged to such an extent as to render them unfit for curing the concrete shall not be used.

d. Forms-in-Place Method

Formed surfaces of concrete may be cured by 'retaining the forms-in-Place. The forms shall remains in place for a minimum period of seven days after the. concrete has been placed, except. that for members over five ems in least dimension, the forms shall be in place for a minimum period of five days. Wooden forms shall be kept wet by watering during. the curing.

e. Steam Method

After placing and vibrating, the concrete shall be allowed to attain its initial set before steam is applied. During the plating of concrete and application of steam, provision shall be made to prevent surface drying by means of a coating of approved material. The optimum curing temperature shall not exceed sixty-five degrees centigrade.

f. Polyethylene Sheeting Method

The wet surface of fresh concrete shall be covered with white polyethylene sheeting soon as possible without marring the surface and shall cover all exposed surfaces of the concrete. The edges of the sheeting shall be weighted securely with a continuous windrow of earth or any other means satisfactory to the Engineer to provide an air-tight cover. Adjoining sheets shall overlap not less than thirty cm. and the laps shall be securely weighted with earth, or any Other means satisfactory to the Engineer to provide an air-tight cover.

3. Curing Structures

- All newly placed concrete for cast-in-place structures, other than highway bridge decks, shall be cured by the water methods, the forms-in-place Method, or, as permitted herein, by the curing compound method, all in accordance with the requirements in "Methods of Curing".
- The curing compound method may be used on concrete surfaces which are to be buried underground, and surfaces where only Ordinary Surface Finish is to be applied and on which a uniform colour is not required and which would not be visible from any public traveled way.
- The top surface of highway bridge decks shall be cured by both the curing compound method, and by the water method. The curing compound shall be applied progressively during the deck finishing operation immediately after finishing operations are completed on each individual portion of the deck. The water cure shall be applied not later than four hours after completion of the deck finishing' or for portions of the decks on which finishing is completed after normal working hours, the water cure be applied not later than 8.00 am. the following morning.
- When deemed necessary by the Engineer during Periods of Intl ma. alter. water shall be applied to concrete sulfa= being cured by the curing compound method or by the forms in-place method, until the Engineer, determines that a cooling effect is no longer required.

4. Curing Precast Concrete Members

- Precast concrete members shall be Cured for riot less than seven days by the water method or by steam curing for a period in which eighty percent of strength achieved, at the option of the Contractor. Steam curing for precast members shall conform to the following provisions.
- After placement of the concrete members shall be held for minimum four hours pre-casting period.
- To prevent moisture loss on exposed surfaces during the pre-steaming period, members shall be covered immediately after casting or the exposed surfaces shall be kept wet by fog spray or wet blankets.
- Enclosures for steam curing shall allow free circulation of steam about the member and shall be constructed to contain the live steam with a minimum moisture loss. The use of the tarpaulins or similar flexible 'covers would. be permitted, provided they are kept in good repair and secured in such a Manner to prevent the loss of steam and moisture.
- Steam at jets shall be low pressure and in a saturated condition. Steam at jets. shall not impinge directly on the concrete; test cylinders or forms. During application of the steam, the temperature rise within the enclosure shall not exceed twenty degree centigrade per hour. The curing temperature throughout the enclosure shall not exceed sixty-five degree. centigrade and be maintained at a constant level for a sufficient time

necessary to develop' the required compressive strength. Control cylinders shall be covered to prevent moisture loss and be placed in a location where temperature is representative of the average temperature of the enclosure.

- Temperature recording devices providing an accurate continuous permanent record of the curing temperature shall be provided. A minimum of one -temperature recording device per sixty meters of continuous bed length would be required for checking temperature.
- Curing of precast concrete would be considered completed after a termination of the steam curing cycle.

5. Curing Precast Concrete Piles

All newly placed concrete precast piles, both conventionally reinforced and pre-stressed shall be "cured by the "Water Method" except "Curing Precast Concrete Members" that the concrete shall be kept under moisture for at least fourteen (14) days. It is optional that steam curing shall apply except that the concrete shall be kept wet for at least seven days including the holding and steaming period.

16.5.1.3.9 Testing and Sampling

1. Testing of Aggregate

Samples of fine and coarse aggregate to be used shall be selected by the Engineer. It shall be the responsibility of the Contractor to designate the source or sources of aggregate and to obtain the necessary samples and submit them for testing of least thirty days before actual concreting operations are to begin. Samples of aggregates shall be obtained and tested in accordance with the following standard.

AASHTO methods: -

- | | |
|----------------------------------------------------------------------------------------|------------|
| ➤ Sampling aggregates. | T-2 |
| ➤ Sieve analysis | T-27 |
| ➤ Amount of material passing the No. 200 size | T-11 |
| ➤ Organic impurities | T-21 |
| ➤ Mortar Strength | T-71 |
| ➤ Sodium sulphate soundness | T-104 |
| ➤ Friable particles | T-112 |
| ➤ Abrasion loss | T-96 |
| ➤ Specific Gravity | T-84 |
| ➤ Absorption | T-115 |
| ➤ Production of Plastic Fines | T-210 |
| ➤ Fineness Modulus | T-27 |
| ➤ Sand Equivalent | T-17 |
| ➤ Potential Reactivity of Carbonate Rocks for Concrete Aggregate Rock Cylinder Method) | ASTM C 586 |
| ➤ Potential Alkali Reactivity of Cement Aggregate Combinations (Mona-Bar Method). | ASTMC 227 |
| ➤ Potential Reactivity of Aggregates | ASTM C 289 |

(Chemical Methods)

No aggregate for testing during the production of concrete shall be sampled at the discharge gates of the bins feeding the weight hopper. The Contractor, at his expense, shall Provide safe and suitable facilities for obtaining the samples. No concreting work on the project would be permitted until the Engineer signifies in writing his approval, following the performance of the necessary tests, on all the materials involved in making concrete.

2. Testing of Compressive Strength

- Concrete compressive strength requirements consist of a minimum strength at the age of twenty-eight days and the minimum strength which must be attained before various loads or stresses are applied to the concrete. The various strengths. required are specified in earlier Table.
- The compressive strength of concrete would be determined from test cylinders, which have been fabricated from concrete sampled and tested in accordance with AASHTO T-23 and AASHTO T-22.
- A set of six cylinders shall be taken from each fifty cubic meters of each class of concrete or fraction thereof placed each day, three of the six cylinders to be tested after seven days and three after twenty-eight days.
- The minimum average 28 days' test result of all samples tested at any time shall be the specified twenty-eight days' strength.
- No individual samples tested after 28 days shall show at test result lower than eighty-five percent of the required twenty-eight days.
- Concrete represented by any single: test cylinders that fails to comply with the requirement under (b) above would be rejected unless the Contractor at his expense, provides that the strength and quality of the Concrete placed in the work are acceptable. If such evidence consists of tests made on cores taken from the work, the cores shall be obtained and tested in accordance with the Specifications of AASHTO T-24. Test results of the cores shall meet the following requirements: -
- Average test results of the cores shall be less than the minimum required twenty-eight days' strength.
- No individual core shall show a strength less than ninety-five percent of the required twenty-eight days' strength.
- Shall the above test results fail to comply with the requirements, concrete of that particular pour shall be rejected and removed as directed by the Engineer. Furthermore, Contractor shall redesign the concrete mix for approval of the Engineer.
- In cast, seven days' strength show less than seventy percent of the twenty-eight days' strength (in case of Type-I cement), Engineer may stop further work on that particular portion of concrete, unless twenty-eight days' strength gives satisfactory results.

3. Trial Batches for Mix Productions

- The placing of-concrete shall not begin until trial batches of the mix design to be used have been produced by the Contractor and tested and approved by the Engineer. The trial mix proportions shall be such that the average strength of five consecutive test cylinders shall be 20, percent higher than the specified twenty-eight days Strength and no individual test cylinder shall be below the specified strength.
- When concrete compressive strength is specified as a prerequisite to applying loads or stresses to a concrete structures or member, test cylinders would be cured under

conditions similar to those at the casting site. The compressive strength of concrete determined for such purposes would be evaluated on the basis of individual tests.

16.5.1.4 Measurement and Payments

16.5.1.4.1 Measurements

- The quantity of concrete to be paid for shall be the number of cubic meters of concrete of the various classes complete in place and accepted.
- In measuring the volume of concrete to be paid for, the dimension to be applied shall be those shown on the Drawings except where others ordered by the Engineer in writing,
- Deductions from the theoretical volume of concrete shall be made for the volumes of draining holes, weep holes, pipes and Conduits, etc., in case where their cross-sectional areas exceed 500 square cm.
- The Measurement shall not include any concrete used in the construction of cofferdams
- The volume involved in fillets, scorings or chamfers ten square cms in cross-sectional area or less shall be disregarded when measuring the quantity of concrete to be paid for.
- Concrete for railings, pipe culverts, etc.; is not to be measured under this item, but under separate items.

16.5.1.4.2 Payments

For all concrete structures or portions, thereof, no separate measurement or payment shall be made for false work, centering, formwork or any other temporary work to complete the concrete structure or portion thereof, payment for all such temporary works shall be deemed to be included in the Contract price paid under various items of concrete work. The accepted quantity measured as provided above shall be paid for at the Contract unit price respectively for the pay items listed below and shown in the Bill of Quantities, which price and payment shall be full compensation for such works as curing, surface finishing and/or rendering as required, formation of construction joints and any such work and incidentals necessary to complete the work prescribed in this Section except works that are paid for under other pay items: -

Pay item No.	Description	Unit
16.5.1.4.2.1	Concrete Class A1 i) Under Ground ii) On Ground iii) Elevated	Cub. Ft or CM Cub. Ft or CM Cub. Ft or CM
16.5.1.4.2.2	Concrete Class A2 i) Under Water ii) Under Ground iii) On Ground iv) Elevated	Cub. Ft or CM Cub. Ft or CM Cub. Ft or CM Cub. Ft or CM
16.5.1.4.2.3	Concrete Class A3 i) Under Ground ii) On Ground iii) Elevated iv) Concrete for Pile Works	Cub. Ft or CM Cub. Ft or CM Cub. Ft or CM Cub. Ft or CM
16.5.1.4.2.4	Concrete Class B – to be used where specified	Cub. Ft or CM

16.5.1.4.2.5	Concrete Class C to be used for Cribbing or as specified i) Under Ground ii) On Ground iii) Elevated	Cub. Ft or CM Cub. Ft or CM Cub. Ft or CM Cub. Ft or CM
16.5.1.4.2.6	Concrete Class D1 to be used for pre-stressed or post-tensioning	Cub. Ft or CM
16.5.1.4.2.7	Concrete Class D2	Cub. Ft or CM
16.5.1.4.2.8	Concrete Class D3	Cub. Ft or CM
16.5.1.4.2.9	Concrete Class Y to be used as filler in concrete girders	Cub. Ft or CM
16.5.1.4.2.10	Lean Concrete	Cub. Ft or CM
16.5.1.4.2.11	Precast Concrete, Class i) Precast Concrete Class A1 ii) Precast Concrete Class A2 iii) Precast Concrete Class A3 iv) Precast Concrete Class C	Cub. Ft or CM Cub. Ft or CM Cub. Ft or CM Cub. Ft or CM Cub. Ft or CM

16.5.2 Concrete Pavements

16.5.2.1 Description

This work shall consist of a pavement composed of Portland cement concrete with or without reinforcement as specified constructed on a prepared subgrade or base course in accordance with these Specifications and in conformity with the lines, grades, thickness and typical cross-sections shown on the plans. Both plain and reinforced concrete shall include deformed bars for contraction joints and dowel bars for expansion joints or as shown on the drawings.

16.5.2.2 Material Requirements

16.5.2.2.1 Concrete

Concrete material shall conform to the requirements indicated in Chapter 6 of this volume and as specified hereinafter. In addition to it, the Contractor shall advise the Engineer immediately after the award of the contract of the source of all materials to be used in proportioning concrete for the work. If the Contractor later proposes to obtain materials from a different source, he shall notify the Engineer at least 30-days before such materials are to be used.

16.5.2.2.2 Reinforcing Steel

Concrete reinforcement shall conform to Chapter 6 of this volume or hereafter specified in this chapter. If required, steel fabric for reinforcement of concrete shall conform to AASHTO M 55-73 and supplied in sheets.

16.5.2.2.3 Polythene Sheeting

Polythene sheeting for placing immediately below concrete slabs shall be 0.065mm thick or having a minimum weight of 50g/m² (whichever is greater) made from polythene or other approved hydrocarbon thermoplastic resin (produced by the polymerization of ethylene under high pressure and density) and given an anti-static treatment to 'reduce dust attraction and reduce friction. The sheeting shall have the minimum mechanical properties shown in table as under: -

Properties	Machine Direction	Transverse Direction
Tensile Strength Method ASTM D882-73 kgf/SM	140	105
Elongation at breaks %	150	500
Tear Strength Elmendorf Method ASTM D689- 62(1974)- Kg/cm ³	390	310

Table 60, Properties of Polythene Sheeting

16.5.2.2.4 Joint Filler

Joint filler shall consist of cane or other suitable long fibers of a cellular nature uniformly impregnated with asphalt. The asphalt content of the joint material shall be between 30 – 50%. The joint material would not deteriorate under any weather conditions and is to be of such a character as not to be permanently deformed or broken by moderate twisting, bending or other ordinary handling. Strips of the joint filler which do not conform to the specified dimensions within the tolerance + 2mm for thickness and + 12mm for depth are to be rejected. All damaged strips are to be rejected too.

16.5.2.2.5 Joint Sealing Compound

Joint sealing compound has to be as BS 2499(1973) type A1 or A2, or as approved by the Engineer. The compound is to be impermeable is to withstand all weather conditions and is to be capable of adhering to the concrete without cracking, spalling or disintegrating and would not require impracticable condition of dryness or cleanliness of the concrete slabs. Where recommended by the manufacturer of the sealing compound, a primer supplied by him is to be used to improve adhesion.

16.5.2.2.6 Dowel Bars

Dowel bars shall be cut from mild steel bars and would be approved by the, Engineer. The Contractor's attention is directed to the requirement that one end of each dowel bar in all joints, except bonded construction joints, shall be sawn and not sheared so that no irregularities likely to interfere with its sliding action in the concrete shall occur. The minimum length of the dowel bars spaced at 1m center to center or as shown on the drawings, shall be 35-times the diameter of the bar used unless otherwise specified or as directed by the Engineer.

16.5.2.2.7 Expansion Caps

Expansion Caps for dowel bars in expansion joints shall consist of pressed metal sleeves plugged at one end by punching the specified joint filler board of a wad of cotton waste of similar compressibility and sealed at the end against entry of mortar. The tube shall have an internal diameter permitting sliding on the dowel bar but close enough to prevent entry of mortar.

16.5.2.2.8 Darkening Agent

Darkening agent for the top course of concrete payments if ordered and specified shall be a carbon black; either as an aqueous dispersion containing at least 25% of solids, to be added to the mixing water, or is a self-dispersing powder to be added to aggregate and cement. It shall be approved by the Engineer as non-deleterious and as giving a grey colour and shall

be added at the rate of 0.1% by weight of the mixed concrete if it is aqueous dispersion, the minimum quantity of self-dispersing powder shall be 0.025% by weight of the concrete aggregate. The darkening agent shall be free from Sulphur trioxide and form any other matter deleterious to concrete.

16.5.2.2.9 Crack Inducing Battens

Crack inducing battens shall be of wood or of any other suitable material proposed by Contractor at the time of tendering and approved of at the award of the Contractor approved by the Engineer at his discretion after the award of the Contract. Battens of highly absorbent wood or other material shall be of cross-sectional dimensions shown on the drawings, and treated to prevent adhesion between them and the concrete.

16.5.2.2.10 Testing and Sampling

All materials shall be approved by the Engineer prior to use in the work. Additional samples would be taken and tested by the Employer during the progress of the work to check on the quality of the materials being supplied and/or placed by the Contractor. The results of these tests would be available for the Contractor's use; however, they are not intended for construction control purpose. The Contractor shall set up his own test facilities or arrange the same from a private laboratory, to assure that his materials and workmanship comply with the Specifications.

16.5.2.2.11 Plant and Equipment

Plant and equipment needed for making the required concrete shall be in accordance with 16.4.16 'Proof rolling'.

16.5.2.3 Construction Requirements

16.5.2.3.1 Pavement Base Course

- The base upon which the concrete pavement is laid shall be leveled compacted and true to the grades and cross-sections shown on the plans and shall be so maintained; as provided under such other items throughout the period of placing concrete pavement.
- To ensure the proper depth and section, a scratch template true to depth and section and resting on accurately set side forms shall be moved over the surface immediately before placing concrete and any irregularities shall be immediately corrected. High spots shall be planed down and the Contractor shall have the option of either filling low spots to the proper elevation with approved material, which shall be watered compacted and struck off to the required grade or of placing additional concrete. No Measurement or payment would be made for such additional concrete.
- Until the subgrade has been checked and approved, no material shall be deposited thereon. Storing or stock piling of materials on the subgrade and placing of surfacing material or laying of pavement on muddy or frozen subgrade would not be permitted.

16.5.2.3.2 Forms

- Side forms shall be made of metal of an approved section and construction provided with adequate devices for secure setting so that when in place, they shall withstand

the impact and vibration of the compacting and finishing equipment with settlement not exceeding 1.5mm in 3m from a true plane surface on the top of the form and inside face shall not vary more than 6mm from a plane surface. The width of the bases of steel forms shall be not less than their height except that the forms having a base not less than $\frac{2}{3}$ rd of their height and meeting all other requirements herein may be used for manual laying of non-rectangular bays.

- The depth shall be equal to the thickness of the pavement at the edge or as shown on the plans. The forms sections shall be tightly joined by each joint free from play in any direction. These forms shall be stacked with steel stakes and shall be of a length approved by the Engineer. Each section of forms shall have stake pocket at each end and at intervals of not more than 1 & 1.5m between ends.
- Each section of forms shall be straight and free from bends and warps at all times.
- Side forms for machine placing shall have rolled section steel rails which shall be of Construction Requirements adequate stiffness to carry the laying, compaction and finishing machines.
- These machines shall not run on folded sheet metal form tops. The top faces of the forms are to be carefully cleaned and maintained. The tops shall be without horizontal joint and with flange braces extending outward on the base not less than $\frac{2}{3}$ rd the height of the forms. Each stake pocket shall be, equipped with a positive non-detachable wedge. These forms shall be placed by using at least 3-steel pins of the size and length approved by the Engineer or as shown on the plans. They shall be equipped with positive locking devices which would permit neat tight joints and do not deform under impact vibration by thrust. Pins for stacking forms in place shall be made of Steel at least 2cm in diameter as directed by the Engineer in case of impractical use.
- Wooden forms may be used for curves having a radius of less than 50m. They shall be made of 2.5cm well-seasoned surfaced plank fastened together and shall be attached securely to a wooden base in width. All wooden forms shall be braced at least every 60cm with steel pins of the size and length herein specified. Straight forms shall be set out as chords to convex edges and as tangents to concave edges, but payment would not be made of concrete outside the curved edges shown on the Drawings.
- Before placing forms, the underlying material shall be excavated to the required grade, and shall be firm and compact. The forms shall have full bearings upon the foundation throughout their length and shall place with exactness to the required grade and alignment of the edge of the finished pavement.
- Forms shall be set to the required lines and grades well in advance of placing concrete, preferable not less than 200m. Forms shall not be removed for at least 12 hours after the concrete has been placed. Forms shall be carefully removed in a manner to avoid damage to the pavement. Under no circumstances would the use of pry bars between the forms and the pavement be permitted. Pavement which in the opinion of the Engineer is damaged due to the careless removal of forms shall be repaved by the Contractor as directed by Engineer at the Contractor's own expense.
- Forms shall be thoroughly cleaned and oiled each time they are used.
- Special forms or other supporting devices meeting the approval of the Engineer shall be used to support the joint filler at transverse control joints, when concrete is to be placed on only one side of the tiller. When pavement is placed adjoining existing concrete pavement upon which the finishing machine would travel, any irregularities in the old pavement shall be ground down to a true uniform surface of sufficient width to accommodate the wheels of the finishing equipment if necessary, to obtain proper smoothness of the pavement.

16.5.2.3.3 Composition and Compressive Strength of Concrete

- All concrete shall be proportioned by weighing and shall conform. to the following strength and mix requirements.

• Compressive Strength, 28 days minimum	250 kg/cm ²
• Cement content, sacks (50 Kg)	7.5 (Min)
• Water cement ratio, maximum	0.45
• Slump	25-75 min.
• Entrained air, percent	3 + 0.6
• Nominal size of aggregate	1½ Max.
- At least 35-days prior to the start of paving operations and after approval of all material to be used in the concrete, the Contractor shall submit for approval, the mix design he intends to use based on proportioned weighs of cement, air entrained agent, saturated surface dry aggregates and water. This mix design would be tested by the engineer and approval would not be granted unless the average 28-days compressive strength exceeds the minimum strength requirements by at least 15%. However, the Engineer may allow paving operation on the basis of 7-days strength.
- The cement content given in the foregoing table in minimum. If it is not sufficient to produce concrete of the compressive strength specified it shall be increased as necessary without additional compensation under the contract.
- The compressive strength of the concrete would be determined by testing standard cylinders made from concrete taken from the mixer. The making, curing and testing of the specimens would be in accordance with AASHTO T23-73.
- During the course of construction, when the source of any material for the concrete is to be changed, or if there is any variation in the quality of the materials furnished, additional tests and necessary adjustments in the mix shall be made as required to obtain the specified strengths.

16.5.2.3.4 Consistency

The required consistency of the concrete mixture shall be such that the mixture would be cohesive; uniform and plastic, permitting proper handling and finish. When deposit it shall not flow, but shall retain in a conical pile. There shall be minimum of segregation and surplus water during the process of handling and finishing. The slumps shall be determined by AASHTO T-119-74 except that during the course of construction control of concrete may be accomplished by the ball penetration as outlined in AASHTO T-183-72. 2.5cm ball penetration is considered equivalent to a slump of 5cm. The cement content shall be demi/died by means of a yield test in accordance with AASHTO T-121-74.

16.5.2.3.5 Placing of Concrete and Steel

16.5.2.3.5.1 General

The mixer shall be operated outside of the forms at all times except at location where the Engineer deems it not feasible to do so. When ordered by the Engineer, the subgrade shall be moisture as directed, prior to the placement of the subgrade paper such as polythene sheeting.

16.5.2.3.5.2 Concrete

- Concrete mixed in central plant shall be transported without delay to the position for laying and any concrete which in the opinion of Engineer has been mixed too long before reaching, the work would be rejected and shall be removed from the site. The concrete shall be deposited on the subgrade in succession batches for the full width between forms and in a manner, which would require as little re-handling. Spreading shall be done by an approved mechanical spreader in a manner that would prevent segregation and separation of the materials. Necessary hand spreading shall be done with shovels, not rakes. Workmen shall not be allowed to walk in the freshly mixed concrete with boots or shoes coated with earth or foreign substances. The amount of material deposited shall be sufficiently in excess of that required to form the pavement to the required cross-section after consolidation in order to provide a roll of concrete ahead of the front screed of the finishing machine for the full lengths of the screed.
- Concrete shall be thoroughly consolidated against and along the faces of all forms and along the full length and on both sides of all expansion joint assemblies by means of vibrators inserted in the concrete. Vibrators shall not be permitted to come in contact with a joint assembly, the grade or a side form. In no case shall the vibrator be operated longer than fifteen (15) seconds. Concrete shall be deposited as near to expansion and contraction joints as possible without disturbing them but shall not be dumped from the discharge bucket or hopper on to a joint assembly. The hopper is well centered on the joint assembly. Damage to joint assemblies caused by dumped concrete shall be repaired immediately as directed by the Engineer at Contractor's expense. Trucks delivering concrete shall not run on polythene sheeting nor shall they run on completed slabs until at (14) days after placing the concrete.
- Shall any concrete materials fall on or be worked into the Surface of completed slab, they shall be removed immediately by methods approved by the Engineer.
- Placement of concrete ahead of the initial spreader shall not be more than fifteen minutes ahead of final spreader strike-off. If concrete is placed, in one layer only, the placement of concrete shall not be more than twenty minutes ahead of the spreader strike off.
- In order to secure adequate compaction, the concrete is to be spread with, a machine above the finished level of the layer. Spreading, compacting and finishing operations are to be completed without delay.
- The total time taken from the addition of the water to the mix until the completion of the surface finishing operations shall not exceed thirty minutes' when shades or mix temperature exceeds twenty-seven-degree C or forty minutes less than twenty-seven-degree C. The mixing and placing of the concrete shall progress only at such a rate as to permit proper finishing, protecting and curing of the pavement.
- The additives shall be added to the concrete mix so as to ensure more setting time. The top of the forms shall be kept free from accumulation of concrete or foreign Material. The Contractor shall not permit the accumulation of laitance along the edge of a slab poured adjacent to one previously placed. Any accumulation of laitance shall be removed and replaced with fresh concrete. As soon as the side forms are removed, the edges of the slab shall first be inspected by the Engineer and any minor honey combed areas shall then be filled in with mortar composed of one part of cement and two parts of the aggregate under the supervision of the Engineer.

16.5.2.3.5.3 Steel Reinforcement

- All pavement reinforcement shall be placed as shown on the plans. All marginal bars, dowel bars, and tie bars required by the plans shall be held in proper position by sufficient number of metal bar supports or pins as approved by the Engineer. If the

center joint is to be sawed in lieu of placing the metal center strip, the tie bars may be installed mechanically by means of equipment and methods approved by the Engineer. The satisfactory placement of the tie bars shall depend upon the ability of the mechanical device to place the tie bars in their true position. The Engineer may require, when satisfactory placement is not obtained by mechanical means, that the tie bars be installed ahead of placing the concrete and that they be securely staked and tied if necessary, to hold them in their exact position. The use of removable devices, supporting the bars from the forms, will not be permitted.

- Following the placing of the concrete, it shall be struck off to conform to the cross section shown on the plans and to an elevation such that when the concrete is properly consolidated and finished, the surface of the pavement will be at the elevation shown on the plans. When reinforced concrete pavement is placed in two (2) layers, the entire width of the bottom layer shall be struck-off to such length and depth that the sheet of fabric or bar mat may be laid full length on the concrete in its final position without further manipulation. The reinforcement shall then be placed directly upon the concrete after which the top layer of (the concrete shall be placed, struck off and screeded. Any position of the bottom layer of the concrete which has been placed more than thirty (30) minutes without being covered with the top layer shall be removed and replaced with freshly mixed concrete at the contractor's expense. Plain concrete and bar reinforced bridge approach pavement may be placed in one (1) layer.
- Where two (2) layers of wire mesh reinforcement are required, as at bridge approaches, the bottom layer shall be supported in the required position with bar chairs. Separators shall be used for the top layer if the strike off cannot be properly used for the operation. Laps in adjustment sheets or mats of reinforcement shall be as shown on the plans. Laps parallel to the centerline of the pavement will not be permitted except for unusual widths of pavement lanes or for irregular areas. If the plans do not show dimensions for laps, the minimum lap either perpendicular or parallel of the centerline of the pavement shall be fifteen (15) centimeters. The adjacent sheets shall be fastened or tied together to hold all parts of the sheets in the same plane.
- Reinforcing steel shall be free from detrimental amounts of dirt, oil, paint, grease, loose mill scale, and loose or thick rust which could impair bond of the steel with the concrete.
- All other properties and other operations for fabrication and laying of steel bars will be according to Specifications.

16.5.2.3.6 Joints

16.5.2.3.6.1 General

- Joints shall be constructed exactly in accordance with the details shown on the plans and, Specifications and with the best of workmanship. Failure to construct the joints as called for and in the best possible manner, as determined by the Engineer, would be cause for suspension of work until the cause of the defective work is remedied.
- If removal of existing pavement of any type, is required to connect with the new pavement, and the termination of the removal is not at an existing joint, the new joint shall be made by sawing the existing pavement not less than. Five (5) cm deep before removal.

16.5.2.3.6.2 Expansion Joints

- The subgrade at Expansion joints shall be accurately trimmed to the required cross section and to the proper depth of the pavement.
- A string line shall be stretched between the pavement forms along the centerline of the joint. One half of the length of each dowel bar shall be painted in accordance with the

directions shown on the plans and then thoroughly coated with hard grease, or lubricant as approved by the Engineer, to prevent the concrete from bonding to that portion of the dowel.

- The entire joint assembly shall be of a type designated on the plans and shall be installed in such a position that the centerline of the joint assembly is perpendicular to the centerline of the pavement slab and the dowels lie parallel to the centerline of the slab. Finished joints shall not deviate more than six (6) mm in the horizontal alignment from a straight line. No plugs of concrete shall be permitted anywhere within the expansion space.
- A slip, sleeve of the dimensions shown on the plans shall be placed on the greased end of each dowel. The greased ends shall be free to slide in the dowel holder and shall extend in the direction as indicated on the plans. Any excess grease on the dowel holder shall be removed.
- The joint shall be securely staked or fastened in place prior to placing the concrete in a manner to ensure the joint and the dowel bars would remain in their proper position after the concreting and finishing operations are completed.
- Joints for pavement designed for two or less lanes of traffic shall be assembled and installed in one continuous piece or the connections between sections shall be made rigid and tight to prevent offsets in sections of the joints. The length of individual pieces of the expansion joint filler shall be not less than the width of one traffic lane of the pavement.
- The finishing machine shall be operated in a manner that would prevent displacement of the joint. If for any reason it is necessary to straighten a joint, any depression caused by this operation shall immediately be filled with fresh concrete, resiped and brought to the original crown in advance of the longitudinal finishers. Any fluid laitance caused by this operation shall be removed and replaced with fresh concrete.
- As the finishing machine approaches the joint on the first trip, the excess concrete shall be shoveled ahead and the tamper and each screed, in turn, shall be lifted over the joint. On the second trip of the finishing machine, the screed may be operated over the joint.

16.5.2.3.6.3 Contraction Joints

- Contraction joints shall be of the type and dimensions and at the spacing shown on the plans. Sawed contraction joints shall be cut by means of an approved concrete saw.
- The joints shall not be sawed until the concrete has hardened to the extent that tearing and releveling is precluded.
- All joints shall be sawed during the initial curing period and the sawing shall begin before the pavement starts shrinking and before uncontrolled cracking takes place.
- Any procedure which results in premature and uncontrolled cracking shall be revised immediately by adjusting the sequence of cutting the joints or the time interval involved between the placing of the concrete or the removal of the curing media and the cutting of the joints.
- In no case shall the pavement be left overnight without having the joints sawed.
- The joints shall be sawed at the depth, swing, and lines shown on the plans.
- Guidelines or devices approved by the Engineer shall be provided to ensure cutting in the joint in a straight line and perpendicular to the centerline of the pavement.
- The dust resulting from sawing shall be completely removed from the joint and adjacent areas by means of an air jet or a combination of air and water applied under pressure immediately after the joint has been cut, and before filling with joint compound.

- When the plan specifies that dowels be installed through contraction joints, the subgrade at the contraction joints shall be accurately trimmed to the required cross section and to the proper depth of the pavement.
- A string line shall be stretched between the pavement forms along the centerline of the joint.
- Each dowel shall be painted and thoroughly coated with hard grease or lubricant, in accordance with the direction shown on the plans or as approved by the Engineer, to prevent the concrete from bonding to that portion of the dowel.
- The entire joint assembly shall be of the type designated on the plans and shall be installed in such a position that the centerline of the joint assembly is perpendicular to the centerline of the slab and the dowels lie parallel to the slab surface and parallel to the centerline of the slab.
- The greased ends of the dowels shall be placed in the direction as indicated on the plans and shall be free to slide in the dowel holder. Any excess hard grease on the dowel holder shall be removed.

16.5.2.3.6.4 Longitudinal Joints

- Longitudinal joints shall be constructed in conformance with the details shown on the plans.
- When the fabricated steel strip is specified, it shall be held rigidly in place with an adequate number of pins driven into the subgrade to ensure that it would remain true to line and grade during concreting and finishing operations.
- On multiple lane pavement where longitudinal joints are constructed at the form line, an approved recessed form and tie bars would be required. The full depth fabricated steel strip designated by other longitudinal joints would not be permitted.
- When sawed joints are specified or used, suitable guidelines or devices shall be furnished to ensure cutting the longitudinal joint on the true lines as shown on the plans. The sawing of longitudinal joints shall be performed at a time that would preclude erratic or uncontrolled cracking. Sawed joints shall be filled with the type of joint compound indicated on the plans. The dust resulting from sawing shall be completely removed from the joint and adjacent areas by means of air jet or a combination of air and water applied under pressure immediately after the joint has been cut and before tilling with joint compound.

16.5.2.3.6.5 Construction Joints

- A butt construction joint shall be made perpendicular to the centerline of the pavement at the close of each day's work and also when the process of depositing concrete is stopped for a length of time such that, in the opinion of the Engineer, the concrete would have taken its initial set. This joint shall be formed by using a clean plank-header having a nominal thickness of five cm, a width of not less than the thickness of the pavement and a length of not less than the width of the pavement. The header, shall be cut true to the crown of the finished pavement and shall be accurately set and held in place in a plane at right angles to centerline and perpendicular to the surface of the pavement.
- The top surface of the header shall be protected with steel as approved by the Engineer. On the face along with the center of the header there shall be fastened a trapezoidal piece of metal or wood the full length of the header, five cm wide and at least twenty-five mm in depth to form a grooved joint. The header shall have drilled holes to accommodate the dowel or tie bars hereinafter specified. Upon resumption of

work. and surplus concrete remaining upon the subgrade shall be removed. The header shall then be carefully removed and fresh concrete deposited against the old in such a manner as to avoid injury to the edge of the old concrete. The fresh concrete shall be vibrated into the groove in a manner to ensure an interlocking joint.

- Dowel bars or load transfer devices shall be used in all construction joints in accordance with the details shown on the plans. If no such details are shown on the plans, tie bars as provided for the longitudinal joint, and spaced at forty-five cm centers shall be placed across the joint in a plane parallel to the surface of the pavement approximately midway between the top and bottom surfaces of the pavement. The edge of the joint shall be grooved edged and sealed with the material used for sealing expansion and contraction joints.
- No construction joint shall be placed within three meters of an expansion, contraction or other construction joint.

16.5.2.3.6.6 Sealing Joints

Materials: Joints shall be sealed with material of the type designated on the plans.

16.5.2.3.7 Consolidation and Finishing

16.5.2.3.7.1 Consolidation

- After being spread and struck-off as provided in sub-item "Placing Concrete", the concrete shall be further struck-off and consolidated with an approved finishing machine to such an elevation that when finishing operations are completed, the surface would conform to the required grade and crown. The finishing machine shall operate over the entire surface at least twice, the first time with file finishing machine tamper and both screeds in operation. A uniform roll of concrete approximately fifteen cm above the pavement grade shall be maintained ahead of the front screed for its entire length during the first trip over with the finishing machine. Excessive tamping or finishing resulting in bringing an excess of mortar to the surface would not be permitted.
- After the last pass of the finishing machine, a mechanical longitudinal finisher shall be operated over the concrete surface. The forward motion of the longitudinal finisher shall be adjusted that the screed would pass over each portion of the surface at least twice. The longitudinal finisher shall be operated in a manner that would prevent excessive slumping of the concrete at the form lines or the metal center strip or the loss of the crown of the pavement. If necessary or when ordered by the Engineer, the finisher shall be operated in one direction only or shall be prepared from only the form to the centerline in order to ensure that the proper cross section of the pavement is obtained. The leading edge of the screed shall clear the forms upon completion of each transverse pass in order to clear the pavement surface of any laitance or thin mortar.
- In general, the addition of superficial water to the surface of the concrete to assist in finishing operations would not be permitted. If the application of water to the surface is permitted by the Engineer, it shall be applied as a fog spray by means of approved spray equipment.
- As an alternative to the longitudinal finisher, the Contractor may use a machine composed of a cutting and smoothing float, or floats, suspended from and guided by a rigid frame. The frame shall be carried by four or more visible wheels riding on, and constantly in contact with, the side forms.

- When directed by the Engineer; following one of the preceding methods of longitudinal finishing, long handled floats having blades not less than one and half meters in length and fifteen cm in width shall be used to smooth and fill in open texture areas in the pavement, long-handled floats shall not be used to float the entire surface of the pavement in lieu of, or supplementing, one of the preceding methods or longitudinal finishing.
- When the longitudinal finishing has been completed the entire surface shall be tested with straightedges not less than three meters in length. The straightedges shall be operated parallel to the pavement centerline starting at the centering progressing towards the forms. Advance along the pavement shall be in successive stages of not more than one half the length of the straightedges. All laitance, surplus water, and inert material shall be removed from the surface. All high places shall be worked down and all low places filled combined operations of floats and straight edge until no irregularities exist. The proper crown of the pavement shall be maintained throughout the operations.
- After floating and straightening has been completed, the concrete shall be finished by using a belt made of canvas, rubber, in to the approved belting not less than fifteen cm in width, nor less than sixty cm longer than the width of the pavement. This belt shall be worked with a longitudinal and crosswise motion. Care shall be exercised in the use of, the belt to ensure that the edges of the belt do not dig into the surface, of the concrete or work the crown out of the pavement. Either machine belting or hand belting would be permitted.
- As soon as all excess moisture has disappeared. and while the concrete is still plastic enough to make a granular surface possible, a drag shall be used which shall consist of a seamless strip of damp burlap or cotton fabric, which shall produce a uniform surface of gritty texture after dragging it longitudinally along the full width of pavement. For pavement five meters or more in width, the drag shall be such that a strip or burlap or fabric at least one and half meters wide is in contact with the full width of is in contact with the full width or pavement surface while the drag is used. The drag shall maintain in such condition that that resulting surface is of uniform appearance and reasonably free from grooves over two thin in depth, as determined by the Engineer. Drags shall be maintained clean and free from encrusted mortar. Drags that cannot be cleaned shall be discarded and new drags substituted.
- After dragging the surface with burlap, the concrete over the expansion joint filler shall be completely removed and the joint finished. The edges of the concrete at expansion joints shall be finished with an edge to the radius shown on the plans. The exposed edge of the pavement shall be finished with an edger to a radius of six mm. Any tool marks appearing on the slab adjacent to the joints or edge of slab shall be eliminated by dragging the surface. In doing this the rounding of the corner of the, slab shall not be disturbed.

16.5.2.3.7.2 Finishing

- Unless otherwise specified, hand finishing methods would not be permitted except under the following conditions.
- In the event of breakdown of the mechanical equipment hand methods may be used to finish the concrete already deposited on the grade; when the breakdown occurs, and no additional concrete shall be placed until such equipment is repaired to the satisfaction of. the Engineer.

- Narrow widths, or areas of irregular dimensions where operation of mechanical equipment is impractical as determined by the Engineer, may be finished by approved hand methods.
- Short lengths of pavement, such as bridge approach pavement, where the operation of mechanical equipment is impractical may be finished by approved hand methods.
- Concrete, as soon as placed, shall be struck-off and screed. An Approved portable screed shall be used. A second screed shall be provided for striking off the bottom layer of concrete if reinforcement is used.
- The screed for the surface shall be at least one meter longer than the maximum width of the slab to be struck-off. It shall be of approved design, sufficiently rigid to retain its shape, and be constructed either of metal or other suitable material shod with metal.
- Consolidation shall be attained by the use of a suitable vibrator or other approved equipment.
- In operation the screed shall be moved forward on the forms with a combined longitudinal and transverse shearing motion, moving always in the direction in which the work is progressing and so manipulated that neither end is raised from the side forms during the striking off process. If necessary, this shall be repeated until the surface is of uniform texture true to grade and cross section, and free from porous areas.
- After the concrete has been struck-off it shall be further smoothed, trued, and consolidated by means of a longitudinal float. The hand operated longitudinal float shall be not less than three and half meters in length and fifteen cm in width, properly stiffened to prevent flexing and warping. The longitudinal float, operated from foot fridges resting on the side forms and spanning but not touching the concrete, shall be worked with a sawing motion, while held in a floating position parallel to the road centerline and passing gradually from one side of the pavement to the other, movement ahead along the centerline of the pavement shall be in successive advances of not more than one half the length of the float, any excess water or soupy material shall be wasted over the side forms on each pass.
- At the option of the Engineer, the long-handled floats having blades not less than one and one-half meters in length and fifteen cm in width may be substituted for the hand operated longitudinal float.
- All other operations after this substitution for the mechanical equipment shall be performed in the manner previously described.
- Concrete operation shall be performed only in daylight under no circumstances shall concrete pavement placed or finished at night.

16.5.2.3.7.3 Removing Form

Unless otherwise provided, forms shall not be removed from freshly placed concrete until it has set for at least twelve hours, except auxiliary forms used temporarily in widened areas. Forms shall be removed carefully so as to avoid damage to the pavement, After the forms have been removed, the sides of the slab shall be cured as specified for the surface. Major honeycombed areas would be considered as defective work and shall be removed and replaced at the Contractor's expense, as directed by the Engineer. Any area or section so removed shall not be less than three meters in length not less than the full width of the lane involved. When it is necessary to remove and replace a section of pavement, any remaining portion of the slab adjacent to the joints that is less than three meters in length, shall also be removed and replaced.

16.5.2.3.8 Protecting and Curing Concrete Pavement

16.5.2.3.8.1 Initial Curing

- As the surface of the newly-laid pavement is progressively finished, the initial curing and protection operations shall be started.
- Upon completion the finishing operation and while the surface of concrete is still moist, but no free water remains, a liquid curing membrane. approved by the Engineer shall be applied to the exposed surface of the pavement at the rate not less than one liter per three and two-thirds square meters of surface area when mechanical pressure distributors are used. The curing membrane, except on irregular areas shall be applied by means of approved self-propelled mechanical pressure distributors or approved hand sprays. Satisfactory means shall be provided for thoroughly mixing the curing membrane compounded before and during its used. The mechanical spraying equipment may be either a full width spray bar equipped with multiple nozzles or a traversing spray which travels from one edge of the pavement to the other. In either case the path of adjacent nozzles or passes of the traversing spray shall overlap a minimum of one-half the width of the spray pattern so that all portions of the surface shall receive double applications from adjacent nozzles or passes. The pinging, pressures and distribution arrangement shall be correlated with the forward speed to provide adequate and uniform coverage of the pavement at not less than the minimum rate required. Irregular areas to which the mechanical distributor cannot be adapted may be covered with hand sprays.
- When hand sprays are used, the curing membrane shall be applied in two applications, each at a rate: of not less than one liter per five square meters of surface area so as to provide a total rate of application of one liter per two- and one-half square meters of surface area the path of the spray on the second application shall be at right angles to the path of the spray on the first application. When hand operated sprays are permitted, the equipment supplying the pressure to the spray nozzle shall be capable of supplying a constant and uniform pressure to provide uniform and adequate distribution of the curing membrane compound at the rate required. If from any cause, such as rainfall soon after its application, the curing membrane is damaging the Contractor shall immediately apply another application of curing membrane to the surface of the pavement. The rate of application for the replacement membrane shall be the same as for the original membrane.
- Unless otherwise directed by the Engineer, immediately following the application of the curing membrane, an approved shade canvas shall be placed approximately thirty cm above the pavement surface. The shade-canvas shall be constructed of materials and in a manner approved by the Engineer. In no case shall any portion of the shade-canvas come in contact with the pavement. The initial curing shall be continued for a period of twenty-four hours from the time the curing membrane is applied.
- When forms are removed, whether during the initial of the final curing period, the edges of the pavement shall receive curing membrane at the rate of coverage specified for the pavement surface.
- The curing Membrane may be applied to the vertical edges of the pavement by means of hand sprays or by nozzles attached to the mechanical distributor, but the edges of the pavement shall be covered with curing membrane at the rate specified within thirty minutes after removal of the forms.
- When Cold-Poured joint compound is used, all joints shall be sawed during the initial curing period. The shade-canvas may be moved at joint locations for short periods of time to permit the sawing. Before being sealed, the joints shall be thoroughly cleaned of all loose saw dust, laitance, dirt, other foreign matter and free of Water. As the

method of final curing is different from that of the initial curing, the cleaning and sealing of joints shall be performed immediately following the removal of the shade-canvas at the end of the initial curing and prior to the application of the polyethylene sheeting.

- When hot poured joint compound is used, the joints shall be sawed, cleaned and filled with jute or other acceptable protective material in the same time sequence as for cold-poured joints.
- In no case shall any portion of the concrete pavement be exposed to the direct rays of the sun for more than one hour.
- Following jointing operations curing membrane shall be applied to the joint area at the rate specified for the pavement surface.

16.5.2.3.8.2 Final Curing

- Upon completion of the initial curing period and after the shade canvas has been removed and jointing operation has been completed, the Pavement shall be completely covered with White Opaque Polyethylene Film as specified, in AASHTO M 171. Adjoining sheets shall be lapped a minimum of forty-five cm; The sheeting shall be in place in a manner approved by the Engineer.
- Final curing shall be continued until the concrete reaches an age of fourteen days. During this period, the curing membrane kind polyethylene film shall be protected from damage from any cause. Any damage from one cause shall be immediately repaired by the Contractor at his expense. No traffic, including workmen and pedestrians, shall be allowed on the surface of the pavement until the expiration of the fourteen-day curing period.
- When concrete is being placed during the time that the air temperature may be expected to drop below fifteen degrees C. a sufficient supply of burlap, straw, hay or other suitable blanketing material shall be provided along the work to protect the concrete and maintain a minimum temperature of fifteen degrees C in the concrete as measured on the surface of the pavement. An approved moisture barrier such as wet burlap or plastic sheeting shall be placed on the concrete prior to placing the blanketing material. This type of cure shall be maintained for a period of seventy-two hours as the initial cure. After the initial cure as specified above final cure as specified above may be used. The final cure shall be maintained for a period of fourteen days, thus making a seventeen-day curing period for cold-weather concreting.

16.5.2.3.9 Surface Tolerance

- As soon as the concrete has hardened sufficiently, the pavement surface shall be tested with a three-meter straightedge or other specified devices. Areas showing high spots of more than three mm, but not exceeding twelve mm in three meters between any two contact points, shall be marked and immediately ground down with an approved grinding tool to a tolerance of less than three mm as described above. Where the departure from correct cross section exceeds twelve mm, the pavement shall be removed and replaced by and at the expense of the Contractor.
- Any area or section so removed shall be not less than three meters in length not less than the full width of the lane involved. When it is necessary to remove and replace a section of pavement, any remaining portion of the slab adjacent to the joints that is less than three meters in length, shall also be removed and replaced at the Contractor's expense.

16.5.2.3.10 Tests for Thickness of Pavement and Degree

16.5.2.3.10.1 Thickness of Pavement

- The Employer would not be liable for payment of any excess in thickness or depth of pavement. During the progress of the work, the thickness or depth of pavement would be determined by the Engineer from cores cut from the concrete pavement by the Contractor. The cost of cutting and recovering all the cores described in this clause and the following paragraph shall be deemed to be included in the Bill of Materials and Prices for Portland Cement Concrete Pavement entered by the Contractor in the Bill of Materials and Prices.
- Unsatisfactory work shall be repaired, replaced, or would be paid for at an adjusted price, as follows: -
 - One 15 cm diameter core would be removed by the Contractor from each lane, at such locations as the Engineer may direct and shall represent not more than 1000 SM of a pavement area, a lane shall be considered the pavement surface between longitudinal joints, or a longitudinal joint and pavement edge.
 - If any core measurement is deficient more than 6.5 mm from the required thickness a core measurement shall be taken at each 30m interval in both directions longitudinal from the first deficient core in the same lane, as defined herein until the thickness of the pavement is found to be not more than 6.5 mm deficient from the required thickness. Each deficient core shall be considered as representing the condition in the same lane or longitudinal section, as above defined, for a distance of 15m, in each direction longitudinally from the core.
 - Sections of pavement which are deficient in thickness, as determined by cores, by an amount more than 1.3 cm shall be removed and replaced with pavement of the specified thickness at the expense of the Contractor. The removal and replacement shall start at the determined point of deficiency and proceed longitudinally as hereinafter specified, until the pavement is to be not more than 6.5 mm deficient from the required thickness. The old reinforcing steel shall be left extended a sufficient distance so, as to allow the new reinforcement steel to be lapped with the old, the required distance to be welded to the satisfaction of the Engineer.
 - The removal and replacements of pavements shall extend transversely the full width each lane in which such deficiency is found.
 - All pavements within two meters of the deficiency of spot shall be removed except that when any joint is more than two meters, all pavements shall then be removed to the next joint.
 - Sections of pavement which are deficient in thickness, as determined by measurement of cores in accordance with AASHTO T-148-49, by an amount more than 6.5 mm, but not more than 1.3 cm, would be paid for at an adjusted price as specified in Table Below: -

Thickness	Proportional Part of contract of Contract Price to be allowed
3.00mm to 6.5 mm	95 %
6.5 mm to 13 mm	75%

Table 61, Deficiency Thickness as Determined from Core

16.5.2.3.10.2 Degree of Compaction

- The cores that have been cut from the concrete pavement according to the requirements of (i) above shall be examined by the Engineer's Representative to check

the degree of compaction achieved through the slab and to check the effectiveness or the bond between the top and bottom course concrete.

- Shall any core reveal that any part of the slab has not been adequately compacted by revealing honeycombed or segregated concrete and shall the bond between the top and bottom layers of concrete be such that a plane of weakness is present, then additional cores shall be taken to check the areas of defective concrete pavement according to the procedure laid down in (i) above for determining the areas of concrete pavement deficient in compaction.
- Any areas of defective pavement concrete so found shall be replaced with new concrete in accordance with this section at Contractor's own expense.
- The Engineer reserves the right to carry out crushing tests on any or all of the concrete cores taken in accordance with this clause, and shall these tests shown that any area of pavement concrete has failed to meet the strength requirements of the Specifications, then such areas of concrete shall be removed and replaced with new concrete, mixed, compacted and finished to the requirements of this section at Contractor's own expense.

16.5.2.3.10.3 Refilling of Holes

Holes in the pavement created by the cutting of cores shall be thoroughly coated on the inside with a neat cement grout and shall then be filled with concrete of the same mix as shown in the pavement. The filling shall be in two equal layers and each shall be rodded 25 times to its full depth. The surface shall be finished flush and boomed. The surface shall be kept thoroughly wet for 72 hours thereafter.

16.5.2.3.10.4 Replacement of Defective Concrete

Any concrete not complying with the Specifications shall be cut out and replaced in accordance with the Specifications over the full width of the slab between longitudinal construction joints and over a length extending between two transverse joints each of a type other than a warping joint.

16.5.2.3.10.5 Concrete Lug Anchors

"Concrete Lug Anchors" shall be constructed in accordance with the dimensions and notes and at the locations shown on the plans. Unless otherwise indicated on the plans; the class, composition, consistency, proportioning, hatching, mixing- and curing' of the concrete used in Concrete lug anchors shall conform to the same requirements as the concrete pavement. Reinforcing Steel, concrete and excavation for lug anchors shall be subsidiary to the Bill of Quantities item "Concrete Lug Anchors".

16.5.2.4 Measurement and Payments

16.5.2.4.1 Measurement

- The unit of Measurement for payment shall be the cubic meters of the completed and accepted Portland Cement Concrete Pavement, as measured in place. The number of cubic meters of the completed Portland Cement Concrete Pavement shall be determined by the length measured along the center line and upon the surface of the road, items the width as shown on the Drawings plus the areas of any widening on curves, turnouts and intersection, authorized and measured separately. Measurement

of pavement thickness would be ensured by erecting shutters for screening concrete at required level.

- The unit of Measurement for bridge Approach Slabs shall be the square meters of the area actually constructed in accordance with the Drawings or as directed in writing by the Engineer.
- Concrete Lug Anchors shall be measured by the linear meters in place, the measuring being made along the centerline of the concrete lug anchor transverse to the pavement centerline. No Measurement would be made of unauthorized areas or for extra thickness.

16.5.2.4.2 Payments

Payment shall be made under: -

Pay Item No.	Description	Unit of Measurement
16.5.2.4.2.1	Plain Cement Concrete Pavement of specified strength	Per Cu.m. (m ³) or Per 100 cft (ft ³)
16.5.2.4.2.2	Reinforced Cement Concrete Pavement of specified strength	Per Cu.m.(m ³) or Per 100 cft (ft ³)
16.5.2.4.2.3	Concrete Lug Anchors	Per meter or Per foot
16.5.2.4.2.4	Furnishing, Fabrication and planning of steel deformed bars of Grade 40	Per Metric Ton
16.5.2.4.2.5	Furnishing, Fabrication and planning of steel deformed bars of Grade 60	Per Metric Ton

16.6 Structures

16.6.1 General

This item contains a general description of the specific items of work, the materials, construction requirements, and methods of Measurement and payment for all concrete structures including bridges, culverts, piles, composite structures including bridge, culverts, piles, composite structures of concrete such as barriers and steel, pre-stressed and post tensioned girder and all brick and stone masonry structures built in conformity with the lines, grade, dimensions in conjunction with any instructions issued by the Engineer. Materials, equipment, workmanship and construction methods applied in the work shall conform to the requirements laid down herein and shall also follow the best modern construction practices with the approval of Engineer. This item shall also include construction of certain structural features and incidental items which are either common to all types of structures or which may apply to any of them.

16.6.2 Materials

The materials used shall be those prescribed for several contract items which are to constitute the complete structure.

16.6.3 Construction Requirements

16.6.3.1 Clearing of Site

- The Contractor shall clear the sites for proposed structures of trees, bushes, stumps and debris, in accordance with 3.7.1.1 "Clearing and Grubbing" of Book-2. Special clearing of site such removal of existing buildings, concrete pavement shall be paid for at the prices tendered for these items, but where no such prices are provided for, all costs in connection with the special clearing shall be deemed to be included in the price tendered for various items of the structures in the Bill of Quantities.
- Removal or relocation of public or private utilities such as telephone or telegraph lines, power lines, underground cable lines, sewer and water supply lines, railway tracks and their appurtenances etc., shall be arranged by the Employers Representative with the concerned Government Agency, utility companies and person involved. The Employer shall bear the costs of relocating such utilities.

16.6.3.2 Foundation Data

Foundation data including the location of all bore-holes together with the records of ground conditions encountered have been obtained from soil investigation by test boring, test pits or other sources. It is Engineer's responsibility. to ensure by additional investigations through the Contractor at the very, beginning of construction work that the foundation levels given in the Drawing coincide with the local requirements.

16.6.3.3 Alignment and Grades

- All structural members such as prefabricated girders, cast in situ deck slab, cast in situ super structures, bridge rails including curbs, wheel guards, safety fencing shall. be so constructed: and placed, that finished vertical alignment and grade shall be as shown on the Drawings.

- Rails, Sidewalks and curbs on the curved portion of structures shall be constructed, as far as possible after the completion of the entire super structure slab. In such cases, the height of rail, sidewalk and/or curb may vary with respect to the grade line of the slab in order to produce the desired appearance.

16.6.3.4 Erection Method

Before moving any construction equipment to the site, the Contactor shall submit for approval an outline of the method he proposes to follow in the erection of structure.

16.6.3.5 Navigable Streams

The channel of navigable streams shall be kept clear for safe passage of water. The Contractor shall provide and maintain all necessary light and signals in accordance with the navigation authority's requirements. The Contractor shall pay due regard to the hazard of the river Bow during period of intense rainfall. All material deposited in the channel shall be removed to the required depth and clearance lines at the Contractor's expense.

16.6.3.6 Concreting

The concrete of Bridges or culverts shall be poured and surface finished and cured as per requirements conforming to Section 'structures' of this chapter and chapter 6 'Concrete'.

16.6.3.7 Final Clearing

Upon completion of structures, the Contractor shall clean the site conforming to requirements given in subsection 'concrete' of Section 'structures' of this chapter.

16.6.3.8 Public Bodies / Services Authorities

The Contractor's methodology shall meet all statutory requirements of the railway, irrigation or Service Authorities and his rates shall include for all costs meeting these requirements.

16.6.3.9 Opening to Traffic

Bridges or slab or box culverts having decks constructed with Portland Cement concrete shall remain closed to all traffic and Contractor's Equipment subject to the results of tests made of the concrete but not less than twenty-eight days after the placing of concrete. The above time of opening to traffic is applicable when temperature is above ten degrees. The time of opening to traffic shall be increased at the discretion of the Engineer. In any event bridges or culvert with concrete decks shall not be opened to traffic without the approval of the Engineer.

16.6.4 Measurement and Payment

16.6.4.1 Measurement

The quantities of various pay items of Bridges and Culverts which constitute the completed and accepted structures shall be measured for payment according to the plans and Specifications for the several pay items appearing in the Bill of Quantities and in terms of the prescribed units provided for the several pay items. Only accepted work shall be included for

payment and the measured quantity shall be based on the dimension of Component as shown on the plans or as directed in writing by the Engineer.

16.6.4.2 Payment

The quantities measured as provided above shall be paid for at the unit prices bid for the several pay items appearing in the Bill of Quantities which payment and prices shall be full compensation for furnishing, preparing, fabricating, transporting, placing and erecting all material for the complete structures; for all labour, equipment, tool and all other items necessary for the completion of work. Such payment shall constitute full payment for completed structures and no allowance would be made for cofferdam construction, form lumber, false-work and other incidental expenses.

16.6.5 Form Work, False Work and Centering for Bridges

16.6.5.1 Description

This work shall consist of the designing, providing, erecting supplying, construction and removing of falsework / formwork of sufficient strength with all necessary bracings, fasteners etc. which would provide the necessary rigidity to support the loads imposed. and produce a structure, finished to the lines and grades indicated on the plans or as required by the Engineer.

16.6.5.2 Material Requirements

- Timber and lumber to be used for false-work shall be of sound lumber and comply with the requirement in AASHTO M 168.
- Structural steel to be used for false-work shall comply with the requirements of Standard Specifications of Structural Steel AASHTO M 183. Reinforcing steel if it is to be used for false-work shall comply with the requirements of AASHTO M 31 - 82. Concrete when used shall conform to given in Chapter-6 "Concrete". of this volume and hereafter under section 'concrete'; of this chapter under Section "Structures.

16.6.5.3 Construction Requirement

16.6.5.3.1 False Work Design and Drawings

- Detailed working drawings and backup calculations of the false-work shall be furnished by the Contractor to the Engineer. No false work construction shall start until the Engineer has reviewed and approved the drawings. The Contractor shall provide sufficient time for the Engineer to complete this review. Such time shall be proportionate to the complexity of the false-work design and in no case shall be less than one week.
- The Contractor may revise the false-work drawings at any time provided sufficient time is allowed for the Engineer's review before construction is started on the revised portions.
- Assumptions used in design of the false-work shall include but not be limited to the following: -
- For designing false work and centering, a weight of 2,400 kg. per cubic Meter shall be assumed for green concrete. All falsework shall be designed and constructed to provide the necessary rigidity and to support the: loads without appreciable settlement or

deformation. The Engineer may require the Contractor, to employ screw jacks or approved wedges to take up any settlement in the formwork either before or during the placing of concrete.

- The entire superstructure cross-section, except railing shall be considered to be placed at one time, except when in the opinion of the Engineer a portion of the load is carried by girders previously cast and having attained a certain strength.
- False-work, which cannot be founded on a satisfactory footing; shall be supported on piling, which shall be spaced, driven; and removed in an approved manner. The loading used on timber piles shall not exceed the bearing value for the piles and in no case exceed ten tons per pile.
- Soil bearing values and soil conditions (Wet and dry) shall be designated by the Contractor on the false-work drawings. False-work footings shall be designed to carry the loads imposed upon them without exceeding estimated soil bearing values or allowable settlements.
- False-work shall be set to give the finished structure; the Camber specified or indicated on the Drawings.
- Arch centering shall be constructed according to the 'approved centering plans. Provisions shall be made by means of suitable wedges, sand boxes, or other devices for the gradual lowering of centers to render the arch self-supporting When directed, Centering shall be placed on approved jacks in order to take up and correct any slight settlement, which may occur after the placing has begun.
- The maximum loading and deflections; used on 'jacks, brackets, 'columns, and other manufactured devices shall not exceed the Manufacturer's recommendations. If requested by the Engineer, the Contractor shall furnish catalogues or other data verifying these recommendations.
- If the concrete is to be pre-stressed, the false-work shall be deigned to support any increased or readjusted loads caused by the pre-stressing forces.
- Joints supporting slabs and overhangs shall be Considered as false-Work and designed as such.
- For the construction of false work over and adjacent to roadways where false work openings are required for maintaining traffic, the contractor shall provide any additional features for the work needed to ensure that the false-work would be Stable if subjected to impact by vehicles.
- The false-work design at the locations. where said openings ire Snared shall include but not be limited to the following minimum provisions: -
- Each exterior stringer in a span shall be securely anchored to the false-work cap or framing.
- Adequate members shall be used during all stages of false-work construction and removal over or adjacent to public traffic.
- False-work members shall be at least thirty cm clear of temporary protective railing members.
- The false-work drawings shall include a superstructure placing diagram showing proposed concrete placing sequence and, construction joint location, except that where a schedule for placing concrete is shown on the contract ohms, no deviation would be permitted there from unless approached in writing by the Engineer.
- The false-work drawings shall show any pedestrian openings, which are required through the false-work.
- Anticipated total settlements of False-Work mid forms Shall be indicated the Contractor On the false-work drawings. These shall include false-work fooling settlement and joint take-up. Anticipated settlement over two ems would not be allowed unless permitted

'by the Engineer. Deck slab forms between girders shall be constructed with no allowance for settlement relative to the girders.

- Detailed calculations by the Contractor showing the stresses, deflections and camber necessary to compensate for said deflections in all load. supporting mamba-shall be included in the working drawings.
- After approving the Contractor's false work deflection camber, the Engineer would furnish to the Contractor the amounts of camber necessary to compensate for vertical alignment or anticipated structures deflection, if this is not shown on the drawings. The total camber used in constructing false-work shall be the sum of the aforementioned cambers."

16.6.5.3.2 False Work / Form Work Construction

- The false-work shall be constructed to conform to the false-work drawings. The materials used in the false-work construction shall be of the quantity and quality necessary to withstand the stresses imposed. The workmanship used in false-work construction shall be of such quality that the false-work would support the load imposed on it without excessive settlement or take-up beyond that shown on the false work drawings.
- False-work shall be founded on footings, capable of supporting the loads imposed on it.
- When false-work is supported on piles, the piles shall be driven to a bearing value, equal to the calculated pile loading as shown on the false-work drawings.
- Suitable jacks or wedges shall be used in connection with false-work to set the forms to their required grade and to take up any excessive settlement in then false-work either before or during the placing of concrete.
- The Contractor shall, provide tell-tales attached to the soffit forms easily readable and in enough systematically. Placed location to determine the total settlement, of the entire portion of the structures where concrete is being placed.
- Shall events occur, including settlements that deviate; more the 2 ems from those indicated on the false-work drawings, which in the opinion of the Engineer would prevent obtaining a structure conforming to the requirements of these Specifications, the placing of concrete shall be discontinued until corrective measures arc provided to entire satisfaction of the Engineer. In the event, satisfactory measures are not taken to correctness of excessive settlements, the Contractor shall not be relieved of responsibility for conforming to the requirements of these Specifications.
- Concrete forms shall be constructed and maintained so as to prevent warping and the opening of joints due to the shrinkage of the lumber and shall be true to the dimensions, lines and grades of the structure and with the sufficient strength, rigidity, shape and surface smoothness as to leave the finished works true to the dimensions shown on the Drawings or required by the Engineer and with the surface finish as specified.
- Forms for exposed surfaces shall preferably be lined with metal, plywood, or other approved material, or may with the Engineer's permission be made of dressed lumber of uniform thickness. Forms shall be filled at all sharp corners (Minimum two (2) cm triangular fillets) and shall be given a level or draft in the case of all projections, such as girders and copings, to ensure easy removal.
- Form fasteners consisting of form bolts, clamps or other devices shall be used as necessary to prevent spreading of the forms during concrete placement. The use of ties consisting of twisted wire loops to hold forms in position will not be permitted. Metal ties or anchorage within the forms shall be so constructed as to permit their removal to a depth of at least five (5) cm from the face without injury to the concrete.

- Fitting for metal ties shall be of such design that, upon their removal, the cavities that are left will be of the smallest possible size. The cavities shall be filled with cement mortar and the surface left sound, smooth, even and uniform in color. Anchor devices may be cast into the concrete for later use in supporting forms or for lifting precast members. The use of driven types of anchorages for fastening forms or form supports to concrete will not be permitted.
- The inside surfaces of forms shall be cleaned of all dirt, mortar and foreign material. Forms, which will later be removed, shall be thoroughly coated with form oil prior to use. The form oil shall be commercial quality form oil or other approved coating which will permit the ready release of the forms and will not discolor the concrete. All exposed surfaces of similar portions of a concrete structure shall be formed with the same forming material or with materials that produce similar concrete surface textures, color and appearance.
- Concrete shall not be deposited in the forms until all work in connection with constructing the forms has been completed, all materials required to be embedded in the concrete have been placed for the unit to be poured and the Engineer has inspected and approved said forms and materials.
- The rate of depositing concrete in forms shall be such as to prevent deflections of the forms or form panels in excess of the deflections permitted by these Specifications. Maximum deflection allowed due to prop settlement is 5 mm and due to bending of shutters is three (3) mm, when measured with 3-meter straight edge.
- Forms for all concrete surfaces, which will not be completely enclosed or hidden below the permanent ground surface, shall conform to the requirements herein for forms for exposed surfaces. Interior surfaces of underground drainage structures shall be considered to be completely enclosed surfaces.
- Formwork for concrete placed under water shall be watertight. When lumber is used, this shall be planed and tongued and grooved.
- Forms for exposed concrete surfaces shall be designed and constructed so, that the formed surface of the concrete does not undulate excessively in any direction between studs, joists, form stiffeners, form fasteners or wales. Undulations exceeding either two (2) mm or 1/270 of the center to center distance between studs, joists, form stiffeners, form fasteners or wales will be considered to be excessive. Should any form or forming system, even though previously approved for use, produce a concrete surface with excessive undulations, its use shall be discontinued until modifications, satisfactory to the Engineer have been made. Portions of concrete structures with surface undulations in excess of the limits herein may be rejected by the Engineer.
- Forms shall be set and maintained true to the line designated until the concrete is sufficiently hardened. Forms shall remain in place for periods, which shall be determined, as herein specified. When forms appear to be unsatisfactory in any way, either before or during the placing of concrete, the Engineer will order the work stopped until the defects have been corrected.
- The shape, strength, rigidity, water-tightness and surface smoothness of reused forms shall be maintained at all times. Any warped or bulged lumber must be resized before being reused. Forms that are unsatisfactory in any respect shall not be reused.
- For narrow walls and columns, where the bottom of the form is inaccessible, the lower form boards shall be adjustable so that they may be removed for cleaning out extraneous material immediately before placing the concrete.

16.6.5.3.3 Removing False Work / Form Work

- In the determination of the time for the removal of falsework and forms, consideration shall be given to the location and character of the structure, the weather and other conditions influencing the setting of the concrete and the materials used in the mix.
- Unless otherwise shown on the drawings or permitted by the Engineer, false work supporting any span of a 'simple span bridges shall not be released before 14 'days after the last concrete, excluding concrete above the bridge deck, has been placed. False-work supporting any span of a Continuous or rigid frame bridge shall not be before 14 days after the last concrete, excluding concrete above the bridge deck, has been placed in that span and in the adjacent portions of each adjoining span where false-work is to be released.
- False-work supporting deck. overhangs and deck slab, between girders shall not be released until seven days after the deck concrete has been placed.
- In addition to the above requirement, no false-work for bridges shall be released until the supported concrete has attained a compressive strength of at least eighty of the required twenty-eight days' strength.
- False-work for cast-in-place pre-stressed portions of structures shall not be released until after the pre-stressing steel has been tensioned.
- All False-Work materials. shall be completely removed. False-work piling shall be removed at least sixty cos below the surface of the original-ground Stream bed. 'When false-work piling is driven within the limits of ditch or channel exci4cocatat the false-work piling within such areas shall by removed to at least sixty cm below the bottom and side slopes of said excavated area.
- All debris and refuse resulting from work shall be removed and the premises left in a beat and presentable condition.
- If field operations are not controlled by beam or cylinder tests, the following periods, exclusive of days when the temperature is below five (5) °C, for removal of forms and supports shall be used as a minimum subject to the approval of the Engineer: -

• Arch Center	14 days
• Centering Under Beams	14 days
• Supports under Flat Slabs	14 days
• Floor Slabs	14 days
• Vertical Wall Surfaces	24 Hours
• Columns	24 Hours
• Side of Beams	12 Hours
• Top Slabs R.C. Box Culverts	14 days
- Side forms for cast-in-place beams, girders, columns, or other members where the forms do not resist dead load, bending shall remain in place for at least forty (40) hours after placing concrete for the members. Side forms for precast members may be removed the next day after placing concrete therein.
- If high early strength cement is used or by the use of additional cement, these periods may be reduced as directed.
- When field operations are controlled by cylinder tests, the removal of forms, supports and housing and the discontinuance of heating and curing (where applicable) may begin when the concrete is found to have the required compressive strength, provided in no case shall supports be removed in less than seven (7) days after placing the concrete.
- All forms shall be removed, except when no permanent access is available to the cells, the forms supporting the deck of box girders and the forms in hollow abutments or piers may remain in place. Prior to completion of forming for the deck forms, the inside of box girders shall be cleared of all loose material and swept clean.

- Methods of form removal likely to cause overstressing of the concrete shall not be used. In general, the forms shall be removed from the bottom upwards. Forms and their supports shall not be removed without approval. Supports shall be removed in such a manner as to permit the concrete to uniformly and gradually take the stresses due to its own weight.
- In general, arch centering or falsework / formwork shall be struck and the arch made self-supporting before the railing or coping is placed. This precaution is essential in order to avoid jamming of the expansion joints and variations in alignment. For filled spandrel arches, such portions of the spandrel walls shall be left for construction subsequent to the striking of centers, as may be necessary to avoid jamming of the expansion joints.
- Centers shall be gradually and uniformly lowered in such a manner as to avoid injurious stresses in any part of the structure. In arch structures of two or more spans, the sequence of striking centers shall be approved by the Engineer.

16.6.5.4 Measurement and Payment

For all concrete structures, prestressed concrete structures or portions thereof, no separate Measurement or payment shall be made of false-work-supporting such structures. All false-work costs shall be considered as included in the contract prices paid (post/CM or LM of structural members or lump-sum) for the various items of concrete work and no additional compensation would be allowed thereof.

16.6.6 Steel Reinforcement

16.6.6.1 Description

This work shall consist of furnishing, fabricating and placing of steel reinforcement of the type, size, shape and grade required in accordance with these Specifications and in conformity with the requirements shown on the Drawings and Special Provisions or as directed by the Engineer.

16.6.6.2 Material Requirement

All materials shall conform to the requirements hereinafter given. Test reports from approved sources shall be submitted to the Engineer for all steel reinforcement used. These reports shall show the results of chemical and physical tests made i.e.

- Deformed Billet Steel Bars (Grades 40 and 60) for Concrete Reinforcement-AASHTO M 31 (ASTM A 615)
- Deformed Steel Wire for Concrete Reinforcement-AASHTO M 225 (ASTM A 496)
- Welded Steel Wire Fabric for Concrete Reinforcement-AASHTO M 55 (ASTM A 185)
- Steel Bar Mats for Concrete Reinforcement-AASHTO M 54 (ASTM A 184)
- Cold-Drawn Steel Wire for Concrete Reinforcement-AASHTO M 32 (ASTM A 82)
- Welded Deformed Steel Wire Fabric for Concrete Reinforcement-AASHTO M 221 (ASTM A 497)
- Structural Shapes for Concrete Reinforcement ASTM A 36
- The plain rounds smaller than 9.5mm (3/8") in diameter (steel wires) ASTM A510.

16.6.6.3 Tensile Strength, Yield Strength and Elongation Requirement

The tensile properties of round bars of grade 40 and 60 shall satisfy the requirements as shown in following Table.

	Grade-40	Grade-60
Tensile strength, min. MPa (psi)	500 (70,000)	620 (90,000)
Yield strength, min. MPa (psi)	300 (40,000)	420 (60,000)

Table 62, Tensile Requirements Grade- 40

The percentage of Elongation in 200mm (8inch) shall be as shown in the Table below: -

Bar Designation No. (Diameter in mm)	Grade-40	Grade-60
3 (10)	11mm	9mm
4,5,6 (13,16,19)	12mm	9mm
7,8 (22,25)	-	8mm
9,10,11,14,18 (29,32,36,43,57)	-	7mm
Grade 40 bars are furnished only in sizes 3 through 6 (10 through 19)		

Table 63, Elongation Requirements

16.6.6.4 Yield Point

The yield point of mild steel of 40 Grade and 60 Grade will be 276 MPa (18 tons/square inch) and 414 MPa (27 ton/square inch) for the bar sizes as shown in Table elongation requirement.

16.6.6.5 Cold Bend Tests

For bend tests, except in the case of round bars 25mm (1 inch) in diameter and under, the test piece when cold shall stand, from hammer until the internal radius is not greater than 1-1/2 times the thickness of the test piece and the sides are parallel. In the cases of round bars 25mm (1 inch) in diameter and under, the internal radius of bend shall not be greater than the diameter of the bar. Bend test requirement are shown in Table below.

Bar Designation No. (Diameter in mm)	Pin Diameter for Bend Test	
	Grade-40	Grade-60
3,4,5 (10,13,16)	3.5d	3.5d
6 (19)	5 d	5 d
7,8 (22,25)	-	5 d
9,10,11 (29,32,36)	-	7 d
14,18 (43,57) (90°)	-	9 d

Table 64, Bend Test Requirements

- Test bends 180° unless noted otherwise
- denominal diameter of specimen.

16.6.6.6 Young's Modulus (E)

The value of the E for steels used in structural works shall be of the order of 21 x 10⁴ MPa (30 x 10⁶ Lbs. Per square inch).

16.6.6.7 Unit Weight

The unit weights to be used for measurement of quantities of steel shall be as shown in the following table that is given below.

Bar No. (Bar designation)	Nominal Wt. lb./f (Nominal mass kg/m)	Nominal Dimension			Deformation Requirements, in. (mm)		
		Diameter, in.(mm)	Cross-section area, in. ² (mm ²)	Perimeter, in. (mm)	Max. Average spacing	Min. average height	Max. gap (chord of 12.5 % of nominal perimeter)
3 [10]	0.376 [0.560]	0.375 [9.5]	0.11 [71]	1.178 [29.9]	0.262 [6.7]	0.015 [0.38]	0.143 [3.6]
4 [13]	0.668 [0.994]	0.500 [12.7]	0.20 [129]	1.571 [39.9]	0.350 [8.9]	0.020 [0.51]	0.191 [4.9]
5 [16]	1.043 [1552]	0.625 [15.9]	0.31 [199]	1.963 [49.9]	0.437 [111]	0.028 [0.71]	0.239 [6.1]
6 [19]	1.502 [2.235]	0.750 [19.1]	0.44 [284]	2.356 [59.8]	0.525 [13.3]	0.038 [0.97]	0.286 [7.3]
7 [22]	2.044 [3.042]	0.875 [22.2]	0.60 [387]	2.749 [69.8]	0.612 [15.5]	0.044 [1.12]	0.334 [8.5]
8 [25]	2.670 [3.973]	1.000 [25.4]	0.79 [510]	3.142 [79.8]	0.700 [17.8]	0.050 [1.27]	0.383 [9.7]
9 [29]	3.400 (5.0601)	1.128 [28.7]	1.00 [645]	3.544 [90.0]	0.790 [20.1]	0.056 [1.42]	0.431 [10.9]
10 [32]	4.303 (6.404)	1.270 [32.3]	1.27 [819]	3.990 [101.3]	0.889 [22.6]	0.064 [1.63]	0.487 [12.4]
11 [36]	5.313 [7.907]	1.410 [35.8]	1.56 [1006]	4.430 [112.5]	0.987 [25.1]	0.071 [1.80]	0.540 [13.7]
14 [43]	7.65 [11.38]	1.693 [43.0]	2.25 [1452]	5.32 [135.1]	1.185 [30.1]	0.085 [2.16]	0.648 [16.5]
18 [57]	13.60 [20.24]	2.257 [57.3]	4.00 [25811]	7.09 [180.11]	1.58 [40.1]	0.102 [2.59]	0.864 [21.9]

Table 65, Nominal Dimensions and Deformation Requirements

16.6.6.8 Construction Requirements

16.6.6.8.1 Fabrication of Bent Bars

1. Order Lists

Before materials are ordered all order, lists and bending diagrams shall be furnished by the Contractor, for the approval of the Engineer. The approval of order lists and bending diagrams by the Engineer shall in no way relieve the Contractor of responsibility for the correctness of such lists and diagrams. Any expenses incident to the revisions of material furnished in accordance with such lists and diagrams to make it comply with the Drawings shall be borne by the Contractor. Project shop drawings for bar lists and bending diagrams will be provided to the Engineer for approval, according to AASHTO-SS Section II-9.3. These documents shall be given to the Engineer at least one month before placing the steel. All grade sixty (60) bars shall be brought to the Site in straight bars.

2. Storing and Surface Condition of Reinforcement

Steel reinforcement shall be stored above the surface of the ground on platforms, skids, or other supports and shall be protected as far as practicable from mechanical injury and surface deterioration caused by exposure to conditions producing rust. When placed in the work, reinforcement shall be free from dirt, detrimental rust, loose seals, paint, grease, oil, or other

foreign materials. Reinforcement shall be free from injurious defects such as cracks and laminations. Surface seams, surface irregularities or mill scale will not be cause for rejection, provided the minimum dimensions, cross-section area and tensile properties of a hand-wire brushed specimen meet the physical requirements for the size and grade of steel specified.

3. Fabrication

Bent bar reinforcement shall be cold bent to the shapes shown on the Drawings or required by the Engineer. Bars shall be bent around a pin having the following diameters(D) in relation to the diameter of the bar (d): -

- Stirrups & column tie bars D = 4 x d
- Other bars having: -

d < 3.5 cm (1 3/8", No. 11 bar): -

- Grade 40 D = 5 x d
- Grade 60 D = 8 x d

d > 3.5 cm (1 3/8", No. 11 bar) D = 10 x d

For deformed bars grade 60, bending will be made only mechanically.

16.6.6.8.2 Placing and Fastening

1. Protection of Material

Steel reinforcement shall be protected at all times from injury. When steel, placed in position as shown on the Drawings, has easily removable and detrimental rust, loose scale, or dust, it shall be cleaned by a satisfactory method, approved by the Engineer.

2. Placing and Fastening

Reinforcing steel shall be accurately placed in the position shown on the Drawings and firmly held during the depositing and finishing of the concrete. Cover, the distance between the external face of the bar and the face of the finished concrete, shall be as indicated on the Drawings. Reinforcing steel bars embedded in concrete shall not be bent after they are in place. Bars shall be tied at all intersections with 16-gauge black annealed wire except that where spacing is less than 1 ft (0.3 m) in each direction, alternate intersections need to be tied. All intersections shall be tied in the top mat of reinforcement placed on bridge decks and the top slabs of box culverts. Abrupt bends shall be avoided except where one steel bar is bent around the other.

Stirrups and ties shall always pass around the outside of main bars and be securely attached thereto. All reinforcing steel shall be securely held at the proper distance from steel forms, which remain in place by means of galvanized steel bars or chairs placed on the forms. All reinforcing steel, except as mentioned above, shall be securely held at the proper distance from the forms by means of templates, concrete blocks or galvanized steel chairs. Metal chairs shall not be used against formed surfaces, which will be exposed in the finished structure after the forms are stripped. Blocks for holding reinforcement away from contact with the forms shall be precast concrete blocks of approved shape and dimensions and shall have sixteen (16) gauge black annealed tie wires embedded in them. The precast concrete block shall have a compressive strength equal to that specified for the class of concrete to be placed in the work. Layers of bars shall be separated by m.s. bars of 1" (25 mm dia spares).

Any broken or damaged concrete spacer blocks shall be removed before concrete is placed. The use of pebbles, pieces of broken stone or brick, metal pipe or wooden blocks as spacers will not be permitted. Reinforcing steel when placed in the work shall be free from flake rust, dirt and foreign material and before any concrete is placed, any mortar that may be adhering to the reinforcing steel shall be removed. No concrete shall be deposited until the Engineer has inspected the placing of the reinforcing steel and given permission to place the concrete. The Contractor shall inform the Engineer well in advance after the reinforcement and forms are in place to conduct the inspection. Any bar of incorrect size, length or shape shall be removed and replaced with correct bars. Any bar located or spaced incorrectly shall be relocated or spaced correctly before permission is given to place concrete and such replacements and corrections shall be at the Contractor's expense. All concrete placed in violation of these provisions shall be rejected and removed.

3. Tolerances

Tolerances on bars placing will be plus twenty (+20) mm in any direction parallel to a concrete face and plus ten (+10) mm at right angle to a face.

4. Control of Formwork before Placing the Steel

No reinforcement shall be placed before the Engineer has inspected the formwork and given his approval. The Contractor shall allow the Engineer at least four (4) working hours after the form is finished to conduct the inspection.

5. Splicing

All reinforcement shall be furnished in the full lengths indicated on the Drawings unless otherwise permitted. Splicing of bars, except where shown on the Drawings, will not be permitted without the written approval of the Engineer. Splices shall be staggered as far as possible and with a minimum separation of not less than forty (40) times bar diameters. Not more than one third (1/3) of the bars may be spliced in the same cross-section, except where shown on the Drawings. The Contractor may require the use of mechanical couplers splices. This requirement will have to be met according to AASHTO-SS-9.7.4. Unless otherwise shown on the Drawings, bars shall be lapped with a minimum overlap of forty (40) times the bar diameter. In lapped splices, the bars shall be placed in contact and wired together. Lapped splices will not be permitted at locations where the concrete section is insufficient to provide a minimum clear distance of one bar diameter or one and one third the maximum size of coarse aggregate between the splice and the nearest adjacent bar. Welding of reinforcing steel shall be done only if detailed on the Drawings or if authorized by the Engineer in writing. Spiral reinforcement shall be spliced by lapping at least one and one half (1 1/2) turns or by butt welding unless otherwise shown on the Drawings.

6. Lapping of Bar-Mat

Sheet of mesh or bar-mat reinforcement shall overlap each other sufficiently to maintain a uniform strength and shall be securely fastened at the ends and edges. The overlap shall not be less than one mesh in width.

7. Covering

The minimum covering, measured from the surface of the concrete to the face of any reinforcement bar shall, unless otherwise shown on the Drawings or directed by the Engineer, be not less than five (5) cm except as follows: -

- Top of slab 4.0 cm

- Bottom of slab 3.0 cm
- Stirrups and ties in T-beams 3.5 cm

In the footings of abutments and retaining walls the minimum covering shall be 2" (5cm). In work exposed to the action of sea water the minimum covering shall be ten (10) cm / 4".

16.6.6.9 Measurement and Payment

16.6.6.9.1 Measurement

The quantity to be paid for shall be the calculated theoretical number of metric tons of reinforcement steel bars, mesh or mats as determined from the approved bar bending diagrams and incorporated in the concrete and accepted, except when reinforcement is paid for under other pay items. The weight of plain or deformed bars or bar mat would be computed from the theoretical weight of plain round bars of the same nominal size as shown in the following tabulation: -

Size (mm)	Weight in Kilograms (Per Meter)
6	0.222
8	0.395
10	0.616
12	0.888
13	1.042
16	1.578
20	2.466
22	2.984
25	3.853
32	6.313
35	7.553
40	9.865

Table 66, Bar Sizes and their Weight

- Clips, ties separators, and other material used for positioning and fastening the reinforcement in place and structural steel shall not be included in the weight calculated for payment under this item. If bars are substituted upon the Contractor's request and as a result more steel is used than specified, only the amount specified shall be measured for payment.
- When laps are made for splices, other than those shown on the Drawings or required by the Engineer and for convenience of the Contractor, the extra steel shall not be measured nor paid for.
- When continuous bars are shown on the Drawings, without the splices being shown the necessary steel in the splices would be paid for on the basis of the individual bars not being shorter than twelve meters.
- For bent bars, the length along center-line of bar would be paid.

16.6.6.9.2 Payment

The accepted quantities measured as provided above shall be paid for at the Contract unit price as entered in the contract agreement and includes procurement straightening, cutting bending, wastage, hoisting, binding wire, chairs, spacers, labour chares and T&P etc.

Pay Item No.	Description	Unit of Measurement
16.6.6.9.2.1	Deformed Mild Steel Reinforcement as per (AASHTO M31 Grade 40)	M.Ton
16.6.6.9.2.2	Deformed Mild Steel Reinforcement as per (AASHTO M31 Grade 60)	M.Ton
16.6.6.9.2.3	Deformed Steel Wire for Reinforcement of Concrete as per (AASHTO 225 M)	M.Ton
16.6.6.9.2.4	Welded Plain Steel Wire Fabric for Concrete Reinforcement as per (AASHTO M 55)	M.Ton
16.6.6.9.2.5	Steel Bar Mats for Concrete Reinforcement as per (AASHTO M 54)	M.Ton
16.6.6.9.2.6	Cold Drawer Steel Wire for Concrete Reinforcement as per (AASHTO M 32)	M.Ton
16.6.6.9.2.7	Welded Deformed Steel Wire Fabric for Concrete Reinforcement as per (AASHTO M 221)	M.Ton
16.6.6.9.2.8	Reinforcement (Structures Shapes) as per (ASTM A-36 221)	M.Ton

16.6.7 Prestressed Concrete Structures

16.6.7.1 Description

This work shall consist of pre-stressing precast or cast-in-place concrete by furnishing, placing and tensioning of pre-stressing steel in accordance with details shown on the plans and as specified in these Specifications or as directed by the Engineer. This work shall also include the furnishing and installation of any appurtenant work necessary for the particular pre-stressing system to be used, including but not limited to ducts, anchorage assemblies and grout used for pressure grouting ducts.

16.6.7.2 Material Requirements

16.6.7.2.1 Pre-stressing Reinforcement Steel

Prestressing steel shall be high-tensile wire conforming to ASTM Specification A 421 or AASHTO M 204; strand or rope conforming to ASTM Specification A 416 or AASHTO M 203 or high tensile alloy bars as follows: -

High-tensile-strength alloy bars shall be stress relieved and cold stretched to a minimum of nine thousand one hundred (129,433 Psi) kg/sq. cm. After cold stretching, the physical properties shall be as follows: -

- Minimum Ultimate tensile strength 16,570 kg/sq. cm (235,681 Psi)
- Minimum yield strength, measured by the 0.7 percent extension under load method shall be not less than 9100 kg/sq. cm (129,433 Psi)
- Minimum modulus of elasticity 1.75 x 10⁶ kg/sq. cm
- Minimum elongation in 20 bar dia meter 4 percent
- Diameters after rupture - 0.75 mm

- Diameters tolerance - 0.25 mm

The steel shall be free from injurious defects and shall have a smooth surface. Material, which shows injurious defects during or prior to its installation in the work, shall be rejected. Wire and strand shall be supplied in coils of sufficient diameter to ensure that they lie out straight. The Engineer may call for a relaxation test on prestressing steel, in case, he is not satisfied with the source of manufacture. Relaxation for prestressing steel shall be measured over a period of thousand (1,000) hours stressed at seventy (70) % of its ultimate tensile strength giving less than six (6) % elongation.

16.6.7.2.2 Testing

All wires, strands, or bars to be shipped to the Site shall be assigned a lot number and tagged for identification purposes. Anchorage assemblies to be shipped shall be likewise identified. All samples submitted shall be representative of the lot to be furnished. All of the materials specified for testing shall be furnished free of cost and shall be delivered in time for tests to be made well in advance of anticipated time of use. The selection of samples shall be made at the manufacturer's plant by the Engineer or his representative. The Contractor shall furnish for testing the following samples selected from each lot as ordered by the Engineer.

1. Pre-tensioning Method

Samples at least 2.10 M long shall be furnished of each wire or strand size. A sample shall be taken from each and every coil.

2. Post-Tensioning Method

- Samples of the following lengths shall be furnished: For wires, sufficient length to make up one parallel-lay cable one and a half (1½) m long consisting of the same number of wires as the cable to be furnished. For strands, one and a half (1½) m length shall be furnished.
- For bars to be furnished with threaded ends and nuts, one and a half (1½) m between threads at ends.

3. Anchorage Assemblies

Two anchorage assemblies of each size of anchorage to be used shall be furnished, complete with distribution plates.

16.6.7.2.3 Concrete

The materials for concrete shall conform to the requirements given in chapter 6 'Concrete'. The concrete shall be Class D as shown in earlier Table unless otherwise shown on the plans.

16.6.7.2.4 Reinforcement Steel

Reinforcement steel shall conform to the requirements of chapter-6 'Concrete'.

16.6.7.3 Construction Requirement

16.6.7.3.1 General

- Unless otherwise ordered by the Engineer, the Contractor shall certify for the Engineer's approval that a technician skilled in the approved prestressing or post tensioning method will be available to the Contractor to give aid and instruction in the use of the prestressing equipment to obtain the required results. The contractor will use either Freyssinet System or strong hold system of pre-stressing post tensioning and will get approval of the particular system from the Engineer before start of work.
- The tensioning process shall be conducted so that the tension being supplied and the elongation may be measured at all times.
- During the prestressing operations, standing behind or under jack will not be allowed in order to ensure that no one is injured by the flying spindle, tendon or the jack in the event of a break occurring.

16.6.7.3.2 Pre-stressing Method

The method of prestressing to be used shall be optional with the Contractor, provided he introduces no change in the position of centroid of the total prestressing force over the length of the member and in the magnitude of the final effective prestressing force as prescribed in the Drawings. The prestressing system chosen by the Contractor shall have been indicated in the tender. This option shall be subject to all requirements hereinafter specified. Independently from the prestressing system to be applied, the following points have to be ensured: -

- The safety of the anchorage of the prestressing tendons and their suitability for the transmission of forces to the concrete under all loads whatsoever.
- That the actual losses due to friction coincide with the calculated ones for the prestressing.
- The suitability of the proposed steel for the chosen prestressing system.
- The length of transmission of the force to the concrete and the minimum strength of the latter necessary for prestressing in systems, where the prestressing elements are fully or partially anchored to the concrete through bond and friction.
- The suitability of measures taken to protect prestressing tendons from corrosion until the final tensioning is carried out.

The Contractor shall submit well in advance to the Engineer for approval complete details of the methods, materials and equipment he proposes to use in the prestressing operations. Such detail shall outline the method and sequence of stressing, complete specifications and details of the prestressing steel and anchoring devices proposed for use, anchoring stresses, type of enclosures and all other data pertaining to the prestressing operation, including the proposed arrangement of the prestressing units in the members. An agreement certificate for the prestressing system shall be submitted and approved by the Engineer before any structural member to be prestressed may be tensioned; this agreement certificate must be issued by an authorized testing laboratory otherwise the Engineer may order such an agreement certificate from a laboratory of his choice at the cost of the Contractor. All rules referring to this agreement certificate here in after are subject to the approval of the Engineer.

16.6.7.3.3 Pre-stressing Equipment

Hydraulic jacks shall be equipped with accurate pressure gauges. The Contractor may elect to substitute screw jacks or other types for hydraulic jacks. In that case, proving rings or other approved devices shall be used in connection with the jacks. All devices, whether hydraulic jack gauges or otherwise, shall be calibrated so as to permit the stress in the prestressing steel to be computed at all times. A certified calibration curve shall accompany each device. Safety measures shall be taken by the Contractor to prevent accidents due to possible breaking of the prestressing steel or the slipping of the grips during the prestressing process.

All equipment's shall be thoroughly washed with clean water at least once every three (3) hours during the grouting operations and at the end of use for each day.

16.6.7.3.4 Enclosures

- Enclosures for prestressing steel shall be accurately placed at locations shown on the plans or approved by the Engineer.
- All enclosures shall be of ferrous metallic material and shall be completely mortar-tight with the exception that the Contractor, at his option, with the approval of the Engineer, may form the enclosures by means of cores or ducts composed of rubber or other suitable material that can be removed prior to installing the prestressing reinforcement. Enclosures shall be strong enough to maintain their shape under such forces as will be imposed upon them. They shall be six (6) mm larger in internal diameter than the bar, cable, strand or group of wires, which they enclose. Where pressure grouting is specified, cores or ducts shall be provided with the pipes or other suitable connection for the injection of grout after the prestressing operations have been completed.

16.6.7.3.5 Placing Steel

All steel units shall be accurately placed in the position shown on the Drawings or required by the Engineer and firmly held during the placing and setting of the concrete. Distance from the forms shall be maintained by stays, blocks, ties, or hangers approved by the Engineer. Blocks for holding units from contact with the forms shall be precast mortar blocks of approved shape and dimensions. Layers of units shall be separated by mortar blocks or other equally suitable devices. Wooden blocks shall not be left in the concrete. Suitable horizontal and vertical spacers shall be provided, if required, to hold the wires in place in true position in the enclosure.

16.6.7.3.6 Placing Concrete

Concrete shall be controlled, mixed and handled as specified in other articles of this section unless otherwise specified herein. Concrete shall not be poured in the forms until the Engineer has inspected the placing of the reinforcement, conduits, anchorages and prestressing steel and has given his approval thereof. The concrete shall be vibrated internally or externally, or both, as ordered by the Engineer. The vibrating shall be done with care in such a manner as to avoid displacement of reinforcement, conduits or wires.

16.6.7.3.7 Pre-tensioning

The pre-tensioning elements shall be accurately held in position and stressed by jacks. A record shall be kept of the jacking force and the elongation produced thereby. Several units may be cast in one continuous line and stressed at one time. Sufficient space shall be left between ends of units, if necessary, to permit access for cutting after the concrete has attained the required strength. No bond stress shall be transferred to the concrete, nor end anchorages released, until the concrete has attained a compressive strength, as shown by cylinder tests, of at least two hundred eighty (280) kg/sq. cm and as approved by the Engineer. The elements shall be cut or released in such an order that lateral eccentricity of prestress will be minimum.

16.6.7.3.8 Post Tensioning

- Tensioning shall be carried out only in the presence of the Engineer or his representative unless permission has been obtained to contrary. Immediately before tensioning, the Contractor shall prove that all tendons are free to move between jacking

points and that members are free to accommodate the horizontal and vertical movements due to the applications of prestress.

- Tensioning of prestressing reinforcement shall not be commenced until tests on concrete cylinders, manufactured of the same concrete and cured under the same conditions, indicate that the concrete of the particular member to be prestressed has attained a compressive strength of at least 280 kg/sq. cm.
- After the concrete has attained the required strength, the prestressing reinforcement shall be stressed by means of jacks to the required tension and stress transferred to the end anchorages. Stressing shall be from both ends unless otherwise required in the Contract or agreed by the Engineer. The tensioning process shall be so conducted that the tension being applied and the elongation of the prestressing elements may be measured at all times. The friction loss in the elements i.e. the difference between the tension at the jack and the minimum tension in the prestressing steel shall be determined by the formula: -

$$F_t = 2(F_1 - a c E)$$

Where: -

- F_t = total friction loss
- F₁ = Observed tension at the jack
- a = cross-sectional area of the prestressing element
- c = observed elongation of the element when the force at the jack is F₁
- E = secant modulus of elasticity of the element for the stress F₁, as determined from the stress-strain diagram of the element.
- d = distance from the jack to the point of lowest tension in the element. Where jacking is done from both ends of the members, the point of minimum tension is the center of the member. Where jacking is done from one end only, d is the distance to the other end of the member

- Any surplus length of tendon shall be cut off by an approved method that will not affect the strength of the stressed tendon, with particular care if the use of spark erosion or oxyacetylene burning methods of cutting are approved by the Engineer.
- A record shall be kept of gauge pressures and elongation at all times and submitted to the Engineer for his approval within twenty-four (24) hours of each tensioning operation. The tendons shall be maintained in such a condition that they can be re-stressed until the Engineer has given final approval after inspecting the tensioning log.

16.6.7.3.9 Grouting of Bonded Steel

- Post-tensioned prestressed bridge members preferably shall be of the bonded type in which the tensioned steel is installed in holes or flexible metal ducts cast in the concrete and bonded to the surrounding concrete by filling the tubes or ducts with grout. The grout shall be a mixture of cement and fine sand (passing a No. 30 sieve) in the approximate proportion of one-part cement to 0.75-part sand, the exact proportions to be adjusted to form a grout having the proper consistency and under no circumstances, shall the water cement ratio exceed 0.45. The compressive strength of the hardened grout shall not be less than one hundred seventy (170) kg/sq. cm after seven (7) days at a temperature of eighteen (18) °C, when making preliminary trials for quality. The grout shall be mixed for a minimum of two (2) minutes and until a uniform consistency is obtained.
- All prestressing reinforcement to be bonded shall be free of dirt, loose rust, grease, or other deleterious substances. Before grouting, the ducts shall be free of water, dirt or any other foreign substance. The ducts shall be blown out with compressed air until

no water comes through the duct. For long members with draped strands an open tap at the low point of the duct may be necessary.

- The grout shall be fluid (consistency of thick paint) but proportioned so that free water will not separate out of the mix. Unpolished aluminum powder may be added in an amount per sack of cement as approved by the Engineer. Commercial plasticizer used in accordance with the manufacturer's recommendation may be used provided they contain no ingredients that are corrosive to steel. Sufficient pressure shall be used in grouting to force the grout completely through the duct, care being taken that rupturing of the ducts does not occur.

16.6.7.3.10 Handling

- Precast prestressed concrete members shall be transported in an upright position and the points of support with respect to the member shall be approximately the same during transportation and storage as when the member is in its final position. In the event that the Contractor deems it expedient to transport or store precast girders in other than this position it should be done at his own risk.
- Care shall be taken during storage, hoisting and handling of the pre-casting units to prevent cracking or damage. Units damaged by improper storing or handling shall be replaced by the Contractor at his expense.
- Prestressed structural members shall be constructed in conformity with the drawings governing the particular type of structure to be built or as required by the Engineer.

16.6.7.3.11 Manufacturing of Prestressed Members off the site

- The details of the method of manufacture shall be approved by the Engineer before work is started. When the method has been approved, no changes shall be made without the consent of the Engineer.
- The Contractor shall inform the Engineer in advance of the date of commencement of manufacture and the dates when tensioning of tendons, casting of members and transfer of stress will be undertaken for the first time for each type of beam.
- The Contractor shall send to the Engineer not more than seven (7) days after the transfer of stress, a certificate showing the force and strain in the tendons immediately after they were anchored, the strength and age of the test cubes cast in accordance with specified procedure and the minimum age in hours of the concrete at the time the stress was applied to the member. A copy of all twenty-eight (28) days' cube test results relating to the work shall be sent to the Engineer as these become available. Records shall be kept so that the identity of those who stress the tendons, cast the concrete and transfer the stress on any member or line of members can be traced.
- Where the Engineer's Representative requires tests to be carried out, no beams to which the tests relate shall be dispatched to the Site until the tests have been satisfactorily completed.

16.6.7.3.12 Composite Slab Bridge

The manufacturing tolerances for the precast members shall no-where exceed those given for the length, cross-section and straightness in BS Code of Practice CP116(1969). The structural use of precast concrete. In addition, where beams are laid side by side in a deck: -

- The difference in soffit level between adjacent units before the in-situ concrete is placed shall no-where exceed five (5) mm for units up to five (5) meters nor ten (10) mm for longer units.

- The width of the deck soffit shall be within plus twenty-five (+25) mm of that described in the Contract.
- In adjacent spans, the continuity of line of the outside beams shall be maintained.
- The width of the gap between individual beams shall not exceed twice the nominal gap described in the contract.
- The alignment of transverse holes shall permit the reinforcement or prestressing tendons to be placed without distortion.

The in-situ concrete shall be placed in such a sequence that the advancing edge of the freshly deposited concrete over the full width of deck or between longitudinal construction joints is approximately parallel to the deck supports. Beams shall be prevented from moving laterally during the placing of the in-situ concrete.

16.6.7.3.13 Sampling and Testing

1. Testing of Pretensioned Beams

- Any beam required by the Engineer to be subjected to a load test will be selected after transfer and wherever possible before the beam has been removed from the casting yard to the storage area. The Contractor shall not proceed with a load test until he has obtained the approval of the Engineer to the detailed arrangements. Except where otherwise agreed by the Engineer, the load test shall be carried out not less than twenty-eight (28) days after casting. The cost of the load test shall be born by the Contractor.
- The beam shall be supported at its design points of bearing. The specified test loads shall be applied equally at the third points of the span in not less than ten (10) approximately equal stages. The maximum load shall be sustained for five (5) minutes and then removed, in not less than five (5) approximately equal stages. The mid-span deflection relative to a straight reference line joining the points of support shall be measured for each value of the load and five (5) minutes after removal of the load.
- Loads shall be measured with an accuracy of plus two (+2) % or fifty (50) kg and deflections with an accuracy of plus one-half (+1/2) mm.
- The load-deflection graph shall be plotted from these values and shall show no appreciable variation from a straight line. If after five (5) minutes of removal of the load, the beam does not show a recovery of at least ninety (90) % of the maximum deflection recorded during the test, the test loading shall be repeated. The beam shall be considered to have failed the test, if the recovery five (5) minutes after removal of the test load for the second time is not at least ninety (90) % of the maximum deflection recorded during the second test.
- The result of the test shall be deemed to apply to the other beams cast in the same production line but in the event of failure any additional beam may be separately tested at the Contractor's option.
- The Contractor shall supply to the Engineer record sheets of the test showing the age of the beam at the time of the test, loads, deflections, load-deflection curves and calculated value of Young's Modulus of Elasticity (E).
- In addition, the record sheets supplied by the Contractor to the Engineer shall show the temperatures of the top and bottom surfaces of the beam measured at the time of the test.

2. Testing of Prestressing Anchorages

Anchorage for post-tensioning shall be tested in accordance with the procedure described in BS4447 or as approved by the Engineer. For each anchorage system used in the Works, the characteristic value for anchorage efficiency shall be not less than ninety (90) %.

16.6.7.3.14 Curing Concrete

1. General

For all prestressed concrete operations, the curing procedures shall be well established and properly controlled. Curing shall be commenced immediately following initial set or completion of surface finishing. Members shall be kept wet during the entire period of curing.

2. Method of Curing

The curing methods shall conform to those detailed under chapter-6 'Concrete' of Book-2.

16.6.7.4 Measurement and Payment

16.6.7.4.1 Measurement

Measurement and payments for the various items in prestress concrete work shall be made in accordance with appropriate items of relevant sections, as depicted in the Drawings.

16.6.7.4.2 Payment

1. Precast Prestressed Concrete Member

The quantity to be paid for shall be the number of prestressed concrete structural members of the several types and sizes, constructed and installed in place as per Drawings completed and accepted. Each member shall include the concrete, reinforcement and prestressing steel, enclosures for prestressing steel, anchorage, plates, nuts, formwork, shuttering including its removal and centering if required and other such material contained within or attached to the unit.

2. Cast-in-Place Prestressed Concrete

The work to be paid for under this section will be the concrete of specified class, prestressing work as specified here and shown on the Drawings or required by the Engineer and shall include supply and installation of prestressing high tensile steel, spacers, enclosures, anchorages plates, nuts and other such material deemed necessary to complete the work. Steel reinforcement, concrete, will be measured and paid for accordingly. Pay Item No., Description and Unit of Measurement for Precast Prestressed Concrete Members and Cast-in-Place Prestressed Concrete will be covered, under specified BOQ item number provided in Special Provisions, as per Drawings and other related documents for following items separately: -

Pay Item No.	Description	Unit of Measurement
16.6.7.4.2.1	Reinforced Prestressed cement concrete of specified strength in Beams a Girders of the sizes and dimensions shown in drawings. Concrete Member (including grouting and Formwork)	Cub M or Cub ft.

16.6.7.4.2.2	Reinforced prestressed cement concrete of specified strength in diaphragm of the size and dimensions shown in drawings. Prestressed ropes / strands, size	Cub M or Cub ft.
16.6.7.4.2.3	Reinforced prestressed cement concrete slab of specified thickness and dimensions shown in drawing.	Cub M or Cub ft.
16.6.7.4.2.4	Lifting, transporting and placing beams, diaphragms, slabs. Prestressed Hardware Including Sheets etc.	Cub M or Cub ft.
16-89-a	Prestressed High Tensile Metallic ropes strand of specified quality including prestressing etc.	M. Ton
16-89-b, c	Prestressed High tensile Metallic Wires of specified quality including prestressing etc.	M. Ton
16.6.7.4.2.7	Prestressing arrangement including Hardware sheets, male female come and Anchorage arrangement required under Freysinot or Stronghold pre-stressing or post tensioning system	M. Ton
16.6.7.4.2.8	Furnishing and placing plain reinforcing steel bars of identified Grade _____	M. Ton
16.6.7.4.2.9	Furnishing and placing plain reinforcing steel bars of identified Grade _____	M. Ton

16.6.8 Joints and Bearing Devices for Concrete Structures

16.6.8.1 Description

The work covered in this item shall consist of furnishing all plant, equipment; materials and labor in performing all operations in connection with furnishing and placing (in concrete structures) all deck expansion joints and seals, metal beefing pads and elastomeric bearing pads complete and in accordance with the Specifications, the Drawings, and/or as required by the Engineer.

16.6.8.2 Material Requirement

16.6.8.2.1 Concrete Joint Filler

1. Pre-molded Expansion Joint Fillers

a). Non-Extruding and resilient type

Unless otherwise directed by the Engineer preformed joints filler shall conform to the requirements of AASHTO M 153 (ASTM D 1752)

b). Bituminous fiber type

Unless otherwise directed by the Engineer preformed joints filler shall conform to the requirements of AASHTO M 213 (ASTM D 1751)

c). Preformed Elastomeric Compression Joint Seal

Unless otherwise directed by the Engineer preformed joints filler shall conform to the requirements of AASHTO M 220.

d). Neoprene Rubber Sheet with Bitumastic Seal

Unless otherwise directed by the Engineer, neoprene rubber sheets six (6) mm in thickness, meeting the requirements of Item, shall be used as joint filler covered with a bitumastic seal as shown on the Drawing.

16.6.8.2.2 Steel for Deck Expansion Joint Seals

Plates, angles or other structural shapes including anchor bolts required for the expansion joint seals shall conform, to the requirements of AASHTO M-160 and shall be hot zinc sprayed (galvanized) with the exception to the nuts and washers which shall in stainless steel.

16.6.8.2.3 Elastomer for Deck Expansion Joint Seals

Elastomer shall be of a component as neoprene or of polyvinyl chloride (PVC); at the option of the Contractor. Neoprene shall be manufactured from a vulcanized elastomeric compound containing neoprene as the sole Elastomer and shall have the following physical characteristics in accordance with ASTM Method D15, Part B.

Hardness, Durometer A (ASTM D 2240)	45 + 5 points
Tensile Strength (ASTM D 412)	127 kg/sq cm min
Elongation at Break	400 % min
Compression Set, 22 Hours at 70 °C (ASTM D 395, Method B)	20 % max
Low Temperature (ASTM D 746)	Not brittle at 40 °C
Ozone Resistance, Exposure to 100 PPHM Ozone for 70 hours at 38 °C. Sample under 20 % (ASTM D 1149)	No cracks
Oil Deterioration - Volume increase after soaking in ASTM oil No. 3 for 70 hours at 100 °C (ASTM D 470)	120 % max

Table 67, Physical Characteristics of Elastomer for Joint Seals

16.6.8.2.4 Metal Bearing Devices

Unless otherwise directed by the Engineer or provided in the, Special Provisions, the requirements for metal bearings shall conform to the following: -

- AASHTO M 107 for bronze bearing
- AASHTO M 108 for rolled copper alloy bearings
- ASTM B 438 sintered metal powder bearings.
- AASHTO M 160 for galvanized steel bearings.

16.6.8.2.5 Elastomeric Bearing Pads

- Elastomeric bearings as herein specified shall include plain bearings (consisting of elastomer only) and laminated bearings (consisting of layers of elastomer restrained at their interfaces by bonded laminates).
- The reinforcing steel plate laminations for bearing pads shall conform to the requirements of AASHTO M 183.

- Elastomeric bearing pads shall conform to the requirements in these Specifications and the Special Provisions.
- Pads twelve (12) mm and less in thickness may be either laminated or all elastomer.
- Pads over twelve (12) mm in thickness shall be laminated.
- Laminated pads shall consist of alternate laminations of elastomer and metal or elastomer and fabric bonded together.
- The thickness called for an elastomeric bearing pad is deemed to be the total effective thickness of the elastomeric laminations.
- The outside laminations shall be metal or fabric. The outside edges of metal laminations shall be coated over with elastomer not more than three (3) mm in thickness.
- The edges of the steel reinforcing plates of the bearing pads shall be carefully treated to prevent notch effects.
- Steel plates shall be fully enclosed in elastomer so that there is no danger of corrosion.
- Laminations of elastomer shall be twelve plus or minus three (12±3 mm) thickness. Variation in thickness of an individual elastomer lamination shall not exceed three (3) mm within the width or length of a pad and the variation in thickness of all elastomer laminations within a pad shall be such that each metal or fabric lamination will not vary by more than three (3) mm from a plane parallel to the top or bottom surface of the pad.
- The total overall thickness of a pad shall not be less than the thickness shown on the plan nor more than six (6) mm greater than that thickness. Variation of total thickness within an individual pad shall not exceed three (3) mm.
- The length and width of a pad shall not vary more than three (3) mm from the dimensions shown on the Drawings.
- Where elastomeric bearing pads over twelve (12) mm, in thickness are shown on the Drawings or required by the Engineer, such pads may be manufactured as a molded laminated pad, or at the option of the Contractor, may be made up by stacking individual laminated pads.
- When laminated pads are stacked, their contact surfaces shall be cleaned prior to stacking and an approved method shall be used to hold the individual pads in the stack in proper alignment. Pads of all elastomer or with fabric laminations may be cut from large sheets. Cutting shall be performed in such a manner as to avoid heating of the material and to produce a smooth edge with no tears or other jagged areas and to cause as little damage to the material as possible.
- Corners and edges of molded pads may be rounded at the option of the Contractor. Radius at corners shall not exceed ten (10) mm and radius of edges shall not exceed three (3) mm.
- The bond between elastomer and metal or fabric shall be such that, when a sample is tested for separation, failure shall occur within the elastomer and not between the elastomer and metal or fabric. Metal laminations shall be rolled mild steel sheets not less than twenty (20) gauge in thickness.
- Fabric laminations shall be either, (1) a long chain synthetic polymer containing at least eighty-five (85) % of polyester from ethylene glycol and terephthalic acid or (2) a long chain synthetic polymeric amid from hexamethylene diamine and adipic acid. Each ply of fabric shall have a breaking strength of not less than one hundred twenty-five (125) kg/cm of width in both directions. Fabric laminations shall be single ply at top and bottom surfaces of the pad and either double ply or double strength within the pad.
- The sole polymer in the elastomeric compound shall be neoprene and shall be not less than sixty (60) % by volume of the total compound.
- The elastomer, as determined from test specimens, shall conform to the requirements as shown in Table below.

Test	ASTM Designation	Requirements
------	------------------	--------------

Tensile strength, kg/sq. cm	D 412	160 min
Elongation at break, percent	D 412	350 min
Compression set, 22 hours at 67 °C, percent (Method B)	D 395	25 max
Tear Strength, kg/sq. cm	D 624 (Die C)	13 min
Hardness (Shore A)	D 2240	60 + 5 points
Ozone resistance 20% strain, 100 hours at 38 °C + 100 + 20 parts 1 °C	D 1149	(except No Cracks per 100,000,000)
Low temperature stiffness, Young's Modulus at 35 °C, kg/sq cm	D 797	350 max
Low temperature brittleness, 5 hours at - 40 °C	D 736	Passed

Table 68, Requirements for Elastomer

After accelerated aging in accordance with ASTM D 573 for seventy (70) hours at hundred (100) °C, the elastomer shall not show deterioration changes in excess of the following: -

Tensile strength, %	+ 15
Elongation at Break, %	- 50 (but not less than 300% total elongation of the material)
Hardness, points	+ 10
Shear Test (without vertical load)	7 kg/sq. cm (min)

Table 69, ASTM D 573 requirements for Elastomer

- Sampling shall be performed in accordance with AASHTO M 251-74 as appropriate for the tests required during or immediately after manufacture.
- The Contractor shall furnish to the Engineer a certification by the manufacturer that the elastomer and fabric (if used), in the elastomeric bearing pads to be furnished conforms to all of the above requirements. The certification shall be supported by a certified copy of the results of tests performed by the manufacturer upon samples of the elastomer and fabric to be used in the pads.
- The Engineer will take a sample of not less than 15 x 30 cm in size for testing from each lot of pads or batch of elastomer to be furnished, whichever results in the greater number of samples. The samples will be selected at random at the point of manufacture or, at the option of the Contractor at the job-site. Samples taken at the job-site shall consist of complete pads as detailed on the plans and the Contractor shall furnish additional complete pads to replace those taken for testing. Pads shall be available for sampling three (3) weeks in advance of intended use. All sample pads for testing shall be furnished by the Contractor at his expense.

16.6.8.3 Construction Requirements

16.6.8.3.1 Open Joints

Open joints shall be constructed at the locations shown on the Drawings or required by the Engineer using a suitable material which is subsequently removed. When removing the material, care shall be exercised to avoid chipping or breaking of concrete. Reinforcement shall not extend across an open joint, unless shown on the Drawings.

16.6.8.3.2 Filled Joints

When joints of performed type are required on the Drawings or by the Engineer, the filler shall be placed in correct position before concrete is being placed against the filler. Preformed filler with holes and cracks shall not be permitted and shall be rejected.

16.6.8.3.3 Steel Joints

Plates, angles or other structural shapes shall be accurately shaped at the shop to conform to the section of the concrete floor as per drawings. The fabrication shall conform to the requirements in Special Provisions. Care shall be taken to ensure that the surface in the finished plane is true and free of warping. Methods approved by the Engineer shall be employed in placing the joints to keep them in correct position during the placing of the concrete. The opening at expansion joints shall be that to avoid impairment of the clearance in any manner.

16.6.8.3.4 Water Stops (Joint Seals)

- Water stops shall be furnished and installed in accordance with the details shown on the drawings or where required by the Engineer and in accordance with the provisions in these Specifications.
- Water stops shall be furnished in full length for each straight portion of the joint, without filed splices. Manufacturer's shop splice shall be fully vulcanized.
- Reinforcing bars provided to support the water stops shown on the Drawings or as required by the Engineer shall be securely held in position by the use of spacers, supporting wires, or other approved device. Such reinforcing bars shall be considered, for payment purposes, as a part of the water-stop. If, after placing concrete, water-stops are materially out of position or shape, the surrounding concrete shall be removed, the water stop reset, and the concrete replaced, all at the Contractor's expense.
- Field splice for neoprene water-stops shall be either vulcanized or mechanical, using stainless steel parts, or made with a splicing union of the same Stock as the water-stop, at the option of the Contractor. All finished splices shall have a full-size tensile strength of eighteen kg per cm of width.
- Field splices for polyvinyl chloride water-stops shall be performed by heat sealing the adjacent surfaces in accordance with the manufacturer's recommendations, a thermostatically controlled electric source of heat shall be used to make all specified. The heat shall be sufficient to melt but not char the plastic.
- Water stops when being installed shall lie cut and spliced at changes in direction as may be necessary to avoid bucking or distortion of the web or flange.

16.6.8.3.5 Metal Bearing Devices

- Steel bearing plates, bars, rockers, assemblies, and other expansion or fixed devices shall be constructed in accordance with the details shown on the plans and shall be hot-dip galvanized, after fabrication.
- Bronze or copper alloy plates, if specified, shall conform to the requirements of the Special Provisions.
- The bearing plates shall be set level and the rockers or other expansion devices shall be set to conform to the temperature at the time of erection or to the setting specified.
- When bearing assemblies or masonry plates are shown on the Drawings to be placed (not embedded) directly on concrete, the concrete bearing area shall be constructed slightly above grade and shall be finished by grinding or other approved means to a

true level plane which shall not vary perceptibly from a straight edge placed in any direction across the area. The finished plane shall not vary more than three mm from the elevation shown on the drawings or that required by the Engineer.

16.6.8.3.6 Elastomeric Bearing Pads

When elastomeric bearing pads are shown on the Drawing, the concrete surfaces on which pads or packing are to be placed shall be wood, flat finished to a level plane which shall not vary more than one and a half mm. from a straightedge placed in any direction across the area. The finished plane shall not vary more than three mm from the elevation shown on the drawings or that required by the Engineer.

16.6.8.3.7 Asphaltic Felt

The quantity to be paid shall be in square meter of 3 ply rating Fiber/Fabric based asphaltic felt weighing forty-one (41) to forty-five (45) kg per twenty (20) sq. m including striking coat/paint coat and flood coat of special industrial bitumen and sand blinding as approved by the Engineer, laid in place as directed by the Engineer.

16.6.8.4 Measurement and Payments

16.6.8.4.1 Measurement

1. Filled Concrete Joints

The quantity to be paid for shall be in square meters of either expansion joint with preformed joint filler or expansion joint with neoprene rubber sheet six mm thick and covered with Bitumastic seal, completed and accepted Work.

2. Steel Joints

The quantity to be paid for shall be the number of kg of steel for steel joints fabricated, galvanized and placed in the work completed and accepted.

3. Water stops

The quantity to be paid for shall be the number of linear meters of water-stop placed in the work completed and accepted.

4. Bearing device's

The quantity to be paid for shall be the number of cubic cm of bearing devices either steel bearing or elastomeric bearing pads installed in the work completed and accepted.

5. Asphaltic Felt

The quantity to be paid shall be in square meter of 3 ply rating Fiber/Fabric based asphaltic felt weighing forty-one kg to forty five kg per 20 square meters, including striking coat/paint and flood coat of special industrial bitumen and sand blinding as approved by the Engineer, laid in place as directed by the Engineer.

16.6.8.4.2 Payment

The accepted quantities measured as provided above shall be paid for at the Contract unit price respectively for the pay item listed below and shown in the Bill of Quantities, which price and payment shall constitute full compensation for furnishing all materials, labor, equipment, tools and incidentals and any work pertaining to bearings and which is not paid for separately, necessary to complete the item.

Pay Item No.	Description	Unit
16.6.8.4.2	Premoulded Joint filler 12 mm thick with Bitumastic Joint Seal	SM
16-60	Neoprene Rubber joint Filler 12mm thick with Bitumastic joint Seal	SM
16.6.8.4.2	Steel Expansion Joints	Kg
16.6.8.4.2	Water Stops 6" Size	M
16-40-a	Elastomeric Bearing Pads (According to size and thickness)	Cubic Inch
16.6.8.4.2	Asphalt felt (3 Ply)	SM
16-40-b	Steel or metal Bearing Devices	Each

16.6.9 Steel Structures**16.6.9.1 Description****16.6.9.1.1 General**

This work shall consist of steel structures and the steel structure portions of composite structures, constructed in conformity with the lines, grades and dimensions shown on the Drawings or as established by the Engineer. The work will include all labor, materials and equipment required to furnish, fabricate, erect and paint structural metals called for in these Specifications or as shown on the plans. Structural metals will include rivet, welding, special and alloy steels, metallic electrodes, steel forging and castings and iron castings. This work will also include any incidental metal construction not otherwise provided for, all in accordance with these Specifications, Drawings or as directed by the Engineer.

16.6.9.1.2 Drawings

The Contractor shall submit to the Engineer working Drawings for steel structures for approval prior to use in construction. Such working Drawings shall be submitted sufficiently in advance of the start of the related work to allow time for review by the Engineer and correction by the Contractor of the Drawings without delaying the work. Such time shall be proportional to the complexity of the work, but in no case shall such time be less than six (6) weeks. The working Drawings shall show details of any permitted options proposed in the work, details for connections not dimensioned on the plans, the direction of rolling the plates where specific orientation is required, the sequence of shop and field assembly and erection, welding sequences and procedures, the location of all butt welded splices on a layout Drawing of the entire structure, the location of any temporary supports that are to be used and the vertical alignment of the girder at each stage of the erection. Substantiating camber calculations shall be submitted with the working Drawings.

16.6.9.1.3 Inspections

Structural steel will be inspected at the fabrication site. The Contractor shall notify the Engineer when materials have been delivered to the fabrication site and shall give the Engineer at least ten (10) days' notice before commencing the fabrication of any structural steel. The Contractor shall furnish to the Engineer a copy of all mill orders, certified mill test reports and a Certificate of Compliance for all structural steel to be used in the work. Certified mill test reports for steels with specific impact values shall include, in addition to other test results, the results of Charpy V-Notch (CVN) impact tests. When fine grain steel is specified, the test report shall include the grain size. Copies of mill orders shall be furnished at the time, orders are placed with the manufacturer. Certified mill test reports and Certificates of Compliance shall be furnished prior to start of fabrication of material covered by these reports. The Certificates of Compliance shall be signed by the manufacturer and shall certify to the Engineer the specifications to which the material has been manufactured and tested and that the material is in conformance with said specifications and test requirements. Material to be used shall be made available to the Engineer so that each piece can be examined. The Engineer shall have free access at all times to any portion of the fabrication site where said material is stored or where work on said material is being performed.

16.6.9.1.4 Shipping, Handling and Storing

- Members weighing more than two and a half (2 1/2) metric tons shall have the weight marked thereon.
- In handling and shipping of the steel work, every care shall be taken to avoid bending, scraping, or overstressing the pieces. All pieces bent or otherwise injured will be rejected.
- The loading, transporting and unloading of structural material shall be so conducted that the metal will be kept clean. Material to be stored shall be placed above the ground upon platforms, skids, or other supports and shall be kept free from dirt, grease and other foreign material and properly drained and protected from corrosion. Girders and beams shall be placed upright and shored. Long members, such as columns and chords, shall be supported on skids placed near enough together to prevent damage from deflection.

16.6.9.1.5 Falsework

- Falsework used for the erection of structural steel shall conform to the specifications except that dead loads shall consist of the weight of the structural steel and any other portions of the structures which are supported by the falsework.
- Falsework and forms supporting the concrete work on steel structures shall be constructed so that any loads applied to girder webs shall be applied within fifteen (15) cm of a flange or stiffener and shall be distributed in a manner that will not produce local distortion of the web. Temporary struts and ties shall be provided as necessary to resist lateral loads applied to the girder flanges and to prevent appreciable relative vertical movement between the edge of deck form and the adjacent steel girders.
- Loads imposed on existing, new or partially completed structures by the Contractor's construction methods and equipment shall not exceed the load carrying capacity of the structure, or portions thereof, as determined by the Pakistan Code of Practice for Highway Bridges, 1967 or as specified by the Engineer.

16.6.9.1.6 Continuous Members

- Unless otherwise noted on the plans, structural steel girders have been designed for continuity in supporting girder dead load. The Contractor may at his option erect the girders in such a manner that the girder continuity for dead load is or is not as assumed in design. Furnishing and erecting the girders shall be subject to the requirements in this Section.
- If erection procedures are to be used which will provide the designed girder continuity for dead load, members with field joints shall be pre-assembled in a no-load condition in a horizontal or an upright position.
- If erection procedures are to be used which will result in steel girders not attaining the continuity for dead load assumed in design, the Contractor shall furnish to the Engineer for review a statement of steel erection procedures with calculations, in sufficient detail to substantiate that girder capacity and geometry will be corrected.
- If erection procedures are to be used which will result in steel girders not attaining the continuity for dead load assumed in design, the structure shall, after erection, have a load carrying capacity at least equal to the designed structure shown on the plans. The Contractor may increase the cross-sectional area or change the steel grades to provide the specified load carrying capacity subject to approval by the Engineer. Any additional steel or higher strength steels required to accommodate the method of erection selected, shall be considered to be made for the convenience of the Contractor and no additional payment will be made for this steel.

16.6.9.2 Material Requirements

16.6.9.2.1 Description

The various materials shall conform to the specifications of ASTM as listed in the following with certain modifications and additions as specified: -

Material	ASTM Designation
Structural Steel	A 36
High strength low alloy structural manganese vanadium steel	A 441
High strength low alloy columbium vanadium Steel	A 572, Grade 50
High yield strength, quenched and tempered alloy steel plate suitable for welding	A 514
High strength steel bolts, studs and threaded rods for general applications	A 449
High strength structural steel bolts, nuts and Washers	A 325
High strength low alloy structural steel	A 588
Bolts and nuts	A 307
Carbon steel for forging, pins and rollers	A 668, Class G
Alloy steel for forging	A 668, Class G
Pin nuts	A 36
Carbon-steel castings	A 27, Grade 65-35
Gray iron castings	A 48, Class 30B
Malleable iron castings	A 47, Grade 32510
Carbon steel structural tubing	A 500, Grade B or A 501
Steel pile (Hydrostatic testing will not apply) Grade B; A 106 Grade B; or A 139 Grade B	A 53, Type E or S

Stud connections through 1020 either semi- or fully skilled	A 108, grades 1010
-------------------------------------------------------------	--------------------

Table 70, Material Requirements

Structural steel designed on the plans as high strength low alloy structural steel shall conform to the following: -

Thickness	Materials-ASTM Designation
0 to 2 cms	A 441, A 572, Grade 50, A 588
2 to 5 cms	A 572, Grade 50; A 588
5 to 10 cms	A 588

- All structural steel conforming to ASTM Designations: A 36, A 441 and A 572 shall be other than rimmed or capped steel.
- Coiled steel plate shall not be used for the fabrication of flanges, eyebars and hanger plates nor for flanges and eyebars.
- All structural steel pre-cut prior to arrival at the fabrication site shall be cut so that the plate orientation complies with the requirements of these specifications.
- All structural steel plate used for the fabrication of tension flanges, eyebars and hanger plates and for splice plates of tension flanges and eyebars shall meet the longitudinal CVN impact value requirements specified herein. Sampling procedures shall conform to the provisions in ASTM Designation; A 673. The H (Heat) frequency of testing shall be used for structural steels conforming to ASTM Designations: A 36, A 441, A 572 and A 588. The P (Piece) frequency of testing shall be used for structural steel conforming to ASTM A 514. CVN impact values shall be determined in accordance with ASTM E 23.
- CVN impact values shall conform to the following minimum requirements shown in Table given below.

Material	Impact Value ft-lb at Temp. (kg-m at Temp.)
A 36	15 at 40 °F (2.07 at 4.45 °C)
A 441	15 at 40 °F (2.07 at 4.45 °C)
A 572*	15 at 40 °F (2.07 at 4.45 °C)
A 588* 2" and under in thickness (50.8mm & under in thickness)	15 at 40 °F (2.07 at 4.45 °C)
A 588* Over 2" to 4" in thickness (Over 50.8mm to 101.6mm in thickness)	20 at 40 °F (2.77 at 4.45 °C)
A 514 2 1/2" & under in thickness (63.5mm & under in thickness)	25 at 0 °F (3.46 at -17.8 °C)
A 514 Over 2 1/2" to 4" in thickness Over 63.5mm to 101.6mm in thickness)	35 at 0 °F (4.84 at -17.8 °C)

Table 71, CVN Impact Values Requirements

- *If the yield point of the material exceeds 65,000 psi (4,569.5 kg/sq. cm), the temperature for the CVN impact value for acceptability shall be reduced to 15 °F. (-

9.45 °C) for each increment of 10,000 psi (703 kg/sq. cm) above 65,000 psi (4,569.5 kg/sq. cm).

- Stud connectors shall be produced by cold heading, cold rolling or cold machining. Finished stud connectors shall be of uniform quality and free of injurious laps, fins, seams, cracks, twists, bends or other defects. Studs shall not have cracks or bursts deeper than one-half (1/2) the thickness from the periphery of the head to the shaft. Tensile strength of stud connectors shall be determined by test of bar stock after drawing or of full diameter finished studs at the option of the Contractor. Strength requirements shall conform as shown in Table given below.

Tensile Strength	Elongation	Reduction of Area (min)
(min) 60,000 psi (4,218 kg/sq. cm)	(min) 20% in 2 inches (50.8 mm)	50%

Table 72, Strength Requirements of Stud Connectors

Stud connectors shall be furnished with arc shields (ferrules) of heat-resistant ceramic or other suitable material for welding.

16.6.9.2.2 Structural Steel

- Unless otherwise specified or shown on the plans, all structural steel plates, shapes and bars shall conform to ASTM A 36.
- At the option of the Contractor, girder flange plates shown on the plans may be increased in thickness and may be increased in length provided that the change does not involve a decrease in detailed thickness of any portion of said plates. For continuous girders, increases in length of girder flange plates, which involve changes in locations of butt welds between different thickness of flange plates, shall be approved in writing by the Engineer prior to fabrication.
- When stud type shear connectors longer than twenty (20) cm are to be used, they may consist of two (2) or more shorter studs of the type shown on the plans connected together with full penetration welds.
- Rolled shapes may be substituted for the welded sections and welded sections may be substituted for the rolled shapes shown on the plans, provided that the shapes and sections to be substituted comply with the following provisions: -
- The depth, width and average thickness shall be at least equal to those for the shape or section shown on the plans.
- For welded sections, the flanges shall be welded to the web with continuous fillet welds on each side of the web. All welding shall conform to the provisions in these specifications.
- The strength classification of the material shall not be reduced.

16.6.9.2.3 Castings

Steel, gray iron and malleable iron castings shall be provided with adequate continuous fillets cast in place in all reentrant angles. The radius of curvature of the exposed surface of a fillet shall define the size of the fillet. The size of fillets shall not be less than one-half (1/2) of the thickness of the thinnest adjoining member nor less than one and one quarter (1 1/4) cm. The dimensions of the finished casting shall not be less than the specified. Castings shall not be more than seven and a half (7 1/2) % overweight. Large castings shall be suspended and hammered over their entire area. No cracks, flaws or other defects shall appear after such hammering.

16.6.9.2.4 Unidentified Stock Material

- Unidentified stock material, consisting of material that cannot be identified with certified mill test reports, may be used subject to the requirements in this Section.
- When unidentified stock material is proposed for use, the Engineer may, at his discretion, select random test specimens from each piece. Test specimens shall be cut and machined in accordance with ASTM requirements. Test specimens from unidentified stock material, including those required for retest, shall be furnished, machined and got tested by the Contractor from approved laboratory at his expense.
- Fabrication shall not be commenced until the materials involved have been approved by the Engineer.
- Not more than fourteen (14) metric tons of unidentified stock material may be used on this Contract.
- Unidentified stock material shall be segregated from all other materials to be used in the work.

16.6.9.2.5 Welding

- Welding materials, welding, welder qualification and inspection of welding shall conform to the requirements of the American Welding Society Structural Welding Code or other accepted codes as shown on the plans or as approved by the Engineer. Correction of weld faults shall be carried out in the presence of the Engineer.
- Surfaces and edges to be welded shall be smooth, uniform, clean and free of defects, which would adversely affect the quality of the weld. Edge preparation shall be done in accordance with the current ANSI/AASHTO/AWS D1.5 Bridge Welding Code.
- The presence of any of the following defects will result in rejection of the weld: -
 - Cracks, regardless of length or location.
 - Overlaps, lack of penetration or incomplete fusion.
 - Inclusions of slag, porosity and other deleterious materials less than 1.5 mm in size, unless well dispersed.
 - Inclusions outside the size limits given in Table above.
 - Any line of inclusions in a length of 12T that have an aggregate length greater than T.

Welded plate thickness (T) (mm) / Inch	Maximum allowable defect dimension (mm) / Inch
19 or less ¾"	6.5 ¼"
19-57 ¾" - 2¼"	T/3
Greater than 57 / 2¼"	19 ¾"

Table 73, Weld Defect Limits

Defects pointed out by the Inspector/the Engineer shall be removed by mechanical means or by oxygen grooving as per given instructions after which the joints shall be re-welded.

16.6.9.2.6 Galvanizing

- When galvanizing is shown on the Drawings, such galvanizing of products fabricated from rolled, pressed and forged steel shapes, plates, bars and strips three (3) mm thick or thicker, shall conform to the specifications of AASHTO M 111 (ASTM A 123), except that complete seal welding of tightly contacting surfaces of such products prior to galvanizing is required only where seal welding is shown on the plans. Except for pre-galvanized standard pipe, galvanizing of material three (3) mm thick or thicker shall be performed after fabrication into the largest practical sections.

- Galvanizing will not be required for stainless steel, mono metal and similar corrosion resistant parts.
- All welded areas shall be thoroughly cleaned prior to galvanizing to remove all slag and other material that would interfere with the adherence of the zinc. When it is necessary to straighten any sections after galvanizing, such work shall be performed without damage to the zinc coating.
- Components of bolted assemblies shall be galvanized separately before assembly. Galvanizing of tapped holes will not be required. Galvanized surfaces, which are specified to be painted, shall not be chemically treated after galvanizing and prior to cleaning and painting.

16.6.9.2.7 Cleaning

All steel works shall be blast cleaned after fabrication in accordance with the Drawings and to the satisfaction of the Engineer. Steel work that is to be in contact with concrete shall be, after fabrication, wire brushed and cleaned to remove all loose rust, dirt and grease.

16.6.9.2.8 Painting

1. Shop Coat (Prime Coat)

The shop or prime paint coat for metal structures including edges, nuts, bolts etc. shall be a factory mixed red lead Ready-Mixed Paint, AASHTO M 72. Red lead pigment in the dry form or as a paste in oil shall conform to ASTM D 83. The ninety-seven (97) % grade shall be specified for dry pigment.

2. First Field Coat (2nd prime Coat)

The first field coat shall be a red lead paint as specified for the shop coat, tinted light brown as required with lamp black in an amount not to exceed thirty (30) gm/litre of linseed oil.

3. Second Field Coat (Finish Coat)

The paint to be used for the second field coat shall be field mixed and conform, unless specified otherwise on the Drawings, to one of the following AASHTO specifications: -

- Foliage Green Bridges Paint	M 67
- Black Bridge Paint	M 68
- Aluminum Paint (Paste-Mixing Vehicle)	M 69
- White and Tinted Ready-Mixed Paint (Lead and Zinc Base),	M 70
- Red Lead (Dry and Paste-in Oil),	M 71
- Red Lead Ready-mixed Paint (Tinted with Lamp black as directed by the Engineer),	M 72

4. Number of Coats and Color

Steel shall be painted with one shop or prime coat and with not less than two field coats. The color shall be as specified or determined by the Engineer. Coats shall be different in color to permit detection of incomplete application.

5. Weather Conditions

Paint shall not be applied when the steel is damp, the air is misty, or when in the opinion of the Engineer, conditions are otherwise unsatisfactory for the work.

6. Application

Painting shall be done in a neat manner and may be applied with hand brushes or by spraying (without the addition of a thinner). Aluminium paint shall preferably be applied by spraying. By either method, the coating applied shall be smoothly and uniformly spread so that no excess paint will collect at any point.

7. Inaccessible Surfaces

All surfaces which will be inaccessible after fabrication or erection, with the exception of contact surfaces shall prior to assembly receive the full protective treatment specified for the component of the structure including any additional priming coat and finishing coats, which for accessible surfaces would be applied subsequent to erection.

8. Inspection of Cleaning and Painting

The cleaning and painting of all structural steel parts shall be subject to detailed inspection and approval of the Engineer. The Contractor shall be responsible for all defects or faults and the correction thereof at his own expense during fabrication, erection or subsequently discovered before or during the Period of Maintenance.

16.6.9.3 Construction and Fabrication Requirements

16.6.9.3.1 General

The Contractor shall submit as soon as possible to the Engineer for his prior approval, full details of their proposed fabrication and erection procedures together with details and calculations of any temporary works that the Contractor proposes to install for the purposes of erection of the structural steel work. Workmanship and finish shall be equal to the best general practice in modern bridge shops.

16.6.9.3.2 Straightening Material

Rolled material before being laid out or worked shall be straight. Subassemblies and completed members shall be straight before being incorporated into the work. If straightening is necessary, it shall be done by methods acceptable to the Engineer. Details for methods proposed for straightening shall be submitted in writing to the Engineer prior to their use. After straightening, evidence of fracture or other damage will be cause for rejection of the material. The plates, angles, other shapes, and built-up members shall be straightened without fracturing or injuring the metal. Mechanical means to straighten distorted members by applying limited, localized heat. Heat straightening of AASHTO M 270M/M 270 Grades 70W, 100, and 100W (485W, 690, and 690W) steel members will be performed only under rigidly controlled conditions subject to approval. The temperature values shall not exceed as specified in Table given below.

Material to Be Straightened	Maximum Temperature (°C)
Grade 485W > 150 mm from weld	565
Grade 485W < 150 mm from weld	480
Grade 690 and 690W > 150 mm from weld	595
Grade 690 and 690W < 150 mm from weld	510

Table 74, Maximum Straightening Temperature

- The maximum straightening temperature for all other steels is 1,200°F (650°C). Temperature shall be measured by using temperature-indicating crayons, liquids, or bimetal thermometers. The Engineer will reject material heated in excess of the specified limits unless testing verifies material integrity.
- The Engineer will ensure that parts to be heat-straightened are free of stress and external forces, including stresses from mechanical means used to apply the heat.

16.6.9.3.3 Abutting Joints

Mill or saw cut abutting ends in compression members of trusses and columns to provide a square joint and uniform bearing. The maximum opening in unfaced joints is 3/8 in. (10 mm).

16.6.9.3.4 Cutting with Torch

Torch cutting shall conform to the requirements for preparation of material to the American Welding Society's Structural Welding Code or equivalent.

16.6.9.3.5 Facing and Bearing Surface

Surface of bearing and base plates and other metal bearing surfaces that are to come into contact with each other or with ground concrete surfaces or with asbestos sheet packing shall be flat to within three-tenths (0.3) cm and to within one and six-tenths (1.6) mm tolerance overall. Surface of bearing and base plates and other metal bearing surfaces that are to come in contact with preformed fabric pads, elastomeric bearing pads or Portland cement mortar shall be flat to within three (3) mm tolerance in thirty (30) cm and to within five (5) mm tolerance overall. Steel slabs where not in contact with other metal bearing surfaces may be hot-straightened in lieu of machining at the option of the Contractor, provided the above tolerances are met. The surface shall be finished for bearing, base plates, and other bearing surfaces that contact each other or concrete as specified in Table given below.

Bearing Surface	Surface Roughness Value in. × 10 ⁻⁶ (μm)
Steel slabs	2000 (50)
Heavy plates in contact in shoes to be welded	1000 (25)
Milled ends of compression members, milled or ground ends of stiffeners and fillers	500 (12.5)
Bridge rollers and rockers	250 (6)
Pins and pin holes	125 (3)
Sliding bearings	125 (3)

Table 75, Surface Roughness Values

16.6.9.3.6 Fit of Stiffeners

Girder stiffeners designated on the Drawings as bearing stiffeners shall be welded in accordance with details shown on the Drawings. Where the end of a stiffener is shown as "Tight-fit" on the plans, the end of the plate shall be so fitted that it bears on the girder flange with at least point bearing. Local clearances between the end of the stiffener and the girder flange shall not exceed one and six-tenths (1.6) mm. Except where stiffeners are cut back, local clearances between the end of the stiffener and the girder flange which are too great to be sealed by the paint film shall be caulked prior to painting.

16.6.9.3.7 Plates

1. Direction of Rolling

Steel plates for main members shall be cut and fabricated for main members and shall be spliced for flanges and main tension members so the primary direction of rolling is parallel to the main tensile and/or compressive stresses.

2. Plate Cut Edges.

The plates shall be planed, milled, ground, or thermal cut to a depth of 1/4 in. (6 mm) the sheared edges of plates more than 5/8 in. (16 mm) thick that carry calculated stress.

3. Oxygen Cutting.

Oxygen cutting shall conform the requirements of AASHTO/AWS D1.5M/D1.5 Bridge Welding Code.

4. Visual Inspection and Repair of Plate Cut Edges.

Shall conform the requirements of AASHTO/AWS D1.5M/D1.5 Bridge Welding Code.

5. Bent Plates

Plates to be bent shall be taken from the stock plates to ensure the bend line is at right angles to the direction of rolling. Cold bent ribs for orthotropic deck bridges shall be bent with the bend lines in the direction of rolling only with approval. Before bending, the plate corners shall be rounded to a 1/16-in. (1.5mm) radius where the bend are placed.

6. Cold Bending

The plate shall be cold bended steel without cracking. The minimum bend radii specified in Table below shall be used, measured to the concave face of the metal.

Plate Thickness, in. (mm)	Bending Radius (for all grades of structural steel)
Less than 1/2 (12)	2t
Over 1/2 to 1 (12 to 25)	2.5t
Over 1 to 1 1/2 (25 to 38)	3t
Over 1 1/2 to 2 1/2 (38 to 60)	3.5t

Table 76, Minimum Bend Radii

7. Hot Bending

Bend radii smaller than the minimum specified for cold bending with the plates at a temperature less than 1,200°F (650°C), excluding AASHTO M 270M/M 270, Grades 70W, 100, and 100W (485W, 690, and 690W) steel. Plates shall be requenched and tempered Grades 100 and 100W (690 and 690W) steel when the steel to be bent is to be heated higher than 1,100°F (595°C).

16.6.9.3.8 End Connection Angles

Floor beams, stringers and girders having end connection angles shall be built to exact length back to back of connection angles. If end connections are faced, the finished thickness of the angle shall not be less than that shown on the detailed Drawings.

16.6.9.3.9 Finished Members

Finished members shall be true to line and free from twists, bends and open joints.

16.6.9.3.10 Screw Threads

Screw threads shall make close fits in the nuts and shall be American Standard Form, except that for pin ends of diameters greater than 3.81 cm (1 1/2 inches) they shall be made with six (6) threads to 2.54 cms (1 inch).

16.6.9.3.11 Match – Marking

Connecting parts pre-assembled for the purpose of setting up for welding or for drilling or reaming holes for field connections shall be match-marked and a diagram showing such marks shall be furnished to the Engineer.

16.6.9.3.12 Finish

Portions of the work exposed to view shall be finished neatly. Shearing, flame cuffing and chipping shall be done carefully and accurately. All sharp corners and edges and edges that are marred, cut or roughened in handling or erection shall be slightly rounded by grinding or other suitable means.

16.6.9.3.13 Bolted Connections

- Bolted connections unless otherwise shown on the Drawings shall be made with high-strength steel bolts conforming to ASTM A 325. All bolts shall be installed with a hardened washer under the nut or bolt head, whichever is the element turned in tightening.
- Bolts may be tightened to the required tension by use of a calibrated manual torque wrench, the turn-of-nut method or by tightening and using direct tension indicators. The torque value or the direct tension indicator gap needed to develop the bolt tension will be determined by the Engineer. Checking of bolt tension shall be done by the Contractor in the presence of the Engineer and in such a manner that the Engineer can read the torque wrench gauge or direct tension indicator during checking.
- Nuts shall be located, wherever practicable, on the side of the member, which will not be visible from the traveled way. Nuts or bolts that will be partially embedded in concrete shall be located on the side of the member that will be encased in concrete.

16.6.9.3.14 Bolt Holes

- Bolt holes shall be either punched full size, drilled full size, sub-punched and reamed, or sub-drilled and reamed.
- Attention is diverted to the provisions in Section 8-5.9 "Assembly" and details shown on the Drawings for connections where drilling or reaming is required after the joint is assembled.
- The finished holes shall be cylindrical, perpendicular to the plane of the connection and shall not be more than one and a half (1 1/2) mm larger than the nominal diameter of the bolt. Holes shall be clean cut, without torn or ragged edges. All burns, fins, sharp edges and hole irregularities which Would prevent solid seating of the parts shall be removed.

- All holes punched full size, sub-punched, or sub-drilled shall be located with sufficient accuracy so that after assembling (before any reaming is done) a cylindrical pin three (3.0) mm smaller in diameter than the nominal size of the punched, sub-punched, or sub-drilled hole may be passed through the hole without drifting in at least seventy-five (75) % of the holes for each connection. All holes shall pass a pin four and a half (4½) mm smaller in diameter than the nominal size of the hole.
- Mis-punched or mis-drilled holes shall not be corrected by welding unless approved by the Engineer.
- Punching, drilling and reaming shall conform to the following: -

1. Punching

- Punching or sub-punching of structural steel conforming to ASTM A 26 where the material is thicker than two and a quarter (2¼) cm 7/8" will not be permitted. Punching or sub-punching of high strength structural steel where the material is thicker than two (2) cm 0.63" will not be permitted.
- Holes sub-punched for reaming shall be sub-punched decimal six five (0.65) cm less in diameter than that of the finished hole.

2. Drilling

- Drilling full size shall be done with the parts assembled on to, a steel template with hardened bushings or may be performed with gang drill equipment if approved by the Engineer. The Engineer may require a proof assembly to check the fit of major field connections.
- Where bolt holes are sub-drilled for reaming, they shall be sub-drilled decimal six five (0.65) cm less in diameter than that of the finished hole.
- Drilling through templates shall be performed only after the templates have been accurately placed and firmly clamped or bolted.
- If members are drilled while assembled, the parts shall be held securely together while drilling is being done.
- Stock drilling of plate parts with precision gang drills will be permitted if all parts are firmly clamped during drilling and if the drill bits remain perpendicular to the work during drilling operations.

3. Reaming

- Reaming shall be done after the pieces forming a built-up member are assembled and are firmly bolted together so that the surfaces are in close contact or after templates are securely located over the member. The pieces shall be taken apart before bolting, if necessary and shavings removed. If it is necessary to take the members apart for shipping or handling, the pieces reamed together shall be so marked in order that they may be reassembled in the same position. Reamed parts shall not be interchanged.
- Reaming templates shall have hardened steel bushings and holes accurately dimensioned. Templates shall have reference lines, which will permit accurate location of the template on the member or members to be reamed. Templates used for reaming shall be properly located on the material and shall be firmly clamped or bolted in position. Templates used for the reaming of matching members, or the opposite faces of one member, shall be exact duplicates.
- Holes through assembled materials that are to be reamed shall not consist of both sub-punched or sub-drilled holes and holes punched or drilled full size.

16.6.9.3.15 Pin Connections

- Pins shall be accurately turned to the dimensions shown on the plans and shall be straight, smooth and free from flaws. The final surface shall be produced by a finished cut.
- Pins and rollers shall be forged and heat-treated in accordance with the designation shown on the plans.
- If pins are larger than twenty-three (23) cm in diameter, a hole not less than four and three quarters ($4\frac{3}{4}$) cm in diameter shall be bored full length along the axis after the forging has been allowed to cool to a temperature below the critical range under suitable conditions to prevent injury by too rapid cooling and before being annealed.
- Holes for pins shall be bored true to the specified diameter, smooth and straight, at right angles to the axis of the member and parallel with each other unless otherwise required. The final surface shall be produced by a finishing cut.
- Machined surfaces for pins and holes shall be coated with a rust inhibitor that can be easily removed.
- The distance outside-to-outside of holes in tension members and inside-to- inside of holes in compression members shall not vary from that shown on the plans by more than eight-tenths (0.8) mm.
- The diameter of the holes for pins shall not exceed that of the pins by more than half ($1/2$) mm for pins thirteen (13) cm or less in diameter, or eight-tenths (0.8) mm for larger pins.
- Holes for pins in built-up members shall be bored after assembly of the member, or may be bored prior to assembly, provided procedures approved in advance by the Engineer are followed which result in such holes being positioned to the same degree of accuracy as would be obtained if the holes were bored after assembly.
- Pin-connected hangar plates shall be bored in pairs or in stacks firmly bolted or clamped together so that each pair of hangar plates is matched. Pilot and driving nuts shall be used in driving pins. Pins shall be so driven that the members will take full bearing on them. In field assembling, the pin nuts on pin connections shall be tightened and the threads burred at the face of the nuts with a pointed tool.

16.6.9.3.16 Anchor Bolts

- No anchor bolts shall be cast in the concrete.
- Anchor bolts shall be set in round holes drilled or cast in the masonry. The size and length of bolts shall be as indicated on the Plans.
- Bolts shall be accurately positioned by means of templates set to correct location and alignment so as to ensure proper span lengths and tops of bolts shall be carefully set to proper elevation. Unless otherwise noted, bolts shall be installed plumb or normal to the finished bearing surface of the masonry.
- When anchor bolt holes are drilled, a template shall be used to locate the bolts accurately and permit reinforcing steel bars to be shifted clear of holes before pouring concrete to prevent cutting these bars during drilling. The drilling shall be done prior to the erection of structural steel.
- Bolts set in holes drilled or cast in the masonry shall have the portion below the bridge seat swedged and the drilled or cast holes shall have a diameter at least one 1 inch (25 mm) in excess of the diameter of the bolt.
- Anchor bolts for steel stringers for all bridges (weathering steel and/or painted steel) shall be A 36 galvanized steel and shall not be painted. The nuts and washers used on anchor bolts shall also be galvanized and shall not be painted.
- Holes cast in the masonry for swedged bolts shall be formed with removable round sleeves sealed at their lower ends and they shall be completely removed after the hole is cast. During cold weather, effective methods shall be used to prevent the freezing of water in anchor bolt holes.

- After anchor bolts are finally and correctly positioned, the holes around them shall be completely filled. No grouting of anchor bolts will be permitted until all structural steel is set in its final position. After the masonry plates or shoes are set, the space between the bolts and the round holes through fixed plates or shoes shall also be filled with the same material. Slotted holes in expansion devices shall remain unfilled to allow free movement.
- Mortar used for grouting anchor bolts shall be composed in accordance with one of the following: -
 - One-part Portland Cement and one-part mortar sand by dry loose volume.
 - Non-shrink grout shall be used when specified. The grout shall have a minimum compressive strength of 350 kg/sq. cm (5,000 psi) in seven days when tested in accordance with AASHTO T 106 except that the cube moulds shall remain intact with a top firmly attached throughout the curing period. The non-shrink grout shall not show any expansion after seven days when tested in accordance with AASHTO T 160.
 - When air temperature is below four (4) °C, the Contractor shall provide adequate cold weather protection to maintain a minimum air temperature of four (4) °C around surface of mortar for a period of three days.
 - If anchor bolts are mortared in place during cold weather, the bolts and surrounding masonry shall be kept at a minimum temperature of four (4) °C for a period of three days.
 - When mortar filling is used for bolts inserted in holes drilled or cast in the masonry, the holes shall first be checked for depth by inserting and withdrawing the bolts. They shall then be partially filled with mortar into which the bolts shall be forced by uniform pressure or light blows from a hammer (flogging and running will not be permitted) so that excess mortar is pushed out at the top of the hole. The excess mortar shall be removed and finished off flush with the top surfaces of the masonry, masonry plate or shoe as the case may be.
 - Bolts shall be set to project approximately half (½) inch (13 mm) above the nut and shall be threaded to approximately half (½) inch (13 mm) below the nut in its final position.
 - Nuts shall be drawn up tight except over the slotted holes of expansion devices in which case they shall be positioned half (1/2) inch (13 mm) clear of the moveable parts. All anchor bolt threads shall be burred with a sharp pointed tool at the top of the nut. When nuts are set half (1/2) inch (13 mm) clear of moveable parts, the bolt thread shall also be burred immediately under the nut to prevent it becoming tight against the moveable parts.
 - Rockers or expansion plates with slotted holes shall be set with the proper tilt or offset as determined by the temperature prevailing at the time and so that they will be in their midway position at twenty (20) °C or as indicated on the Drawings.

16.6.9.3.17 Assembly and Erections Procedure

1. General

The Contractor shall submit as soon as possible to the Engineer for his prior approval full details of their proposed erection procedure together with details and calculations of any temporary works that the Contractor proposes to install for the purposes of the erection of the structural steel work.

2. Storage at Site and Handling

The structural steelwork after arrival on Site shall be laid out in the area allocated by the Contractor. It shall be unloaded by crane, or other appliance and carefully stacked on timbers and subsequently handled for erection in such a manner that no distortion or damage is done to the various members. No steelwork shall be stored directly on the ground.

3. Erection Generally

The works on Site shall comply with the requirements stated in these Specifications and the Contractor shall be responsible for providing all materials, skilled and unskilled labor, plant, equipment, supervision and all other things necessary for the erection of the steelwork on the Site as specified in the Contract Documents and shown on the Drawings. The Contractor shall ensure that suitable plant and equipment of adequate capacity is used on the Site.

4. Supervision

The erection of the steelwork shall be under the direct charge of a competent Supervisor who has had sound experience in the erection of structural steelwork and who shall work full time on the Site from start to completion of the work.

5. Security During Erection

During erection the work shall be securely bolted or otherwise fastened and where necessary temporarily braced, so as to make adequate provision for all erection stresses and conditions, including those due to the erection equipment and its operation. Each part of the structure shall be aligned as soon as possible after it is erected. Members shall not be permanently connected until the structure has been sufficiently aligned, leveled, plumbed and temporarily connected to ensure that they will not be displaced during the erection or alignment of the remainder of the structure. All temporary bracing shall be left in position until such time as erection is sufficiently far advanced for it to be no longer required.

6. Temporary Connections

Connections for temporary bracing and additional holes, members or cleats used to facilitate handling or erection shall be provided in a manner, which does not weaken the permanent structure or impair its serviceability.

7. Erection Packs etc.

The Contractor shall provide and shall be deemed to have included in his rates and prices for providing a suitable range of steel erection packs, shims and wedges to be used as necessary to ensure the accurate adjustment of line and level of the steelwork erected on Site and for the temporary works referred to in the previous sub-item.

8. Setting Out

The Contractor shall be responsible for the final positioning, leveling, plumbing and alignment of all steelwork and the accurate placing of every part of the steelwork in accordance with the Drawings and his own fabrication drawings. No steelwork shall be finally concreted until the positioning, levels, plumbing and alignment of the steelwork (or part of the steelwork if agreed by the Engineer) has been finally checked by the Contractor.

9. Work on Site

The steelwork after erection and fixing complete shall comply with the following maximum permissible dimensional tolerances: -

- Departure from overall plan dimensions at any level ten (10) mm.
- Departure from theoretical centers of adjacent beams or girders in any floor or roof five (5) mm.
- Departure from the true alignment of any plate girder relative to the associated setting out geometry shown on the Drawing five (5) mm.
- Departure from the true vertical center line or any girder throughout its length of height five (5) mm.
- Departure from the specified level of the top of any beam five (5) mm.

10. Site Connections

- The Contractor shall make all Site connections in accordance with the details shown on the Contractor's detailed fabrication drawings, which shall comply with the requirements of these Specifications. Drifting shall not be used to correct a bad alignment.
- Any additional holes required in the steelwork (which must first be approved by the Engineer) shall be drilled on the Site. Burning holes in the steelwork will not be permitted.

11. Contact Surfaces

All steel to steel contact surfaces shall be thoroughly cleaned and painted with two coats of primer. The surfaces shall be brought together while the second coating is still tacky.

12. Site Welding

Site welding will only be permitted where shown on the Drawings and with prior consent of the Engineer.

13. Inspection of Site Works

- All parts of the steel work will be subjected to inspection by the Engineer. The Contractor shall afford all facilities and assistance for inspection during the progress of the Works.
- The Contractor shall whenever possible, give the Engineer at least twenty-four (24) hours' notice of when materials or parts of the steelwork will be ready for inspection.
- Materials or workmanship or parts rejected shall be remedied or replaced by the Contractor without extra charge and without affecting the time for completion of the Contract.
- Inspection as aforesaid by the Engineer shall not absolve the Contractor from being responsible for any error or fault that may be discovered subsequently and for the final accuracy of the Works.

14. Painting after Erection

- All paints shall be applied in accordance with the manufacturer's instructions.
- Damaged areas of paintwork shall be thoroughly scraped, wire-brushed and cleaned to remove all rust, dirt, grease and loose primer, back to sound paint.
- All surfaces shall be thoroughly cleaned prior to further painting.
- Damaged areas shall then be treated as described in the cleaning and painting section.

- The second priming coat shall be allowed to dry for at least twenty-four hours before application of the finishing coat.

15. Inspection

- The structural steelwork shall be subject to inspection by the Engineer. That inspection will as far as possible be carried out at the Contractor's workshops, but the Engineer may at his discretion defer inspection of any parts of the structural steelwork until after those parts have been delivered to the Site. The Contractor and his suppliers shall afford the requisite facilities at all reasonable times and at all places for inspection and testing to be carried out by the Engineer.
- All parts of the Works done on the Site will be subjected to inspection by the Engineer. The Contractor shall afford all facilities and assistance for inspection as aforesaid during the progress of the Site Works and until the completion of the Contract.
- Materials or workmanship or parts rejected on inspection as aforesaid shall be remedied or replaced by the Contractor without extra charge and without affecting the time for completion of the whole or any part of the Works.

16.6.9.4 Measurement and Payment

16.6.9.4.1 Measurement

The quantity to be paid for shall be measured for different sized (cross-section) members separately in running foot / running meter and then multiplied by its theoretical unit weight of the relevant steel section in lbs. / kg if the tested weight is within permissible variation limit of + 6% and if the tested weight difference is more than 6%, the weight will be arrived at the actual weight if in minus and if the tested weight is more than +6% then the theoretical weight will be considered. Including the weight (mass) of heads, nuts, single washers and threaded stick-through of all high tensile strength bolts, both shop and field, and the basis of Table below.

16.6.9.4.2 Payment

The pay item shall include fabrication, erection and protective coating (painting). The measurement shall be the total weight of the finished member comprising plates, rolled sections, shear connectors, stiffeners, cleats, packs, splice plates and all incidentals necessary to complete the item, without allowance for tolerance for rolling margin and other permissible deviations from standard weights and excluding the weights of welds, fillets, bolts, nuts, washers and protective coatings. No deductions shall be made for notches, holes and the like each less than decimal zero one (0.01) sq. m measured in area.

Fabrication shall include: -

- Preparation and supply of shop drawings.
- Examining and checking steel plates for segregation, laminations, cracks and surface flaws and carrying out any remedial measures required by the Engineer in respect of such defects.
- Cutting, marking off, drilling, notching, machining, form fitting, edge preparation and cambering.
- Welding, riveting, bolting as the case may be, assembling and pre-heating.

- Bolts, nuts and washers required to fabricate the steelwork and to complete the erection and installation of steelwork on Site, together with spares and service bolts, drifts, draw-up cleats and the like.
- The measurement will include the weight (mass) of heads, nuts, single washers, and threaded stick-through of all high tensile strength bolts, both shop and field, on the basis of Table below: -

Designation	Bolt Diameter	Mass/100 Bolt Kg (lbs.)	Over Size Limit Inch (mm)
M16	1/4" (6mm)	14.4 (31.74)	0.016 (0.4)
M20	5/16" - 3/8" (8mm) to (10mm)	23.8 (52.46)	0.017 (0.43)
M22	7/16" - 1/2" (10.5 mm) to (13mm)	36.5 (80.45)	0.018 (0.45)
M24	9/16" - 3/4" (13.5 mm) to (20mm)	53.0 (116.81)	0.020 (0.50)
M27	7/8" (22 mm)	75.0 (165.3)	0.022 (0.55)
M30	1.0" - 1 1/4" (25 mm) to (31.25 mm)	96.4 (212.46)	0.024 (0.60)
M36	1 3/8" - 1 1/2" (34 mm) to (38 mm)	127.3 (280.57)	0.027 (0.67)

Table 77, Mass per 100 Bolts (SI Units)

Welding shear connectors to steel members either at the place of fabrication or on Site and preheating as per Table below.

Fillet Weld	Mass Lb./ft (kg/m)
3/16" (5mm)	0.08 (0.12)
1/4" (6mm)	0.14 (0.21)
5/16" (8mm)	0.22 (0.33)
3/8" (10mm)	0.30 (0.45)
1/2" (12mm)	0.55 (0.82)
5/8" (16mm)	0.80 (1.19)
3/4" (20mm)	1.10 (1.64)
7/8" (22mm)	1.49 (2.23)
1" (25mm)	2.00 (2.98)

Table 78, Mass of Fillet Welds

- Approval testing of welders.
- Production tests of welding during fabrication including nondestructive testing.
- Marking members for identification and delivery in matching sequence.

Permanent Erection shall include: -

- Temporary bracing or stays to prevent displacement including the provision and removal of temporary attachments.
- Approval testing of welders.
- Permanent bolted and welded connections required on Site including the provision of preheat and shelters for welding.
- Production tests of Site welding including non-destructive testing.

Protective Coating shall include: -

- Specimen panels of blast cleaning.
- Paint samples and dispatching to testing authority.
- Paint application procedure trials.
- Testing.
- Masking and other measures to protect adjacent untreated steelwork.
- Joint fillers and sealing of bolted joints.
- Preparing materials for application.
- Preparation of surfaces and painting of steelwork at the place of fabrication and on Site.
- Complying with any special requirements in respect of ambient conditions for the application of protective treatment and for intervals between successive operations and applications.
- Strip coats.

Pay Item No.	Description	Unit of Measurement
16.6.9.4.2.1	Structural Steelwork	M. Ton

16.6.10 Piles

Please refer to chapter 18 of Book - 2 of these specifications.

16.6.11 Brick Masonry

16.6.11.1 Description

The work specified in this section shall consist of providing all materials, equipment and labour required for constructing brickwork. All brickwork shall be first class and finished in a workman like manner, true to dimensions and grades shown on the drawings according to these specifications.

16.6.11.2 Materials

1. Bricks

The size of bricks shall be standard size 22.9 cm x 11.4 cm x 7.6 cm (9"x 4 1/2" x 3"). They shall be well-bunt without being vitrified. They shall be of uniform colour, regular in shape and size with sharp and square corners and parallel faces. They must be homogenous in texture and emit a clear ringing sound when struck. They shall be free from flaws and cracks. They shall not absorb more than 1/6th of their weight of water after being soaked for one hour, and shall show no signs of efflorescence on drying. Compressive Strength shall not be less than 140 Kg/cm²(2000 Psi). Brick masonry construction shall conform to the Specifications AASHTO M114 (ASTM C62).

2. Portland Cement

Portland cement shall conform to the requirements for Chapter-3 of Book-1(Specification for Engineering Material).

3. Sand

Sand for mortar used in brickwork shall conform to the requirement for the fine aggregate.

4. Water

The water used in the preparation of mortar shall be free from objectionable quantities of silt, organic matter, salts or other impurities. No water shall be used without the written approval of the Engineer.

5. Tools and Scaffolding

- All equipment used for mixing mortar, transporting it and for laying bricks shall be clean and free from set mortar, dirt, or other injurious foreign substances. It shall be thoroughly cleaned at the end of each day's work.
- The contractor shall provide all scaffolding, staging, and ladders, necessary for the work. All walls or others brickwork shall be securely braced and protected against damages by wind and storm during the construction period. No extra rate shall be paid for this item.

6. Bond

Unless otherwise specified, all brickwork shall be laid in English Bond with frogs upward.

16.6.11.3 Construction Requirements

16.6.11.3.1 Mixing of Mortar

- Methods and equipment used for mixing mortar shall be such that each ingredient entering into the mortar shall be subject to the approval of the Engineer. If a mixer is used, it shall be of approved design and the mixing time after all the ingredients are in the mixer, except the full amount of water, shall be not less than two minutes.
- Mortar shall be mixed only in sufficient quantities for immediate use. All mortar not used within thirty (30) minutes after addition of the water to the mix shall be wasted. Retempering of mortar will not be allowed. Mixing troughs and pans shall be thoroughly cleaned and washed at the end of each day's work.

16.6.11.3.2 Brick Laying

- Brick work shall not be placed during heavy or prolonged rain to wash the mortar from the bricks. Mortar already spread, diluted by rain shall be removed and replaced before restoring the work.
- All bricks to be used in brickwork with mortar joints shall be immersed in water from three (3) to four (4) hours before use.
- All bricks shall be skillfully laid with level courses, uniform joints, square corners, plumb verticals and true surface, except where otherwise shown on the Drawings.
- All walls and abutments shall be provided with weep holes. Unless otherwise shown on the Drawings or directed by the Engineer, the weep holes shall be placed at the lowest points where free outlets can be obtained and shall be spaced not more than two (2) m center to center.
- All surfaces exposed to weather, shall be struck pointed to give a good workmanlike appearance and to seal the cavities in mortar joints.

16.6.11.3.3 Curing

All brickwork shall be cured for at least seven (7) days after laying. The curing method shall be to the satisfaction of the Engineer.

16.6.11.3.4 Progress

Brickwork shall be carried up in a uniform manner. No portion shall be raised more than one meter (3 feet) above another at the same time. Temporary spaces left during construction shall be raked and not toothed. The brick layer shall be provided with measuring rods or straight edge having courses marked on them with saw and the height of courses shall be checked all over, during from time to time so as to keep all courses level.

16.6.11.3.5 Putlogs

Only headers shall be left out to allow a putlog to be inserted and not more than one brick shall be left out for each putlog. Under no circumstances shall putlogs be made immediately under or next to the impost or skew back of arches.

16.6.11.3.6 Joints

- Horizontal joints shall be parallel and truly level.
- Vertical joints in alternate courses shall come directly over one another. Thickness of joints, unless otherwise specified, shall not be less than 6.3 mm (1/4") and shall not be more than 9.5 mm (3/8'). The height of 4 courses and 3 joints as laid shall not exceed more than 25 mm (1 inch) the height of 4 bricks as piled dry one upon the other.

1. Jointing Works

When fresh masonry is to join masonry that has partially or fully set, the exposed joining surface of the set masonry shall be cleaned, roughened and wetted so as to affect the best possible bond with the new work. All loose bricks and mortar shall be removed.

2. Striking of Joints

Where in the case of brickwork in cement mortar, pointing or plastering to the face work is not provided as a separate item the joints in face work shall be struck. This operation shall be paid for separately.

3. Raking Joints

The joints of brickwork, which is to be pointed or plastered, shall be raked out with a hook to a depth of 12.5 mm (1/2'). The raking shall be done before the mortar sets each day.

16.6.11.3.7 Corners

- At all corners alternate courses of bricks shall be laid header wise and stretcher-wise so as to bond the two walls together.
- Where particularly required, cut or mould bricks shall be used in jambs, arches and projecting corners, so as to eliminate sharp angles from the inside of a building. This shall be included in the unit rate if the radius of the finished (Plastered) corners does

not exceed 19 mm (3/4 of an inch). In case it exceeds 19 mm (3/4 of an inch) extra payment shall be made by marking linear measurements.

16.6.11.3.8 Round Pillars

Round pillars shall be built with quadrant shaped bricks, if the pillars are of considerable height flat circular discs of stone or cement concrete of the same diameter as the pillar and about 75 mm (3 inches) thick shall be introduced at every 1.0 m to 2 m (3 to 6 feet) as bond stone. The cost of this operation will be included in the unit rate.

16.6.11.3.9 Plumb Bobs and Straight Edges

All brickwork shall be truly plumbed and each set of 4 brick course shall be checked with plumb bob and straight edge.

16.6.11.3.10 Face Work

All face work shall be finished with neat drawn joints and pointed out if it has not been plastered. If it has to be plastered the joints shall be raked out before any plaster is laid on. For face work the bricks shall be of true edges, uniform colour and correct dimensions. If specially required, face work shall be laid up with pressed bricks. It shall be measured and paid for separately. All brick courses shall be proportioned that they will work out evenly with the height of windows and doors.

16.6.11.3.11 Cut Brick Work

Bricks shall be cut, dressed or grooved, as required for architectural features. Corners shall be made with cut bricks.

16.6.11.3.12 Fixtures

Holdfasts and similar fixtures shall be built in with the surrounding brickwork in their correct position in specified mortar. They shall be built in as the work progresses and not inserted later on into space left for them.

16.6.11.3.13 Bed Plates

Bed plates of concrete or stone shall be provided under each beam and joint. They shall conform to the dimensions given in the drawings and shall be carefully laid in specified cement mortar to correct level.

16.6.11.3.14 Centering

Centering for all openings shall be strong enough to support the lintels of arches spanning the opening. They shall be subject to the approval of the Engineer In charge and shall remain in position till the brickwork has set. No additional payment will be made to the contractor for this item of work.

16.6.11.3.15 Brickwork in Arches

The brickwork in arches shall conform to specifications for first class brickwork, but shall not commence till abutments have been built to their full width and up to the level of skew backs. Arch work shall be carried up evenly from both abutments and as soon as the arch is complete, masonry shall be built up evenly on both sides to the heights of crown so as to load the haunches.

16.6.11.4 Measurement and Payment

16.6.11.4.1 Measurement

Brickwork shall be measured by volume. The unit of measurement shall be 1 cubic meter. The measurement of cut bricks shall be in number. The unit of measurement shall be 1000 bricks. The item of coping shall be measured by length. The unit of measurement shall be one linear meter or one linear foot.

16.6.11.4.2 Payment

The unit rate shall be full compensation for carrying out 1st class brickwork including the cost of bricks mortar and any other material required, including curing and protection as per above specifications. It shall further include the cost of providing using and removing scaffolding, shuttering, centering, staging, ladders, supports and other tools and plants, required for carrying out 1st class brickwork. Payment shall be made under: -

Pay Item No.	Description	Unit of Measurement
16.6.11.4.2.1	1 st class brick work in Cement Mortar as Specified.	Cu. Ft or M ₃
16.6.11.4.2.2	Coping in Specified Cement Concrete of Specified Strength	Cu. Ft or M ₃
16.6.11.4.2.3	Brick work in Arches	Cu. Ft or M ₃
16.6.11.4.2.4	Cut Bricks	Nos.
16.6.11.4.2.5	Cement Sand Plaster of Specified Ratio	Sq. or M ₂

16.6.12 Random and Dressed Un coursed Stone Masonry

16.6.12.1 Description

The Section shall consist of Random and Dressed un coursed Stone Masonry with or without mortar. Dimensions of such masonry may vary as per the Drawings or as directed by the Engineer.

16.6.12.2 Material Requirement

1. Stone

Random or dressed stone shall be of approved quality, sound and durable, free from segregation's, seams, cracks and other structural defects or imperfection tending to reduce its resistance to weather. It shall be free from rounded or weathered surfaces.

2. Mortar

Mortar for laying stone and pointing shall be composed of one part of Portland cement and four parts of sand unless otherwise shown on the Drawings. Portland cement shall meet the

requirements of AASHTO M 85 and sand shall meet the requirements of AASHTO M 45. Water used in preparation of mortar shall conform to the requirement.

16.6.12.3 Construction Requirements

16.6.12.3.1 Stone Size and Shape

- Individual stones shall have a thickness of not less than twenty (20) cm and a width of at least one and a half ($1\frac{1}{2}$) times the thickness and length of at least one and a half ($1\frac{1}{2}$) times their width
- Shape of stones may be irregular in random masonry, however for dressed uncoursed masonry, stones shall be cut in such a way that a well locked masonry can be laid. The size and shape of ring stones for arches shall be as shown on the Drawings.

16.6.12.3.2 Dressing of Stones

- For "A Class" Masonry, Stones shall be dressed to exact sizes and shapes and cut to lay on beds with top and bottom truly parallel. Hollow beds shall not be permitted. Beds of face stone shall be fine finished for a depth of not less than thirty (30) cm. Vertical joints of face stone shall be fine finished and full to the square for a depth of not less than twenty-five (25) cm.
- Exposed surfaces of face stone shall be according to the plans, with edges pitched to true lines and exact batter, chisel drafts four (4) cm wide shall be cut at all exterior corners.
- Stones for B Class Stone Masonry shall be roughly squared on joints, beds and faces. Selected stones, roughly squared pitch to line shall be used at all angles and ends of wall.

16.6.12.3.3 Stretchers

Stretcher shall have a width of bed not less than one and a half ($1\frac{1}{2}$) times their thickness and length of bed not less than twice nor more than three and a half ($3\frac{1}{2}$) times their thickness but in no case less than ninety (90) cm. Stone masonry in cement mortar shall be cured for at least seven (7) days.

16.6.12.3.4 Headers

Header, placed in each course, shall have width not less than one and a half ($1\frac{1}{2}$) times their thickness. In walls having thickness of 1.2 meters or less, the headers shall extend entirely through the wall. In walls of greater thickness, the length of headers shall be not less than two and a half ($2\frac{1}{2}$) times their thickness when the course is forty-five (45) cm or less in height and not less than 1.2 meters in courses of greater height. Header shall bond with the core or backing not less than thirty (30) cm. Header shall hold in the heart of the wall spaced not further apart than two and a half ($2\frac{1}{2}$) m center to center, there shall be at least one header to every two stretchers.

16.6.12.3.5 Cores and Backing

Core and backing shall consist either of roughly bedded and jointed headers and stretchers, as specified above or concrete as may be specified. When stone is used for cores of backing, at least one-half ($1/2$) of the stone shall be of the same size and character as the face stone and with parallel ends. No course shall be less than twenty (20) cm thick. Concrete used for

cores and backing shall conform to the requirements specified in Section 7-1. The headers and stretchers in walls, having a thickness of one meter or less shall have a width or length equal to the full thickness of the wall. No backing will be allowed.

16.6.12.3.6 Stone and Arches

It shall conform to the requirement as specified in Stone Masonry in Chapter-8 of Book-2.

16.6.12.4 Measurement and Payment

16.6.12.4.1 Measurement

- The quantity of stone masonry to be paid for shall be the number of cubic meters measured in the completed work and the limiting dimensions shall not exceed than those shown on the Drawings or fixed in writing by the Engineer.
- Class C or lean concrete shall be measured separately as per dimensions shown on the Drawings or as directed by the Engineer. No separate measurement shall be made for stuck pointing, which is deemed to be included in stone masonry with mortar, however roll pointing shall be measured separately in square meter.

16.6.12.4.2 Payment

The accepted quantities measured as provided above shall be paid for at the Contract unit price respectively for the pay items listed below and shown in the Bill of Quantities, which price and payment shall constitute full compensation for labor, materials, equipment and incidentals necessary to complete the work prescribed in this Section: -

Pay Item No.	Description	Unit of Measurement
16.6.12.4.2.1	Stone Masonry Random Dry	Cu.ft or M ₃
16.6.12.4.2.2	Stone Masonry Random with Mortar	Cu.ft or M ₃
16.6.12.4.2.3	Stone Masonry Dressed Uncoursed Dry	Cu.ft or M ₃
16.6.12.4.2.4	Stone Masonry Dressed Uncoursed with Mortar	Cu.ft or M ₃
16.6.12.4.2.5	Concrete Class C	Cu.ft or M ₃
16.6.12.4.2.6	Lean Concrete	Cu.ft or M ₃
16.6.12.4.2.7	Roll Pointing	Sq.ft or M ₂
16.6.12.4.2.8	Coping in Specified Cement Concrete of Specified Strength	Cu.ft or M ₃

16.6.13 Dressed Coursed Stone Masonry

16.6.13.1 Description

This Section shall consist of Dressed coursed stone masonry with mortar. Dimensions of such masonry may vary as per the Drawings or as directed by the Engineer.

16.6.13.2 Material Requirements

1. Stone Size

The individual stones shall be large and well proportioned. They shall not be less than twenty (20) nor more than fifty (50) cm in thickness. The thickness of courses, if varied, shall diminish

regularly from bottom to top of wall. The size of ring stones in arches shall be as shown on the plans.

2. Mortar

Mortar shall conform to the requirement set forth under Chapter-5 of Book-2.

16.6.13.3 Construction Requirement

16.6.13.3.1 Surface Finishes of Stone

For the purpose of this specification the surface finishes of stone are defined as follows: -

1. Smooth-finished

Having a surface in which the variations from the pitch line do not exceed decimal one five (0.15) cm.

2. Rough-finished

Having a surface in which the variations from the pitch line do not exceed one and a quarter ($1\frac{1}{4}$) cm.

3. Scrabbled

Having a surface in which the variations from the pitch line do not exceed two (2) cm.

4. Rock-faced

Having an irregular projecting face without indication of tool marks. The projections beyond the pitch line shall not exceed seven and a half ($7\frac{1}{2}$) cm and no part of the face shall recede back of the pitch line.

16.6.13.3.2 Dressing Stone

- Stones shall be dressed to exact sizes and shapes before being laid and shall be cut to lie on their natural beds with top and bottom truly parallel. Hollow beds will not be permitted. The bottom bed shall be the full size of the stone and no stone shall have an overhanging top. In rock-face construction the face side of any stone shall not present an undercut contour adjacent to its bottom axis giving a top-heavy, unstable appearance when laid.
- Beds of face stone shall be fine-finished for a depth of not less than thirty (30) cm.
- Vertical joints of face stone shall be fine-finished and full to the square for a depth of not less than fifteen (15) cm.
- Exposed surfaces of the face stone shall be given the surface finish indicated on the plans, with edges pitched to true lines and exact batter, chisel drafts four (4) cm wide shall be cut at all exterior corners. Face stone forming the starling or nosing of piers shall be rough-finished unless otherwise specified.
- Holes for stone hooks shall not be permitted to show in exposed surfaces.

16.6.13.3.3 Stretchers

Stretchers shall have a width of bed of not less than one and a half (1 1/2) times their thickness. They shall have a length of bed not less than twice nor more than three and a half (3 1/2) times their thickness and not less than ninety (90) cm.

16.6.13.3.4 Headers

Headers shall be placed in each course and shall have a width of not less than one and a half (1 1/2) times their thickness. In walls having a thickness of one and two-tenths (1.2) m or less, the headers shall extend entirely through the wall. In walls of greater thickness, the length of headers shall be not less than two and a half (2 1/2) times their thickness when the course is forty-five (45) cm or less in height and not less than one and two-tenths (1.2) m in courses of greater height. Headers shall bond with the core or backing not less than thirty (30) cm. Headers shall hold in the heart of the wall the same size shown in the face and shall be spaced not further apart than two and a half (2 1/2) m center to center. There shall be at least one header to every two stretchers.

16.6.13.3.5 Cores and Backing

- Cores and backing shall consist either of roughly bedded and jointed headers and stretchers, as specified above, or concrete, as may be specified.
- When stone is used for cores or backing, at least one-half (1/2) of the stone, shall be of the same size and character as the face stone and with parallel ends. No course shall be less than twenty (20) cm thick.
- Concrete used for cores and backing shall conform to the requirements.
- The headers and stretchers in walls having a thickness of one meter or less shall have a width or length equal to the full thickness of the wall. No backing will be allowed.

16.6.13.3.6 Mixing Mortar

The mortar shall be hand or machine mixed, as may be required by the Engineer. In the preparation of hand-mixed mortar, the sand and cement shall be thoroughly mixed together in a clean, tight mortar box until the mixture is of uniform color, after which clean water shall be added in such quantity as to form a stiff plastic mass. Machine-mixed mortar shall be prepared in an approved mixer and shall be mixed not less than one and a half (1 1/2) minutes. Mortar shall be used within forty-five (45) minutes after mixing. Retempering of mortar will not be permitted.

16.6.13.3.7 Laying Stone

1. General

Stone masonry shall not be constructed in freezing weather or when the stone contains frost, except by written permission of the Engineer and subject to such conditions as he may require. Stone masonry in Cement mortar shall be cured for a minimum period of seven (7) days.

2. Face Stone

- Stone shall not be dropped upon, or slid over the wall, nor will hammering, rolling, or turning of stones on the wall be allowed. They shall be carefully set without jarring the stone already laid and they shall be handled with a Lewis or other appliance that will not cause disfigurement.

- Each stone shall be cleaned and thoroughly saturated with water before being set and the bed, which is to receive it, shall be cleaned and well moistened. All stones shall be well bedded in freshly made mortar and settled in place with a suitable wooden maul before the setting of the mortar. Whenever possible, the face joints which cannot be so pointed shall be prepared for pointing by raking them out to a depth of five (5) cm before the mortar has set. The face surfaces of stones shall not be smeared with the mortar forced out of the joints or that used in pointing. No pinning up of stones with spawls will be permitted in beds.
- Joints and beds shall be not less than one (1) cm nor more than one and a quarter (1 1/4) cm in thickness and the thickness of the joint or bed shall be uniform throughout.
- The stone in any one course shall be placed so as to form bonds of not less than thirty (30) cm with the stones of adjoining courses. Headers shall be placed over stretchers and, in general, the headers of each course shall equally divide the spaces between the headers of adjoining courses, but no headers shall be placed over a joint and no joint shall be made over a header.

3. Stone Backing and Cores

Stone backing shall be laid in the same manner as specified above for face stone, with headers interlocking with face headers when the thickness of the wall will permit. Backing shall be laid to break joints with the face stone. Stone cores shall be laid in full mortar beds so as to bond not less than thirty (30) cm with face and backing stone and with each other. Bed joints in cores and backing shall not exceed four and a half (4 1/2) cm and vertical joints shall not exceed ten (10) cm in thickness.

4. Concrete Cores and Backing

The operations involved in the handling and placing of concrete used in cores and backing shall conform to the requirements specified in 'Concrete'. However, the puddling and compacting of concrete adjacent to the ashlar masonry facing shall be done in a manner that will ensure the filling of all spaces around the stones and secure full contact and efficient bond with all stone surfaces.

16.6.13.3.8 Leveling Courses

- Stone cores and backing shall be carried up to the approximate level of the face course before the succeeding course is started.
- The construction joints produced in concrete cores or backing by the intermittent placing of concrete shall be located, in general, not less than fifteen (15) cm below the top bed of any course of masonry.

16.6.13.3.9 Resetting

In case any stone is moved or the joint broken, the stone shall be taken up, the mortar thoroughly cleaned from bed and joints and the stone reset in fresh mortar.

16.6.13.3.10 Dowels and Cramps

- Where required, coping stone, stone in the wings of abutments and stone in piers shall be secured with wrought-iron cramps or dowels as indicated on the plans.
- Dowel holes shall be drilled through each stone before the stone is placed and, after it is in place, such dowel holes shall be extended by drilling into the underlying course not less than fifteen (15) cm.

- Cramps shall be of the shapes and dimensions shown on the plans or approved by the Engineer. They shall be inset in the stone so as to be flush with the surfaces.
- Cramps and dowels shall be set in lead. Care being taken to completely fill the surrounding spaces with the molten metal.

16.6.13.3.11 Copings

- Stones for copings of wall, pier and abutment bridge seats shall be carefully selected and fully dimensioned stones. On piers, not more than two stones shall be used to make up the entire width of coping. The copings of abutment bridge seats shall be of sufficient width to extend at least ten (10) cm under the back-wall. Each step forming the coping of wingwall shall be formed by a single stone, which shall overlap the stone forming the step immediately below it at least thirty (30) cm.
- Tops of copings shall be given a bevel cut at least five (5) cm wide and beds, bevel cuts and tops shall be fine-finished. The vertical joints shall be smooth-finished and the coping shall be laid with joints not more than six-tenths (0.6) cm in thickness. The undersides of projecting copings, preferably, shall have a drip bead.
- Joints in copings shall be located so as to provide not less than a thirty (30) cm bond with the stones of the under course and so that no joint will come directly under the superstructure masonry plates.

16.6.13.3.12 Arches

- The number of courses and the depth of voussoirs shall be as shown on the plans. Voussoirs shall be placed in the order indicated, shall be full size throughout, dressed true to template and shall have bond not less than the thickness of the stone. Beds and joints shall be fine-finished and mortar joints shall not exceed two (2) cm in thickness. Exposed surfaces of the intrados and arch ring shall be given the surface finish indicated on the plans.
- Backing may consist of concrete as specified or of large stones shaped to fit the arch, bonded to the spandrels and laid in full beds of mortar. The extrados and interior faces of the spandrel walls shall be given a finishing coat of one ratio three (1:3) cement sand mortar that shall be trowled smooth to receive the waterproofing.
- Arch centering, waterproofing, drainage and filling shall be as specified for concrete arches.

16.6.13.3.13 Pointing

- Pointing shall not be done in freezing weather nor when the stone contains frost.
- Joints not pointed at the time the stone is laid shall be thoroughly wet with clean water and filled with mortar after proper raking. The mortar shall be well driven into the joints and finished with an approved pointing tool. The wall shall be kept wet while pointing is being done and in hot or dry weather the pointed masonry shall be protected from the sun and kept wet for a period of at least three (3) days after completion.
- After the pointing is completed and the mortar set, the wall shall be thoroughly cleaned and left in a neat and workmanlike condition.

16.6.13.4 Measurement and Payment

16.6.13.4.1 Measurement

- The quantity of stone masonry to be paid shall be the number of cubic meters measured in the completed work and the limiting dimensions shall not exceed than those shown on the Drawings or fixed by the Engineer.
- Concrete Class C or lean shall be measured separately as per dimensions shown on the Drawings or as directed by the Engineer, No separate measurement shall be made for stuck pointing, which is deemed to be included in stone masonry with mortar, however roll pointing shall be measured separately in square meters. No separate measurement will be made for dowels and cramps.

16.6.13.4.2 Payment

The accepted quantities measured as provided above shall be paid for at the Contract unit price respectively for the pay items listed below and shown in the Bill of Quantities, which price and payment shall constitute full compensation for labor, materials, tools, equipment, dowels, cramps and incidentals necessary to complete the work prescribed in this Section: -

Pay Item No.	Description	Unit of Measurement
16.6.13.4.2.1	Stone Masonry Dressed Coursed with Cement Sand Mortar of Specified Mix	Cu.ft or M ₃
16.6.13.4.2.2	Concrete Class C	Cu.ft or M ₃
16.6.13.4.2.3	Lean Concrete	Cu.ft or M ₃
16.6.13.4.2.4	Roll Pointing	Sq.ft or M ₂
16.6.13.4.2.5	Coping in Specified Cement Concrete of Specified Strength	Cu.ft or M ₃
16.6.13.4.2.6	Stone Masonry in Arches	Cu.ft or M ₃

16.7 Drainage and Erosion Works

16.7.1 General

The Contractor shall so schedule the construction of drainage works that the discharge of runoff from rain or other sources, both during and after construction, is properly provided for. To avoid damage to works in course of construction, the Contractor shall provide adequate means of protection, including all necessary temporary outlet ditches, dams or diversion channels, culverts, ditches or other drainage works for the discharge of runoff water during construction and which shall be kept clear of all obstructions that might impede the flow of water. These requirements shall be met without additional payment and all costs thereof shall be included in the bid prices for any items under the contract. Drainage structures shown on the Drawings and their estimated total quantities are not to be taken as final. The Engineer, who will inform the Contractor of them in writing, will decide the final quantities.

16.7.2 Reinforced Concrete Pipe Culverts

16.7.2.1 Description

This work shall consist of the construction, reconstruction or repair of culverts and water drainage structures in accordance with these specifications, and in conformity with the lines, grades and dimensions shown on the Drawings or as ordered by the Engineer. The work shall include the furnishing and laying of the pipe and the construction of such joint connection to oilier pipes, catch basins, or other structures as may be required to complete the work as shown on the Drawings or as required by the Engineer. The work shall also include the removal and disposal of existing culverts and structures except such portions as may be required or permitted by the Engineer to be left in place. The Engineer reserves the right to inspect and test the pipe after its delivery to the work. Injurious defects revealed subsequent to acceptance of pipe and prior to its installation in the work shall be cause for rejection. The Contractor shall not order and deliver the pipes for any work until the Engineer has approved a list of sizes and lengths.

16.7.2.2 Material Requirements

- The pipes shall meet the requirements of the AASHTO M-170 class II and IV as called for in the Bill of Quantities.
- Cement, sand and water shall conform to the requirements specified of Concrete, except that the grading of sand shall meet the requirements of AASHTO M-45.
- Steel reinforcement shall conform to the requirements specified in 'steel structures' of these specifications.
- Rubber ring gaskets for rigid pipe, if required shall conform to the requirements of AASHTO M-198.

16.7.2.3 Manufacturing Requirement

Reinforced concrete pipe culverts shall conform to the requirements of AASHTO M-170.

1. Dimension and Strength Test Requirement

Shell thickness, the quantity of circular reinforcement and the strength per linear, meter, for the various sizes of pipe shall conform to the minimum requirements listed in related tables per AASHTO M-170.

2. Reinforcement

Each line of reinforcement shall be assembled into a cage, which shall contain sufficient longitudinal bars or members extending through the barrel of the pipe to, maintain the reinforcement rigidly in exact shape and correct position within the form. If the splices are not welded, the reinforcement shall be lapped not less than 30 diameters for bars and 40 diameters for cold drawn wire. If welded, the member at either a welded splice or intersection shall develop a tensile strength, not less than three thousand and seven hundred-(3700) Kgf/Sq.cm. The spacing centers of adjacent rings of the circumferential reinforcement (pitch) shall not exceed 10 cm/2". The circumferential reinforcement shall be located midway between the inner and outer surfaces of the pipe within a tolerance of \pm six (6) mm/1/4".

3. Joints

The ends of reinforced concrete culvert pipes shall be the ogee or spigot and socket types and of such design that when laid the joints shall form a continuous conduit with a smooth and uniform interior surface.

4. Tolerances

Variations in internal diameter and wall thickness shall not exceed the limit specified in relevant "Table for Allowable Tolerances" for reinforced concrete pipes in these Specifications.

5. Absorption

The water absorption of the concrete pipe shall not exceed eight (8) per cent of the dry weight as determined in AASHTO designation T-33.

6. Curing

Pipes shall be subjected to any one of the' methods of curing described in the following paragraphs or to any other method or combination of methods, approved by the Engineer's Representative, that will give satisfactory results, provided that no pipe shall be used within a period of fourteen (14) days after curing. All pipes shall be marked with the date of casting.

1. Steam Curing

Pipes shall be placed in a curing chamber, free from outside draughts, and cured in a moist atmosphere, maintained at a temperature between thirty eight (38°) and fifty-four (54°) degree C by the injection of steam for a period of not less than twenty-four (24) hours or, when necessary, for such additional time as may be needed to enable the pipe to meet the strength requirements. When a curing chamber is not available, pipes may be placed in an enclosure of canvas or other closely woven material and subjected to saturated steam at the temperature and for the time specified above. "The enclosure shall be so erected as to allow full circulation of steam around the entire pipe. The interior surfaces of the curing room or canvas jackets and the surfaces of the pipes shall be entirely moist at all times.

2. Water Spray Curing

Under the conditions of enclosure prescribed in (i) above, pipes may be cured by subjecting them to a continuous or frequently applied fine spray of water in an enclosure maintained at a temperature of not less than twenty-one (21°) degree C for a period of not less than seventy-

two (72) hours, or such additional time as may be necessary to meet the strength requirements.

3. Saturated Cover Curing

The sides and top of each pipe may be covered with heavy Hessian or other suitable material, saturated with water before applying and kept saturated with water at a temperature of not less than twenty-one (21°) degree C for seventy-two (72) hours, or such additional time as may be necessary to meet the strength requirements. The ends of the pipes shall be so enclosed as to prevent the free circulation of air through or around the pipe. If the temperature of the water is less than twenty-one (21°) degree C, the curing period shall be increased as may be necessary to meet the strength requirements. The ends of the pipes shall be so enclosed as to prevent the free circulation of air through or around the pipe.

7. Workmanship and Finish

All pipes shall be substantially free from fractures, large or deep cracks, honeycombing, open texture; spells and surface roughness. The planes of the ends of the pipe shall be perpendicular to the longitudinal axis.

8. Inspection

The quality of all materials, the process of manufacture and the finished pipes shall be subject to inspection, test and approval at the place of manufacture. The Contractor shall make the necessary arrangements with the manufacturer to set aside in a separate area all pipes for which he desires approval.

1. Test Specimens

Pipes for the purpose of tests shall be furnished free of cost by the Contractor and will be selected at random by the Engineer. The numbers of sections are required for test will not be more than two (2) percent except that at least one of every size will be selected. Pipes for tests shall conform to these specifications.

2. Test Equipment

If the manufacturer has equipment for conducting the crushing strength test, the Contractor shall make the necessary arrangements to have the required tests conducted in the presence of the Inspector designated by the Engineer. If the testing facilities are not available at the point of manufacture, the Contractor shall make the necessary arrangements for furnishing & testing at no cost to the Employer, the pipe sections selected by the Inspector to a laboratory approved by the Engineer.

3. Re-test

Should any of the test specimens provided in accordance with the requirements listed in paragraph (1) above fail to meet the test requirements, the Contractor will be allowed a retest on two additional specimens for each specimen that failed, and the pipe will be acceptable only when all these retested specimens meet the strength requirements.

9. Rejection

Pipes shall be subject to rejection on account of failure to conform to any of the above specification requirements or on account of any of the following: -

- Fractures or cracks passing through the shell, except that a single end crack that does not exceed the depth of the joint shall not be cause for rejection. If a single end crack that does not exceed the depth of the joints exists in more than ten (10) per cent of the pipes inspected, however, the defective pipes shall be rejected.
- Defects that indicate imperfect mixing and moulding.
- Surface defects indicating honeycombing or open texture and exposure of reinforcement including rust marks caused by inadequate concrete cover.
- Spalls deeper than one half the depth of the joint or extending more than ten (10) cm/4” around the circumference. If spalls not deeper than one half of the joint or extending not more than ten (10) cm/4” around the circumference exist in more than ten (10) per cent of the pipes, however the defective pipes shall be rejected.
- Misplaced reinforcement already disposed or verified by checking with an approved concrete reinforcement cover meter.

16.7.2.4 Construction Requirement

16.7.2.4.1 Excavation

- A trench shall be excavated to the depth and grade established by the Drawings. The bottom of the trench shall be shaped to conform to the shape of the pipe for at least twenty (20) percent of its outside diameter. The width of the trench shall of be greater than two (2) times the pipe diameter, to permit satisfactory jointing and thorough tamping of the bedding material specified in Section 9-3 under and around the pipe. Recesses shall be excavated for any bells involved. Where rock or hardpan is encountered, the trench shall be excavated to a depth at least (30) centimeters/12” below the grade established for the bottom of the pipe. This excess depth shall be refilled with approved material and thoroughly compacted.
- Where in the opinion of the Engineer, the natural foundation soil is such as to require stabilization, such material shall be replaced by a layer of suitable material. Where an unsuitable material (peat, mulch, etc.) is encountered at or below invert elevation during excavation, the necessary subsurface exploration and analysis shall be made and corrective treatment shall be as directed by the Engineer. Measurement & Payment will be made and paid accordingly to the relevant section of the specifications of Roads and Bridges Construction.

16.7.2.4.2 Placing Pipe

The pipe shall be laid carefully, bell up grade, ends fully and closely jointed, and true to the elevations and grades given. Proper facilities shall be provided for lowering the sections when they are to be placed in a trench. Each section shall be securely attached to the adjoining sections by the method specified for the type of joint used. All joints, unless otherwise specified, shall be filled with stiff mortar composed of one-part Portland cement and two parts sand. The mortar shall be placed so as to form a durable, watertight joint around the whole circumference of the pipe. After each section of pipe is laid and before the succeeding section is laid the lower portion of the bell shall be plastered thoroughly on the inside with mortar to such depth as to bring the inner surface of the abutting pipe flush and even. After the section is laid, the remainder of the joint shall be filled with mortar and sufficient additional mortar shall be used to form a bead around the outside of the joint. The inside of the joint shall then be wiped and finished smooth. After the initial set, the mortar on the outside shall be protected from the air and sun with a cover of thoroughly wetted earth or burlap. Any pipe, which is not

true in alignment or which shows any undue settlement after being laid, or is damaged, shall be taken up and re-laid or replaced without extra payment. All joints, including any connections; shall be capable of transferring the required shear across the point.

16.7.2.4.3 Backfilling

After the pipe has been installed and the mortar joints sufficiently set, granular material (sand) and or selected material from roadway excavation or borrow shall be placed alongside the pipes in layers not exceeding twenty (20) cm in depth and compacted to minimum ninety (90%) percent of the maximum dry density determined as per AASHTO T-191 Method, so that on each side of the pipe there shall be thoroughly, compacted material at least as wide as the external diameter of the pipe except insofar as undisturbed material obtrudes upon this width. Each layer shall be moistened, if dry and then compacted by tamping with mechanical hammers or by hand tamping with heavy iron tampers to the densities as specified under Section 4-6 "*Formation of Embankment*". This method of filling and compacting shall be continued until the embankment has reached an elevation of twenty (20) cm/8" above the top of the pipe. When construction calls for placing a high embankment over the pipes, special instructions regarding the method of back filling shall be given by the Engineer. Measurement & Payment will be made and paid accordingly to the relevant section of the specifications of Roads and Bridges Construction.

16.7.2.4.4 Construction Plant

Movement of Construction equipment, over a culvert shall be at the Contractor's risk. Any pipe injured thereby shall be repaired or placed at the contractor's cost.

16.7.2.4.5 Headwalls

Where indicated on the Drawings, the ends of the pipe culverts shall be protected by concrete or masonry headwalls constructed as shown on the Drawings. When headwalls are constructed, the ends of the pipe shall be neatly cutoff flush with the outside face of the headwalls.

16.7.2.5 Measurement and Payment

16.7.2.5.1 Measurement

The quantities to be paid for shall be the number of linear meters/RFT of pipe placed completed and accepted. Payment shall be made separately under 16.7.3 for furnishing and installing granular material or concrete in the bed of the culvert as shown on the Drawings.

16.7.2.5.2 Payment

The quantities as measured above shall be paid for at the contract unit price respectively, for each of the particular pay items listed below in the B.O.Q. Payment shall be full compensation for furnishing and placing all materials including mortar for joints, for excavating trenches and backfilling, and. for all other costs necessary or usual to the proper completion of the work prescribed in this Section. Headwalls, wing walls and aprons together with the bedding for the concrete pipe culvert: will be measured and paid for separately.

Pay Item No.	Description	Unit of Measurement
AASHTO M 170, Class II Reinforced Concrete pipe.		
16-31-a-i	Diameter 310 mm/12" inside	M/Rft
16-31-a-ii	Diameter 380 mm/15" inside	M/Rft
16-31-a-iii	Diameter 460 mm/18" inside	M/Rft
16-31-b-i	Diameter 610 mm/24" inside	M/Rft
16-31-c-i	Diameter 760 mm/30" inside	M/Rft
16-31-d-i	Diameter 910 mm/36" inside	M/Rft
16-31-e-i	Diameter 1070 mm/42" inside	M/Rft
16-31-f-i	Diameter 1220 mm/48" inside	M/Rft
16-31-g-i	Diameter 1520 mm/60" inside	M/Rft
AASHTO M 170, Class IV Reinforced Concrete pipe		
16.7.2.5.2	Diameter 310 mm/12" inside	M/Rft
16.7.2.5.2	Diameter 380 mm/15" inside	M/Rft
16.7.2.5.2	Diameter 460 mm/18" inside	M/Rft
16.7.2.5.2	Diameter 610 mm/24" inside	M/Rft
16.7.2.5.2	Diameter 760 mm/30" inside	M/Rft
16.7.2.5.2	Diameter 910 mm/36" inside	M/Rft
16.7.2.5.2	Diameter 1070 mm/42" inside	M/Rft
16.7.2.5.2	Diameter 1220 mm/48" inside	M/Rft
16.7.2.5.2	Diameter 1520 mm/60" inside	M/Rft

16.7.3 Bedding or Encasement of Concrete Pipe Culverts

16.7.3.1 Description

This work shall consist of furnishing and placing granular material or concrete as specified for bedding concrete pipe culverts or encasement.

16.7.3.2 Material Requirements

16.7.3.2.1 Granular Material

Granular material shall be sand or selected sandy soil all of which passes a 9.5 mm (3/8-inch) sieve and not more than fifteen (15) percent passes No 200 sieve.

16.7.3.2.2 Concrete

Concrete class B shall be used as specified under 'concrete' unless otherwise specified on the drawings or as directed by the Engineer.

16.7.3.3 Construction Requirement

- The bedding material consisting of granular material as specified in 16.7.3.2.1 shall be laid to the dimensions shown on the drawings. The top surface shall be accurately shaped by template to fit the surface of the concrete pipe culvert for at least twenty (20) percent of its outside diameter.
- Granular material shall be deposited in layers not exceeding fifteen (15) cm (6 inches) and shall be compacted to at least ninety-five (95) percent maximum dry density in accordance with AASHTO T 180, Method D or at least seventy-four (74) percent relative density in accordance with ASTM D 2049, whichever is applicable.

- Concrete class B if shown on the drawings shall be mixed placed finished and cured all in accordance with 'Concrete'.

16.7.3.4 Measurement and Payment

16.7.3.4.1 Measurement

The quantities to be paid for shall be the number of cubic meters of granular material, or concrete class B, placed and accepted.

16.7.3.4.2 Payment

The quantities measured as provided above shall be paid for at the contract unit price, for each of the particular pay items listed below, which prices and payment shall be full compensation for furnishing and placing all materials included for completion of the work prescribed in this Section. Payment shall be made under: -

Pay Item No.	Description	Unit of Measurement
16-32-b	Granular Materials in Bed to Concrete Pipe Culvert	Per cubic meter (m3) 100 cft.
16-33	Concrete class B in Bedding and Encasement of Concrete Pipe Culvert.	Per cubic meter (m3) 100 cft.

16.7.4 Under Drain

16.7.4.1 Description

The work shall consist of furnishing and installing under drains complete in accordance with these specifications and as shown in the Drawings.

16.7.4.2 Material Requirements

16.7.4.2.1 Perforated Concrete Pipe

This pipe shall conform to the requirements of AASHTO M 175 or to ASTM C-444 for the specified diameters and strength classes.

16.7.4.2.2 Porous Concrete Pipe

This pipe shall conform to the requirements of AASHTO M 176 for the specified diameters.

16.7.4.2.3 Granular Backfill

Granular backfill for bedding and surrounding under drains shall be aggregate conforming to the requirements of Granular Sub base Grading C. In order to avoid intrusion into the sub base of the in place surrounding earth material, it shall be required that the ratio: -

$$\frac{D_{15} \text{ (Subbase)}}{D_{85} \text{ (Surrounding Earth)}} = \text{Less than } 5$$

16.7.4.3 Construction Requirement**16.7.4.3.1 Trench and Bedding**

Trenches shall be excavated to the width, line and grade as shown in the Drawings, unless shown other-wise on the Drawings, the depth shall vary from 0.7 to 1.4 meters below the bottom of a gutter or ditch when under drain is sited under a gutter or ditch, and to depths required for proper drainage, as determined by the Engineer In charge. A bed of granular back-fill, ten (10) cm (4inch) thick, shall be spread, and compacted in the bottom of the trench throughout its entire length.

16.7.4.3.2 Placing Pipe and Backfilling

- The pipe shall be embedded firmly material, bells upgrade, ends fully entered in the adjacent bells and spot mortared to provide for centering of the pipe, but the joint shall not be closed to the desired infiltration of water Perforated pipe shall be laid with the perforated length of the pipe on its underside.
- After the pipe has been placed and approved by the Engineer, granular backfill as specified above shall be placed around the drain for a thickness of at least thirty (30) cm (12inch) and care shall be taken that no pipe is displaced. The upper portion of the trench shall then be filled with approved fine soil selected from structural, common or borrow excavation. All filling material shall be thoroughly compacted, to the satisfaction of the Engineer.

16.7.4.4 Measurement and Payment**16.7.4.4.1 Measurement**

The quantities to be paid for shall be: -

- The number of meters of under drain, of the kind mentioned below, in place and accepted.
- The number of cubic meters (cubic foot) of granular backfill, in place, and accepted.

16.7.4.4.2 Payment

The quantities, determined as provided above, shall be paid for at the contact unit price for the pay items lists below. These prices and payment shall be full compensation for furnishing and placing the under drain, for excavating the trench in which the under drain is laid for granular backfill used, for the backfill and all other costs related to the work prescribed in this Section.

Pay Item No.	Description	Unit of Measurement
16.7.4.4.2.1	Perforated Concrete Pipe for Under drain, Diameter 150 mm	M/Rft
16.7.4.4.2.2	Perforated Concrete Pipe for Under drain, Diameter 200 mm	M/Rft
16.7.4.4.2.3	Perforated Concrete Pipe for Under drain, Diameter 380 mm	M/Rft
16.7.4.4.2.4	Porous Concrete Pipe for Under drain, Diameter 150 mm	M/Rft
16.7.4.4.2.5	Porous Concrete Pipe for	M/Rft

	Under drain, Diameter 200 mm	
16.7.4.4.2.6	Granular Backfill to Concrete Pipe under drain.	M ₃ /100Sft

16.7.5 Headwalls, Wingwalls, Parapets Approach Slabs, and Aprons

16.7.5.1 Description

This work shall consist of construction of sections as mentioned in the Section above in concrete, brickwork or stone work for concrete pipe and other culverts and bridges shown on the Drawings.

16.7.5.2 Material Requirements

16.7.5.2.1 Steel Reinforcement

Quality of Steel reinforcement shall be in accordance with the material requirements of 'steel structures' of these specifications.

16.7.5.2.2 Concrete

Quality requirements of all materials for Concrete of Class A, Class B, Class C or Lean Concrete as specified on the Drawings and shall be in accordance with the material requirements of 'concrete', of these specifications.

16.7.5.2.3 Brickwork

Quality of brick and other materials shall be in accordance with the requirements of 'Brick Masonry' of these specifications.

16.7.5.2.4 Stone Work

Stone work shall be in conformity with 'Random and dressed uncoursed stone masonry' and 'stone for masonry'.

16.7.5.3 Construction Requirement

16.7.5.3.1 Excavation

Excavation shall be in accordance with 'Structural Excavation and Backfill' and in conformity with the Drawings.

16.7.5.3.2 Granular Backfill

Granular backfill, if ordered in writing by the Engineer, shall be furnished, placed and compacted in accordance with 'Structural Excavation and Backfill'

16.7.5.3.3 Formwork

Formwork shall be supplied and fixed in the positions required for the concrete to be cast as shown on the Drawings and shall be erected and removed as directed by the Engineer.

16.7.5.3.4 Steel Reinforcement

Steel reinforcement shall be furnished, bend and fixed as shown on the Drawings. Bending and fixing shall be in accordance with 'Steel Reinforcement'.

16.7.5.3.5 Concrete

Concrete Class A, B, C or Y shown on the Drawings shall be placed, finished and cured, as specified in Standard Specifications for Road and Bridge Construction.

16.7.5.3.6 Brickwork

Brickwork as shown on the drawings shall be carried out as specified in 'Brick Masonry'.

16.7.5.3.7 Stone Work

Stone work shall be in conformity with 'Random and dressed uncoursed stone masonry', 'Dressed Coursed Stone Masonry' and 'Stone for Masonry'.

16.7.5.4 Measurement and Payment

- The formwork in place and accepted shall not be measured for payment and shall be deemed to have been paid under other items.
- Steel reinforcement in place and accepted shall be measured and paid for as specified in 'Steel Reinforcement', Standard Specifications for Road and Bridge Construction.
- Concrete in place and accepted shall be measured and paid for as specified in 'Concrete', Standard Specifications for Road and Bridge Construction.
- Granular backfill in place and accepted shall be measured and paid for as specified in 'Structural Excavation and Backfill', Standard Specifications for Road and Bridge Construction.
- Brickwork in place and accepted shall be measured and paid as specified in 'Brick Masonry', Standard Specifications for Road and Bridge Construction.
- Stonework in place and accepted shall be measured and paid as specified in 'Random and dressed uncoursed stone masonry', 'Dressed Coursed Stone Masonry' Standard Specifications for Road and Bridge Construction.

16.7.6 Manholes

16.7.6.1 Description

This work shall consist of the furnishing and erecting pre-cast or cast in situ concrete manholes of sizes shown in drawings with the necessary frames and covers constructed in accordance these specifications and the specifications for the other work items involved and in conformity with the dimensions, lines, elevations and design shown on the drawings.

16.7.6.2 Material Requirements

16.7.6.2.1 Pre-cast/Cast in Situ Concrete Units

- These units shall be cast to the dimensions shown on the drawings. Cement concrete shall be Class A2 in accordance with 'Concrete'. Reinforcement shall be used as per

drawings. The pre-case units shall be cured in accordance with AASHTO M170. Water absorption of individual cores taken from such unit shall not exceed seven (7) percent.

- A sufficient number of cylinders/cubes shall be cast to permit compression tests at seven (7) and twenty-eight (28) days, to allow for at least two cylinders for each test. If the strength requirement is met at seven (7) days, the units will be certified for use after fourteen (14) days from date of casting. If the strength requirement is not met at twenty-eight (28) days, all units made from that batch will be rejected.
- Cracks in units, honeycombed or patched areas in excess of 200 sq. cm (30 sq. inches), excessive water absorption and failure to meet strength requirements will be cause for rejection.

16.7.6.2.2 Steel Reinforcement

Steel reinforcement shall be in accordance with the requirements of 'Steel Structures'.

16.7.6.2.3 Frames, Grates and Covers, and Ladder Rungs

- Metal units shall conform to the dimensions shown on the drawings and to the following requirements for the designated materials.
- Gray iron castings shall conform to the requirement of AASHTO M 105. Strength class shall be optional unless other-wise specified.
- Carbon steel casting shall conform to the requirements of AASHTO M 103. Grade shall be optional unless otherwise specified.
- Structural steel shall conform to the requirements of AASHTO M 193 or ASTM A 283, Grade B or better.
- Galvanizing where specified for these units, shall conform to the requirements of AASHTO M 111.
- Malleable iron castings shall conform to the requirements of AASHTO M 106. Grade shall be optional unless otherwise specified.

16.7.6.2.4 Mortar

Mortar shall be composed of one-part Portland cement and two parts of fine aggregate conforming to 'Mortar' by volume unless otherwise specified and sufficient water to make the mortar of such consistency that it can be handled easily and spread with a trowel.

16.7.6.2.5 Concrete

In case of cast in situ concrete manholes, Concrete shall be of Class A unless otherwise shown on the drawings or as directed by the Engineer, and shall conform to the requirements prescribed under 'Concrete'. Forms of approved quality shall be used to give reasonable fair finish from inside, while rough form work may be allowed for outside finish. All other specifications shall be followed as per specifications given in 'Concrete'.

16.7.6.3 Construction Requirement

16.7.6.3.1 Excavation

Excavation shall conform to the requirement of 'Structural Excavation and Backfill'.

16.7.6.3.2 Backfill

Backfill shall conform to the requirements of 'Structural Excavation and Backfill', unless where granular backfill as specified under 'Structural Excavation and Backfill' is required by the drawings, or is specified in writing by the Engineer.

16.7.6.3.3 Steel Reinforcement

Reinforcing Steel shall conform to the requirements of steel reinforcement in chapter 6 of these specifications.

16.7.6.3.4 Concrete

Cement Concrete shall conform to the requirements of chapter 6 of these specifications.

16.7.6.3.5 Pre-cast Concrete Units

- Pre-cast concrete units shall be erected in positions shown on the drawings, or as directed by the Engineer.
- During erection of the units the outside of manhole shall be finished smooth and the joints flushed full with the mortar.

16.7.6.3.6 Connections

Sections of connections pipe shall be incorporated in to the construction and placed at the elevation, direction and grade required. The inner ends of the pipes shall be flush with the inner faces of the walls.

16.7.6.3.7 Metal Frames

Metal frames shall be set on full mortar beds of otherwise secured as shown on the drawings and the frames, covers, and gratings shall be accurately set true to the line and elevation required to fit the adjoining surface as approved by the Engineer.

16.7.6.3.8 Cleaning

Upon completion each manhole shall be thoroughly cleaned by any accumulations of silt debris, or foreign matter of any kind and shall be kept clean of such accumulations until final acceptance of the work.

16.7.6.4 Measurement and Payment

16.7.6.4.1 Measurement

The quantities to be paid for shall be: -

- The number of concrete manholes, complete with frames and covers and all other relevant components in position and accepted, from one (1) meter to two (2) meters deep/6-1/2 feet.
- The number of concrete manholes, complete with frames and covers and all other relevant components in position and accepted, more than two (2) meter and up to three (3) meters deep/10 feet.

- The number of concrete manholes, complete with frames and covers and all other relevant components in position and accepted, greater than three (3) meters in depth//10 feet.

In the determination of the depth of a manhole the distance shall be measured from the top surface of the manhole cover to the under surface of the foundation of the manhole.

16.7.6.4.2 Payment

The quantities measured as provided above shall be paid for at the contract unit price respectively, for each item listed below and as given in the Bill of Quantities, which prices and payment shall be full compensation for furnishing and placing all materials, and for all other costs necessary for the satisfactory completion of work prescribed in this section. Excavation & granular back fill shall be paid under 'Structural Excavation and Backfill' Payment shall be made under: -

Pay Item No.	Description	Unit of Measurement
16.7.6.4.2.1	Concrete manhole 1 m to 2 m/ 3'-3" to 6'-6" deep	Each
16.7.6.4.2.2	Concrete manhole more than 2 m to 3 m/ 6'-6" to 10' deep	Each
16.7.6.4.2.3	Concrete manhole more than 3 m/ 10' deep	Each

16.7.7 Drop Inlets and Catch Basins

16.7.7.1 Description

The work shall consist of constructing concrete catch basins, and drop inlets including the furnishing of metal frames, grates and lids, and the necessary excavation and backfill in accordance with these specifications and the specifications for other work items involved and in conformity with the dimensions, elevations and design shown on the Drawings.

16.7.7.2 Material Requirements

16.7.7.2.1 Steel Frames, Grates and Lids

Steel frames, grates and lids shall conform to the requirements of AASHTO M-105.

16.7.7.2.2 Concrete

Concrete shall be as specified in specifications.

16.7.7.2.3 Masonry

When so indicated on the plans or approved by the Engineer, brick or concrete block masonry may be used in lieu of concrete for the walls of catch basins or drop inlets as specified in "Brick Masonry".

16.7.7.2.4 Steel Reinforcement

Quality of reinforcing steel if used in construction of catch basins shall be in accordance with the material requirements of 'Steel Reinforcement'.

16.7.7.3 Construction Requirement

16.7.7.3.1 Excavation and Backfill

Excavation and backfill shall conform to the requirements of 'Structural Excavation and Backfill' as the case may be.

16.7.7.3.2 Concrete Construction

Concrete of the specified class shall be supplied, placed finished and cured as specified in 'Concrete'.

16.7.7.3.3 Connections

Inlet and outlet tile, sewer pipe and conduit for connections with such structures shall be of the same size, type and class as the tile, sewer pipe, and conduit with which connections are made and shall conform to the pertinent requirements thereof. Pipe placed in cement concrete for inlet or outlet connections shall extend from the inside surface of the wall and beyond the outside surface of the walls a minimum distance of forty-five (45) centimeters/18" distance to allow for connections with conduits or sewers, and the concrete shall be carefully constructed around them so as to prevent leakage around their outer surface.

16.7.7.3.4 Frames, Grates and Lids

- All frames shall be set on full mortar beds or otherwise secured as shown on the drawings. Grates and lids shall be fitted or secured to the frames so that rocking is eliminated.
- The frames, grates and lids shall be accurately set so that the complete installation will be at the correct elevation required to fit the adjoining surfaces, the grates and lids shall not be in place while the adjoining concrete is struck-off and finished.

16.7.7.3.5 Cleaning

All catch basins and drop inlets shall be thoroughly cleaned of any accumulations of silt, debris, or foreign matter of any kind, and shall be kept clear of such accumulations until the final acceptance of the work.

16.7.7.4 Measurement and Payment

16.7.7.4.1 Measurement

The quantities to be measured shall be: -

- The number of drop inlets of the type specified in the construction of Drop inlets, complete in place and accepted.
- The numbers of catch basins of the type specified complete in place and accepted.

16.7.7.4.2 Payment

The quantities measured as provided above shall be paid at the contract unit price for each of the pay items listed below. Such prices and payment shall be full compensation for furnishing and placing all materials, and for all other cost's relative to the proper completion of the work prescribed. Granular backfill in place and accepted shall be measured and paid for as specified in 'Structural Excavation and Backfill'.

Pay Item No.	Description	Unit of Measurement
16.7.7.4.2.1	Excavation	Per m ³ /100 cft.
16.7.7.4.2.2	Masonry	Per m ³ /100 cft.
16.7.7.4.2.3	Concrete	Per m ³ /100 cft.
16.7.7.4.2.4	Steel Reinforcement	Per Kg. /Per lb.
16.7.7.4.2.5	Steel Frames, Grates	Per Kg/Per lb.

16.7.8 Gabions

16.7.8.1 Description

This work shall consist of wire-mesh gabions, furnished and placed in accordance with these specifications, and the specifications for the other work items involved, and at the locations and in conformity with lines and grades shown on the drawings or as directed by the Engineer. The work in general, covers gabions used for construction of retaining & breast walls and stream stabilization works.

16.7.8.2 Material Requirements

16.7.8.2.1 General

Gabions shall be enclosed by galvanized steel wire mesh, which shall be supplied folded flat to facilitate transport and handling. Gabions shall be furnished in accordance with the various lengths and heights required by the drawings, or as directed by the Engineer. If not otherwise required, all gabions shall be one meter (3.3 feet) in width. The length shall be multiples of 2,3 or 4 times the width of the gabion and heights shall be 0.33 m, 0.66 m or 1.0 m (1.1 ft, 2.2 ft, 3.3 ft).

16.7.8.2.2 Wire

- All wire shall be good commercial quality of steel and size as per drawings coated with a prime western speller or equal (AASHTO M 120)/ (ASTM A90) applied at a rate of not less than 0.8 ounces per square foot (0.25 Kg/sq. m) of uncoated wire.
- Uniformity of coating shall withstand ten (10) one-minute dips by the Preece Test in accordance with AASHTO T-66. "Uniformity of Coating by the Preece Test (Copper Sulphate Dip) on Zinc Coated (Galvanized) Iron or Steel Articles". Wire mesh shall withstand 220 hours of exposure before failure by rusting of any part when subjected to a salt spray test in accordance with ASTM B 117.
- The tensile strength of the wire shall be in the range of four thousand (4000) to six thousand (6000) kg./sq.cm. And shall have an elasticity to permit elongation of the mesh equivalent to minimum of ten (10) % without reducing the gauge or tensile strength of the wire.
- The minimum size of the wire and zinc coating used in fabrication of the gabion baskets shall be according to ASTM A641/641M, as shown in Table.

	Diameter mm	Zinc Coating (g/m ²)
Body Wire	2.7	240

Selvedge or Perimeter Wire	3.4	260
Tying and Connecting wire	2.2	210

Table 79, Minimum Size of the wire used in fabrication of Gabions Baskets

16.7.8.2.3 Fabrication

- Gabions shall be in the form of rectangular baskets of the required dimensions and shall be manufactured from wire as specified above. Gabions shall be made of steel wire triple twisted forming a uniform hexagonal mesh pattern with openings eight (8) cm (3 inches) by ten (10) cm (4 inches) or ten (10) cm by twelve (12) cm (4" x 5"). The edges shall be formed into securely connected salvages adequate to prevent raveling. Individual basket ties and connections shall be made by using a quantity of wire not less than 8 percent of the weight of each basket.
- When the gabion length exceeds its width, it shall have securely tied diaphragms connect at all edges to form individual cells of equal length and width. Diaphragms shall be of the same material and manufactured as specified above for the gabions.
- Four cross-connecting wires shall be provided in each cell having a height of one half the width or less, and eight (8) cross-connecting wires shall be provided in each cell having a height greater than one half the width.
- All the characteristics, values and figures given in the above specifications are subject to the tolerance of plus or minus five (5) percent.

16.7.8.2.4 Rock Fill

Fill for gabions shall consist of hard, durable rock pieces that will not deteriorate when submerged in water or exposed to severe weather conditions. Rock pieces shall be generally uniformly graded in sizes ranging from twelve (12) cm (5") to twenty (20) cm (8"). Filled gabions shall have a minimum density of one thousand three hundred sixty (1360) kg per cubic meter. Void spaces shall be evenly distributed and shall not exceed a maximum of thirty (30) percent. The rock shall meet the requirements of AASHTO M63 except that the Sodium Sulphate Soundness Loss shall not exceed nine (9) % after five (5) cycles.

16.7.8.3 Construction Requirement

- Installation shall be performed in a workmanlike manner as approved by the Engineer. Beds for gabions shall be suitably leveled. Gabions forming elements of structures shall be securely connected along the complete length of top contact edges by means of the above-specified tying and connection wire.
- Before the rock fill is placed the gabions shall be stretched in such manner as will permit proper shape, alignment and compaction of fill.
- Rock fill for exposed faces of gabions walls shall be carefully selected for uniformity of size, and the pieces shall be hand placed to provide a neat appearance as approved by the Engineer.
- The vertical joints of gabion baskets shall be staggered as in running bond brickwork.

16.7.8.4 Measurement and Payment

16.7.8.4.1 Measurement

The quantities shall be measured for payment as under: -

1. Wire Mesh

The galvanized steel wire mesh furnished, placed and accepted shall be the theoretical number of kilograms or pounds calculated from the weight per square meter or per square foot of mesh respectively by the manufacturer. The area of mesh to be measured shall be the net area of the gabion in position.

2. Rock Fill

The rock fill shall be the number of loose cubic meters of rock placed in the gabion with an allowance of maximum thirty (30) % voids and accepted and measured by the width, breadth and length of the gabion constructed.

16.7.8.4.2 Payment

The quantities determined as provided above shall be paid for at the contract unit price, which shall be full compensation for all necessary excavation, furnishing and placing of materials and all other costs related to completion of the work. Payment shall be made under: -

Pay Item No.	Description	Unit of Measurement
16.7.8.4.2.1	Steel Wire mesh for Gabions	Kilogram (kg)
16.7.8.4.2.2	Rock Fill in Gabions	Cubic Meter (m ³)

16.7.9 Riprap and Reinforced Concrete Slope Protection

16.7.9.1 Description

This work consists of furnishing, and placing protective covering protective resistant material as riprap or reinforced concrete slope protection on the locations shown on the plans for slopes or pier foundation protection. The work shall be done in accordance with the specifications and conformity with the lines, grades thickness and typical cross sections shown on the plans. The areas to receive riprap or slope protection of any kind shall be dressed smooth to the slopes or shapes called for on the plan and shall be free from stumps, organic matter, or waste material. A filter blanket should be provided where it is anticipated that there may be migration of fines through the riprap. Toe trench and/or filter blanket is to be constructed, as directed by the Engineer. All materials, regardless of type or kind, shall be placed as per lines and levels called for on the Drawings.

16.7.9.2 Material Requirements

16.7.9.2.1 Stones

Stone for riprap shall consist of field stone or rough uneven quarry stone as nearly rectangular in section as is practical, except that riprap of Class A shall consist of round natural stones. The stones shall be sound, tough, durable, dense, resistant to the action of air and water, and suitable in all respects for the purpose intended. Samples of the stone to be used shall be submitted to and approved by the Engineer before any stone is placed. The minimum apparent specific gravity shall be two and half (2.5) and water absorption shall not exceed six (6) percent for stones to be used in riprap. The stone shall not have an abrasion loss greater than forty-five (45) percent when subjected to five hundred (500) revolutions in a Loss Angeles Abrasion test. Stones for riprap shall be one of the following classes as shown on the Drawings or determined by the Engineer: -

1. Class A

Stones ranging in weight from a minimum of fifteen (15) Kg to a maximum of twenty-five (25) Kg, with at least 50 percent by weight of the stones weighing more than twenty (20) kg.

2. Class B

Stones ranging in weight from a minimum of thirty (30) kg to a maximum of seventy (70) kg, with at least fifty (50) percent by weight of the stones weighing more than fifty (50) kg.

3. Class C

Stones ranging in weight from a minimum of sixty (60) Kg to a maximum of hundred (100) Kg with at least 50 percent by weight of the stones weighing more than eighty (80) Kg.

Sound pieces of broken concrete obtained from the removal of bridges, culverts and other structures maybe substitutes for stone upon approval by the Engineer.

16.7.9.2.2 Filter Material

- The grading of the filter material shall be as specified on the drawings or in the Special Provisions. If not otherwise specified, it will be required that D15 of the filter is at least 4 times as large as D15 for the underlying embankment materials and not more than 4 times the D85 for the embankment material.
- Where: D 15 and D85 are the particle diameters corresponding to fifteen (15) percent and eighty-five (85) percent respectively, passing (by weight) in a grain size analysis.

16.7.9.2.3 Portland Cement

Portland cement shall conform to the requirements of AASHTO M 85.

16.7.9.2.4 Fine Aggregates

Fine aggregates for mortar shall conform to the requirements of AASHTO M 45.

16.7.9.2.5 Steel Reinforcement

Steel reinforcement shall be furnished, bent and fixed where shown on the drawings. Furnishing, bending and fixing shall be in accordance to 'Scarification of existing road/ Breaking of road Pavement layer.'

16.7.9.2.6 Concrete

Concrete of specified Class shown on the Drawings shall be supplied placed, finished and used as indicated in 'Concrete'.

16.7.9.2.7 Water

Water for concrete and mortar of ratio 1:3 shall conform to 'Concrete' & 'Water'.

16.7.9.3 Construction Requirement

16.7.9.3.1 Excavation

- The bed for the riprap shall be excavated to the required depths and compacted, trimmed and shaped to the entire satisfaction of the Engineer or as shown on the plans.
- The riprap shall be set in a toe trench as shown on the Drawings. The toe trench shall be filled with stone of the same class as the one specified for the riprap, unless otherwise specified. All toe trenches and excavations shall be approved by the Engineer with firm subgrade or base prior to placement of zones stones shall be placed so as to provide minimum of void a larger stone shall be placed in the toe trench and on the outside surface of the slope.

16.7.9.3.2 Placing

Stones placed below water line shall be distributed so that the minimum thickness of the riprap is not less than that specified. Stones above the waterline shall be placed by hand. They shall be laid with close, broken joints and shall be firmly bedded into the slope and against the adjoining stones. The stones shall be laid perpendicular to the slope with ends in contact. The riprap shall be thoroughly compacted as construction progresses and the finished surface shall present an even, tight surface. Interstices between stones shall be chinked with spalls firmly rammed into place.

Unless otherwise provided, riprap shall have the following minimum thickness, measured perpendicular to the slope: -

- Class A: 20 cm/8"
- Class B: 45 cm/18"
- Class C: 60 cm/24"

The surface of riprap placed above the water line shall not vary from the theoretical surface by more than 8 cm/3" at any point.

16.7.9.3.3 Loose Riprap

The loose riprap shall be placed in layers manually or other methods approved by the Engineer, all to secure a stable mass. Surface irregularities of the slope shall not vary more than eight (8) centimeters along the intended slope. After the completion and approval of the riprap placement, the surface voids of the riprap in the footing trench and on the lower portions of the slope shall be filled with excavated material and dressed to the satisfaction of the Engineer.

16.7.9.3.4 Grouted Riprap

- Stone for this purpose shall, as far as practicable, be selected of the size and shape so as to secure fairly large, flat surfaced stone which will lay up with a true and even surface and a minimum of voids. The stones shall be placed first and roughly arranged in close contact, the larger stones being placed near the base of the slope. The spaces between the larger stones shall be filled with stones of suitable size; leaving the surface smooth, reasonably tight, and conforming to the contour required. In general, the stone shall be laid with a degree of care that will ensure for plane surfaces a maximum variation from a true plane of not more than three (3%) percent, Warped and curved surfaces shall have the same general degree of accuracy as specified above for plane surface.
- As each of the larger stones is placed, it shall be surrounded by fresh mortar and adjacent stones shall be shoved into contact. After the larger stones are in space all of the spaces or open Logs between them shall be filled with grout consisting of one (1)

part of Portland Cement and three (3) parts of fine aggregates; and one fifth (1/5) part of hydrated lime with sufficient water to produce a plastic mix and the smaller stones then placed by shoving them into position, forcing excess mortar to the surface, and ensuring that each stone is carefully and firmly bedded laterally. Mortar shall not be placed in temperature lower than five (5°) degree C: During hot, dry weather the work shall be protected from the sun and kept moist for a minimum of 3 days after placement. Stones shall be kept wet during placing of the mortar.

- After the work has been completed as above described, all excess mortar 'forced up shall be spread uniformly to completely fill all surface voids. All surface joints shall then be roughly pointed up either with flush joints or with shallow, smooth raked joints.
- Weep holes shall be provided through the riprap cover as shown on the plans or as directed by the Engineer.

16.7.9.3.5 Reinforced concrete slope protection

- The slopes with suitable material shall be prepared with appropriate compaction to form a subgrade approved by the Engineer and formwork shall be completed accordingly.
- After furnishing and fixing the steel reinforcement, reinforced concrete slope protection shall be constructed after light spray of water at the locations shown on the plans or where directed by the Engineer. Placing and finishing of concrete shall conform to the requirements specified in Item.

16.7.9.4 Measurement and Payment

16.7.9.4.1 Measurement

- The quantities to be measured for payment shall be the number of cubic meters/cubic feet of completed and accepted work placed to the designated thickness on slopes including the toe wall as shown on Drawings.
- A filter layer of granular material, when required, shall be measured separately by the cubic meters, in place and accepted,
- The computation of the quantities will be based on the volume within the theoretical limiting dimensions designated on the Drawings.
- These works shall include the furnishing of all material, placing and grouting stone riprap, mixing and placing concrete including reinforcement. Excavation, backfilling and slope preparation shall not be measured for payment but will be considered subsidiary to the Section of "Riprap" or "Slope Protection".

16.7.9.4.2 Payment

The quantities, measured as provided above shall be paid for at the contract unit price, for each of the pay items listed below and shown in the Bill of Quantities. Payment shall be full compensation for furnishing all materials, labor, equipment, tools supplies and all other costs related to completion of the work.

Pay Item No.	Description	Unit of Measurement
16.7.9.4.2.1	Riprap, Class A	CM/100 cft
16.7.9.4.2.2	Riprap, Class B	CM/100 cft
16.7.9.4.2.3	Riprap, Class C	CM/100 cft
16.7.9.4.2.4	Grouted Riprap, Class A	CM/100 cft
16.7.9.4.2.5	Grouted Riprap, Class B	CM/100 cft

16.7.9.4.2.6	Grouted Riprap, Class C	CM/100 cft
16.7.9.4.2.7	Reinforced Concrete Slope Protection	CM/100 cft
16.7.9.4.2.8	Filter Layer of granular Material	CM/100 cft
16.7.9.4.2.9	Steel Reinforcement of Specified Grade for Reinforcement Cement Concrete	kg

16.7.10 Stone Pitching

16.7.10.1 Description

Where shown on the Drawings, this work shall consist of furnishing hand set pitching laid dry or grouted to stabilize slopes or as air protection against water or other erosion to form a flat or cured surface as directed by the Engineer. All materials regardless of type or kind shall be placed as per the lines and levels called for on the plans.

16.7.10.2 Material Requirements

16.7.10.2.1 Stones

The stones shall comprise good, hard and durable broken boulders or pieces of rock. These shall be sound, dense, resistant to the action of air and water and suitable in all respects for the purpose intended. Stones of class I or II shall be used in pitching, shall conform to the following specifications. The depth of the stones and their weight shall be as under Class I.

1. Class I

Stones shall be ranging in weight from a minimum of fifteen (15) Kg/32 lbs. to a maximum of twenty-five (25) Kg/55 lbs. with at least fifty (50%) percent by weight of the stones weighing more than twenty (20) Kg/43 lbs. The depth of the stones shall generally be from twenty (20) cm/8" to twenty-five (25) cm/10" and shall be used for heavy pitching to culvert or bridge ends and approaches, Water diversions, protection for structures, revetment to slopes and where directed.

2. Class II

Stones are ranging in weight from a minimum of ten (10) Kg/22 lbs. to a maximum of fifteen (15) Kg/33 lbs. with at least fifty (50) percent by weight of the stones weighing more than twelve (12) Kg/26 lbs. The depth of the stones shall vary from fifteen (15) cm to twenty (20) cm/6" to 8" and shall be used for lighter pitching where directed to ditches, beams, dykes etc.

16.7.10.2.2 Portland Cement

Portland cement shall conform to the requirements of AASHTO M-85.

16.7.10.2.3 Fine Aggregates.

Fine aggregates for mortar shall conform to the requirements of AASHTO M-45.

16.7.10.2.4 Water

Water for cement sand mortar shall be as specified in 'Concrete'.

16.7.10.3 Construction Requirement

16.7.10.3.1 Dry Pitching

- The bed upon which pitching shall be laid, shall be firm or compacted of approved granular material of specified thickness and to the required grades and lines as shown on the plans or as directed and approved by the Engineer. The stones shall comprise roughly dressed and shaped, set on their edges with their longest dimension at right angles to the flow of water. These shall be securely bedded breaking bond closely packed with any interstices locked and filled by selected stone spalls hammered in. The loose; pitching specified in plans shall be placed by dumping and spreading in layers by hand or other methods approved by the Engineer all to secure a stable mass. The ends of pitched areas shall be protected from undermining by the use of edge stones at least twice the general size and weight set on end. In large or slope areas of pitching, key stones shall be provided at the rate of one per square meter, at least one and a half times the general size and weight, set on end.
- The pitching to the batters of the earth works and diversions of waterways shall be carried down in trench to such a depth as will ensure a sound footing for the lowest course. Subsequent to pitching the trench shall be backfilled to normal ground level with approved, well compacted suitable material.

16.7.10.3.2 Grouted Pitching

- Specified stones shall be arranged in such a way that the largest stones are at the base of the slope. The surfaces of the rock shall be cleaned of adhering dirt and clay and shall be moistened. Stone in the bottom courses and to a vertical height and thickness as per plans shall be carefully arranged by hand to inter lock and so as to yield true and even surface with minimum voids and conforming to the contour required. Pitching laid in cement mortars of 1:3 shall be furnished in panels with weep holes, the joints between panels being approximately two (2) cm/3/4" in thickness and extending the full depth of the pitching. The joints shall be filled with sand bitumen mixture consisting of approximately one part by weight of bitumen heated as necessary to two parts by weight of a clean sharp sand.
- The dimensions of the panels shall be approximately two meters square but the precise dimensions in any instance and the spacing of the weep holes shall be as required by the Engineer. In laying the pitching the lines of the panel joints shall be picked out with a straight fillet laid on the face of the earth works and the stones set up carefully to the edge of the fillet. Subsequent to the laying, pitching fillet shall be removed and the joint caulked with the sand bitumen mixture as above. The exposed surface of the stones shall project not less than four (4) centimeters/1-1/2" and not more than eight (8) centimeters/3" of the grout surface. The grouted stone pitching shall be cured by an approved method for a minimum period of four (4) days and after expiration of the curing period, the exposed surfaces shall be cleared of all curing mediums.

16.7.10.4 Measurement and Payment

16.7.10.4.1 Measurement

The quantities shall be measured by the square meter of completed and accepted work placed to the designated thickness of slopes including the toe walls as shown on Drawing. Toe walls shall be measured by the height times the length, and no additional payment will be made for the additional thickness of the toe walls when compared to the slope thickness. Measurement shall be based on the dimensions shown on the plans or as otherwise specified by the

Engineer. These works shall include the furnishing of all material, placing and grouting stone pitching. Excavation, backfilling and slope preparation shall not be measured for payment, but will be considered subsidiary to the Section of "Stone Pitching".

16.7.10.4.2 Payment

The amount of completed and accepted work as measured above shall be paid for at the contract unit price for each of the pay items listed below and specified in the Bill of Quantities, which price shall be full compensation for furnishing all materials, for all labor, equipment, tools, supplies, and all other item necessary for the completion of the work.

Pay Item No.	Description	Unit of Measurement
16.7.10.4.2.1	Grouted Stone Pitching	SM
16.7.10.4.2.2	Dry Stone Pitching	SM

16.7.11 Ditch Lining and Wash Checks

16.7.11.1 Description

This work shall consist of the construction of stone or concrete ditch and/or wash checks, in accordance with the specifications and in conformity with the lines, grades and cross-sections shown on the drawings or as directed by the Engineer.

16.7.11.2 Material Requirements

Materials shall conform to the requirements specified in the following items.

16.7.11.2.1 Reinforcing Steel

Reinforcing steel shall conform to specifications.

16.7.11.2.2 Concrete

Concrete for ditch lining and wash checks shall be as specified in 'Concrete'.

16.7.11.2.3 Stone and Mortar

Stone and mortar for grouted stone ditch lining or grouted stone wash checks, shall be as specified in Item for Riprap and reinforced concrete slope protection.

16.7.11.3 Construction Requirement

16.7.11.3.1 Excavation

The sub-grade for the ditch lining or wash checks shall be excavated to a smooth surface parallel to the proposed finished surface and to a depth sufficient for the full thickness of the lining or wash checks as shown on the drawings. Unstable sub-Grade material shall be removed and replaced with suitable materials as approved by the Engineer.

16.7.11.3.2 Concrete Ditch Lining and Wash Checks

- Concrete ditch lining and wash checks shall be constructed of Class A concrete. The composition, consistency, proportioning, mixing, and protection of the concrete shall conform to the requirements of 'Concrete'. Placement of concrete for ditch lining shall begin at the lower end of the portion of the ditch to be lined and progress toward the upper end.
- If shown on the plans, the concrete shall be reinforced with the type of reinforcement and in the manner indicated. Contraction or construction joints shall be spaced and formed as indicated in the plans.
- The surface shall be finished with a wooden float. Bridges for Workmen shall be used to avoid walking in the freshly laid concrete.
- Immediately after the finishing operations are completed, the concrete shall be protected and cured in a manner as approved by the Engineer.

16.7.11.3.3 Stone Ditch Lining and Stone Wash Checks

1. Stone Ditch Lining

The stones shall be placed in rows transversely to the centerline of the ditch in the manner indicated on the plans. The stones shall be placed with ends and sides abutting and the joints between stones in each row breaking with the joints in the preceding row. The larger spaces between stones shall be filled with spalls. The stones shall be rammed or compacted to give them firm bearing and stability.

2. Stone Wash Checks

- The stones for wash checks shall be laid to form a structure of the dimensions shown on the plans. The sides and ends of the stones shall be in contacts much as the sizes and shapes of the stones will permit. Spalls shall be rammed into the larger spaces between stones to form a solid wall. Joints between stones in one row shall break with Joints between stones in the adjacent rows.
- Stone wash checks may be substituted with concrete wash checks, constructed by class A concrete, if approved by the Engineer at no extra cost to the contractor or client.

3. Grout

- After the surface has been inspected and approved, the spaces between stones shall be completely filled with a grout composed of one (1) part of Portland Cement and three (3) parts of fine aggregate mixed with sufficient water to produce a plastic mortar. The grout shall be brushed or broomed into the spaces to ensure proper filling.
- The grout shall be cured in the manner as provided for "Grouted Riprap in 16.7.9. "Riprap and Reinforced Concrete Slope Protection."

16.7.11.4 Measurement and Payment

16.7.11.4.1 Measurement

1. Ditch Lining

Ditch lining shall be measured in square meter by multiplying the exposed face width to the length of ditch and accepted in place as measured along the finished surface as shown in the plans or authorized by the Engineer.

2. Wash Checks

Wash checks shall be measured according to the linear meter of wash checks complete and accepted in place. Measurement shall be made perpendicular to the ditch centerline along the top surface and at the upstream edge of each wash check.

16.7.11.4.2 Payment

1. Ditch Lining

The amount of completed and accepted Work as measured, will be paid for at the unit price(s) bid per square meter as specified in the Bill of Quantities for "Concrete Ditch Lining" or "Grouted Stone Ditch Lining" which price(s) shall be full compensation for furnishing, transporting, and placing all materials, including reinforcement, if required, for all excavation, backfilling and for all labor, tools, and all other items necessary for the proper completion of the Work.

2. Wash Checks

The amount of completed and accepted Work as measured will be paid for at the unit price(s) bid per linear meter as specified in the Bill of Quantities for 'Concrete Wash Checks" and "Grouted Stone Wash Checks." which price(s) shall be full compensation for all excavation, backfilling. for all materials, for all labor, equipment, tools and all other items necessary for the proper completion of the Work.

Pay Item No.	Description	Unit of Measurement
16.7.11.4.2.1	Concrete Ditch Lining type --	SM
16.7.11.4.2.2	Grouted Stone Ditch Lining type --	SM
16.7.11.4.2.3	Concrete Wash Checks type--	M
16.7.11.4.2.4	Grouted Stone Wash Checks type --	M

16.7.12 Bridge Drainage System

16.7.12.1 Description

This work shall consist of furnishing and placing scuppers, drainage troughs and downspout systems for bridge drainage as shown on the plans and in accordance with the specifications.

16.7.12.2 Material Requirements

Cast Iron Scuppers	ASTM A48M, Class 30 and 715-05
Fabricated Steel Scuppers (Except Gratings) Plates or Bars Tubes Headed Concrete Anchor Studs	ASTM A36 and 715-011 ASTM A500, Grade B1 ASTM A108, Grade 1015 or 1020
Grating Plates and Bars	ASTM A36, A242, or A572, and 715-011
Bolts and Cap Screws	ASTM A307 Grade A

Drainage Troughs (PVC)	705-11
Steel For Erection of Trough Bars ² (A1, A2) and Plates ² (B1, B2, C1 and C2) Rods (fully threaded) and Bolts ³ Clamps, Malleable Iron	ASTM A575, Grades 1015 and 1020 ASTM A307 ASTM A47/A47M, Grade 32510 and 715-09
Ductile Iron Downspout Pipe and Pipe Fittings	ASTM A377 (ANSI 21.51) ⁴
Pipe Couplings ⁵ (Ductile Iron or Malleable Iron)	ASTM A536 or A47/A47M Grade 32510
Hoppers ⁶	ASTM A36 and 715-01
Pipe Brackets and Supports	ASTM A575, Grade 1015 and 1020
Anchors	GSA FS-S-325 Group I, Type I, Class I
Nuts and Bolts ⁶	ASTM A307

Table 80, Material Requirement

16.7.12.3 Construction Requirements

1. Fabrication

a. Shop Drawings

Shop drawings will not be required for scuppers, drainage troughs or downspout systems.

b. Welding

- **Fabricated Steel Scuppers, Gratings.** Welding shall conform to the provisions of the SCM. Weld inspection shall be done in accordance with the requirements of the SCM but radiographic testing will not be required. All groove welds shall be complete joint penetration groove welds unless otherwise approved by the DCES.
- **Drainage Troughs.** Field Welding (by heat) of the polyvinyl chloride trough material shall not be allowed without written permission of the Deputy Chief Engineer (Structures).

c. Galvanizing

- **Scuppers and Troughs.** Galvanizing shall conform to the requirements of Galvanized Coatings and Repair Methods. Galvanizing shall be done after all welding and fabrication is completed.
- **Bolts, Fully Threaded Rods and Nuts.** All bolts and rods shall have a ANSI B1.13M Class 6H thread. All galvanized nuts shall have a standard oversize tap to allow for the galvanizing on the bolts, rods and nuts.

d. Gratings

Gratings for Types B1 and B2 scuppers shall have a full and even bearing on the underlying surface.

e. Basis of Acceptance

Scuppers, drainage troughs and downspouts shall be accepted at the work site by the Engineer-in-Charge upon certification of the manufacturer that the materials used and fabrication procedure employed conform to the requirements of Bridge Drainage System. The Engineer may reject any scupper, drainage trough or downspout system which, in his opinion, exhibits poor quality or workmanship.

2. Erection of Downspout Systems

a. General

- **Pipe Installation.** The pipe shall be laid true to line and grade as shown on the plans or as directed by the Engineer, with joints close and even, so that a true and even surface of invert will be made over the joints throughout its entire length. Horizontal pipe shall be installed so that the minimum slope shall not be less than 1:50. Pipe shall be placed in accordance with the requirements of this specification unless special methods are called for on the plans or in the itemized proposal.
- **Field Testing.** Prior to the acceptance of the structure by the Department, the downspout system should be flushed out and tested to ensure that it is flowing at full capacity. Any obstruction in the downspout system preventing the free flow of drainage or its operation at full capacity shall be removed to the complete satisfaction of the Engineer.

b. Ductile Iron Downspouts

- **Pipe Supports.** Supports for horizontal piping shall be spaced 5 feet maximum. Supports for vertical piping shall be spaced 6 feet maximum.
- **Pipe Joints.** All joints in pipe, except when encased in concrete, shall be made with groove type couplings. Pipes encased in concrete shall have joints formed in accordance with the pipe manufacturer's recommendations.
- **Painting.** All metal embedded in concrete shall not be painted. All other metallic portions of the downspout system shall be painted in the field in accordance with the requirements of the contract documents. Color shall be as shown on the plans.

c. PVC Downspouts and Protective Insulator

- **Pipe Joints.** PVC pipe joints shall be sealed in the following manner: All necessary cuts shall be square and clean from burrs. Mating surfaces of pipe and fittings shall be cleaned with methyl ethyl ketone or acetone prior to solvent cement application. The solvent cement shall be applied as recommended by the manufacturer. The pipe and fitting should be joined with a twisting motion to distribute cement uniformly. The solvent cement manufacturer's recommendations for cure time shall be followed.
- **Protective Insulator.** The protective insulator shall be attached to the pipe in such a manner so as to prevent its dislodgement as the concrete is placed. Suitable methods would include taping the joints with a weather resistant tape or bonding with a non-metallic substance.
- **Form Wire.** The PVC pipe and its protective insulator shall be held in place by form wire in such a manner as to provide sufficient lateral support to prevent movement as the concrete is placed.
- **Vibrator.** Particular caution shall be taken to prevent the vibrator from striking the pipe and its protective insulator during the placing of concrete.

16.7.12.4 Measurements and Payment**1. Method of Measurement****a. Scuppers**

Payment will be made at the unit price bid for each type of scupper furnished and placed as shown on the plans and in accordance with the specifications.

b. Drainage Troughs

The trough shall be measured as the number of feet measured along the center line of each polyvinyl chloride section, furnished and placed as shown on the plans and in accordance with the specifications.

c. Downspout System

The downspouts will be measured as the number of feet measured along the center line of pipe between the extreme outer limits of downspouts, including hoppers, furnished and placed as shown on the plans and in accordance with the specifications.

2. Basis of Payment**a. Scuppers**

The unit price bid for each type of scupper shall include the cost of furnishing all labor, equipment and materials necessary to set the scupper to its proper line and grade. No additional payment will be made for furnishing and placing the grating for the Type B1 or B2 scupper.

b. Drainage Troughs

The unit price bid per foot shall include the cost of furnishing all labor, materials and equipment necessary to erect the trough and its threaded rod supports as indicated on the plans.

c. Downspout System

- **General.** The unit price bid per foot shall include the cost of furnishing all labor, materials and equipment necessary to erect the pipe and pipe fittings, pipe supports, hoppers, nuts, bolts, washers, to provide cleanouts if indicated on the plans, straps to cap and plug the pipe if necessary, and to replace cracked or otherwise defective material necessary to complete the work.
- **Ductile Iron Downspouts.** The unit price bid per foot shall also include the cost of furnishing and placing pipe hangers and brackets, grooved type couplings and paint.
- **PVC Downspouts and Protective Insulator.** The unit price bid per foot shall also include the cost of furnishing and placing the protective insulator and all adaptor fittings required at the juncture of PVC Pipe and Ductile Iron Pipe.
- Payment will be made under: -

Item No.	Description	Unit
16-57	Scuppers (Type A & Type B)	Each

16.7.12.4	Drainage Trough	Foot
16.7.12.4	Downspout System (Ductile Iron)	Foot
16-68	Downspout System (PVC)	Foot
16.7.12.4	Downspout System (Ductile Iron and PVC)	Foot

16.8 Ancillary Works

16.8.1 General

This section shall consist of items of work which are ancillary or incidental to the other parts of the General Specifications. Such works shall include general items, precast concrete posts and markers, traffic control devices, sidewalks, guard rails, detours, traffic signs, pavement marking, reflectors, fencing and brick edging etc. in accordance with these specifications and in conformity with the lines, grades, sections, dimensions and locations in the plans or as required by the Engineer. This section deals with those items of work in which small elements of construction employ construction items such as concrete, brick work, stone masonry, steel reinforcement or structural steel. These items of work have been separately quantified so that contractor can price them by assessing the cost of each element and extra effort which is essential in addition to the specification requirement of the parent item. Metal guard-rails, traffic road signs and safety devices, pavement markings, reflectorized pavement studs, and other such fixtures shall meet the requirements of ISO - 9000 for which certificates of manufacturers and supplies shall be produced.

16.8.2 Concrete curb, Gutters and Channels

16.8.2.1 Description

This work shall consist of curb, gutter, or combination of curb and gutter, constructed of the following materials and in accordance with the specifications at the location and of the form, dimensions and designs shown on the drawings or as directed by the Engineer. The Curb, gutter or combination of curb and gutter may be constructed by one of the following ways: -

- Cement Concrete Cast in place or
- Pre-cast Cement Concrete

16.8.2.2 Material Requirements

16.8.2.2.1 Cement Concrete for Cast in Place Units

The cement concrete for cast-in-place curb, gutter or combination of curb & gutter shall be type C and shall conform to the requirements of 'Concrete'. The units shall be cast as per details shown on the drawings.

16.8.2.2.2 Cement Concrete for Pre-cast Units

Cement Concrete for pre-cast curb, gutter or combination of curb & gutter shall consist of Type C cement concrete, conforming to the requirements of 'Concrete' and to the length, shapes and other details shown on the drawings.

16.8.2.2.3 Reinforcing Steel

Reinforcing Steel shall conform 'Steel reinforcement'.

16.8.2.2.4 Joint Filler

Expansion joint filler shall be either the preformed type conforming to the requirements of AASHTO M 153 or shall be pre-cut fiber-board packing.

16.8.2.2.5 Joint Mortar

- Joint mortar shall consist of one-part cement and two parts of approved sand with water added to obtain the required consistency.
- The mortar shall be used within 30 minutes of preparation. The bounding compound when used shall conform to AASHTO M-200.

16.8.2.3 Construction Requirement

16.8.2.3.1 Cast in Place Units

1. Excavation and Bedding

Excavation shall be made to the required depth and the base upon which the curb gutter, gutter or combination of curb and gutter is to be set. It shall be compacted to a firm, even surface. All soft and unsuitable material shall be removed and replaced with suitable material acceptable to the Engineer. The surplus or unsuitable material resulting from Excavation shall be disposed off as directed by the Engineer. When directed by the Engineer a layer of clean sand and gravel or other approved quarry material, having minimum compacted thickness of 15 cm (6 in) shall be placed to form a bed for the curb, gutter or combination of curb and gutter.

2. Forms

Forms to hold the cement concrete shall be built and set in place as described under Section 8-4. Forms for at least 60 meters (200 feet) of curb, gutter or combination of curb and gutter shall be in place and checked for alignments and grade before concrete is placed. Curb gutter or curb and gutter constructed on curves shall have forms of either wood or metal and they shall be accurately shaped the radius of curvature shown on the drawings. Mixing, placing, and curing of concrete shall be in accordance with 'Concrete' and the requirements given below.

3. Placing Cement Concrete

Cement Concrete may be placed to the full depth required. The top of the curb gutter or combination of curb and gutter shall be floated smooth and the edges rounded to the radii shown on the Drawings. Before finishing, the surface of the gutter or curb or combination of both shall be tested with a 3-meter (10 feet) straight edge and any irregularities of more than 5 mm (3/16 inch) shall be eliminated. In finishing concrete, only mortar normally present in the concrete shall be permitted for finishing. The use of a separate mortar finishing coat or the practice of working dry cement into the surface of the concrete will not be permitted.

4. Joints.

- The curb and gutter shall be constructed in uniform sections of 25 meter (82 feet) in length except where shorter sections are required to coincide with the location of weakened plane or contraction joint of the concrete pavement or for closures but no section shall be less than 2 meters (6-1/2 feet) long. The sections shall be separated by approved templates set perpendicular to the face and top of the curb and gutter. The templates shall be approximately 5 mm (3/16 inch) in thickness, of the same width as that of the curb and gutter and not less than 5 cm (2 inch) greater than the depth of the curb and gutter. Templates shall be set carefully and held firmly during the placing of the concrete and shall be allowed to remain in place until the concrete has set sufficiently to hold its shape, but shall be removed while the forms are still in place.

When pre-cut fiberboard packing is used in the expansion joints it may be used in place of the approved template referred to above, on the approval of the Engineer. In this event the fiberboard shall be pre-cut to the shape of the curb so that its outer edge will be flush with the abutting curb.

- Expansion joints shall be formed in the curb and gutter at intervals of approximately 25 meters (82 feet) in order to coincide with the expansion joints of cement concrete pavement or as shown on the drawings.

5. Dowels at Expansion Joints in Channels

- At expansion joints in channels and in the channel portion of curbs and channel built monolithically, painted dowel bars with slip sleeve shall be provided as a load transfer medium at locations shown on the Drawings.
- The size and spacing of the dowel bars shall be as indicated on the Drawings. Each dowel shall be set accurately parallel to the top surface of the gutter and accurately at right angles to the expansion joint.

6. Contraction Joints

- Transverse contraction joints shall be provided opposite to all contraction joints in abutting concrete pavement and other locations shown on the Drawing spaced to a maximum of four (4) meters.
- The contraction joints shall be provided by forming grooves in the face and surface of structure at right angle to the curb alignment and curb surface. The grooves shall be rectangular in cross-section, five (5) cm deep by five 5cm wide. The grooves shall be formed in the top of all curbs and in the exposed roadway face of curb and in the channel surface of monolithic type curb and channels and in the surface of channels. The edges of the joints shall be tooled and the joints shall be left clean, neat and of specified width and depth.

7. Removal of Forms and Finishing

The forms shall be removed 24 hours after concrete has been placed except that the form used against the face of the curb in a combination of curb and gutter shall be removed as soon as the concrete has set sufficiently to hold its shape. Minor defects shall be repaired with mortar containing one part of Portland cement and two parts of approved sand. Plastering shall not be permitted on the face of a curb or curb and gutter and all rejected curb or gutter shall be removed and replaced without additional compensation. All surfaces which will be exposed in the finished construction of the curb and gutter shall be finished while the concrete is still "green" by wetting a wooden float and rubbing the surface until they are smooth.

8. Curing

Immediately upon the completion of the rubbing down, the surface shall be moistened and kept moist for 3 days. Other methods of curing shall be adopted on the approval of the Engineer. The concrete shall be cured by covering with suitable cotton or Hessian mats and by frequent sprinkling with water with liquid forming compounds subject to approval of Engineer.

9. Backfilling

After the concrete has been cured as specified, spaces on back of the curb or curb and gutter excavated for placing the curb or curb and gutter shall re-filled to the required elevation with

suitable earth or granular material, which shall be tamped in layers of not more than 15 cm (6 inch) each until firm and solid.

16.8.2.3.2 Pre-cast Units

1. Excavation and Bedding

- Excavation shall be made to the required depth as shown on the drawings. All soft and unsuitable material shall be removed and replaced with a suitable material acceptable to the Engineer. The surplus or unsuitable material resulting from excavation shall be disposed off as directed by the Engineer.
- Bedding shall consist of Class B Cement Concrete conforming to the requirements of 'Concrete' and shall be to the section and dimensions shown on the drawings.

2. Placing

The pre-cast concrete curbs shall be set in 2 cm (3/4 inch) of cement mortar to the line level grade as shown on the drawings or as directed by the Engineer. Pre-cast units which show surface irregularities of more than 5 mm (3/16") under a 3 meter (10 feet) straight edge or surface pits more than 12.5 mm (1/2") in diameter will be rejected.

3. Joints

Joints between consecutive units shall be 3 to 5 mm (1/8" to 3/16") wide & filled with cement mortar to the full section of the unit.

4. Backfilling

Backfilling shall meet the requirements as states above.

16.8.2.4 Measurement and Payment

16.8.2.4.1 Measurement

- All curb, gutter or combination of curb and gutter shall be measured by the linear meter or foot along the front face of the section at the finished grade elevation. Deductions in length will be made for drainage structures installed in the curbing such as catch basin and drop inlet, etc.
- Bed course material shall be measured by the cubic meter of material compacted in place.
- Cement concrete and cement mortar that may be required for bedding to pre-cast concrete curbs as shown in the drawings shall not be measured for payment as separate items, but the cost shall be included in the contract unit price for pre-cast concrete curbs.

16.8.2.4.2 Payment

The accepted quantities of curb or gutter or combination of curb and gutter shall be paid for at the contract unit price per linear meter or foot for each of the particular pay items listed below and shown in the Bill of Quantities, which payment shall constitute full compensation for furnishing and placing all materials for concrete, for reinforcing steel if required on the drawings, for expansion joints, materials, forms for drainage opening, excavations bedding, backfilling and dumping and disposal of surplus materials and for all labor equipment, tools

and incidentals necessary to complete the work. Compacted bed course material shall be measured in cubic meter and shall be paid separately. Payment shall be made as under: -

Pay Item No.	Description	Unit of Measurement
16-76-a, b, c	Cast-in-situ Cement Concrete Curb stone of all sizes.	Rft
16.8.2.5.2	Cast-in-situ Cement Concrete Gutter	Per meter (m) /Rft
16.8.2.5.2	Pre-cast Concrete Curb	Per meter (m) /Rft
16.8.2.5.2	Pre-cast Concrete Gutter	Per meter (m) /Rft
16.8.2.5.2	Combination of Curb, gutter and channel in place	Per meter (m) /Rft
16.8.2.5.2	Concrete channel	Per meter (m) /Rft
16.8.2.5.2	Compacted Bed Course	Per cubic meter (m ³)/ 100 cft.

16.8.3 Asphalt Concrete and Cement Concrete Sidewalk

16.8.3.1 Description

This work shall consist of the construction of sidewalks which can be asphalt concrete, plain Portland cement concrete, or precast Portland cement concrete slabs (450 x 450 mm) 18 x 18 inch. It mm or smaller or interlocking concrete blocks all in accordance with these specifications and to the line, grade, levels and dimensions shown on the drawings or as required by the Engineer.

16.8.3.2 Material Requirements

16.8.3.2.1 Cement Concrete

The concrete shall be either Class A or Class C as indicated on the drawings and in accordance with 'Concrete'.

16.8.3.2.2 Asphalt Concrete

Asphaltic Concrete shall conform to the requirements of Asphalt Concrete Pavement – for Class B mixture.

16.8.3.2.3 Expansion Joint Filler

Unless otherwise directed the joint filler shall have a thickness of five (5) mm and conform to the requirements of 16.8.2.2.4.

16.8.3.2.4 Forms

Forms shall be of wood or metal as approved by the Engineer and shall extend to the full depth of the concrete. All forms shall be straight, free from warp and of adequate strength to resist bending.

16.8.3.2.5 Bed Course Material

Bed course material shall consist of cinders, sand, slag, gravel, crushed stone or other approved material of such gradation that all particles will pass through a 1/2" (12.5 m) sieve.

16.8.3.2.6 Asphaltic Prime Coat

Asphaltic prime coat material shall conform to the requirements of the 'Bituminous Prime Coat' for Cut-back Asphalt

16.8.3.3 Construction Requirement

16.8.3.3.1 Asphalt Concrete Sidewalk

1. Excavation

- Excavation shall be made to the required depth and to a width that will permit the installation and bracing of the forms.
- The foundation shall be shaped and compacted to minimum 90% of the maximum dry density as determined by AASHTO T-191 Method. The surface shall be even conforming to the section shown on the drawings. All soft and yielding material shall be removed and replaced with approved material.

2. Placing of Bed Course Material

The bed course material shall be compacted in layers not exceeding 10 cm (4 inch) to the depth and to the line, grade levels dimensions as shown on the drawings.

3. Priming the Bed Course Material

The prepared bed course material shall receive an application of prime coat in accordance with the requirements of 'Bituminous Prime Coat' and approved by the Engineer.

4. Placing the Asphalt Concrete

The asphalt concrete shall be placed on the previously primed prepared bed only when, in the opinion of the Engineer the bed is sufficiently dry and weather conditions are suitable. The mixture shall be placed on one or more courses of uniform thickness as shown on the Drawings. Each course shall be thoroughly compacted by rolling with a hand operated roller or a type satisfactory to the Engineer. After compaction, the surfacing shall be of the thickness and section shown on Drawings, shall be smooth, even and of a dense and uniform texture. Forms, if used, shall be removed and the shoulders shaped and compacted to the required section.

16.8.3.3.2 Cement Concrete Sidewalk

1. Excavation

Excavation shall meet the requirements of 'Structural Excavation and Backfill'.

2. Placing of Bed Course Material

Where indicated on the drawings the bed course material shall be placed in accordance with 16.3.1.

3. Forms and Expansion Joints

All forms shall be staked securely in position at the correct line and elevation. Expansion joint filler shall be set in the position shown on the Drawings before the placing of the concrete is started. The joint filler shall be placed 5mm below the top surface of the finished sidewalk.

4. Placing the Cement Concrete Material

- The mixing, placing, finishing and curing of concrete shall be as provided under 'Concrete'.
- Before the concrete has set, the surface of the concrete shall be troweled until it is of uniform smoothness and is true to the lines, elevations, and surface required.
- The surface shall be cut through to a depth of 1 cm (3/8") with a trowel at intervals of 1 meter (3 feet) or where required, in straight lines perpendicular to the edge of the sidewalk. The surface shall then be brushed. The edges of the sidewalk and the transverse cuts shall be shaped with a suitable tool so formed as to round the edges to a 1.5 cm (5/8") radius.

5. Precast Elements

- Precast concrete slabs or interlocking concrete blocks shall be set on the bed course material where indicated on the Drawings or as directed by the Engineer to provide a smooth top surface without ridges or lumps at joints.
- Precast concrete units shall be fair faced cast to the sizes and dimensions as indicated on the Drawings.
- The concrete used for pre-cast unit shall conform to the specifications laid down in 'Concrete'. The Contractor shall be required to submit a sample of precast unit for the approval of the Engineer. All precast units shall strictly conform to the approved sample.
- A precast unit cracked or damaged before, during or after erection shall be removed from the works and replaced by the Contractor at his own expense. All precast units shall be smoothly finished to the required lines, grades, angles etc. Holes, grooves, pockets, hooks shall be provided as shown or as directed by the Engineer.
- The units shall be properly stacked on a platform without causing any cracks or damage. Curing of all the precast units shall be done in accordance with 'Concrete'.

16.8.3.4 Measurement and Payment

16.8.3.4.1 Measurement

The quantity to be paid for shall be area of asphalt concrete or cement concrete sidewalk complete in place and accepted. The unit of measurement will be square meter.

16.8.3.4.2 Payment

The quantity as determined above, shall be paid for at the contract unit price per square meter for the pay items listed below and shown in the Bill of Quantities, which price and payment shall constitute full compensation for furnishing and placing all materials, for Portland Cement concrete, expansion joint material, for excavating and compacting the foundation bed, for furnishing and placing any crushed brick, gravel or other porous bed course material, for forms, and for all labour, equipment, tools and incidentals necessary to complete the item.

Pay Item No.	Description	Unit of Measurement
--------------	-------------	---------------------

16.8.3.4.2.1	Asphalt Concrete Sidewalk	(m ²)/100 sft.
16.8.3.4.2.2	Cement Concrete Sidewalk	(m ²)/100 sft.
16.8.3.4.2.3	Precast Concrete Sidewalk	(m ²)/100 sft.
16.8.3.4.2.4	Precast Concrete Interlocking Block Sidewalk	(m ²)/100 sft.

16.8.4 Metal Beam Guard Rail

16.8.4.1 Description

This Section shall consist of metal beam Guard rail constructed in accordance with these specifications at the locations and in conformity with the dimensions and design shown on the Drawings or as ordered by the Engineer.

16.8.4.2 Material Requirements

16.8.4.2.1 Metal Beam Guard Rail

The rail elements shall be galvanized corrugated steel beam conforming to the requirements of AASHTO M 180 of the designated type and class.

The mechanical properties of the base metals for beams shall conform to the following requirements: -

Yield Point	3500 kg/cm ² (50,000 Psi) minimum
Tensile Strength	4900 kg/cm ² (70,000 Psi) minimum
Elongation	Not less than 12 percent in a 5.08 cm (2 inch) gage length when tested in accordance with ASTM E 8

Table 81, Mechanical Properties of the Base Metals for Beams

In addition to the above the rail shall withstand a cold bend, without cracking of 180° around a mandrill of a diameter equal to 2 ½ times the thickness of the plate.

16.8.4.2.2 End of Buffer Sections

The end or buffer sections shall be formed from open health, electric furnace or basic oxygen steel. The section shall be of the same or superior class and type used for the beam to which it is attached. The size of the end or buffer section shall be according to the details given on the drawings or as directed by the Engineer.

16.8.4.2.3 Connections and Splices

All connections or splices shall be formed with oval shoulder button headed bolts to minimize projections on the side of the guardrail. All bolts and nuts for beams shall conform to or exceed the requirements of ASTM A307 and shall be galvanized as specified in ASTM A 153. The bolted connection of the rail element to the post shall withstand a 2270 kg (5000 lbs.) pull at right angles to the line of the railing.

16.8.4.2.4 Guardrail Posts

Posts shall be of either steel or concrete as specified. Only one type of post shall be used for any one continuous guardrail, except at junctions between bridges and embankments: -

- Steel posts shall be galvanized and of the section and length specified or
- as shown on the drawings. They shall conform to the requirements of AASHTO M 183 for the grade specified.
- Pre-cast reinforced concrete posts shall be of a section and length as specified or as shown on the drawings. The concrete shall be Class C as specified under 7-1. Reinforcement shall conform to the requirements of AASHTO M31 or M53. All bars shall be of the deformed type, conforming to AASHTO M 31 or M 42.

16.8.4.2.5 Wooden Spacer Blocks

Wooden spacer blocks between the guard rail and the posts shall conform to AASHTO M133 and M168 and be constructed to the section and length specified or as shown on the Drawings.

16.8.4.2.6 Post Foundation Blocks

- Where required or as ordered by the Engineer, post foundation blocks shall be constructed in Class A cement concrete as specified under 'Concrete' to the size shown on the drawings.
- In order to facilitate the removal of posts damaged by vehicle impact, posts shall be set in galvanized tubular steel sockets cast into foundation blocks. The sockets shall be of internal dimension (s) after galvanizing such that there is a clearance of 3 to 5mm/1/8" to 1/4" between the socket and the guard rail post. Following erection of guard rails, the space between posts and sockets shall be filled with epoxy mortar.

16.8.4.3 Construction Requirement

All posts shall be set vertically in the position shown on the drawings and where embedded in a concrete foundation block shall remain undisturbed for a minimum of 48 hours. The space around the posts shall be backfilled to the ground line, with selected earth containing no rocks, in layers of not exceeding 10 cm (4 inches) and each layer shall be moistened and thoroughly compacted. Where steel posts are driven into the ground no buckled post or deformed head shall be accepted.

16.8.4.3.1 Erection of Rail

All metal work shall be fabricated in the shop and no cutting or welding shall be done in the field unless otherwise ordered by the Engineer. Rail elements shall be lapped so that the exposed ends will not face approaching traffic. terminal sections shall be installed in accordance with the manufacturer's recommendation or as shown on the drawings or as directed by the Engineer.

16.8.4.4 Measurement and Payment

16.8.4.4.1 Measurement

- The guardrail shall be measured by the linear meter/feet from center to center of end posts for each completed section fastened in place and accepted.
- Post for guardrail and end or buffer sections for guardrail shall be measured by the number erected in place and accepted. Post foundation blocks provided, if required, shall not be paid separately.

16.8.4.4.2 Payment

The quantities determined as prescribed above shall be paid for at the contract unit price for the pay item listed below and shown in the Bill of Quantities which price shall be full compensation for furnishing, placing all materials, for foundations, for provision and erection of posts, for excavation and backfill, for installation and fastening, and for all costs including labour, tools and incidentals necessary to complete the work prescribed in this Section. Payment shall be made under: -

Pay Item No.	Description	Unit of Measurement
16-92-a	Metal Guardrail	M/Rft.
16-92-b	Guardrail end or Buffer Sections	Each
16-93-b	Concrete Post for Guardrail	Each
16.92-c	Steel Post for Guardrail	Each

16.8.5 Cement Concrete Beam Guardrail

16.8.5.1 Description

This section shall consist of cement concrete beam guardrail constructed in accordance with these specifications at the locations and in conformity with dimensions, and design shown on the drawings or as directed by the Engineer.

16.8.5.2 Material Requirements

16.8.5.2.1 Concrete Beam Guardrail

The rail shall be of Class A cement concrete as specified under 'Concrete'. Reinforcing steel shall conform to requirements of 16.6.9 'Steel Structure'. Concrete beam Guard rail shall be of size 125mm x 300mm/5" x 12" whereas reinforcing steel shall be provided at the rate of 120Kg/m³/7.5 lbs. per cft.

16.8.5.2.2 Guardrail Posts

- Post shall be of concrete Class A as specified in 'Concrete' of these specifications.
- Precast reinforced concrete posts shall be 250mm x 250mm. The concrete shall be class A as specified in 'Concrete'. Reinforcement shall conform to the requirements of AASHTO M31 or M53. All bars shall be of the deformed type, conforming to AASHTO M137. Reinforcing Steel shall be provided at the rate of 120Kg/cm³/7.5 lbs per cft.

16.8.5.2.3 Connections and Splices

Bolts, nuts, washers, sleeves and other fittings shall conform to ASTM Designation A 325(AASHTO M614) and shall be zinc coated in accordance with the requirement of ASTM Designation A 153 (AASHTO M 232).

16.8.5.2.4 Post Foundation Blocks

Where required, post foundation blocks, shall be constructed in Class C concrete as specified under 'Concrete' to the size shown on the drawings.

16.8.5.3 Construction Requirement

16.8.5.3.1 Form Work

Formwork shall be supplied and fixed in the position required for the concrete to be cast as shown on the Drawings. or as required by the Engineer, and shall be supplied erected and removed.

16.8.5.3.2 Steel Reinforcement

Steel reinforcement shall be furnished. bent and fixed where shown on the Drawings, or where required by the Engineer and its furnishing. bending and fixing shall be in accordance with 'Steel reinforcement'.

16.8.5.3.3 Concrete

Concrete Class D1 as shown on the Drawings or as required by the Engineer shall be supplied, placed, finished and cured as specified in 'Concrete'.

16.8.5.4 Measurement and Payment**16.8.5.4.1 Measurement**

- The guardrail shall be measured by the number from center to center of end posts for each completed unit in place and accepted.
- Guardrail end pieces shall be measured by the length completed in place and accepted. Posts for guard rail and guard rail end pieces shall be measured by the number erected in place and accepted.

16.8.5.4.2 Payment

The quantities, determined as prescribed above shall be paid for at the contract price per unit of measurement for the pay item listed below and shown in the Bill of Quantities which price shall be full compensation for furnishing, placing all materials, for foundations, for provision and erection of posts, for excavation and backfill, for installation and joining with mortar, and for all costs including labor, tools and incidentals necessary to complete the work prescribed in this item.

Pay Item No.	Description	Unit of Measurement
16.8.5.4.2.1	Concrete Beam Guardrail, Type	Per meter/Rft
16.8.5.4.2.2	Guardrail End Pieces, Type	Per meter/Rft
16.8.5.4.2.3	Concrete Post for Guard Rail and Guard Rail End Pieces, Type.	Each

16.8.6 Bridge Railing**16.8.6.1 Description**

This work consists of the supply and erection of concrete railing for bridges and other structures in accordance with these specifications and to the details shown on the Drawings. Where metal beam Guardrails form part of the Bridge Railing, the Guard rail beam and connections shall conform to the requirements of 16.8.4 'Metal Beam Guard Rail' and shall be paid for under that section.

16.8.6.2 Material Requirements**16.8.6.2.1 Formwork**

Formwork where necessary, shall conform to 16.6.5.

16.8.6.2.2 Steel Reinforcement

Steel reinforcement shall be as specified in 16.6.6 'Steel Reinforcement'.

16.8.6.2.3 Concrete

Concrete shall be class D1 as specified in 'Concrete' or as shown on the Drawings.

16.8.6.3 Construction Requirement**16.8.6.3.1 Formwork**

Formwork shall be supplied and fixed in the position required for the concrete to be cast as shown on the Drawings, or as directed by the Engineer, and shall be supplied, erected and removed as specified in 16.6.7 'Prestressed Concrete Structures'.

16.8.6.3.2 Steel Reinforcement

Steel reinforcement shall be furnished, bent and fixed where shown on the drawings or where directed by the Engineer and its furnishing, bending, and fixing shall be in accordance with the 16.6.6 'Steel Reinforcement'.

16.8.6.3.3 Concrete

Concrete class D1 as shown on the drawings or as directed by the Engineer shall be supplied, placed, finished and cured, as specified in 'Concrete'.

16.8.6.4 Measurement and Payment**16.8.6.4.1 Measurement**

Railing should be measure in running feet and shall be paid according to the specified item of MRS.

16.8.6.4.2 Payment

Payment shall be made for the materials utilized, or the rates quoted by contractor and measured as provided above, for following items.

Pay Item No.	Description	Unit of Measurement
16.8.6.4.2.1	RCC Bridge Railing	Running feet

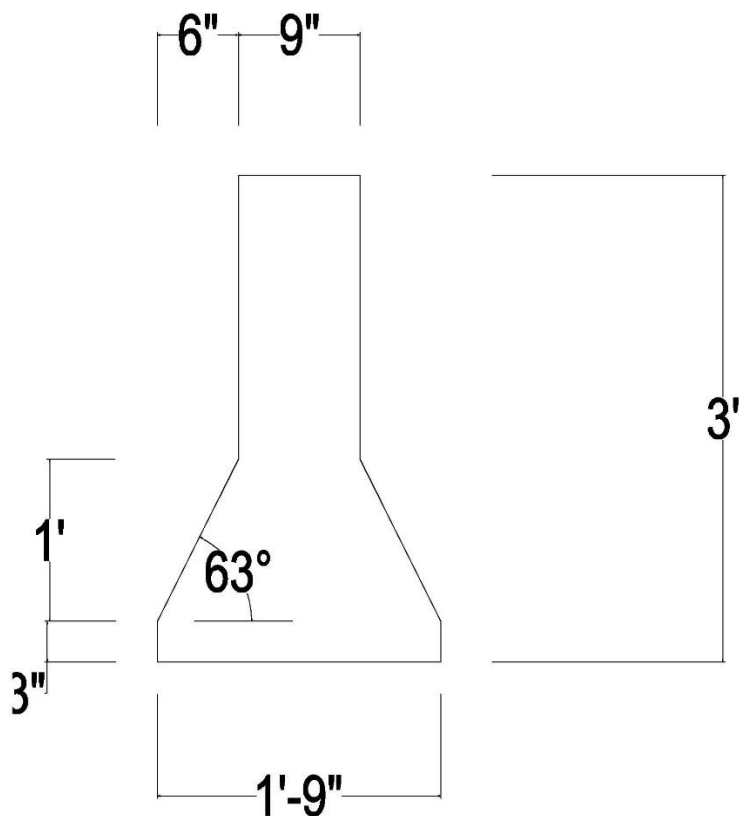

Figure 1 Typical Cross Section of RCC Bridge Railing

16.8.7 Traffic Road Signs and Safety Devices

16.8.7.1 Description

This work shall comprise furnishing and installing traffic signs, permanent safety devices and post assemblies in accordance with these specifications and to the details shown on the Drawings. All sign faces and lettering shall be in accordance with NHA (National Highway Authority) / NTRC (National Transport Research Center) sign standards or as shown on plans. Prior to manufacture and fabrication of the signs the contractor shall submit to the Engineer for approval detailed drawings showing letter sizes, traffic symbols and sign layout. The permanent safety devices shall consist of road. Posts and hazard markers and will be provided as per specifications drawings or as directed by the Engineer.

16.8.7.2 Material Requirements

16.8.7.2.1 Sign Panels

- Sign panels for regulator, warning and informatory signs shall be manufactured from aluminum alloy conforming to ASTM B 209, Alloy 6061-T6 or 5052-H38 plates of three (3) 1/8" mm thickness as shown on the drawings.
- The blanks shall be free from laminations, blisters, open seams, pits, holes, or other defects that may affect their appearance or use. The thickness shall be uniform and the blank commercially flat. Perform shearing, cutting and punching before preparing the blanks for application of reflective material.

- The blanks shall be cleaned, degreased, and chromate or otherwise properly prepared according to methods recommended by the sheeting manufacturer.

16.8.7.2.2 Reflective Sheeting

- Reflective sheeting used on road sign made of flexible white or colored, wide angle retroreflective sheeting (herein after called sheeting), and related processing materials designed to enhance nighttime visibility. The sheeting shall consist of optical elements adhered to a synthetic resin and encapsulated by a flexible transparent plastic that has a smooth outer surface.
- The sheeting shall have either a pre-coated pressure sensitive adhesive or a tack free adhesive activated by heat applied in a heat vacuum applicator in a manner recommended by the sheeting manufacturer. Both adhesive classes shall be protected by an easily removable liner.
- The manufacturer of the sheeting being offered furnish the process links, clears and thinners produced by the sheeting manufacturer recommended for and compatible with the sheeting to meet the performance requirements of it is specification and shall further be responsible, for technical assistance in the use of these inks or alternatively sheeting can be used on sheeting.
- The sheeting manufacturer must provide documented evidence to the satisfaction of the Engineer that representative production of material of the type to be supplied has been used successfully in a substantial traffic signing program in similar climatic condition for at least three years.
- **Color Requirements:** Color shall be specified and conform to the requirements of table below.

Color	X	Y	X	Y	X	Y	X	Y	Min	Max	Paper
White	0.30 3	0.28 7	0368	0.35 3	0.34 0	0.380	0.27 4	0.31 6	27. 0	.	5PB 7/1
Yellow	0.49 8	0.41 2	0.55 7	0.44 2	0.47 9	0.520	0.43 8	0.47 2	15. 0	40.0	1.25Y 6/12.
Red	0.61 3	0.29 7	0.70 8	0.29 2	0.63 6	0.364	0.55 8	0.35 2	2.5	11.0	7.5R 3/12
Blue	0.14 4	0.03 0	0.24 4	0.20 2	0.19 0	0.247	0.06 6	0.20 8	1.0	10.0	5.8PB 1.32/6. 8
Orange	0.55 0	0.36 0	0.63 0	0.37 0	0.58 1	0.418	0.51 6	0.39 4	14. 0	30.0	2.5YR 5.5/14
Brown	0.43 0	0.34 0	0.43 0	0.39 0	0.55 0	0.450	0.61 0	0.39 0	3.0	9.0	5YR 3.6
Green	0.30	0.38 0	0.66	0.34 6	0.28 6	0.428 8	0.20 1	0.77 6	3.0	8.0	10G 3/8

Table 82, Color Specification Limits and Reference Standards

1. Coefficient of Retroreflection

The coefficients of retro reflection shall conform to the minimum requirements of Table below.

Observation Angle (°)	Entrance Angle (°)	White	Red	Yellow	Green	Blue	Brown	Orange
0.2	-4	250	45	170	45	20.0	12.0	100.0
0.2	+30	150	25	100	25	11.0	8.5	60.0
0.5	-4	95	15	62	15	7.5	5.0	30.0

0.5	+30	65	10	45	10	5.0	3.5	25.0
-----	-----	----	----	----	----	-----	-----	------

Table 83, Minimum Coefficient of Retroreflection (Candelas per foot Candle per Square Foot)

- For screen printed transparent colored areas on white sheeting, the coefficients of retroreflection shall not be less than 70% of the values for corresponding color in the Table above.
- The sheeting manufacturer shall provide a test report from British Standards Institution (BSI) or any internationally recognized laboratory stating that the sheeting meets the requirements according to BSI 873 Part 6 or FP 92 of FHWA.
- The brightness of the reflective sheeting totally wet by rain shall be at least ninety (90) % of the above values.
- The reflective sheeting shall be sufficiently flexible as to permit application over and adhesion to a moderately embossed surface. It shall not show damage when bent ninety (90) degree over a fifty (5.0) mm/1/4" diameter mandrill.
- The sheeting shall show no cracking or reduction in reflection after being subjected to the dropping of a twenty-five (25) mm/1" diameter steel ball from a height of two (2) meters/6'-6" onto its surface.
- For heat activated material the adhesive shall permit the reflective sheeting to adhere securely forty-eight (48) hours after application, a temperature of up to ninety (90°) degree Centigrade.
- The reflective material shall be weather resistant and following cleaning, shall show no definite fading, darkening, cracking, blistering or peeling and not less than seventy-five (75%) percent of the specified wet or dry minimum brightness values when exposed to weathering for five (5) years.

2. Performance Requirements and Obligation

- The sign manufacturer shall submit a certificate from the sheeting manufacturer stating that the sheeting used for finished retroreflective signs meets all requirements listed herein.
- The retro reflective sheeting will be considered unsatisfactory if it has deteriorated due to natural causes to the extent that (1) the sign is ineffective for its intended purpose when viewed from a moving vehicle under normal day and night driving conditions; or (2) the coefficient of retroreflection is less than the minimum specified for that sheeting during that period listed in below.

Sheeting Color	Minimum Coefficient of Retroreflection (7 Years)	Minimum Coefficient of Retroreflection (10 Years)
White	212	200
Yellow	144	136
Green	38	36
Red	38	36
Blue	17	16
Brown	10	9

Table 84, Minimum Coefficient of Retroreflection Candelas Per Foot Per Square Foot (0.2" Om and 4" Entrance) %

For screen printed transparent colored areas on white sheeting, the coefficients of retroreflection shall not be less than 50% of the values for the corresponding color in the above table. All measurements shall be made after sign cleaning according to sheeting manufacturer's recommendations. Where it can be shown that retroreflective traffic signs supplied and used according to the sheeting manufacturer's recommendations have not met the performance requirements above the sheeting manufacturer shall cover restoration costs as follows for sheeting's shown to be unsatisfactory during.

- The entire seven years the sign manufacturer and sheeting manufacturer will replace the sheeting required to restore the sign surface to its original effectiveness.
- In addition, during the first five years sign manufacturer and sheeting manufacturer will cover the cost of restoring the sign surface to its original effectiveness at no cost to the NHA for materials and labor.

Samples of the reflective sheeting shall be approved by the Engineer prior to the Contract or placing his order.

16.8.7.2.3 Metal Posts

- Wide flange of 10 x 10 centimeters/4"x4" metal posts shall be fabricated from structural steel conforming to the Specifications of ASTM A 283 Grade D.
- In lieu of wide flange steel posts the Contractor may use tubular steel posts of minimum internal and external diameters of sixty-three (63) mm/2-1/2" and seventy-five (75) mm/3" respectively conforming to the specifications of ASTM A 501.
- All posts shall be thoroughly cleaned, free from grease, scale and rust, and shall be given one coat of rust inhibitive priming paint and two coats of grey paint. Length of the posts shall be such that their top flushes with the top of the sign panel, whereas bottom of sign panel is at least hundred and eighty (180) centimeters/7" above shoulder level.

16.8.7.2.4 Plates

- Plates shall be non-porous, smooth, flat, rigid, weather proof and shall not rust or deteriorate otherwise. It shall be so cut that there are no sharp edges and that the corners are rounded off to a radius of thirty-seven and half (37.5) mm/1.5". Any trade mark or other printing shall be carefully removed with liquid thinner.
- High Intensity Grade sheeting for the background should cover the whole area of the sign plate.
- Prior to application of the High Intensity Grade reflective sheeting, the sign, plate shall be cleaned and shall be wax free. They shall be degreased by vapor or by alkaline immersion and etched by scrubbing with abrasive cleaner. The plate shall be rinsed thoroughly and dried with hot air before applying the sheets.
- The sheeting after application to the sign base shall not come off the edges, which shall be sealed, nor shall it peel off nor warp. The surface shall be smooth and free from any bubbles, pimples, edge chipping or edge shattering. It shall be washable and weather proof.

16.8.7.2.5 Nuts and Bolts

All Nuts and bolts and metal washers shall be of heavily galvanized quality ten (10) mm die (G.I) or aluminum alloy. The bolt head to be such that they do not protrude out too much not show very, much on the front face of the plate a head should be flush with the plate face and covered with sheeting galvanized according to ASTM A 153.

16.8.7.2.6 Rubber Washer

All rubber washers shall have thick walls and shall not get dry and brittle when exposed to weather at the site after they are in position during the life of the sign.

16.8.7.2.7 Caps over the pipes

These can be of heavy plastic or of aluminum well fitted so that they cannot be removed; any good adhesive can be used.

16.8.7.2.8 General

- Very large signs need not be made of one piece; in that case extended Aluminum panels shall be used or the various pieces of sheet shall be joined by angle irons in anti-corroding materials, and, if necessary, with connecting cross pieces in order to ensure the solidity of the joint and with slanting struts embedded in the concrete as directed by the Engineer.
- All the nuts and bolts and metal washers must be heavily galvanized, or may be of stainless steel of high quality.
- Relevant holes to receive ten (10) mm bolts shall be drilled into the pipes and the plates and not punched. These are to be drilled through the plates before the application of scotch lite.
- After the plates are fixed with nuts and bolts, the nuts shall be Tack Welded to the bolts against pilferage.

16.8.7.2.9 Concrete Foundation Blocks

The concrete for the foundation blocks shall be in situ Class and shall of the size 450 x 450 x 650 mm/18"x18"x26" for category 1 & 2 and 600 x 600 x 750 mm/24"x24"x30" for category 3.

16.8.7.2.10 Road Posts and Hazard Markers

The road posts and hazard markers used as permanent safety devices shall conform fully, with the requirements of the statutory instruments, current British standards and chapter four (4) of the Traffic signs manual. The safety devices shall consist of delineators and detours of verge master, flex master, edge master, passing place post, and chevroflex etc. and will be manufactured from highly durable tough plastic material with standing vehicular impact. These shall be of High Intensity Grade reflective sheeting for maximum visibility by both day and night and consequently be resistant to impact, damage and vandalism.

16.8.7.3 Construction Requirement

16.8.7.3.1 Excavation and Backfill

- Holes shall be excavated to the required depth of the bottom of the concrete foundation as shown on the Drawing.
- Backfilling shall be carried out by using the surplus excavated material if approved by the Engineer and shall be compacted in layers not exceeding fifteen (15) cm/6" in depth.
- Surplus excavated material shall be disposed of by the Contractor as directed by the Engineer.

16.8.7.3.2 Erection of Posts

The posts shall be erected vertically in position inside the formwork of the foundation block prior to the placing of the concrete and shall be adequately supported by bracing to the prevent movement of the post during the setting process of the concrete. The posts shall be located at the positions shown on the Drawings.

16.8.7.3.3 Sign Panel Installation

- Sign panels shall be installed by the Contractor in accordance with the details, shown on the Drawings. Any chipping or bending of the sign panels shall be considered as sufficient cause to require replacement of the panels at the Contractor's expense.
- The exposed portion of the fastening hardware on the face of the sign shall be painted with enamels matching the background color
- All newly erected traffic road signs shall be covered with burlap or other material until their uncovering is ordered by the Engineer.

16.8.7.3.4 Categories of Signs

Traffic road signs shall be of three categories according to type of construction.

1. Warning Signs

Constructed with single post and sign of equilateral triangle shape, as shown in drawings, category 1.

2. Regulatory Signs

Constructed with single post and sign of circular shape, as shown in the drawings, category 2.

3. Informatory Signs

These signs shall be rectangular in shape and constructed with one, two or three numbers of posts or as shown on the drawings Dimensions may vary" according to the requirements, however total area of sign shall be as under: -

- Category 3 a = One Sq meter/10 sft.
- Category 3 b = Two Sq meter/20 sft.
- Category 3 c = As shown on drawings

4. Additional Panel

If any panel is required to be installed, it shall be of the sizes 60x30 cm/24"x12" or 90x30 cm/36"x12".

16.8.7.3.5 Installation of Safety Devices

Safety devices comprising of road posts, delineators of various types, fixed / portable safety barriers and hazard markers e.g. verge master, flex master chevreflex, bigmax, edgemaster and passing place post and other etc., shall be installed in accordance with the techniques and methods laid down in the manufacturer's manual or guide and in conformity to the line and level and locations shown on the drawings or as directed by the Engineer to ensure maximum visibility and safety, even in adverse weather conditions. These shall be constructed strictly with the specifications and full assistance by the manufacturer for installation with precision. These safety devices shall be used as delineators at sharp curves of highways verges, high embankments, culverts, bridges, as a visual and physical deterrent for a prohibiting car parking on grass verges and protecting herb side areas on public and private roads.

16.8.7.3.6 Sign faces**1. Design**

All sign faces shall be of the type, color, design and size as shown in the plans. Size and spacing of letters shall be as under: -

1	The Urdu writing shall be in "Persian" characters.	
2	The Urdu and English writing shall be about the same in length, width and spacing	
3	English letters are to be in italics except the first letter of the word, which shall be in capital.	
4	Height of Capital letters	21 cm/9"
5	Height of italics Letters	17 cm/7"
6	Stroke Width and Width of border	3.5 cm/1-1/2"
7	Space between words and border (at least)	5cm/2"
8	Space between Words	5 cm/2"
9	Space one line will occupy	4 cm/1'1/2"
10	Space between digits of numerals	4 cm/1-1/2"
11	Height of numerals same as capital letters	
12	Space between lines (at least)	
13	Size of letter for km. Height	K-23 cm/9" m-8 cm/3"
14	Width of letters for km including spacing	K-8 cm/3" m-9.6 cm/4"
15	Width of dividing line	2.0 cm/3/4"
16	The size and spacing for Urdu letter and Words will generally conform to the dimensions shown above for English letters.	
17	The spelling of place names in Urdu and in English shall be as written in the Survey of Pakistan, maps.	

Table 85, Size and Spacing of letters

2. Shop Drawings

The contractor shall submit to the Engineer for approval, three (3) copies of drawings for all special sign faces and all sign faces bearing messages, showing the design and/or arrangement and spacing of both the Urdu and English sign messages. Official town names and their spelling shall be as provided by the Engineer. Size and style of lettering shall be as shown on the plans or as otherwise approved by the Engineer.

16.8.7.3.7 Storage of Signs

Signs delivered for use on a project shall be stored off ground and under cover in a manner approved by the Engineer. Any signs damaged, discolored, defaced during transportation, storage or erection shall be rejected.

16.8.7.4 Measurement and Payment**16.8.7.4.1 Measurement**

The quantities of traffic road signs and safety devices to be paid for shall be measured in number of each category of sign supplied and installed at site as directed by the Engineer.

16.8.7.4.2 Payment

The quantities measured as determined above shall be paid for at the contract unit price for the pay items listed below and as shown in the Bill of Quantities which price and payment shall be full compensation for furnishing all labor, materials, tools, equipment, and for excavation, concreting, backfilling and erection of posts, installation of sign panels and all incidental costs including sheeting/painting necessary to complete the work as prescribed in this Section.

Pay Item No.	Description	Unit of Measurement
16-20-a	Traffic Road Signs Category 1, size	Each
16-20-b	Traffic Road Signs Category 2, size	Each
16-20-c	Traffic Road Signs Category 3 (a)	Each
16-20-d	Traffic Road Signs Category 3 (b)	Each
16.8.7	Traffic Road Signs Category 3 (c)	SM/Sft
16.8.7	Additional panel size 60 x.30 cm/24"x12"	Each
16.8.7	Additional panel size 90 x 30 cm/36"x12"	Each
16.8.7	Road Posts and Hazard Markers	Each

16.8.8 Pavement Marking

16.8.8.1 Description

The work shall consist of furnishing non-reflective or reflective chlorinated rubber based thermoplastic paint material or retroreflective performed pavement marking (tape) whichever is called for in the Special Provisions and shown in the Bill of Quantities, for sampling and packing for the preparation of surface all in accordance with these Specifications. The paint shall be applied in accordance to the size, shape and location of the markings as shown in the Drawings.

16.8.8.2 Chlorinated Rubber Paint

16.8.8.2.1 Material Requirements

A standard and acceptable quality of Chlorinated Rubber based paint shall be used. The paint shall be homogeneous, well dispersed to smooth consistency and shall not cake, live, thicken curdle, gel, settle badly or show any other objectionable properties after period of storage not to exceed six (6) months.

1. Composition

i)	Pigment	Titanium dioxide Rutilite and Extenders	100 %
ii)	Vehicle	Modified Chlorinated Rubber Plasticized and Resin Blend	52 ± 4%
		Solvents	45 ± 4%
		Additives: i.e. Flow leveling, adhesion improving agents, anti-oxidants, siccatives etc.	1-3%
iii)	Paint Composition	Pigments	55 ± 4 %
		Vehicle Solvent and additives	45 ± 5 %

Table 86, White Traffic Paint Requirements

i)	Pigment	Chrome Yellow and Extenders	100% by Weight
ii)	Vehicle	Same as for white traffic paint	
iii)	Paint Composition:	Pigments	55±4% by Weight

	Vehicle, Solvent and Additives	45+5% by Weight
--	--------------------------------	-----------------

Table 87, Yellow Traffic Paint Requirements

i)	Pigment	Chrome Yellow and Extenders	100% by Weight
ii)	Vehicle	Same as for white traffic paint	
iii)	Paint Composition:	Pigments	55±4% by Weight
		Vehicle, Solvent and Additives	45±5% by Weight

Table 88, Black Traffic Paint Requirements

- The volatile material shall be of such character that has a minimum solvent action of asphalt, and such that the resins and nonvolatile components will be entirely dissolved in the volatile material, and will not precipitate from the solution on standing. The non-volatile material shall be of such quality that it will not darken or become yellow when a thin section is exposed to the sunlight.
- Other pavement marking paint may be submitted by the Contractor as an alternative to the above, for the approval of the Engineer.

16.8.8.2.2 Ballotini for Reflective Road Paint

The grading of balloting dispersed in the paint shall be as follows in Table below.

Sieve Sizes	Percentage Retained
No. 12	0
No. 20	30
No. 30	50
No. 50	80
No. 80	100

Table 89, Ballotini for Reflective Road Paint

- Glass beads shall conform to AASHTO Designation M-247 At least ninety (90) percent glass beads shall be transparent, reasonable spherical and free from flaws.
- The proportion of balloting to paint shall be not less than five hundred (500) grams per litre of paint.

16.8.8.2.3 Photometric Requirements for Reflective Road Paint

Other reflective road paints may be considered for use by the Engineer provided they have minimum brightness values at two tenth (0.2) degree and half (0.5) degree divergence expressed as candle power per meter per requirement surface Coating as follows in Table below.

		Color			
		White		Yellow	
Divergence Angle	(Degree)	0.2	0.5	0.2	0.5
Incidence Angles	4(Degree)	237	118	129	75
Incidence Angles	40(Degree)	75	43	43	32

Table 90, Photometric Requirements for Reflective Road Paint

16.8.8.2.4 Construction Requirement

- Traffic markings shall be applied with approved equipment capable of applying the paint at the specified width and at the specified rate of application. In no case shall the contractor proceed with the work until the equipment, method of application and rate of application as established by a test section have been approved by the Engineer

- The painting of lane markers and traffic strips shall include the cleaning of the pavement surfaces, the application, protection and drying of the paint coatings, the protection of pedestrians, vehicular or other traffic on the pavements, the protection of all parts of the road, structures or appurtenances against disfigurement by spatters, splashes or smirches of paint or of paint materials, and the supplying of all tools, labor and traffic paint necessary for the entire work.
- The paint shall not be applied during rain, wet weather, when the air is misty, or when, in the opinion of the Engineer, conditions are otherwise unfavorable for the work. Paint shall not be applied upon damp pavement surfaces, or upon pavements which have absorbed heat sufficient to cause the paint to blister and produce a porous paint film.
- The application of paint shall preferably be carried out by a purpose made machine but where brushes are used only round or oval brushes not exceeding 10 cm. in width will be permitted. The paint, when applied, shall be so applied as to produce a uniform, even coating in close contact with the surface being painted.
- Traffic paint shall be applied to the pavement at a rate of one (1) litre to two and half (2.5) square meters or less. Contractor shall provide adequate arrangements that applied paint is not disfigured by moving, traffic, till its complete drying and sticking to road surface.

16.8.8.3 Hot Applied Thermoplastic Road Paints

16.8.8.3.1 Material Requirements

1. Aggregate

The aggregate shall consist of light-colored silica sand, calcite, quartz, calcined flint or other material approved by the Engineer.

2. Pigment and Extender

a. White Material

The pigment shall be titanium dioxide complying with the requirements of Type A (anatase) or Type R (rutile) of BS EN ISO 591-1:2000.

b. Yellow Materials

Sufficient suitable yellow pigment shall be substituted for all or part of the titanium dioxide to comply with the other requirements of this specification.

c. All Materials

The extender shall normally be whiting (i.e. calcium carbonate prepared from natural chalk) complying with the requirements of BS EN ISO 3262-13:1998. The manufacturer may substitute lithopone complying with the requirement of BS 296 for any or all of the whiting.

d. Binder

The binder shall consist of synthetic hydrocarbon resin, or, with the approval of the Engineer, gun or wood resin, plasticized with mineral oil.

e. Composition of mixture

The proportions of the constituents of the mixed material as found on analysis shall comply with the requirements of Table given below.

Constituent	Percentage by mass of total mixture	
	Minimum	Maximum
Binder (resin and oil)	18	22
Pigment	6*	--
Pigment and extender	18	22
Ballotini	20+	
Aggregate		--
Pigment Extender and ballotini	78	82

Table 91, Proportions of Constituents of Mixture

* For Titanium Di-oxide only, no minimum is specified for yellow material.

- Where specified, 10% in the case of material to which surface ballotini is to be applied by pressure application.

The grading of the combined aggregate, pigment, extender and ballotini (where specified) as found on analysis, shall comply with the requirements of Table below.

Sieve	Percentage by mass passing	
	Screeded	Sprayed
280 µm	100	100
600 µm	--	75–95

Table 92, Grading of Combined Aggregate, Pigment Extender and Ballotini

16.8.8.3.2 Sampling and Testing

1. Sampling

For the purpose of carrying out the testing, it is essential that adequate and representative samples be taken in the manner prescribed in specification BS 3262 at following stages.

- At the manufacturer's plant.
- After it has been re-melted by the road application contractor.

2. Testing

The samples shall be prepared and tested in accordance with B.S. Specification 3262 (1976) appendix A to H. The test results shall conform to the following properties

a. Softening Point

The softening point measured in accordance with appendix C shall be not less than 65° C.

b. Color and Luminance

i. White Material

The luminance factor of white material as delivered by the manufacturer shall be measured in accordance with appendix D and shall not be less than 70 whereas the luminance factor of material obtained from an applicator or melter on site after re-melting measured in accordance with appendix D shall not be less than 65.

ii. Yellow Material

The Color of yellow material shall be approximately BS 381C SET:1996(R2002) Color No. 355, Lemon. The luminance factor of yellow material as delivered by the manufacturer shall be not less than 60 whereas the luminance factor of material obtained from an applicator or melter on site after re-melting measured in accordance with appendix D shall not be less than 55.

c. Heat Stability**i. White Material**

When tested in accordance with appendix E, the luminance factor of white material as measured in accordance with appendix D shall be not less than 65

ii. Yellow Material

When tested in accordance with appendix E, the luminance factor of yellow material as measured in accordance with appendix D shall be not less than 55.

d. Flow Resistance

In testing the flow resistance, a cone made and tested in accordance with appendix F, shall not slump by more than 25%.

e. Skid Resistance

When tested in accordance with appendix G, the skid resistance of a newly laid marking prepared under the stated conditions shall be not less than 45.

16.8.8.3.3 Manufacturing, Packing and Storing of Paint**1. Manufacturing**

The paint shall be produced in a plant owned and operated by the manufacturer following a process which has been used by the manufacturer for at least five (5) years to produce paint. The equipment for mixing and grinding shall be clean, modern, and in good condition.

2. Packing

- The material shall be supplied in sealed containers which do not contaminate the contents and which protect them from contamination.
- Each container shall be clearly and indelibly marked with the manufacturer's name, Batch number, date of manufacture, reflectorizing (if applicable) color, chemical type of binder and maximum safe heating temperature.

3. Storing

The material shall be stored in accordance with the manufacturer's instructions and any material that is in damaged containers of which the seal has been broken, shall not be used.

16.8.8.3.4 Certification

The Contractor shall furnish a certificate from manufacturer that the material he proposes to use has the required properties, stating the maximum and minimum proportions and grading of the constituents, the acid value of the binder, the setting time, the maximum safe heating temperature, the temperature range of the apparatus and the proposed method of laying.

16.8.8.3.5 Application of Material to The Road

1. Preparation of site

The thermoplastic paint shall only be applied to surfaces, which are clean and dry. Immediately before the application of paint, the surface shall be cleaned with mechanical broom, compressed air or other approved means to remove surplus asphalt, oils, mud, dust and other loose or adhered material. The material shall not be applied if the road surface is at a temperature of less than 5°C.

2. Preparation of material on site

The material shall be melted in accordance with the manufacturer's instructions in heater fitted with a mechanical stirrer to give a smooth consistency to the thermoplastic material and such that local overheating will be avoided. The temperature of the mass shall be within the range specified by the manufacturer; and shall on no account be allowed to exceed the maximum temperature stated by the manufacturer. The molten material shall be used as expeditiously as possible and for thermoplastic material which of as natural resin binders or is otherwise sensitive to prolonged heating, the material shall not be maintained in a molten condition for more than 4 hours.

- After transfer to the laying apparatus, the material shall be maintained within the temperature range specified by the manufacturer and stirred to maintain the right consistency for laying.
- On concrete carriageway, a tack coat compatible with the marking material shall be applied in accordance with the manufacturer's instructions prior to the application of thermoplastic material.

3. Laying

Carriageway Centre lines, lane lines and edge lines shall be laid to a regular alignment by self-propelled machine. Other markings may be laid by hand, hand propelled machine or self-propelled machine as approved by the Engineer. The surface produced shall be uniform in texture and thickness and appreciably free from blisters and streaks.

4. Reflectorizing by surface application

When surface application of balloting is required, additional balloting (400 g/m² to 500 g/m² from the machine) shall be applied by pressure concurrently with the laying of the line with sufficient velocity to ensure retention in the surface of the line. The balloting so sprayed shall give uniform cover and immediate reflectivity over the whole surface of the marking. Balloting dispensed on the surface of the markings shall conform to the following grading as shows in Table below.

Sieve	Percentage by mass passing
1.7 mm/1/8"	100
600 µm	80-100
425 µm	45-100
300 µm	10-45

212 μm	0-25
75 μm	0-5

Table 93, Reflectorizing by Surface Application

Not less than 90%, by mass of the balloting, shall be of transparent glass, spherical in shape and not more than ten (10) percent shall be ovate in shape or have other flaws. The balloting shall be made of soda glass.

5. Thickness

Unless otherwise approved by the Engineer, the material shall be laid to the following thicknesses.

- Sprayed lines other than yellow not less than 1.5 mm.
- Sprayed yellow edge lines not less than 0.8 mm.

The minimum thicknesses specified are exclusive of surface applied balloting. The method of thickness measurement shall be in accordance with appendix H of BS 3262 (1976).

16.8.8.3.6 Trial Section

In no case shall the contractor proceed with the work until the equipment, method of application and rate of application conforming the required thickness (as established by a test section) have been approved by the Engineer.

16.8.8.4 Retro-Reflective Preformed Pavement Markings

16.8.8.4.1 Material Requirements

- The preformed markings shall consist of white or yellow films with pigments selected to conform to standard highway colors. Ceramic and glass beads shall be incorporated to provide immediate and continuing retroreflection. Ceramic skid particles shall be bonded to a top urethane layer to provide a skid resistant surface.
- The preformed markings shall be capable of being adhered to asphalt cement concrete (ACC) or Portland Cement Concrete (PCC) by a pre-coated pressure sensitive adhesive. A primer may be used to precondition the pavement surface. The preformed marking film shall mold itself to pavement contours by the action of traffic. The pavement marking film wearing courses during the paving operation shall be approved by the Engineer in accordance with the manufacturer's instructions. Following proper application and tamping, the markings shall be immediately ready for traffic. The bidder, when bidding; shall identify proper solvents and/or primers (where necessary) for proper application, and recommendation for application that will assure effective product performance. The preformed markings shall be suitable for use for one year after the date of receipt when stored in accordance with the manufacturer's recommendations.
- The marking film shall be durable retroreflective plisot polymer pavement marking film for performed longitudinal markings subject to low to medium traffic volumes and moderate wear conditions such as repeated shear action from crossover or encroachment on channelization lines.
- The retroreflective pavement marking film shall consist of mixture of high quality pigmented polymeric materials, with a reflective layer of ceramic and glass beads, and a layer of skid resistant ceramic particles bonded to the top urethane wear face, he film shall have a predated pressure Sensitive" adhesive. The edges of the preformed tape shall be clear cut and true.

16.8.8.4.2 Color

- The daytime color of the white film shall provide a minimum initial Luminance factor, Y, of 80, and shall conform to the following: chromaticity requirements: $X = 0.290$ $Y = 0.491$ $Z = 0.435$; $X = 0.512$ $Y = 0.486$; $X = 0.536$ $Y = 0.463$.
- Measurements shall be made in accordance with ASTM E 1349, using illuminant "C" and 0/45 (45/0) geometry. Calculations shall be in accordance with ASTM E 308 for the 2° standard observer.

16.8.8.4.3 Reflectance

The white and yellow films shall have the following initial minimum reflectance values as measured in accordance with the testing procedures 1M ASTM D 4061. The photometric quantity to be measured shall be specific luminance (SL), and shall be expressed as millicandals per square foot per foot candle (mcd. ft²). Fc⁻¹). The metric, equivalent shall be expressed as millicandals per square meter per lux (mcd. m²) lx⁻¹)

	White	Yellow
Entrance Angle 86.000	86.5°	86.5°
Observation Angle	1.0°	1.0°
Specific Luminance	300	175
SL (mcd. ff 2). fc		

Table 94, Reflectance

16.8.8.4.4 Skid Resistance

The surface of the retroreflective films shall provide the initial minimum skid resistance values of 55 BPN as measured by the British Portable Skid Tester in accordance with, ASTM E 303.

16.8.8.4.5 Patch Ability

The pavement marking film shall be capable of use for patching worn areas of the same type of film in accordance with the manufacturer's instructions.

16.8.8.4.6 Reflectance Retention

To have a good, effective performance life, the ceramic and glass beads must be strongly bonded and not be easily removed by traffic wear. The following test shall be employed to measure reflectivity retention.

16.8.8.4.7 Taber Abrader Simulation Test

Using a Taber Abraser with an H-18 wheel and a 125-gram load, the sample shall be inspected at 200 cycles, under a microscope, to observed the extent and type of bead failure No more than 15% of the treads shall be lost due to pop out and the predominant mode of failure shall be "wear down" on the beads.

16.8.8.4.8 Beads

The size, quality and refractive index of the ceramic and glass beads shall be such that the performance requirements for the marking shall be met. The bead adhesion shall be such that beads are not easily removed when the material surface is scratched.

16.8.8.4.9 Bead Retention

The film shall be ceramic and glass bead retention qualities such that when a 2 in x 6 in. (5.08 cm x 15.24 cm) sample is bent over a ½ in. (1.27 cm) diameter mandrel, with the 2 M dimension perpendicular to the mandrel axis. Microscopic, examination of the area on the mandrel shall show no more than 10% of the beads with entrapment by the binder of less than 40%.

16.8.8.4.10 Thickness

The film without adhesive shall have a minimum thickness of 0.030 in (0.76mm).

16.8.8.4.11 Effective Performance Life

The film, when applied according to the recommendations of the manufacturer, shall provide neat, durable marking that will not flow or distort due to temperature if the pavement surface remains stable. The film shall be weather resistant and through normal traffic wear shall show no fading, lifting or shrinkage which will significantly impair the intended usage of the marking throughout its useful life and shall show no significant tearing, roll back or other signs of poor adhesion.

16.8.8.4.12 Installation

The markings shall be applied in accordance with the manufacturer's instructions.

16.8.8.4.13 Cementations Marking Compound

Cementations marking compound shall be used for Concrete, Surface Dressing and Bitumen to provide enhanced night and wet, weather visibility. This compound will be applied at following locations: -

- Curbs Pavements and car park areas.
- Roundabout vertical and sloping faces.
- Traffic Islands vertical edges and bull noses, etc.
- Traffic Dividers black and white chevrons.
- Concrete wall and faces on high speed intersections and traffic merging.

16.8.8.14 Measurement and Payment

16.8.8.14.1 Measurement

- The quantity of non-reflective or reflective chlorinated rubber based or thermoplastic pavement marking paint shall be the no. of linear meters of painted: traffic line for the specified width as indicated in B.O.Q. The retro reflective preformed pavement markings (tape) shall be measured in square meters. The arrows shall be measured in number.
- The measurement shall be made of painted areas completed and accepted. No measurement shall be made of unauthorized areas. Paint that is applied in

unauthorized areas shall be completely removed from the surface of the road to the satisfaction of the Engineer and bf Contractor's expense.

16.8.8.14.2 Payment

The quantities measured as determined above shall be paid for at the Contract unit price respectively for the pay items listed below, which price and payment shall constitute full compensation for furnishing and placing all materials including sampling, packing and testing at approved laboratory. The cost shall also include the preparation of the surface, and for all other costs necessary to complete the work as prescribed in this Section.

Pay Item No.	Description	Unit of Measurement
16.8.8.14.2	Pavement Marking in non-reflective CR/TP Paint for Lines of 12 cm width.	M/Rft
16-79-g, j	Pavement Marking in non-reflective CR/TP Paint for Lines of 15 cm width.	M/Rft
16-79-h, k	Pavement Marking in non-reflective CR/TP Paint for Lines of 20 cm width.	M/Rft
16-79-m, n	Pavement Marking in non-reflective CR/TP Paint for 4.0. M arrows.	Each
16.8.8.14.2	Pavement Marking in non-reflective CR/TP Paint up to 6.0 M arrows.	Each
16.8.8.14.2	Pavement Marking in non-reflective CR/TP Paint for various signs.	SM/Sft
16-79-a	Pavement Marking in reflective CR/TP Paint for Line of 12 cm width.	M/Rft
16-78-a	Pavement Marking in reflective CR/TP Paint for Line of 15 cm width.	M/Rft
16-78-b & 16-79-c	Pavement Marking in reflective CRITP Paint of 20 cm width	M/Rft
16-79-b	Pavement Marking in reflective CR/TP Paint for 4 M arrows.	Each
16.8.8.14.2	Pavement Marking in reflective CR/TP Paint for various signs.	Each
16.8.8.14.2	Pavement Marking in reflective CRITP Paint for various signs.	SM/Sft
16.8.8.14.2	Pavement Marking by retro reflective Preformed pavement markings (Tape).	SM/Sft

16.8.9 Precast Concrete Posts and Markers

16.8.9.1 Description

The work shall consist of furnishing and placing precast concrete Kilometer, Ten Kilometer, Guide Post's and Right of Way Markers, complete including painting and lettering in accordance with the Drawings and specifications or as directed by the Engineer.

16.8.9.2 Material Requirements

16.8.9.2.1 Concrete

Precast concrete post and markers shall consist of Class conforming to the requirements of 'Concrete' and to the lengths, shapes and other details shown on the Drawings.

16.8.9.2.2 Reinforcing Steel

Reinforcing steel shall conform to 16.6.6 'Steel Reinforcement'.

16.8.9.3 Construction Requirement

16.8.9.3.1 Excavation and Bedding

- Excavation shall be made to the required depth as shown on the Drawings. All soft and unsuitable material shall be removed and replaced with suitable material acceptable to the Engineer.
- Bedding shall be to section and dimension shown on the Drawings or as directed by the Engineer.

16.8.9.3.2 Placing

The precast concrete posts and markers shall be set in two (2) cm/3/4" of cement mortar to the level and grade as shown on the Drawings or as directed by the Engineer.

16.8.9.3.3 Back filling

After the placing of precast concrete posts and markers in the excavated areas and subsequent setting in with cement mortar, the same will be refilled to the required elevation with suitable earth or 'granular material, which shall be tamped in layers of not more than fifteen (15) centimeters/6" each until firm and solid.

16.8.9.4 Measurement and Payment

16.8.9.4.1 Measurement

The quantity of each element to be paid for shall be the number of post and marker furnished and installed in place as per drawing or as directed by the Engineer: -.

16.8.9.4.2 Payment

In accepted quantities of posts and markers shall be paid for at the contract unit price per unit of measurement for the pay items listed below and shown in Bill of Quantities which price shall be compensation for furnishing, excavation, placing, erection, painting, lettering and for all costs including labor, tools, and incidentals necessary to complete the work prescribed in this section:

Pay Item No.	Description	Unit of Measurement
16.8.9.4.2	Guide Post.	Each
16-82-a	Right of Way Marker.	Each
16-82-b	Kilometer Post.	Each
16-82-c	Ten Kilometer Post.	Each

16.8.10 Reflectorized Pavement Studs**16.8.10.1 Description**

This section shall consist of furnishing and installing Reflectorized pavement studs set into the traveled way of the type in accordance with the specifications and at the locations shown on the Drawings or as directed by the Engineer.

16.8.10.2 Material Requirements**16.8.10.2.1 Reflectorized Studs**

Reflectorized Studs shall be "cat eyes" either the 'Flush Surface' type or 'Raised Profile' type having the following characteristics.

1. Flush Surface Type

- The 'Flush Surface' reflector shall be the short base type having a maximum base area of 18 cm x 14 cm/7x5-1/2" or as shown in the Drawings.
- The base shall be formed in cast iron with adequate webbing to ensure a firm key to the road when installed.
- The pad shall be highly resilient and durable rubber reinforced with canvas and shall have an anticipated life of at least five (5) years. The pad shall be so designed as to produce a self-whipping action of the reflector when depressed.
- The reflectors shall be made of impact and abrasion resisting glass and shall be hermetically sealed into a copper socket.

2. Raised Profile Type

- The 'Raised Profile' reflectors shall consist of an acrylic plastic shell filled with an adherent epoxy compound molded from methyl methacrylate into the shape of a shallow frustum of a pyramid having base dimension of approximately 10 cm x 10 cm and thickness not more than two (2) cm/3/4" or as shown on the drawings.
- The shell shall contain one or two prismatic reflector each inclined at an angle of thirty (30) degree to the horizontal and having an area not less than twenty (20) square cm or as indicated on the plans.
- The reflectors shall attain the following standards for their photometric and physical qualities:

a. Photometric Requirements

- The reflectors shall have the following minimum Specific Intensity values (S.I) expressed as candle power per foot candle of illumination at the reflector on a plane perpendicular to the incident light as shown in Table below.

	Colour		
	Crystal	Yellow	Red
Divergence Angle	0.20	0.20	0.20
(in Degree)	S. I	S. I	S. I
Incidence Angle			
0	3.00	1.80	0.75
20	1.20	0.72	0.30

Table 95, Photometric Requirements of Reflectors

- The reflector for testing shall be located with the center of the reflecting face at a distance of one and half (1.5) m from a uniformly bright light source having an effective diameter of half (0.5) centimeter.
- The width of the photocell shall be 1.27 cm and shall be shielded from stray light. The distance from the centers of the light source and photocell shall be 0.53 cm.
- Failure of more than four (4) % of the reflecting faces shall be cause for rejection of the lot.

ii. Strength Requirement

- The reflectors shall support a vertical load of 1000 kg/2240 lbs. when tested in the following manner.
- A reflector shall be centered horizontally over the open end of a vertically positioned hollow metal cylinder seventy-five (75) mm/3” internal diameter, twenty-five (25) mm/1” high and wall thickness of six (6) mm/1/4”. The load shall be applied to the top of the reflector through a six (6) mm/1/4” diameter by six (6) mm/1/4” high metal plug centered on top of the reflector.
- Failure shall constitute either breakage or significant deformation of the marker at any load less than one thousand (1000) kg/2240 lbs.

16.8.10.2.2 Adhesives

- When 'Raised Profile' type of reflectors are used, a two-part adhesive having the following ingredients shall be applied to the stud for bonding to the pavement surface shown in Table below.

Package A	Kg / Liter/Lbs/Gln.
Epoxy Resin	0.94/0.46
Titanium Dioxide	0.07/0.03
Colloidal Silica	0.05/0.02
Talc	0.345/0.17

Table 96, Adhesives Requirements Package A

Package B	Kg / Liter/Lbs./Gln.
Modified Asphaltic Amine Hardener (Reinhold 2611)	0.24/0.11
Modified Asphaltic Amine Hardener (Reinhold 2613)	0.472/0.23
Carbon Black	0.0022/0.001
Colloidal Silica	0.04/0.02
Talc	0.650/0.32

Table 97, Adhesive Requirements Package B

- Equal volumes of Package A & B should be mixed together until a uniform color is obtained. No more than one quart of adhesive shall be prepared at one time.

16.8.10.2.3 Cement Mortar.

Cement mortar shall consist of one (1) part Portland cement to three (3) parts of fine aggregates.

16.8.10.3 Construction Requirement

16.8.10.3.1 Flush Surface Type

- The stud shall be installed into the pavement in accordance with the manufacturer's instructions but shall also comply with the following requirements: -
- Cavities in the pavement shall be clearly cut to the dimension of the pavement stud and shall allow a clearance of one (1) cm/3/8" around the stud base. The longitudinal center line axis of the cavity shall be the same as that required for the pavement stud when laid to correct line and direction.
- The walls of the cavity shall be splayed back at an angle of approximately thirty (30) degree to the vertical to facilitate a "dove tail" joint after the mortar has set.
- The bottom of the cavity shall be leveled with asphalt concrete prior to placing the stud base which shall be pounded into position with Pounder Foot attached to a pneumatic drill.
- The depth of the cavity shall be such that when the stud base and reflectors have been installed the elevation of the floor of the lens shall be greater than two (2) mm or less than one (1) mm above the pavement surface:
- The stud shall be grouted into position with asphalt concrete containing fine aggregate only or with a cement mortar when the studs are installed into a cement concrete pavement.

16.8.10.3.2 Raised Profile Type

The pavement studs shall be installed in accordance with the manufacturer's instructions or to the requirements of the Engineer.

16.8.10.4 Measurement and Payment

16.8.10.4.1 Measurement

The quantity of reflectorized pavement studs to be paid for shall be the number of 'Flushed Surface' or 'Raised Profile' type provided and installed as mentioned above.

16.8.10.4.2 Payment

The quantities measured as described above shall be paid for at the contract unit price respectively for the pay items listed below and shown in the Bill of Quantities, which payment shall constitute full compensation for furnishing and placing all materials, excavating cavities, preparation of surfaces, applying adhesive and mortar, for all labor, equipment, tools and incidentals necessary to complete the work.

Pay Item No.	Description	Unit of Measurement
16-27	Reflectorized Pavement Stud, (Flush Surface Type - Single)	Each
16-27	Reflectorized Pavement Stud (Flush Surface Type - Double)	Each
16-27	Reflectorized Pavement Stud Raised Profile Type - Single)	Each
16-27	Reflectorized Pavement Stud (Raised Profile Type - Double)	Each

16.8.11 Fencing

16.8.11.1 Description

The work shall consist of constructing concrete or steel post and barbed wire fence or chain link fence in accordance with the details and at the locations shown on the drawings or as directed by the Engineer.

16.8.11.2 Material Requirements

16.8.11.2.1 Barbed Wire

Barbed wire shall conform to the requirements of (AASHTO M280) ASTM A 121, Class 1. The barbed wire shall consist of 2 strands of 12.5-gauge wire, twisted with 2 points, 14-gauge barbs spaced 10 cm (4 inch) apart.

16.8.11.2.2 Chain Link Fabric

Chain link fabric shall be fabricated from 10-gauge galvanized wire conforming to AASHTO M 181 and shall be of the type shown in the drawings. Before ordering the chain link fabric the Contractor shall submit a sample of the material to the Engineer in charge for his approval.

16.8.11.2.3 Concrete Posts

Concrete posts shall be made from Class D1 concrete in accordance with 'Concrete'. The posts shall be cast to the length shown on the drawings and shall have a smooth surface finish. Size of concrete post should be 6x6 inch and length of 8 feet.

16.8.11.2.4 Steel Posts

Steel posts shall be of the section and length as specified or as shown on the drawings. The posts shall be of copper bearing steel and shall conform to the requirements of AASHTO M 183 for the grade specified.

16.8.11.2.4.1 Steel Reinforcement for Concrete Posts

Steel reinforcement for the concrete posts shall be deformed steel bars conforming to the provisions of 16.6.6 'Steel Reinforcement'.

16.8.11.2.4.2 Hardware for Steel Posts

Nuts, bolts, washers and other associated hardware shall be galvanized after fabrication as specified in ASTM 153.

16.8.11.3 Construction Requirement

16.8.11.3.1 Erection of Posts

The posts shall be erected vertically in position, inside the formwork of the foundation block prior to the placing of the concrete and shall be adequately supported by bracing to prevent

movement of the post during the setting process of the concrete. The posts shall be erected to the height and at the locations shown on the drawings or as directed by the Engineer.

16.8.11.3.2 Installation of Chain Link Fabric or Fabric of Barbed Wire

- The chain link fabric or barbed wire shall be set to line and elevation and pulled tight between each post before spot welding or other method of fixing is carried out.
- Where splicing of the fabric is necessary or at joints the lapping of the chain link fabric shall be a minimum of 10 cm (4 inch) and shall occur only at the concrete post.
- No horizontal splicing will be permitted.
- The fabric shall be fixed to the concrete posts as shown on the drawings.

16.8.11.4 Measurement and Payment

16.8.11.4.1 Measurement

The quantity to be paid shall be measured in linear feet/meter and multiplied by its theoretical standard weight.

16.8.11.4.2 Payment

The quantities measured as determined above shall be paid for at the contract unit price for the pay items listed below and shown in the Bill of Quantities which price and payment shall be full compensation for furnishing, placing, excavating, backfilling and erecting all posts for the installation, fixing and welding of the fabric and wire and for all materials, labor, equipment, tools and incidentals necessary to complete the work.

Pay Item No.	Description	Unit of Measurement
16.8.11.4.2.1	Chain Link Fabric Fencing	KG/lbs.
16.8.11.4.2.2	Barbed Wire Fencing	KG/lbs.

16.8.12 Reflective Traffic Mirrors

16.8.12.1 Description

These specifications provide guidance on the use and installation of convex mirrors on public roads as a traffic safety device.

16.8.12.2 Material Requirements

- Convex mirrors of approved quality not less than 2mm thick. Diameter of mirror should be decided on the basis project requirements and after approval from Engineer in Charge. They should be durable, vandal resistant, and of weather proof material and construction. Acrylic, highly polished stainless steel or polycarbonate convex mirrors should be used.
- Steel Pole, Nuts, Bolts and other ancillary items should be used of approved standard and should be approved by the Engineer in Charge.

16.8.12.3 Construction Requirements

During the installation of traffic mirrors relevant specifications of heading 16.8.7 of these specifications should be fulfilled.

16.8.12.3.1 Road Safety Assessment

A road safety audit should be conducted before a decision is made to install a convex mirror on a public road. Considering the problems inherent in the design and in the use of convex mirrors, the road safety assessment must show that there are safety benefits in installing the mirror rather than installing other traffic management, engineering or safety measures.

The road safety assessment and consequent decision to install the convex mirror must be fully documented.

1. Application

Mirrors can be used to overcome sight restrictions in two distinctly different road environments:

-

- Entering the road network, i.e. from a driveway, and
- Within the road network, i.e. at intersections, junctions, or on single lane roads with opposing traffic flows (e.g. at hairpin bends).\

Where there is a concealed entrance to a property, the following treatments should be considered first: -

- relocation of the driveway or private access
- turning restrictions
- improvements to sight distance such as vegetation trimming
- bank/cutting soil removal
- alteration and/or relocation of property fencing
- shoulder acceleration or deceleration areas.

Convex safety mirrors shall not be installed: -

- on public roads where alternative traffic management measures or engineering measures such as improvements to sight distance and road-realignment are available in the short term.
- to enhance the safety of pedestrian crossing movements. Other solutions should be considered, such as relocation of the crossing point or strategically located pedestrian refuges

Convex mirrors may be used as an interim measure until appropriate traffic management/engineering works are carried out.

2. Legal Issues

Convex safety mirrors are not considered traffic control devices and so do not require approval as a Major Traffic Control Device. However, the road authority may be legally liable for a negligence claim where a person has been injured through reliance on a convex mirror installed on a road under its care. To minimize the exposure to such a claim, the following three step process should be carried out: -

- Use documented road safety audit procedures to assess the road safety benefits relative to the risk of crashes in installing a convex mirror at a particular location,
- Make a decision based on the assessment of the road safety benefits and the risk of crashes arising from the installation, and
- Take all necessary steps to ensure safe and proper installation, operation, and use of the mirror.

All necessary precautions should be taken to securely install a convex mirror at the appropriate location and height to ensure safety of all road users (including pedestrians) and to prevent vandalism.

Under section 63 of the Road Management Act, a convex mirror may only be installed on a public road subject to any conditions stipulated in the written consent from the coordinating road authority.

Convex mirrors must be regularly inspected by the road authority to ensure that the mirror is adequately maintained, in a serviceable condition and is correctly aligned.

16.8.12.3.2 Criteria for Use

severe problem with sight distance and there are no other viable options available. They should only be considered where an intersection or driveway does not meet the requirements for 'Safer Intersection Sight Distance' (SISD) and 'Minimum Gap Sight Distance' (MGSD) as stated in the Austroads Guide to Road Design Part 4A: Unsignalized and Signalized Intersections.

Convex mirrors should only be used in low-volume, low-speed road environments. The traffic being viewed in the mirror should have an 85th percentile speed of 60 km/h or less. The image of a vehicle travelling faster than this would be very small at the required sight distance.

Convex mirrors are typically where the lateral sight distance is poor at locations such as obscured T-junctions, concealed driveways, acute bends of a narrow road, such as hairpin bends in mountain passes, parking areas with acute exit driveways, or approaches to skewed railway level crossings.

Convex Mirrors for concealed entrance should only be considered as a last resort. Where there is a concealed entrance, the following treatment should be considered first: -

- Relocation of the driveway or private access;
- Turning restrictions;
- Improvements to sight distance such as vegetation trimming;
- Bank/cutting soil removal;
- Alteration and/or relocation of property fencing;
- Shoulder acceleration or deceleration area;
- Concealed Entrance signage

16.8.12.3.3 Installation Details

Convex mirrors must be securely mounted to a pole, wall or other high point to deter vandalism and ensure road user safety. Appropriate signs must be included and these are detailed in the following section.

The convex mirror should be fitted with a visor at its top. This will reduce the accumulation of dust on the mirror surface. The fitting of a brightly coloured protective outer band (target board) will assist in improving the conspicuity of the mirror which could be of assistance to road users who are not regular visitors to the area.

The convex mirror should be installed at a location that provides the best view of the road and the oncoming vehicles concerned. It is also necessary to test for a variety of driver eye heights, e.g. car, truck, etc. Mirrors should be positioned such that the driver required to give-way can see the conflicting vehicle in approximately the centre of the mirror. It may be necessary to use two mirrors when one mirror does not give a complete view of the road scene. Consideration should also be given to potential problems resulting from headlight glare at night and the effect of glare from the sun, particularly at dawn and dusk.

16.8.12.3.4 Signage Requirement

The 'Distorted Image' (P1-V141) sign must be installed below the mirror. An advance sign 'Convex Mirror Ahead' (P1-V140) may be required if the location of the convex mirror is not obvious. This sign would be used to warn road users of the presence of the convex mirror as they approach the intersection where it is located.

16.8.12.4 Measurement and Payment

Payment should be included of Purchasing and complete fixing of traffic mirrors on site along with the labor charges.

Item Code	Item Description	Unit
16-07	Fixing and installation of traffic mirrors in all respects on site	No.

16.8.13 Retaining Walls

16.8.13.1 Description

Retaining walls are used to provide lateral resistance for a mass of earth or other material to accommodate a transportation facility. These walls are used in a variety of applications including right-of-way restrictions, protection of existing structures that must remain in place, grade separations, new highway embankment construction, roadway widening, stabilization of slopes, protection of environmentally sensitive areas, staging, and temporary support including excavation or underwater construction support, etc. These specifications provide guidance on formation and construction of retaining walls in all respects.

16.8.13.2 Retaining Wall Types

1. Gravity Walls

Gravity walls are considered externally stabilized walls as these walls use self-weight to resist lateral pressures due to earth and water. Gravity walls are generally subdivided into mass gravity, semi-gravity, modular gravity, mechanically stabilized reinforced earth (MSE), and in-situ reinforced earth wall (soil nailing) categories.

a. Mass Gravity Walls

A mass gravity wall is an externally stabilized, cast-in-place rigid gravity wall, generally trapezoidal in shape. The construction of these walls requires a large quantity of materials so these are rarely used except for low height walls less than 8.0 feet. These walls mainly rely on self-weight to resist external pressures and their construction is staged as bottom up construction, mostly in fill or cut/fill situations.

b. Semi-Gravity Walls

Semi-gravity walls resist external forces by the combined action of self-weight, weight of soil above footing and the flexural resistance of the wall components. A cast-in-place (CIP) concrete cantilever wall is an example and consists of a reinforced concrete stem and a base footing. These walls are non-proprietary. Cantilever walls are best suited for use in areas exhibiting good bearing material. When bearing or settlement is a problem, these walls can be founded on piles or foundation improvement may be necessary. The use of piles significantly increases the cost of these walls. Walls exceeding 28 feet in height are provided with counter-forts or buttress slabs. Construction of these walls is staged as bottom-up construction and mostly constructed in fill situations. Cantilever walls are more suited where MSE walls are not feasible, although these walls are generally costlier than MSE walls.

c. Modular Gravity Walls

Modular walls are also known as externally stabilized gravity walls as these walls resist external forces by utilizing self-weight. Modular walls have prefabricated modules/components which are considered proprietary. The construction is bottom-up construction mostly used in fill situations.

Modular Block Gravity Walls

Modular block concrete facings are used without soil reinforcement to function as an externally stabilized gravity wall. The modular blocks are prefabricated dry cast or wet cast concrete blocks and the blocks are stacked vertically or slightly battered to resist external forces. The concrete blocks are either solid concrete or hollow core concrete blocks. The hollow core concrete blocks are filled with crushed aggregates or sand. Modular block gravity walls are limited to a maximum design height of 8 feet under optimum site geometry and soils conditions, but site conditions generally dictate the need for MSE walls when design heights are greater than 5.5 feet. Walls with a maximum height of less than 4 feet are deemed as "minor retaining walls" and do not require an R number.

Prefabricated Bin, Crib and Gabion Walls

Bin Walls: Concrete and metal bin walls are built of adjoining open or closed faced bins and then filled with soil/rocks. Each metal bin is comprised of individual members bolted together. The concrete bin wall is comprised of prefabricated interlocking concrete modules. These wall systems are proprietary wall systems.

Crib Walls: Crib walls are constructed of interlocking prefabricated units of reinforced or unreinforced concrete or timber elements. Each crib is comprised of longitudinal and transverse members. Each unit is filled with free draining material. These wall systems are proprietary wall systems.

Gabion Walls: Gabion walls are constructed of steel wire baskets filled with selected rock fragments and tied together. Gabions walls are flexible, free draining and easy to construct. These wall systems are proprietary wall systems. Maximum heights are normally less than 21 feet. These walls are desirable where equipment access is limited. The wires used for constructing gabions baskets must be designed with adequate corrosion protection.

d. Rock Walls

Rock walls are also known as 'Rockery Walls'. These types of gravity walls are built by stacking locally available large stones or boulders into a trapezoid shape. These walls are highly flexible and height of these walls is generally limited to approximately 8.0 feet. A layer of gravel and geotextile is commonly used between the stones and the retained soil. These walls can be designed using the FHWA Rockery Design and Construction Guideline.

2. Non-Gravity Walls

Non-gravity walls are classified into cantilever and anchored wall categories. These walls are considered as externally stabilized walls and generally used in cut situations. The walls include sheet pile, soldier pile, tangent and secant pile type with or without anchors.

a. Cantilever Walls

These types of walls derive lateral resistance through embedment of vertical elements into natural ground and the flexure resistance of the structural members. They are used where excavation support is needed in shallow cut situations.

Cantilever Sheet Pile Walls: Cantilever sheet pile walls consist of interlocking steel panels, driven into the ground to form a continuous sheet pile wall. The sheet piles resist the lateral earth pressure utilizing the passive resistance in front of the wall and the flexural resistance of the sheet pile. Most sheet pile walls are less than 15 feet in height.

Soldier Pile Walls: A soldier pile wall derives lateral resistance and moment capacity through embedment of vertical members (soldier piles) into natural ground usually in cut situations. The vertical elements (usually H piles) may be drilled or driven steel or concrete members. The soil behind the wall is retained by lagging. The lagging may be steel, wood, or concrete. For permanent walls, wall facings are usually constructed of either cast-in-place concrete or precast concrete panels (prestressed, if needed) that extend between vertical elements. Soldier pile walls that use precast panels and H piles are also known as post-and-panel walls. Soldier pile walls can also be constructed from the bottom-up. These walls should be considered when minimizing disturbance to the site is critical, such as environmental and/or construction procedures. Soldier pile walls are also suitable for sites where rock is encountered near the surface, since holes for the piles can be drilled/prebored into the rock.

Tangent and Secant Pile Walls: A tangent pile wall consists of a single row of drilled shafts (bored piles) installed in the ground. Each pile touches the adjacent pile tangentially. The concrete piles are reinforced using a single steel beam or a steel reinforcement cage. A secant wall, similar to a tangent pile wall, consists of overlapping adjacent piles. All piles generally contain reinforcement, although alternating reinforced piles may be necessary. Secant and tangent wall systems are used to hold earth and water where water tightness is important, and lowering of the water table is not desirable. To improve wall water tightness, additional details can be used to minimize water seepage.

b. Anchored Walls

Anchored walls are externally stabilized non-gravity cut walls. Anchored walls are essentially the same as cantilever walls except that these walls utilize anchors (tiebacks) to extend the wall heights beyond the design limit of the cantilever walls. These walls require less toe embedment than cantilever walls. These walls derive lateral resistance by embedment of vertical wall elements into firm ground and by anchorages. Most commonly used anchored walls are anchored sheet pile walls and soldier pile walls. Tangent and secant walls can also be anchored with tie backs and used as anchored walls. The anchors can be attached to the walls by tie rods, bars or wire tendons. The anchoring device is generally a dead man, screw-type, or grouted tieback anchor. Anchored walls can be built to significant heights using multiple rows of anchors.

16.8.13.3 Material Requirements

The unit weight and strength properties of retained earth and foundation soil/rock (γ_f) are supplied in the geotechnical report and should be used for design purposes. All other properties should fulfill the requirements of chapter 6 of these specifications:

- Granular Back fill
- Concrete
- Steel Reinforcement

16.8.13.4 Construction Requirements

Concrete retaining shall construct in accordance with the details shown plans and in conformance with the requirements of these specifications and Engineer in charge.

16.8.13.4.1 Mechanically Stabilized Earth Walls**1. Construction****a. Working Drawings and Design**

- Design wall system in accordance with the specified edition of DeIDOT's Bridge Design Manual and the specified edition of the AASHTO LRFD Bridge Design Specifications. Engineer of Record is responsible for external stability. Wall system designer is responsible for all other limit states for the selected wall system.
- Prepare and submit Working Drawings for the MSE Walls. Such drawings must be sealed by a Professional Engineer registered in the State of Delaware and must be approved by the Engineer prior to fabrication. Such approval shall not relieve the Contractor of any responsibility under the Contract for the successful completion of Work. The Working Drawings must include, but not be limited to, the following:
 - Earthwork requirements, including specifications for Material and compaction of backfill.
 - Details of revisions or additions to drainage systems or other facilities required to accommodate the system.
 - Details of barriers connected to the wall.

- Existing ground elevations, stations, and offsets verified by the Contractor for each location involving construction wholly or partially in original ground or at locations specified in the Contract Documents.
- Complete design calculations substantiating that proposed designs satisfy the design parameters in the Contract Documents.
- Complete details of all elements required for the proper construction of the retaining wall system, including complete material specifications.
- Complete list of Materials.
- For modular block walls, include the following: -
 - Length, location, and type of wall.
 - Step-by-step process for constructing the wall.
- Furnish the Engineer a Certificate of Compliance certifying that the furnished Materials comply with the applicable Contract Specifications. Also furnish to the Engineer a copy of all test results performed by the Contractor or his supplier necessary to assure Contract compliance.

b. Excavation and Backfill

- Excavate to the elevations shown in the Contract Documents in accordance with 'Structural Excavation and Backfill'.
- Grade the foundation level for a width equal to or exceeding the length of the reinforcing strips or as required for the retaining wall system.
- Compact the foundation as directed by the Engineer prior to wall construction. Remove and replace any foundation soils found to be unsuitable, as directed by the Engineer.
- Simultaneously construct the surrounding earth embankment with the backfill and compact in lifts at the same elevation, meeting density requirements as stipulated in the Contract Documents.

c. Piles

- Drive piles prior to constructing the wall system unless noted otherwise in the Contract Documents.

d. Leveling Pad

- At each panel foundation level, provide an unreinforced concrete leveling pad as shown in the Contract Documents. Cure the leveling pad a minimum of 12 hours before placement of wall panels. The concrete finish must be smooth and flat and not vary from the design elevation as shown in the Contract Documents.
- For modular block walls, construct the foundation element, either a leveling pad or footer, in accordance with the manufacturer's instructions.

e. Wall Erection

- Place precast concrete panels, constructed in accordance with Section 1048, vertically with the aid of a light crane. Handle panels by means of a lifting device set into the upper edge of the panels, and place in successive horizontal lifts in the sequence shown on the Working Drawings as backfill placement proceeds. As backfill Material is placed behind the panels, maintain the panels in vertical position by means of

temporary wooden wedges placed in the joint at the junction of the two adjacent panels on the external side of the wall. External bracing is required for the initial lift.

- Meet the following tolerances: -
 - Vertical plumbness tolerances and horizontal alignment tolerances cannot exceed 3/4 inch when measured along a 10-foot straight edge.
 - The maximum allowable offset between precast components shall be 3/4 inch.
 - The overall vertical plumbness tolerance of the wall from top to bottom cannot exceed 1/2 inch per 10 foot of wall height.
 - Horizontal and vertical joints between precast components shall not be less than 1/2 inch or more than 1-1/4 inch.
- Place geotextile fabric and adhesive on the fill face of the panels over each horizontal and vertical joint. Ensure that the fabric extends a minimum of 9 inches onto each panel and is securely adhered to the panels such that no fill can seep through the joint.
- Install reinforcing mesh/strips after backfill compaction is complete. Place reinforcing mesh/strips normal to the face of the wall, unless otherwise shown in the Contract Documents or as directed by the Engineer.
- Grout recesses at lifting devices in tops of topmost panels flush with an approved grout as directed by the Engineer except where there is a poured concrete coping or parapet.
- For modular block walls, construct the wall in accordance with the manufacturer's instructions.

f. Backfill Placement

- Place backfill to closely follow erection of each course of panels. Place backfill in such a manner as to avoid any damage or disturbance to the wall Materials or misalignment of the facing panels. Place stone for at least the first 3 feet normal to the back face of the panel for the full height of the wall. Remove any wall Materials that become damaged or disturbed during backfill placement and correct or replace as directed by the Engineer at no cost to the Department. Correct any misalignment or distortion of the wall facing panels due to placement of backfill outside the limits of this specification as directed by Engineer.
- Compact backfill to 95 percent of the maximum density as determined by AASHTO T 99 Method C or D (with oversize correction, as outlined in Note 7, AASHTO T 99).
- Ensure that the moisture content of the backfill Material prior to and during compaction is uniformly distributed throughout each layer. Place backfill Material with a placement moisture content between optimum moisture content and two percentage points below optimum moisture content. Remove backfill Material with a placement moisture content outside this range and rework until the moisture content is uniformly acceptable throughout the entire lift. Determine the optimum moisture content in accordance with AASHTO T 99 Method C or D (with oversize correction, as outlined in Note 7, AASHTO T 99).
- The maximum lift thickness after compaction cannot exceed 8 inches. Decrease this lift thickness, if necessary, to obtain the specified density.
- Achieve compaction within 3 feet of the back face of the wall facing by at least 3 passes of a lightweight mechanical tamper, roller, or vibratory system.
- At the end of each day's operation, slope the last level of backfill away from the wall facing to rapidly direct runoff of rainwater away from the wall face. In addition, do not allow surface runoff from adjacent areas to enter the wall construction site.

- For modular block walls, place and compact the backfill Material in accordance with the manufacturer's instructions.

16.8.14 Boundary Pillars

16.8.14.1 General

The boundary pillars shall be of either precast RCC or hard stone of sound and durable quality. These shall be in blocks of size 6 x 6 inches at top and 9 x 9 at bottom and having length of 30 inches unless directed otherwise by the Engineer-in-Charge. A tolerance of 12.5 mm shall be permitted in the specified size. In the case of boundary stones of hard stone, the upper 30 cm shall be chisel dressed on all the four sides and on the top.

16.8.14.2 Precast Concrete Pillars

The precast concrete boundary pillars shall be cast in cement concrete 1:2:4 (1 cement: 2 coarse sand: 4 graded stone aggregate 20mm nominal size), where specified reinforced with 10mm diameter tor steel bars or as directed. The precast concrete pillars shall be finished smooth with 1:3 cement mortars.

The lower half portion of the boundary pillars or as shown and drawings shall be encased on all sides by at least 15 cm of 1:4:8 foundation concrete (1 cement: 4 fine sand: 8 graded stone aggregates of 40 mm nominal size). The work shall be carried out according to the applicable provisions of Plain & Reinforced Concrete.

16.8.14.3 Hard Stone Boundary Pillars

The hard-stone boundary pillars shall be as stated: -

The kilometers stones shall be either precast concrete or of hard durable stone in shape and sizes as specified.

The precast stones shall be cast in-situ 1:2:4 concrete complying with the provisions of Plain & Reinforced Concrete. To obtain smooth finish, 1:3 cement sand mortar shall be applied.

The excavation for foundation as specified for installation shall comply with the provision of Earthwork. The pillar shall be fixed in 1:4:8 concrete of the specified size and backfilled. The letters as specified shall be engraved or painted.

16.8.14.4 Engraving / Letters

The boundary pillars shall be engraved/written letters for each pillar as specified.

16.8.14.5 Measurement

Boundary Pillar shall be enumerated and paid according to the Item code 16-17-c of this MRS.

16.8.15 Kilometer Stones

16.8.15.1 General

The kilometers stones shall be either precast concrete or of hard durable stone in shape and sizes as specified.

16.8.15.2 Precast Concrete Stones

The precast stones shall be cast in-situ 1:2:4 concrete complying with the provisions of Plain & Reinforced Concrete. Size of Kilometer stone should be 1.5' X 3.5' with 2"x3/4" thick metallic strips all around. Steel bars of size 3/8" MS Grade 40 bars 7 No. horizontal and 3 No vertical. To obtain smooth finish, 1:3 cement sand mortar shall be applied.

Foundation depth for kilometer stone should be 1.5 feet or as per the directions of Engineer in Charge. The pillar shall be fixed in 1:4:8 concrete of the specified size and backfilled. The letters as specified shall be engraved or painted.

16.8.15.3 Hard Stone Kilometer

The hard-stone kilometer shall comply the provisions for boundary stone under Clause 16.8.15.1. The letters shall be engraved or painted as specified.

16.8.15.4 Measurement

Kilometer stones shall be enumerated and shall paid according to the item code 16-17-a, b of this MRS.

16.8.16 Road Survey Accessories**16.8.16.1 Bamboo Jhandies and Flag**

Bamboo should be good quality and free of any knot and should be approved size. Bamboo dia should not be less than 38 mm and bamboo should be painted black and white as per the directions of Engineer incharge.

Flag should be made of rough cotton cloth and stich the sides of flag. Flag should be approved size and color as per directions of Engineer in charge.

16.8.16.2 Wooden Pegs

Wooden pegs for surveying should be made from any hard wood (kekar or any other approved quality) of approved size and quality. Peg should be strong enough to penetrate through the hard strata. ½ length of pegs should be marked with approved color to prevent the pedestrian traffic.

16.9 Repairing of Existing Pavement

16.9.1 Asphalt Pavement Crack Routing and Sealing

16.9.1.1 General

The purpose of crack sealing is to prolong the life of existing pavements by preventing moisture from penetrating the roadway structure, and by preventing the spalling of material from the edges of the cracks.

The Work shall consist of routing, cleaning and drying cracks and sealing them with crack sealant between the limits shown on the Drawings or as directed by the Consultant.

16.9.1.2 Materials

1. Crack Sealant

The Contractor shall choose and supply hot pour rubberized crack sealant material from the proven products of the Alberta Transportation Products List. Products not listed as proven require the Department's approval prior to use.

The Contractor shall provide the Consultant with the following information five days prior to commencing the Work: -

- Name and mailing address of crack sealant Supplier and Manufacturer
- Name of crack sealant product to be supplied
- Written confirmation from the Manufacturer that the crack sealant to be supplied meets all specified requirements along with test results that demonstrate that the product meets all specified requirements.

The Contractor shall verify that all crack sealant delivered and used in the Work is the type and grade ordered.

The Contractor shall supply the Consultant with the Manufacturer's quality control test results (indicating at the minimum cone penetration and flow) for each batch of crack sealant. These test results shall be supplied at the time of delivery of each batch of crack sealant to the Work.

All crack sealant supplied shall be subject to inspection, sampling and testing by the Department and the Contractor shall cooperate in the inspection and sampling process. When directed by the Consultant, the Contractor shall obtain representative samples of the crack sealant delivered to the Work.

2. Blotting Agents

When necessary, the Contractor shall supply one of the following blotting agents: -

- screened sand with a maximum top size of 2 mm
- cement
- fly ash

The use of other products shall be subject to the approval of the Consultant.

16.9.1.3 Equipment

The Contractor shall supply all equipment necessary for completion of the Work including but not limited to the melting kettle, air compressor unit, hot compressed air lance, routing and crack sealing equipment and all related equipment such as fork lifts, hoists, and transport vehicles.

The melting kettle shall consist of a double jacketed oil bath kettle with thermometric controls which automatically control the product temperatures and with continuous agitation equipment to prevent localized variations in temperature. The kettle shall be equipped with two calibrated thermometers to monitor the temperature of the crack sealant and the temperature of the heat transfer oil.

The mechanical router shall be capable of producing the specified rout cross-section.

The compressed air unit shall be equipped with water and oil traps and must produce sufficient air volume and pressure to remove all debris from the cracks. It shall be capable of delivering a continuous stream of clean, dry air at 600 kPa and 4.5 m³ /min.

Application equipment shall be capable of regulating the application of crack sealant directly to the road and shall be equipped with a thermometer to monitor the temperature of the material as it is applied.

The hot compressed air lance shall be capable of providing a continuous hot, high pressure air stream (1000°C at a rate of 1000 m/sec) with no flame at the exit nozzle.

16.9.1.4 Crack Routing and Sealing

All work shall be performed during daylight hours only. No work shall be performed if the visibility is less than 700 m. No work shall be performed during rain or snow or when the pavement surface is wet. The maximum work area shall be 3 km in length. The crack sealant shall not be applied when the pavement temperature is below 10° Celsius. Unless otherwise directed by the Consultant, all transverse cracks between 2 mm and 25 mm in width and longitudinal cracks between 2 mm and 12 mm in width which are within the driving lanes of the pavement surface shall be routed and sealed. Routing and sealing shall extend 0.5 m into the pavement shoulders. Cracks shall be routed to the applicable cross-section shown on Drawing CB6-10.6M1, keeping the crack in the centre of the rout cross-section. Prior to the application of crack sealant, the road surface adjacent to the cracks shall be cleaned and all loose material and moisture shall be removed from the routed cracks. All debris resulting from the cleaning and routing operation shall be removed from the road surface. The routed cracks shall be treated with the hot compressed air lance until the pavement in the routed crack is dry and slightly darkened. There shall be a maximum time period of 2 minutes between cleaning and drying the routed cracks and the application of the crack sealant. Crack sealant shall be heated and applied within the applicable specified temperature ranges and in accordance with the Manufacturer's recommendations. The heat transfer oil in the melting kettle shall not be heated in excess of 50° C above the safe heating temperature. Routed cracks shall be filled with crack sealant such that upon cooling, the filled crack is as shown on the Drawings. Excessive crack sealant shall be removed from the pavement surface immediately following application. Traffic shall be kept off sealed cracks until the crack sealant has cured. At locations such as intersections where this is not practical, the Contractor shall prevent tracking by applying a blotting agent to the crack sealant. When a blotting agent is used, it shall not be applied until the sealant has cooled sufficiently to prevent inclusion of the blotting agent into the sealant. Fuel, asphalt and any other spills shall be cleaned up to the satisfaction of the Consultant at the Contractor's expense.

16.9.1.5 Measurement and Payment

Measurement will be made in meters of the length of cracks on which crack routing and sealing has been performed.

Payment will be made at the unit price bid per meter for "Crack Routing and Sealing" subject to the unit price adjustments specified in this section. This payment will be full compensation for routing, cleaning and drying the cracks, cleaning the pavement surface, supplying and applying the crack sealant, quality control and traffic accommodation.

When payment adjustments equal 100% or greater, the Contractor may be required to remedy the Lot to meet specified tolerances. This shall include removing all sealant, preparing the routs and resealing. Payment for the Lot shall be based on the new work.

16.9.2 Asphalt Pavement Crack Sealing

16.9.2.1 General

The purpose of crack sealing is to prolong the life of existing pavements by preventing moisture from penetrating the roadway structure, and by preventing the spalling of material from the edges of the cracks.

The Work shall consist of sealing cracks with crack sealant between the limits shown on the Drawings or as directed by the Consultant.

16.9.2.2 Materials

The Contractor shall supply all materials necessary for the Work including the crack sealant. The Contractor shall provide the Consultant with the following information 5 days prior to commencing the Work: -

- Name and mailing address of crack sealant Supplier and Manufacturer
- Name of crack sealant product to be supplied
- Written confirmation from the Manufacturer that the crack sealant to be supplied meets all specified requirements along with test results that demonstrate that the product meets all specified requirements.

The Contractor shall verify that all crack sealant delivered and used in the Work is the type and grade ordered.

The Contractor shall supply the Consultant with the Manufacturer's quality control test results for each batch of crack sealant. These test results shall be supplied at the time of delivery of each batch of crack sealant to the Work.

Product	Quality Control Testing Requirements	
Cold Pour	a) Uniformity	TLT-226
	b) Viscosity	TLT-227
	c) Solids Content (residue by evaporation, procedure A)	ASTM D244
	d) Rate of Curing (24 hour)	TLT-230
Hot Pour	a) Softening Point	ASTM D36
	b) Penetration @ 25°C	ASTM D5
	c) Viscosity	ASTM D2170

Table 98, Quality Control Testing Requirements

When necessary, the Contractor shall supply one of the following blotting agents: -

- screened sand with a maximum topsize of 2 mm
- cement
- flyash

The use of other products shall be subject to the approval of the Department.

16.9.2.3 Equipment

The Contractor shall supply all equipment necessary for completion of the Work including but not limited to the melting kettle (Hot Pour only), crack sealing equipment and all related equipment such as fork lifts, hoists, and transport vehicles.

The melting kettle shall consist of a double jacketed oil bath kettle with continuous agitation equipment to prevent localized heating. The kettle must be equipped with two thermometers to show the temperature of the crack sealant and the temperature of the heat transfer oil.

Application equipment must be capable of regulating the application of crack sealant directly to the road.

16.9.2.4 Crack Sealing

- All work shall be performed during daylight hours only. No work shall be performed if the visibility is less than 700 m. No Work shall be performed during rain or snow or when the pavement surface or cracks are wet. The maximum work area shall be 3 km in length.
- Crack sealant shall not be applied when the atmospheric temperature at the construction site is below 0° Celsius.
- All cracks within the entire width of the pavement surface, which are 5 mm and greater in width shall be sealed.
- Prior to the application of crack sealant, the Contractor shall ensure that the road surface adjacent to the cracks is clean.
- Hot pour crack sealant shall be heated to the temperature specified by the Manufacturer. Overheating will not be permitted.
- Crack sealant shall be applied within the Manufacturer's specified temperature range.
- Crack sealant shall be applied so that the crack is flush filled immediately following application and a thin over band of sealant extends approximately 25 mm beyond the edges of the crack.
- Excess crack sealant shall be removed from the pavement surface immediately following application. Removal shall involve the use of a squeegee, starting from the centerline and proceeding to the shoulder.
- Traffic shall be kept off sealed cracks until the crack sealant will not track under the action of traffic. At locations such as intersections where this is not practical, the Contractor shall prevent tracking by applying a blotting agent to the crack sealant.
- Fuel, asphalt and any other spills shall be cleaned up to the satisfaction of the Consultant at the Contractor's expense. Work that does not meet the foregoing requirements shall be repaired or reconstructed to the satisfaction of the Consultant and at the Contractor's expense

16.9.2.5 Measurement and Payment

Measurement will be made of the length of roadway, in kilometers, on which crack sealing has been performed.

A roadway will include all travel lanes, shoulders, acceleration and deceleration lanes, truck

turnouts and intersections. A divided or twinned highway will be considered two separate roadways.

Payment will be made at the unit price bid per kilometer for "Crack Sealing" subject to the unit price adjustments specified herein. This payment will be full compensation for cleaning the road surface adjacent to the cracks, supplying and applying the crack sealant, quality control, traffic accommodation and signing.

16.9.3 Crack Repair - Spray Patch

16.9.3.1 General

The Work consists of repairing transverse and longitudinal cracks by cleaning the defect of all rock, dirt, sand or other objectionable material, applying asphalt binder as a tack material, filling with a mixture of asphalt binder and crushed aggregate and compacting the mix. The Contractor shall produce crushed aggregate meeting the following gradation specifications.

Metric Sieve Size m	% Passing
12 500	100
10 000	90 - 100
5 000	20 - 100
2 500	5 - 30
1 250	0 - 10

Table 99, Material Requirements

The Contractor shall supply an emulsified asphalt binder appropriate for the aggregate materials used.

16.9.3.2 Equipment

The Contractor shall supply all equipment necessary to complete the Work. The equipment required includes but is not limited to the following: -

- A compressor for high pressure air with a minimum rated capacity of 5.2 cubic metres per minute (185 CFM) capable of blowing the crack clean of all dirt, sand, rock, or other objectionable material.
- A proprietary or prototype machine capable of spraying the asphalt into the crack, and then combining crushed aggregate and asphalt and spraying the mixture into the crack.
- Appropriate compaction equipment.

16.9.3.3 Procedure

- The Consultant will determine which cracks are to be repaired. Generally, cracks less than 5 mm width will not require repair. Potholes or other surface defects that are contiguous with cracks are considered to be 'crack related' and are to be repaired by spray patching.
- Work shall not be performed when the atmospheric temperature at the work site is below 5°C.
- All objectionable material shall be removed from the open crack and surrounding area by blowing with high pressure air streams or other means acceptable to the Consultant.
- Cleaned cracks shall be sprayed with the emulsified asphalt, and then sprayed with the combined asphalt and crushed aggregate mixture.

- Some over-spraying of the crack will be required to ensure a smooth transition between the repaired crack and the adjacent undisturbed pavement surface.
- The repaired area shall be compacted to ensure adequate embedment of the asphalt aggregate mixture into and over the crack.
- All loose aggregate and debris shall be swept or removed from the pavement surface and disposed of to the satisfaction of the Consultant. Generally, the debris may be swept or blown evenly over the side slopes however, when indicated in the Special Provisions, the Contractor shall pickup, haul and dispose of it at a location acceptable to the Consultant.

16.9.3.4 Schedule Limitations

The Contractor shall schedule his operations to ensure that crack repair is completed a minimum of two weeks prior to any required pavement overlay.

16.9.3.5 Measurement and Payment

Measurement will be in meters based on the length of cracks treated.

Payment will be made at the unit price bid per meter for "Crack Repair - Spray Patch". This payment will be full compensation for cleaning the cracks; disposing of the debris; tacking; supplying the crushed aggregate and asphalt binder; producing, hauling, placing and compacting the mix; traffic accommodation and signing; and all labour, materials, equipment, tools and incidentals necessary to complete the Work.

16.9.4 Crack Repair - Mill and Fill

16.9.4.1 General

The Work consists of repairing cracks by milling a rectangular trench centered over the crack, filling the trench with asphalt concrete pavement mix, then compacting the mix.

16.9.4.2 Materials

1. General

All materials necessary for the described herein shall be supplied by the Contractor.

2. Aggregate

Aggregate shall conform to Chapter-6 of Book-1 (Specification for Engineering Material).

3. Asphalt

The Contractor shall supply asphalt in accordance with Specification.

4. Asphalt Mix Design

The asphalt mix design shall be prepared and submitted to the Consultant in accordance with the Asphalt Mix Design and Job Formula Mix Formulas. Unless otherwise specified, the mix type shall be at the Contractor's discretion.

16.9.4.3 Equipment

The Contractor shall supply all equipment necessary for completion of the Work including, but not limited to, the following: -

- A dry process cold milling machine capable of milling a rectangular trench meeting the specified dimensions. Milling machines using water to cool the milling head will not be permitted.
- Sweeping and blowing equipment capable of removing all loosened material from the milled trench and off the roadway surface.
- Hand spraying equipment for applying the tack coat.
- All equipment necessary for supplying, placing and compacting the asphalt concrete mix.

16.9.4.4 Construction

1. General

- No work shall be carried out when the pavement surface is wet.
- The Consultant will designate which cracks are to be repaired.
- The maximum work area shall be 3 km in length. For transverse crack repair, work shall be confined to one lane at a time. The Contractor shall include these requirements in his Traffic Accommodation Strategy.

2. Crack Repair

Unless otherwise specified, the Contractor shall mill a rectangular trench centered over the crack. Trench dimensions shall be as follows: -

- For crack repairs designated as "Mill and Fill", the trench shall be 400 mm wide by 150 mm deep or the depth of the existing asphalt material, whichever is less.
- For crack repairs designated as "Shallow Mill and Fill", the trench shall be 400 mm wide by 50 mm deep.

For transverse cracks, the trench shall extend across the width of the lane and 0.3 m on to the shoulder unless otherwise specified.

All loosened material shall be removed from the trench, and the milled surfaces shall be left clean and dry. The milled material shall be swept to the shoulder of the road and disposed of on the side slope. When identified in the Special Provisions, milled material shall be removed from the roadway and disposed of by the Contractor at a disposal site acceptable to the Consultant.

The Contractor shall apply tack coat to all exposed pavement edges by means of hand spraying.

The asphalt concrete pavement mix shall be placed and compacted to the top of the milled trench in lifts not greater than 75 mm thick to a minimum of 96% Marshall density, or as otherwise specified. Asphalt cores taken for density testing shall be taken from the center of the notch.

The Contractor shall backfill all milled trenches the same day.

Where the drawings show that subsequent lifts of asphalt concrete pavement are to be placed, the Contractor shall schedule his operations to ensure that a minimum of one lift is placed prior to seasonal shutdown.

16.9.4.5 Measurement and Payment

Measurement will be in meters based on the length of cracks acceptably repaired.

Payment will be made at the unit prices bid for "Crack Repair - Mill and Fill" or "Crack Repair – Shallow Mill and Fill, as applicable, and will be full compensation for cold milling; disposal of milled material; supplying and applying tack coat; supplying, placing and compacting the asphalt mix; and all labour, equipment, tools and incidentals necessary to complete the Work to the satisfaction of the Consultant.

16.9.5 Surface Dressing on Old Surface with Hot Bitumen

16.9.5.1 General

This treatment consists of cleaning old painted surface and applying a coat of hot bitumen on the prepared base, blinding with stone chippings and consolidation with road roller.

16.9.5.2 Materials

The aggregates & asphalt materials unless otherwise specified shall conform to the specification.

16.9.5.3 Preparation

Repairs: Pot holes or patches and ruts in the surface course which is to be surface treated, shall be repaired by removal of all loose and defective material by cutting in rectangular patches and replacement with suitable material.

For the purpose of repairs the area of pot holes shall be taken up to 0.75 sqm and depth up to 5 cm. All pot holes, patches and ruts up to 2 cm deep shall be repaired and brought to level with premix and properly consolidated while those of depths greater than 2.5 cm shall be repaired with similar specifications as adopted originally. Prior to the application of the surface dressing all dust, dirt, caked mud, animal dung, loose and foreign material etc. shall be removed 30 cm on either side, beyond the full width to be treated, by means of mechanical sweepers and blowers or with wire brushes, small picks, brooms etc. The material so removed shall be disposed off as directed by the Engineer-in Charge. For a water bound macadam surface, the interstices between the road metal shall be exposed up to a depth of about 10mm by means of wire brushes. The surface shall then be brushed with soft brooms to remove all loose aggregate. Finally, the traces of fine dust which get accumulated while brushing shall be thoroughly removed from the surface by blowing with gunny bags. The prepared surface shall be closed to traffic and maintained fully clean till the binder is applied.

16.9.5.4 Construction Requirements

The construction for dressing shall be carried out complying with the provision of clause 16.4.3.

16.9.5.5 Measurement

Hot Bitumen Coat for both items shall be measured as finished work over the area specified to be covered, in square feet at the bitumen content specified in the item.

Table of Contents

17	LINING OF CANALS	2
17.1	Scope	2
17.2	Construction Materials	2
17.2.1	Clay Bricks and Tiles	2
17.2.2	Cement	2
17.2.3	Sand	2
17.2.4	Water	2
17.2.5	Cement Mortar	2
17.2.6	Stones	2
17.2.7	Concrete	3
17.2.8	Reinforcement	3
17.2.9	Formwork	3
17.2.10	Asphalt	3
17.3	Construction Requirements	3
17.3.1	General	3
17.3.2	Asphalt/Bitumen lining	5
17.3.3	Bricks/Tiles Canal lining	5
17.3.4	Concrete canal Lining	8
17.3.5	Precast Concrete lining	11
17.4	Measurement and Payment	12
17.4.1	Measurement	12
17.4.2	Payment	12

LINING OF CANALS

17.1 Scope

This chapter comprises of specifications for the preparation of the subgrade, its dressing, canal lining and all incidental operations necessary to construct the lining in canals in accordance with the drawings and these Specifications and subject to approval of the Engineer.

17.2 Construction Materials

17.2.1 Clay Bricks and Tiles

Clay Bricks and Tiles shall conform to the requirements set forth in Chapter 4 of Book I and relevant sections of Chapter 7 of Book II.

17.2.2 Cement

Cement shall conform to the requirements set forth in Chapter 3 of Book I and relevant sections of Chapter 6 of Book II.

17.2.3 Sand

Sand shall conform to the requirements set forth in relevant sections of Chapter 6 of Book I and Book II.

17.2.4 Water

Water shall conform to the requirements set forth in Chapter 2 of Book I and relevant sections of Chapter 6 of Book II..

17.2.5 Cement Mortar

Cement Mortar shall conform to the requirements set forth in relevant sections of Chapter 7 of Book II.

17.2.6 Stones

Stones shall conform to the requirements set forth in Chapter 7 of Book I and relevant sections of Chapter 8 of Book II.

17.2.7 Concrete

The Materials for Concrete shall fulfil the requirements set forth in relevant sections of Chapter 6 of Book II.

17.2.8 Reinforcement

The Materials for Reinforcement shall fulfil the requirements set forth in relevant sections of Chapter 6 of Book II.

17.2.9 Formwork

The Formwork shall fulfil the requirements set forth in relevant sections of Chapter 6 of Book II.

17.2.10 Asphalt

The Materials for Asphalt shall fulfil the requirements set forth in Chapter 11 & 12 of Book I and relevant sections of Book III.

17.3 Construction Requirements**17.3.1 General***17.3.1.1 Preparation of Sub-Grade*

Prior to Canal lining, the contractor shall prepare the subgrade including dressing of bed and side slopes filled or excavated sections of the canal and any other backfill over which canal lining is to be placed. Before proceeding with canal lining, the contractor shall ensure and prove to the satisfaction of the Engineer by means of compaction tests that the subgrade of the whole canal prism (slopes and bed) is in a state of compaction equal to 95% Standard Proctor or 70% relative density depending upon the type of material, to a minimum depth of one (1) foot below the final grade, measured perpendicular to the surfaces of the canal prism. No separate payment shall be made for compaction tests and their cost shall be deemed to have been included in the unit rates quoted for the other relevant items given in the BOQ. The Contractor shall re-work the areas which fail to meet the compaction requirements as described above and shall perform compaction by employing appropriate equipment and methods in order to ensure that the reworked portions meet the compaction requirements described above.

17.3.1.2 Refilling of Over-excavated Areas

If at any point material has been excavated beyond the neat lines required to receive the canal lining, the excess excavation shall be refilled with compacted fill material and according to relevant sections of Chapter 3 (Earthwork) of Book II. If at any point the foundation material is disturbed or loosened during the excavation process or

otherwise, it shall be moistened if required and thoroughly compacted by tamping, rolling or other approved methods in accordance with Chapter 3 (Earthwork) of Book II to form firm foundations to place the canal lining.

17.3.1.3 *Finishing to Lines and Grades*

In addition to the above, the work under subgrade preparation shall include but not be limited to cutting, filling, compacting, reworking, dressing and finishing the canal prism to true and even surfaces to the lines and grades shown on the Drawings in accordance with these Specifications and as directed by the Engineer.

17.3.1.4 *Crushed stone & sand filter*

In case of Concrete lining, 6" inch thick compacted filter, crush stone and sand material with maximum size $\frac{3}{4}$ " inch not more than 35% passing sieve No. 8 & not more than 5% finer than sieve No. 30 meeting the requirement of ASTM C - 33 under the canal lining will be placed, as per drawings and approved by the Engineer.

17.3.1.5 *Trial Section*

Before starting full scale canal lining operations, the Contractor shall carry out a trial section of the complete prism of the canal for a length of not less than 50 feet. This trial section should be carried out in the same area on which trial section for earthwork has already been accepted and approved by the Engineer. The Contractor shall submit his proposals for this trial section to the Engineer for approval at least 14 days before he proposes to start the trial.

The trial section shall demonstrate the sequencing of lining operations, the effectiveness and the quality control of the Contractor's methods including, but not limited to the following matters:

- Preparation of sub-grade and dressing
- Concrete batching arrangements in case of concrete lining,
- Arrangement for construction of canal lining, forms etc.
- Transportation of material, placing & laying of canal lining in all respects as per drawings and upto the satisfaction of Engineer in-charge
- Placement of joints and associated fillers, sealants, curing etc.

The trial section will be incorporated into the Works provided it complies in all respects with these Specifications. Should it not so comply, the Engineer may either instruct remedial measures, or complete removal of the trial section, reinstatement of the foundations, and a repeat trial, all at the Contractor's expense.

17.3.2 Asphalt/Bitumen lining

17.3.2.1 Formation of Asphaltic membrane

- i) The thickness of Asphalt/bitumen membrane shall be as specified in the drawings.
- ii) The special asphalt used for the membrane is prepared by the catalytic blowing of asphaltic materials. It has a very low temperature susceptibility, a high degree of toughness, a resistance to tearing or breaking, and a long life. After the asphalt has been heated to approximately 400 °F, it is applied to the sub-grade under about 50 pounds pressure through spray nozzles, using either hand sprays or multiple spray bars mounted on the distributor.
- iii) Holes or rough areas in the sub-grade can be adequately covered by the hand spray, though this method is somewhat slower. On the other hand, the distributor method is faster, and, therefore, more economical but can be applied satisfactorily only to reasonably smooth sub-grades.
- iv) The hot-applied asphalt cools quickly and is soon ready for the application of the cover material. In fact, a few minutes after the application, the surface may be walked over by the construction personnel in covering operations. Since the purpose of the cover material is to hold the membrane in its place, and to protect it from the sunlight, water, wave wash, or livestock damage the kind and depth of cover material depend on factors like wave-action, water turbulence and velocity. Where water velocities are below one foot and a half per second, the soil removed from the canal in over-excavation may be used provided it is of reasonable stability.
- v) If soil from canal excavation is not suitable, material with greater cohesiveness (clay contents) and stability may be borrowed.
- vi) In canals with very high water velocities gravel blankets (usually of pit-run material) may be placed over the soil cover to depths between 3 and 6 inches.
- vii) Riprap is often used for areas below check structures or where turbulence is severe.

17.3.3 Bricks/Tiles Canal lining

The work to be done under brick or tile lining consist of constructing brick lining or tile lining according to the locations, dimensions and details shown on drawings or as directed by Engineer-in-charge.

17.3.3.1 Formation, Dressing & Preparation of Sub-Grade for brick lining

- i) The Contractor shall prepare the surfaces of the sub-grade in manner that will provide a smooth and firm foundation for the brick/tile lining. The bottom and side slopes, including the surfaces of compacted embankments, shall be finished accurately to the lines, grades and dimensions shown on the drawings or established by the Engineer-in-Charge.
- ii) All excavation of the sub-grade beyond the lines of the underside of the brick lining shall be filled with suitable material, moistened if required, and thoroughly compacted to the prescribed lines and grades in accordance with the requirements of set forth in relevant sections of Chapter 3 (Earthwork) of Book II
- viii) Over-excavated or low portion shall be filled with mortar at the expense of the Contractor.
- ix) After compaction the entire area to be brick lined shall be thoroughly sprinkled with water till the finished sub-grade has been penetrated to a depth of 6 inches. The water shall not be applied at the rate which will cause the sub-grade to be muddy or soft. The finished sub-grade shall be duly approved by the Engineer-In-charge before any brick-lining is laid.

17.3.3.2 Profile Wall

- i) Unless otherwise specified or directed in writing by the Engineer-In-charge, profile walls shall be constructed 15 feet centre to centre at right angle to the centre line of the channel on the side slopes and at 30 feet centres on the bed.
- ii) A profile wall shall also be constructed parallel to the centre line at each toe of the canal side slopes. The final excavation, trimming and compacting of the section may be performed before or after the completion of the walls.
- iii) The profile wall shall be laid by means of a theodolite. The excavation of trench in bed and on slopes for construction of profile including disposal of excavated material shall be made in accordance with applicable provisions of Chapter 3 (Earthwork) of Book II.
- iv) A cement sand mortar as specified shall be laid as plaster over finally finished surface in accordance with applicable provisions of Chapter 7 (Brick Masonry) of Book II.
- v) The wall shall be constructed in accordance with the relevant Provisions of the Chapter 7 (Brick Masonry) of Book II.

17.3.3.3 Placing of Brick lining

Unless otherwise specified, the placing of lining shall follow the sequence as given below:-

- i) A layer of 1:10 cement sand hand mixed mortar having an average thickness of $\frac{1}{2}$ inch shall be plastered over the finally finished sub-grade for making up inequalities in the section.
- ii) Immediately over it a $1\frac{1}{2}$ inches thick layer of 1:6 cement sand machine mixed mortar shall be laid. (The mortar used shall have a slump of $\frac{1}{2}$ inch to $\frac{3}{4}$ inch) To ensure that the correct thickness of $1\frac{1}{2}$ inches is laid over the whole surface, precast cubes 1:6 cement sand mortar having each side of $1\frac{1}{2}$ inches shall be placed on 1:10 plaster at 4 ft centre to centre along the centre line and at right angle to the channel and at 4 ft. intervals. The cubes shall be left embedded in the mortar with their tops flush with the surface.
- iii) The 1:6 mortar layer shall be lightly rammed with wooden rammer and then trowelled to level out irregularities in the surface. The surface shall be rammed again with wooden rammer having $\frac{1}{2}$ inch long spikes with round ends to make indentations.
- iv) A $\frac{3}{8}$ inch thick layer of 1:3 cement sand machine mixed mortar shall be placed over the 1:6 cement sand base. (The mortar used shall have a slump of 2 inch). To ensure an even thickness, the 1:3 mortar shall be laid in strips 4 feet wide with the help of thin laths $1\frac{1}{2}$ " x $\frac{3}{8}$ " and about 18 feet long laid on the 1:6 cement sand base. The 1:3 mortar shall be spread with a trowel and leveled with a straight edge flush with the top of the lath. A day after the mortar is laid, it shall be lightly scraped with the wire brushes.
- v) The next and final layer shall consist of the brick/tiles. The courses shall be marked on the profile walls and the string shall be stretched to keep them straight. Brick tiles to be laid on slopes shall be laid from bottom to the top of side slopes. The laying of the brick/tiles shall commence from the profile wall at the tangent point. The bricks/tiles shall be laid in the 1:3 cement sand machine mixed mortar. The thickness of the mortar bedding under the bricks/tiles shall be $\frac{1}{8}$ of an inch and the vertical joints between the bricks/tiles shall be $\frac{1}{4}$ of an inch thick. All the joints shall be properly filled and to achieve this, the mason shall apply mortar to the sides of the bricks/tiles already laid, lay the next brick/tiles 1 inch to 2 inch away and then press it towards the first brick/tile squeezing out the mortar which would indicate that that joint has been filled. Before the bricks/tiles are laid they shall be soaked in water for at least 24 hours in soaking tanks. The mason shall have with him kerosene oil tin containing water, and the bricks/tiles from soaking tanks shall be placed in these tins. The mason shall use bricks/tiles only from these tins for his immediate requirements. Strict supervision shall be exercised to see that no un-burnt bricks/tiles are placed in the soaking tank and used.
- vi) The joints of the work done on the previous day shall be tested with a broad chisel pointed $\frac{5}{8}$ inch diameter iron bar. The hollow joints shall be marked with

coal tar raked out and filled with the 1:3 cement sand mortar immediately. The brickwork shall be finally brushed and cleaned.

17.3.4 Concrete canal Lining

17.3.4.1 General

In General all the construction requirements for concrete work shall conform to the specifications set forth in Chapter 6 (Concrete) of Book II.

Concrete canal lining shall be constructed in the canal prism as shown on the Drawings, and its strength shall be as specified herein.

concrete for canal lining shall be plastic enough to consolidate well and stiff enough to stay in place on specified slopes over 6" thick compacted, filter as shown on the drawings. Slump shall be in the range of 1 to 3 inches. The water-cement ratio shall be adjusted to achieve the specified slump and strength but shall not exceed 0.45 in any case. The compressive cylinder strength of the concrete (28 days) shall be 3,000 psi and the concrete will be cured by application of a curing compound subject to approval of the Engineer following the submission of a request including supporting procedural methods and documentation by the Contractor. Nominal maximum size of aggregate for concrete in Canal Lining shall be 3/4 inches. The subgrade shall be well moistened but not muddy at the time of placing concrete.

17.3.4.2 Construction Joints

The place where contraction joint is not required but the concrete lining operations are interrupted because of breakdown or delayed by other causes, the edge of the fresh concrete lining shall be bullheaded to a perpendicular surface to the lining along transverse or longitudinal lines. When placing operations are resumed, the surface of the hardened concrete shall be prepared as a construction joint as specified herein. The fresh concrete shall then be placed against the existing concrete to form a permanent bond with the existing concrete.

17.3.4.3 Method of Concrete Lining

The contractor shall carry out concrete lining with the lining machine(s).

- i) Contractor must deploy the concrete lining machine(s) comprising Trimmer and Trimmer discharge conveyor, concrete liners, bottom feed conveyor, concrete curing jumbo, finishing jumbo and working bridge jumbo till the completion of canal lining. The concrete liner component for lining machine set should be capable of concrete lining at least 165 yd³ (125 m³) per hour for 4 inch (100 mm) thick lining layer.
- ii) The concrete batching plants, transit mixers, concrete pump, water chiller plants, crushing plants and other related equipment should manufacture and

maintain the supply of concrete in such a capacity that the concrete liner can yield at least 165 yd³ (125 m³) per hour.

17.3.4.4 Replacement of Damaged/Rejected Concrete Panels

Where a damaged/rejected panel of concrete canal lining is to be replaced, the old concrete shall be removed to the edges of the adjacent panels. The surfaces of the existing concrete shall be prepared as a contraction joint. Fresh concrete shall then be placed against the existing concrete with the full groove contraction joint formed adjacent to the existing concrete. The groove shall then be sealed with elastomeric sealant of approved quality as directed by the Engineer in-Charge.

17.3.4.5 Contraction & Expansion Joints

All Contraction & Expansion joints in general shall conform to the specifications set forth in relevant sections of Chapter 6 (Concrete) of Book II. The joint formed at the end of the day's work in case of continuous lining, shall be made as contraction joint. Expansion joints would be provided where the lining abuts against the structures (where shown on the drawings) or as directed by the Engineer.

17.3.4.6 Curing

Curing of Concrete lining shall conform to the specifications set forth in relevant sections of Chapter 6 (Concrete) of Book II.

17.3.4.6.1 Curing with the help of curing agent

- i) The exposed surfaces of the concrete shall be membrane cured with an approved, white pigmented curing compound which forms a water-retaining membrane on the surfaces of the concrete. Curing compound shall conform to ASTM Designation: C-309. The compound shall be of uniform consistency and quality within each container and from shipment to shipment.
- ii) Curing compound shall be applied to the concrete surfaces by spraying in one coat to provide a continuous, uniform membrane over all areas. Coverage shall not exceed 150 square feet per gallon and on rough surfaces coverage shall be decreased as necessary to obtain the required continuous membrane. Mortar encrustation and fines on surfaces shall be removed prior to application of the curing compound. The repair of all other surface imperfections shall not be made until after application of curing compound.
- iii) When curing compound is used on concrete surfaces where forms are not used, application of the compound shall commence immediately after finishing operations are completed. When curing compound is to be used on concrete surfaces where forms are used, the surfaces shall be moistened with a light spray of water immediately after the forms are removed and shall be kept wet until the surfaces will not absorb more moisture. As soon as the surface film of

moisture disappears but while the surface still has a damp appearance, the sealing compound shall be applied. Special care shall be taken to ensure ample coverage with the compound at edges, corners and rough spots of formed surfaces. When application of the sealing compound has been completed and the coating is dry to touch, any required repair of concrete surfaces shall be performed. Each repair, after being finished shall be moistened and coated with sealing compound in accordance with the foregoing requirements.

- iv) Equipment for applying sealing compound and the method of application shall be in accordance with the relevant provisions of the Bureau of Reclamation Concrete Manual (USBR) Chapter VI. Any sealing membrane that is damaged or that peels from concrete surfaces, prior to 28 days after application, shall be repaired without delay in an approved manner.
- v) Sealing compound will be accepted on Manufacturer's certification of compliance with specifications, but the acceptance on certification shall in no way relieve the Contractor of the responsibility for furnishing the compound meeting specification requirements. Sealing compounds shall be subject to sampling and testing. The Contractor shall provide without charge to the Employer such facilities and assistances as may be necessary to obtain test samples. Sampling will be in accordance with Designation 38 of the 8th Edition of the Bureau of Reclamation Concrete Manual.

17.3.4.7 Tolerances for Concrete Construction

The canal lining shall be built to the lines, grades and dimensions shown on the Drawings. The dimensions shown on the drawings will be subject to such modifications as may be found necessary by the Engineer to adapt to the conditions exposed by the excavation or to meet other site conditions. Where the thickness of any portion of concrete is variable, it shall vary uniformly between the dimensions shown.

17.3.4.8 Tolerances for Canal Lining

Description	Tolerance
Departure from established alignment	± 2 inches on tangents ± 4 inches. on curves
Departure from established profile Grade	± 2 inches Departures set forth above shall be uniform and no correction shall be made in less than 100 ft.
Reduction in thickness of lining	(-1/4) inches of specified thickness provided that average thickness over any

	20 feet length is not less than the specified thickness
Variation from specified height of lining	± 1 inch of established height
Variation from specified width at any height	± 1 inch of established Width

17.3.5 Precast Concrete lining

Lining of Watercourses is generally done by using precast concrete segments available in different sizes depending upon the design flow. Available precast concrete segments are tabulated below along with a typical cross section of the precast concrete segment;

Table 17-1: Available Precast Concrete segments for lining of watercourses

Sr. No.	Segment Size	Top Width (T)	Total Depth (D)	Free Board (FB)	Max. Flow Depth (d)	Flow Area (A)	Eq. Coefficient (a)
	(mm X mm)	(mm)	(mm)	(mm)	(mm)	(sq. m)	
1	360 X 225	360	225	70	155	0.054	0.006944
2	457 X 305	457	305	70	235	0.093	0.005842
3	600 X 360	600	360	70	290	0.144	0.004000
4	540 X 460	640	450	70	390	0.196	0.004492
5	675 X 480	675	450	70	410	0.216	0.004214
6	780 X 530	760	530	70	460	0.269	0.003670
6a	800 X 600	600	600	70	530	0.320	0.003750

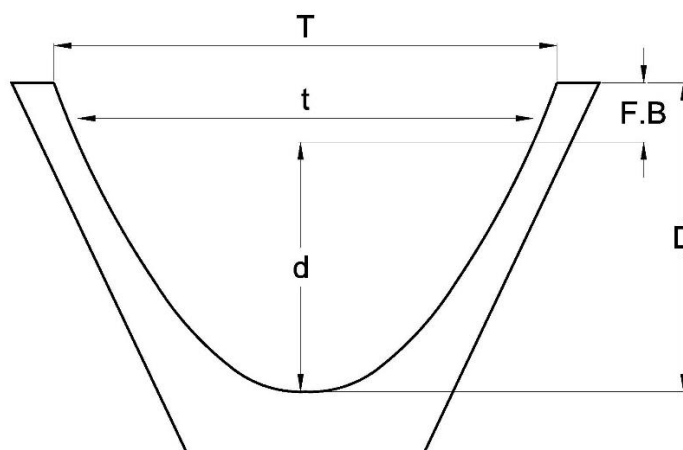

All the material and construction requirements for precast concrete work shall conform to the specifications set forth in Chapter 6 (Concrete) of Book II Part I and in section 17.3.4 above.

17.4 Measurement and Payment

17.4.1 Measurement

The measurements of Lining shall be done along the side slopes and bed of the canal. The unit of measurement for preparation of subgrade shall be per square feet (square meter).

Measurement for crushed stone & filter under the concrete canal lining will be made to the outlines of the crushed stone & filter along the side slopes and bed of the canal and for the thickness shown on the drawings or established by the Engineer. The crushed stone & filter shall be measured by volume. The unit of measurement for crushed stone & filter shall be per cubic feet (cubic meter).

Measurement for canal lining will be made to the outlines of the lining along the side slopes and bed of the canal or along the perimeter of the cross section of the canal and for the thickness shown on the drawings or established by the Engineer. The canal lining shall be measured by volume. The unit of measurement for lining shall be per cubic feet (cubic meter).

The above referred unit rate (s) shall be full compensation for supplying, placing and finishing canal lining including all materials, labour, tools and plants required for the work.

17.4.2 Payment

The payments for the canal lining shall be made at the unit rate (s) of the relevant items given in Chapter 17 of Composite Schedule of Rates (CSR), or in the Bill of Quantities with Specified Unit Rates, where applicable.

Table of Contents

CHAPTER - 18 PILES	2
18.1 General	2
18.1.1 Glossary of Terms	2
18.1.2 Description	2
18.1.3 Material Requirement	3
18.1.4 Construction Requirements	5
18.1.5 Measurement and Payment	20
18.2 Concrete Load Bearing Piles	23
18.2.1 Specifications	23
18.3 Sheet Piling	26
18.3.1 Description	26
18.3.2 Material Requirement	26
18.3.3 Construction Requirement	26
18.3.4 Measurement and Payment	30
18.4 Well Foundation	31
18.4.1 Description	31
18.4.2 Material Requirements	31
18.4.3 Construction Requirement	31
18.4.4 Measurement and Payment	35

CHAPTER - 18**PILES****18.1 General****18.1.1 Glossary of Terms**

Anvil	The part of a power-operated hammer which receives the blow of the ram and transmits it to the pile.
Composite Pile	A pile whose length is made up of more than one material, e.g., timber at bottom and concrete at top.
Dolly	A cushion of hardwood or other material placed on top of the helmet to receive the blows of the hammer.
Driving Cap	A temporary cap placed on top of the pile to distribute the blow over the cross-section and to prevent the head from being damaged during driving.
Drop or Stroke	The distance through which the weight is allowed to fall to strike the head of the pile.
Drop Hammer	A hammer, ram or monkey (which are identical terms) is raised by a winch and allowed to fall by gravity. A single-acting hammer is raised by steam, compressed air, or internal combustion, and allowed to fall by gravity. A double-acting hammer is operated by steam, compressed air, or internal combustion, the energy of its blows being derived mainly from the source of motive power and not from gravity.
Helmet	A temporary steel cap placed on top of a reinforced concrete pile to retain the packing in position and to prevent the head from being damaged during driving.
Pile Bent	A number of piles projecting above the ground up to the bottom of bridge girders. The piles are connected by capping beams on which the bridge decking rests. (Also see under "Trestle bent".)
Ram	The rising and falling part of the hammer which delivers the blow.
Set	The penetration of the pile per blow during the final stages of driving.

18.1.2 Description

This work shall consist of performing all operations in connection with furnishing, driving, cutting off and load testing of piles to obtain the specified bearing value complete in place and strictly in accordance with these Specifications and as shown on the Drawings.

The Contractor shall furnish the precast piles in accordance with an itemized list, which will be provided by the Engineer, showing the number and lengths of all piles. When cast-in-place concrete piles are specified on the Drawings, the Engineer will not furnish the Contractor, an itemized list showing the number and length of piles. When test piles and load tests are required in conformance with sub-items 18.1.4.6 and 18.1.4.7 respectively, the data obtained from such test loads will be used in conjunction with other available subsoil information to determine the number and lengths of piles to be furnished. The Engineer will not prepare the itemized list of piles for any portion of the foundation area until all loading tests representative of that portion have been completed.

The contractor shall provide an outline of his proposed method for constructing large diameter pile when submitting his tender; the proposed method of boring being stated.

Not less than two weeks before the contractor proposes to commence piling, detailed proposal for the piling shall be delivered to the Engineer. These proposals shall include full details of materials, equipment and method to be used in the construction of piles.

If it is proposed to use bentonite slurry, this shall also be described.

Work on piling shall not commence until the contractor's proposals have been approved by the Engineer and communicated to the contractor.

The requirements herein are minimum. Strict compliance with these requirements will not relieve the Contractor of the responsibility for adopting whatever additional provisions may be necessary to ensure the successful completion of the work.

The kind and type of piles shall be as shown on the Drawings and/or as specified. No alternate types or kinds of piling shall be used, except with the written approval of the Engineer each time.

18.1.3 Material Requirement

18.1.3.1 Types of Piles

1. Untreated Timber Piles

Untreated timber piles shall conform to the requirements of AASHO M-168.

2. Treated Timber Piles

Treated timber piles shall conform to the requirements of AASHTO M 133 and M 168. Unless otherwise called for on the drawings, the timber piles shall be treated with creosote according to the Standard AWPA PI of the American Wood-Preservers Association.

3. Reinforced Concrete Cylindrical Piles

Diameter of reinforced concrete piles shall be as shown on the Drawings and may or may not have permanent lining, as shown on the drawing.

Reinforcing Steel shall conform to the requirements of Steel Reinforcement.

Concrete shall meet all the requirements for specified Class as provided and shall be of Class D unless otherwise specified.

4. Structural Steel Piles

Structural steel piles shall be rolled steel sections of the type, weight and shape called for on the Drawings. The piles shall be structural steel conforming to the requirements of ASTM A 7 and ASTM A 36, except that steel produced by the Acid-Bessemer process shall not be used.

The steel piles shall be coated with red lead paint conforming to AASHTO M 72 as instructed by the Engineer, unless otherwise specified.

5. Pre-Cast Concrete Piles

Concrete for piles shall meet all the requirements for the specified class as provided. The concrete shall be of Class-01 unless otherwise specified.

Reinforcing Steel shall conform to the requirements of Steel Reinforcement. Prestressed concrete piles shall conform to Prestressed Concrete Structures.

Precast piles shall be made in accordance with the Drawings, and reinforcement shall be placed accurately and secured rigidly in such manner as to ensure its proper location in the completed pile. The concrete cover as measured to the outside face of ties or spirals shall not be less than five (5) cm.

The piles shall be cast separately or, if alternate piles are cast in a tier, the intermediate piles shall not be cast until four (4) days after the adjacent piles have been poured. Piles cast in tiers shall be separated by tar paper or other suitable separating materials. The concrete in each pile shall be placed continuously. The completed piles shall be free from stone pockets, porous spots, or other defects, and shall be straight and true to the form specified. The forms shall be true to line and built of metal, plywood, or dressed lumber. A two and half (2.5) cm chamfer strip shall be formed on all edges. Forms shall be watertight and shall not be removed within twenty-four (24) hours after the concrete is placed. Piles shall be given a surface finish according to Concrete Surface Finishing.

Piles shall be cured in accordance with the requirements of Curing Precast Concrete Piles. Piles shall not be moved until the tests indicate a compressive strength of eighty (80) percent of the design twenty-eight (28) days compressive strength and they shall not be transported or driven until the tests indicate a compressive strength equal to the design twenty-eight (28) days compressive strength.

When concrete piles are lifted or moved, they shall be supported at the points shown on the Drawings or if not so shown, as instructed by the Engineer.

18.1.3.2 Pile Shoes

Pile shoes when required shall be of the design as called for on the Drawings or by the Engineer.

18.1.3.3 Pile Splices

Materials for pile splices, when splicing is allowed, shall be of the same quality and characteristics as the materials used for the pile itself and shall follow the requirements given on the Drawings unless otherwise directed by the Engineer.

18.1.4 Construction Requirements

18.1.4.1 Driven Piles (Displacement Method)

1. location and Site Preparation

Piles shall be used where indicated on the Drawings or as directed by the Engineer. All excavations for the foundation in which the piles are to be driven shall be completed before the driving is begun, unless otherwise specified or approved by the Engineer. After driving is completed, all loose and displaced materials shall be removed from around the piles by hand excavation, leaving clean solid surfaces to receive the concrete for foundations.

2. Determination of Pile Length

The criteria for pile length and bearing capacity will be determined by the Engineer according to the results from test piles and load tests. The piles shall be driven to such depths, that the bearing loads indicated on the Drawings are obtained. The criterion for pile length may be one of the following: -

- Piles in sand and gravel shall be driven to a bearing value determined by use for the pile driving formula or as decided by the Engineer.
- Piles in clay shall be driven to the depth ordered by the Engineer. However, the bearing value shall be controlled by the appropriate pile driving formula if called for by the Engineer.
- Piles shall be driven to refusal on rock or hard layer when so ordered by the Engineer.

The contractor shall be responsible for correct pile lengths and bearing capacities according to the criteria given by the Engineer.

3. Pile Driving

All piles shall be driven accurately to the vertical or the batter as shown on the drawings. Each pile shall, after driving, be within fifteen (15) cm from the theoretical location underneath the pile cap or underneath the superstructure in the case of pile bents. All piles pushed up by the driving of adjacent piles or by any other cause shall be driven down again.

Piles shall be used only in places where a minimum penetration of three (3) meters in firm materials, or five (5) meters in soft materials, can be obtained. When a soft stratum overlies a hard stratum, the piles shall penetrate to hard material up to a sufficient distance to fix the ends rigidly. All pile driving equipment is subject to the Engineer's approval. The Contractor is responsible for sufficient weight and efficiency of the hammers to drive the piles down to the required depth and bearing capacity. Hammers shall be gravity hammers, single acting steam or pneumatic hammers

or diesel hammers. Gravity hammers shall not weigh less than sixty (60) percent of the combined weight of the pile and driving head and not less than 2,000 Kg. The fall shall be adjusted so as to avoid injury to the pile and shall in no case exceed one (1) m for timber and steel piles and one half (0.5) M for concrete piles unless otherwise specified or approved by the Engineer. The plant and equipment furnished for steam hammers shall have sufficient capacity to maintain, under working conditions, the pressure at the hammer specified by the manufacturer. The boiler or pressure tank shall be equipped with an accurate pressure gauge and another gauge shall be supplied at the hammer intake to determine the drop-in pressure between the gauge and the hammer. When diesel hammers are used, they shall be calibrated with test piling and/or test loads in accordance with 18.1.4.7.

Water jets shall be used only when permitted in writing by the Engineer. When water jets are used, the number of jets and the nozzle volume and pressure shall be sufficient to erode the material adjacent to the pile freely. The jets shall be shut off at a depth not less than three (3) M before final tip elevation is reached, and the piles driven solely by hammer to final penetration as required by the Engineer.

Piles shall be supported in line and position with leads while being driven. Pile driving leads shall be constructed in such a manner as to afford freedom of movement of the hammer, and shall be held in position by guys or steel braces to ensure rigid lateral support to the pile during driving. The leads shall be of sufficient length to make the use of a follower unnecessary, and shall be so designed as to permit proper placing of batter piles. The driving of piles with followers shall be avoided if practicable and shall be done only under written permission from the Engineer.

The method used in driving piles shall not subject them to excessive and undue abuse producing crushing and spalling of the concrete, injurious splitting and brooming of the wood, or deformation of the steel. Manipulation of piles to force them into proper position, if considered by the Engineer to be excessive, will not be permitted.

The pile tops shall be protected by driving heads, caps or cushions in accordance with the recommendations from the manufacturer of the pile hammer and to the satisfaction of the Engineer. The driving head shall be provided to maintain the axis of the pile in line with the axis of the hammer and provide a driving surface normal to the pile.

Full-length piles shall be used where practicable. Splicing of piles when permitted shall be in accordance with the provisions of splicing of piles. All piles shall be continuously driven unless otherwise allowed by the Engineer.

4. Pile Driving Formula

Pile driving formulas may be used to determine the number of blows of hammer per unit of pile penetration needed to obtain the specified bearing capacity for piles driven in the sub-soils at the site. Piles shall be driven to a final resistance as indicated on the plans determined by the following formula: -

For Drop Hammer

$$Q_{all} = WH/[6(S+2.5)]$$

For single-acting steam or air hammers and for diesel Hammers having unrestricted rebound of rams.

$$Q_{all} = \frac{WH}{6(S+0.25)} \quad (\text{Use when driven weights are smaller than striking weights})$$

$$Q_{all} = \frac{WH}{6\{S+0.25(WD/WS)\}} \quad (\text{Use when driven weights are smaller than striking weights})$$

For double-acting steam or air hammers and diesel hammers having enclosed rams.

$$Q_{all} = \frac{E}{6(S+0.25)} \quad (\text{Use when driven weights are smaller than striking weights})$$

$$Q_{all} = \frac{E}{6\{S+0.25(WD/WS)\}} \quad (\text{Use when driven weights are smaller than striking weights})$$

In the above Formulas: -

Q_{all} = Allowable pile load in kilograms.

W = Weight of striking parts of hammer in kilograms.

H = The height of fall in centimeter for steam, and air hammers and the observed average height of fall in centimeters of blows used to determine penetration for diesel hammers with unrestricted rebound of hammer.

S = Average net penetration per blow in centimeters for the last 10 to 20 blows of steam air, or diesel hammer or for the last 15 centimeters of driving for a drop hammer.

E = The actual energy delivered by hammer per blow in Kilogram – Centimeter.

WD = Driven weights in Kilograms.

Note: Ratio of driven weights to striking weights should not exceed three.

WS = Weight of striking parts in kilograms.

Modification of Basic Pile Driving Formula: -

- For piles driven to and seated in rock as high capacity end bearing piles: Drive to refusal (approximately four (4) to five (5) blows for the last 0.625 centimeters of driving). Re-drive open end pipe piles repeatedly until resistance for refusal is reached within two and half (2.5) centimeters of additional penetration.
- For piles driven through stiff compressible materials unsuitable for pile bearing to an underlying bearing stratum: Add blows attained before reaching bearing stratum to required blows attained in bearing Stratum.
- For piles into limited thin bearing stratum: Drive to predetermined tip elevation and determine allowable load by load test.

The bearing power as determined by the appropriate formula in the foregoing list will be considered effective only when it is less than the crushing strength of the pile other recognized formula for determining pile bearing power may be used when given in special specification. However, it shall be understood that the relative merits and reliability of any of the pile formula can be judged only on the basis of comparisons with the results of load tests.

18.1.4.2 Cast in Place Piles

Piles, cast-in-place. shall consist of one of the types either shown on the drawing and/or as specified. The term shaft wherever used in this section, shall mean either piles or shafts.

18.1.4.2.1 Working Drawings

At least 4 weeks before work on shafts is to begin, the Contractor shall submit to the Engineer for review and approval, an installation plan for the construction of drilled shafts. The submittal shall include the following: -

- List of proposed equipment to be used including cranes, drills, augers, bailing buckets, final cleaning equipment, desanding equipment, slurry pumps, sampling equipment, tremies or concrete pumps, casing etc.
- Details of overall construction operation sequence and the sequence of shaft construction in bents or groups.
- Details of shaft excavation methods.
- When slurry is required, details of the method proposed to mix, Circulate and desand slurry.
- Details of methods to clean the shaft excavation.
- Details of reinforcement placement including support and centralization methods. Details of concrete placement, curing and protection.
- Details of any required load tests.
- Other information shown on the plans or requested by the Engineer.

The Contractor shall not start the construction of drilled shafts for which working drawings are required until such drawings have been approved by the Engineer. Such approval will not relieve the Contractor of responsibility for results obtained by use of these drawings or any of his other responsibilities under the contract.

18.1.4.2.2 Fabrication of Permanent Lining

If shown on the drawings, the contractor shall provide a permanent lining suitably formed of ten (10) mm minimum thickness mild steel plate complying with B.S. 4360. The plates shall be cut and rolled to the inner diameter not less than the nominal diameter of the pile or such larger diameter as to allow the requisite pile diameter hole in the unlined length of pile. The rolled plates shall be connected by full penetration butt welds generally complying with B.S. 5133. No more than three (3) longitudinal seam welds shall be employed in any one cross-section and such welds shall be staggered in position in the cross-section between one length and the next. The dimensional accuracy of the lining shall be as stated the drawings.

In the case of steel shells or pipes, after being driven and prior to placing reinforcing steel and concrete therein, the steel shells or pipes shall be examined for collapse or reduced diameter at any point. Any shell or pipe, which is improperly driven or broken or shows partial collapse to such an extent as to materially decrease its bearing value will be rejected. Rejected shells or pipes shall be removed and replaced, or a new shell or pipe shall be driven adjacent to the rejected one. Rejected shells or pipes, which cannot be removed, shall be filled with lean concrete by the Contractor at his expense.

18.1.4.2.3 Piles Cast in Drill-Bore hole

1. Boring Procedure

The method and equipment of boring generally either the dry method, wet method, temporary casing method or permanent casing method shall be one which maintains stability, verticality or

batter (as shown on the Drawing) of the wall and base of borehole by the use of temporary casing and/or bentonite slurry.

All holes shall be drilled to the tip elevation shown on the Drawings, unless otherwise specified or approved by the Engineer. Rejected boreholes shall be filled with lean concrete by contractor at his expense.

The method shall be such that allows soil samples to be taken and in site soil test, (if required) to be carried out during or ahead of boring operations. The method/procedure used in execution of borehole and other operations shall not be such as to cause vibrations resulting in damage to completed or partially completed piles or to adjacent structures, services or other property. The procedure shall not be such as to cause harmful loosening or softening of soil outside the pie that has to be filled with concrete. The equipment used for execution of borehole shall be adequate to ensure that each pile penetrates to the required founding level.

a. Equipment's for Boring

- Cluster Drill
- Continuous flight auger
- Rotary Drilling Rigs

b. Boring Methods

Most common boring methods are Kelly drilling, continuous flight auger drilling, full displacement drilling, double rotary drilling, drilling with hammer grab, reverse circulation air injection drilling and down-the-hole drilling.

i. Kelly Drilling

Kelly drilling belongs to the most common dry rotary drilling methods. The process is suitable for nearly all types of soil and rock. The soil shall be conveyed with relatively short rotary drilling tools, such as augers, core barrels, buckets and special drilling tools. A typical element of this drilling method is the drill rod, the so-called Kelly bar, which is telescopic and facilitates large drilling depths.

ii. Full Displacement Drilling

Full displacement drilling is a modified version of continuous flight auger drilling and is exclusively used for producing cast-in-place piles. The surrounding soil shall only displace and almost no drill cuttings shall be conveyed to the surface. Instead of a continuous auger a smooth casing shall be used. At the lower end the casing shall be fitted with a so-called displacement body.

iii. Double Rotary Drilling

Double rotary drilling combines continuous flight auger drilling with a continuous casing. Casing and auger (inside the casing) shall be simultaneously installed and extracted. Double rotary drilling shall be applied for the production of cast-in-place piles and for predrilling.

iv. Continuous flight auger drilling

Continuous flight auger drilling belongs to the dry rotary drilling methods. It is suitable for predrilling as well as for the installation of cast-in-place piles. The soil (under certain conditions also rock) shall be loosened and conveyed continuously using a continuous flight auger. The borehole wall shall be supported by the auger flights filled with drill cuttings.

v. Down-the-hole drilling

In down-the-hole drilling a drill rod should be fitted with a hammer at its lower end. The hammer, which is mounted on the drill bit, shall be activated through the addition of compressed air and driven into the ground simultaneously rotating and impacting. A flushing current collects the loosened drill cuttings and conveys them upwards. This method shall mainly apply for hard to very hard rock and/or for penetrating large boulders.

vi. Drilling with bored pile grab

Drilling with bored pile grab is one of the oldest dry drilling methods and is still common today. Depending on the tools used, e.g. bored pile grab, chisel or special tools hanging on a duty cycle crawler crane, the soil should be loosened either by cutting or impact driving. This method should apply, for instance, for well drilling with small drilling diameter or for the production of cast-in-place piles with sometimes very large diameters.

vii. Reverse circulation air injection drilling

Reverse circulation air injection drilling is a method of hydraulic circulation drilling to produce boreholes of up to approx. 3.2m diameter. In most cases drilling with hammer grab should first be carried out. The soil shall be conveyed using the mammoth pump principle. The flushing current flows in the annular space between borehole wall and drill rod to the bottom of the borehole, from where the flushing current rises inside the drill rod conveying the cuttings with it.

viii. Reverse Circulation Mud Rotary Drilling

Reverse circulation rotary drilling is a variant of the mud rotary method, in which drilling fluid flows from the mud pit down the borehole outside the drill rods and passes upward through the bit. Cuttings are carried into the drill rods and discharged back into the mud pit. Reverse circulation requires a lot of water and sediment-handling, as the boreholes are large in diameter. Stability of the borehole depends on the positive pressure from the fluid in the borehole annulus. If the positive pressure is not sufficient, the borehole wall or parts of it might collapse, trapping the drill string. For reverse circulation rotary drilling, the drilling fluid can best be described as muddy water rather than drilling fluid; drilling fluid additives seldom are mixed with the water to make a viscous fluid. Suspended clay and silt that re-circulates with the fluid mostly shall be fine materials picked up from the formations as drilling proceeds. Occasionally, low concentrations of a polymeric drilling fluid additive should be used to reduce friction, swelling of water-sensitive clays, and water loss. Because fewer drilling muds are used, no wall cake should be created, and the stabilization by the borehole fluid shall be needed. To prevent caving of the hole, the fluid level should be kept at ground level at all times even when drilling is suspended temporarily to prevent a loss of hydrostatic pressure in the borehole. The hydrostatic pressure of the water column, plus the

velocity head of the downward moving water outside the drill pipe are what support the borehole wall. Erosion of the wall usually is not a problem because velocity in the annular space is low. A considerable quantity of makeup water usually is required and must be immediately available at all times when drilling in permeable sand and gravel. Under these conditions, water loss can suddenly increase, and, if this causes the fluid level in the hole to drop significantly below the ground surface, caving usually is the result. Water loss can be addressed by the addition of clay additives, but this action is only taken as a last resort. Often, to aid the upward movement of water through the drill string, air is injected, lifting the contents to the surface. Another reason to use air is the fact that the suction pump lift is limited in its capacity to create enough vacuum to start up the water movement after a rod change. When air lifting is used to assist in reverse mud drilling, this method becomes similar to the reverse air rotary method. Reverse mud is a cost-effective method for drilling borehole 24-inches and greater, and is most successful in unconsolidated formations.

c. Use of Casing

Suitable casings shall be furnished and placed when required to prevent caving of the hole before concrete is poured. Casing, if used in drilling operations shall be removed from the hole as concrete is poured unless otherwise specified. The bottom of the casing shall be maintained not less than fifty (50) cm below the top of the concrete during withdrawal and pouring operations unless otherwise permitted by the Engineer. Separation of the concrete during withdrawal operations shall be avoided.

d. Reinforcement

Reinforcement if called for shall conform to the requirements of steel reinforcement. The steel shells/pipes shall be of sufficient strength and rigidity to permit driving to the required bearing value or depth without injury. The steel may be either cylindrical or tapered, step tapered or a combination, plain, circular or fluted. All types shall conform to the corresponding ASTM standards. The minimum average tensile strength of steel shall be 3500 Kg/sq.cm (50,000 Psi). When called for on the Drawings or by the Engineer, the steel shells/pipes shall be factory coated on both interior or exterior surfaces by red lead paint conforming to AASHTO M-72 or as stated in the special specifications. The coating shall not cause any hindrance while assembling the pile section during welding operations.

2. Temporary Casing Method

The temporary casing of appropriate diameter for locating the pile and piloting the borehole shall be pitched at the exact locations as given on the drawings to ensure that the casing when sunk is within the specified tolerances. The casing shall be sunk to sufficient depth by approved methods. The depth shall be at least sufficient to prevent the ingress of alluvium or other loose materials into the bore when executed below the bottom level of the casing. In addition, the depth shall be such as the contractor considers necessary for the stability of the casing and/or temporary works system during construction in general and for the following conditions and operations in particular during all conditions of river current which may occur during the period of works: -

- Open temporary casing to ensure against blow-in of soil.

- Concreting of the pile, until temporary casing is extracted.

a. Safety of Casing

The contractor shall take all such measures and provide such strengthening and bracing as is necessary and to the approval of the engineer to ensure that the temporary casing is not disturbed, overturned, over-stressed or under-eroded in any condition of temporary casing shall be such that it will not disturb the freshly cast concrete and/or permanent lining and/or reinforcement. Where the use of temporary casing is approved for the purpose of maintaining the stability and over-rapid withdrawal of the boring tools which could lead to excessive removal of soil and water and disturbance of the surrounding ground and when boring through any permeable stratum (including silt), the water level in the boring shall be maintained between one (1) meter and two (2) meters above the external water level, unless the engineer directs otherwise. The temporary casings shall be free from significant distortion and of uniform cross sections throughout each continuous length. During concreting they shall be free from encrusted concrete or any internal projections which might prevent the proper formation of the piles.

b. Permanent Casing Method

The permanent casing construction method shall be used when required by the plans. This method consists of driving or drilling a casing to a prescribed depth before excavation begins. If full penetration cannot be attained, the Engineer may require either excavation of material within the embedded portion of the casing or excavation of a pilot hole ahead of the casing until the casing reaches the desired penetration. In some cases, over-reaming to the outside diameter of the casing may be required in order to advance the casing.

The casing shall be continuous between the elevations shown on the plans. Unless shown on the plans, the use of temporary casing in lieu of or in addition to the permanent casing shall not be used except when authorized by the Engineer in writing.

After the installation of the casing and the excavation of the shaft is complete, the casing shall be cutoff at the prescribed elevation and the reinforcing steel and shaft concrete placed within the portion of the casing left in place.

3. Bentonite Slurry

Where the use of bentonite slurry is approved for the purpose of maintaining the stability of the walls and base of bore, the contractor's proposals in accordance with (sub clause vi) hereof shall include details of the slurry. These shall include inter-alia: -

- The source of the bentonite
- The constitution of the slurry.
- Specific gravity, viscosity, shear strength and PH value of slurry.
- The methods of mixing, storing, placing, removal and recirculating the slurry.
- The provision of stand-by equipment.

Tests shall be carried out to ensure that the proposed constitution of the slurry is compatible with the ground water. Proposals for the constitution and physical properties of the slurry shall include

average, minimum and maximum values. The specific gravity of the slurry shall not be less than one and three hundredth (1.03) in any case at any time. The contractor shall use additives where necessary to ensure the satisfactory functioning of the slurry.

a. Manufacturers Certificate

A manufacturers certificate showing the properties of the bentonite powder shall be delivered to the Engineer for each consignment delivered to site. Independent tests shall be carried out at laboratory approved by the Engineer on samples of bentonite frequently.

b. Tests on Bentonite Slurry

The Contractor shall carry out tests during the course of the piling to check the physical properties of the bentonite slurry in the works. These tests shall include, inter-alia, density, viscosity, shear strength and PH tests. The test apparatus and test methods shall be those given in "Recommended Practice Standard by American Petroleum Institute, New York City, 1957, reference API RP29. Section- I, II and VI.

The frequency of tests shall be that which the Contractor considers necessary to ensure that the bentonite slurry is in accordance with his proposals and as such other times as the Engineer may direct.

Should the physical properties of any bentonite slurry deviate outside the agreed limits, such slurry shall be replaced, irrespective of the number of times it has been used by new bentonite slurry of correct physical properties.

Adequate time shall be allowed for proper hydration to take place. consistent with the method of mixing, before using slurry in the works.

c. Precautions

- The Contractor shall control the bentonite slurry so that it does not cause a nuisance either on the site or adjacent waterways or other areas. After use it shall be disposed in a manner to the approval of the Engineer.
- The level of the slurry in the bentonite shall be maintained so that the internal fluid pressure always exceeds the external water pressure.
- If chiseling is used when boring through hard strata or to overcome obstructions, the stability of the excavation shall be maintained by methods acceptable to the Engineer.

4. Excavation from Boreholes

The soil and debris from inside the pile boreholes shall be removed by bucket, augur or circulating bentonite slurry provided that no jetting at the foot of the borehole shall be permitted. Methods of excavation, which in the opinion of the Engineer may damage the permanent lining of the pile, shall not be employed. Should the excavation reveal any soil stratum below the bottom of a pile which-is, in the opinion of the Engineer, unsuitable for supporting the loads that will be imposed on it. the Contractor shall remove all such sub soil stratum to the satisfaction of the Engineer and

shall lengthen the pile if necessary and cost of any such lengthening shall be paid as per this contract.

Excavation shall be carried out as rapidly as possible in order to reduce to a minimum the time in which any strata are exposed to the atmosphere. bentonite slurry or water. In any case, a pile shall not remain unfilled with concrete for period exceeding eighteen (18) hours after completion of borehole. The materials from pile excavation shall be disposed so that the same does not Interfere with any part of the permanent works of this project. in neat and workmanlike manner.

5. Samples and Tests

The Contractor shall take soil samples as given below or as directed by the Engineer to the designed tip elevation of the pile and shall carry out in-situ Standard Penetration tests within, and ahead of borehole on the line of vertical axis of the pile at these locations after one and half (1.5) meter interval. The costs of tests and collection of samples shall be deemed to be included in the unit rates quoted by the Contractor. Each disturbed sample shall, as far as possible, be truly representative of the grading of in-situ soil at the point from which it is taken, without contamination by other material. It shall be approximately five (5) Kg in weight and shall be placed in a strong air tight container immediately after its removal from the sampler. The container shall be sealed as soon as the sample has been placed in and shall be taken to the site laboratory for grading, moisture content and Atterberg Limits tests. The apparatus and procedure for the Standard Penetration Test shall be in accordance with the provisions of ASTM D 1586 Penetration Test and split-barrel sampling of soils and/or ASTM D 1587 thin-walled sampling of soils, (except insofar as any such provisions may conflict with other requirements of the contract).

6. Limitations of Boring Sequence

Piles shall be constructed in such a manner and sequence as to ensure that no damage is sustained by piles already constructed in adjacent positions. The Contractor shall submit to the Engineer for his approval a program showing sequence of construction of various piles.

7. Tolerances

Following construction tolerances shall maintained: -

- The drilled shaft shall be within 3 inches of the plan position in the horizontal plane at the plan elevation for the top of the shaft.
- The vertical alignment of the shaft excavation shall not vary from the plan alignment by more than 1/4 inch per foot of depth.
- After all the shaft concrete is placed, the top of the reinforcing steel cage shall be no more than 6 inches above and no more than 3 inches below plan position.
- When casing is used, its outside diameter shall not be less than the shaft diameter shown on the plans When casing is not used, the minimum diameter of the drilled shaft shall be the diameter shown on the plans for diameters 24 inches or less, and not more than 1 inch less than the diameter shown on the plants for diameters greater than 24 inches.
- The bearing area of bells shall be excavated to the plan bearing area as a minimum. All other plan dimensions shown for the bells may be varied, when approved, to accommodate the equipment used.

- The top elevation of the shaft shall be within 1 inch of the plan top of shaft elevation.
- The bottom of the shaft excavation shall be normal to the axis of the shaft within 3/4 inch per foot of shaft diameter.

8. Inspection

After the borehole has reached its final stipulated positions, after the samples have been taken out, as required by the Engineer, and the borehole has been completely cleaned of all loose matter and otherwise made ready to receive the reinforcement and thereafter the concrete, the contractor shall so inform the Engineer. The Engineer shall inspect the soil samples and test results thereon, check the elevation of the bottom of the borehole and the amount and direction, if any, by which the top of the casing is out of position, or out-of-plumb having satisfied himself on these and on any other points which he may consider relevant shall sign permission authorizing the Contractor to proceed with the placing of the reinforcement. The Contractor shall under no circumstances proceed with the placing of reinforcement or with the subsequent concreting without having first obtained the authority signed separately for each and every borehole by the Engineer.

9. Pile Reinforcement

The reinforcement for each pile shall be assembled and securely tied by means of binding wire and by welded reinforcement rings of twenty-five (25) mm diameter bar as shown on the drawings, in such a manner as to form a rigid cage. The required concrete cover to the reinforcement shall be maintained by suitable spacers securely attached to the reinforcement and of sufficient strength to resist damage during handling of the reinforcement cage into the pile. The distance between the spacers shall be such that the required cover is maintained throughout and that there is no displacement of the reinforcement cage in the course of the concreting operation. Should the Contractor prefer to lower the reinforcement cage assembly into the borehole in sections, he may do so provided the same lapping requirements as for assembly on the ground are followed, namely, the longitudinal reinforcement shall be lapped as shown on the drawings and the spiral reinforcement shall be doubled over the lap zones. Spacers maintaining concrete cover shall be located immediately below and above the laps at 4 points spaced around the cage.

18.1.4.3 Concreting of Piles

In general, the General specification shall be followed, however, the following particular requirement shall be observed.

1. Materials

- Compressive strength of concrete in piles shall be of class A3 as prescribed in requirements, except if otherwise indicated.
- Suitable retarder, plasticizer may be added as approved by the Engineer.
- The Contractor shall submit the detailed proposed additive for approval. which shall be approved after laboratory trial mix results. The dosing of retarders shall ensure initial setting time of not less than five (5) hours corresponding to the ambient temperature at which the concreting is proposed to be carried out.

2. Commencement of Concreting

Prior to placing any concrete: -

- Any heavy contaminated bentonite slurry, which could impair the free flow of concrete from the tremie pipe, shall be removed.
- Any loose or soft material/water soil shall be removed from the bottom of the bore by methods acceptable to the Engineer.

The Contractor shall not proceed with the concreting of the pile until the Engineer gives specific permit to do so after satisfying himself of the: -

- Adequacy of the Contractors equipment and arrangement.
- Proficiency of his personnel.
- Cleanliness of the borehole.

Contractors shall have a suitable lighting arrangement at all times for inspecting the entire length of the shells, pipe or hole before placing the reinforcing steel or concrete. Prior to the concreting a pile, sample of slurry shall be taken from the base of the bore hole using an approved sampling device and its specific gravity shall be determined.

3. Placing of Concrete

The tremie shall be of not less than two hundred and fifty (250) mm Diameter made of watertight construction. The means of supporting the tremie shall be such as to permit the free movement of the discharge end in the concrete in the pile. The tremie pipe shall be fitted with travelling plug, which shall be placed at the top of the pipe before charging the tremie pipe with concrete as barrier between the concrete and water or bentonite slurry, so as to prevent water or bentonite slurry entering the tube and mixing with the concrete. The tremie shall be carefully lowered into the borehole so that the end of the tube shall rest at about one hundred and fifty (150) mm above the bottom of the borehole, with reinforcement in the borehole and the hopper end of the tremie tube shall be filled with concrete as aforesaid. It shall be slightly raised so that when the concrete reaches the bottom it flows out of the lower end of the tube, and fills the bottom of the borehole. Thereafter, the rate of withdrawal of the tremie shall be gradual so as to ensure the end of the tremie pipe is always one and half (1.5) meters below the top of the concrete in the borehole. An allowance shall be made for the top five hundred (500) mm of concrete in borehole during concreting being unsatisfactory. when the next batch is placed in the hopper the tremie shall be slightly raised but not out of the concrete at the bottom, until the batch discharges to the bottom of the upper. This operation shall be controlled by calculating the volume of concrete required to fill one linear meter of pile and then by measuring the rate of withdrawal of the tube corresponding to the volume of the batch in the hopper. The flow shall then be retarded by lowering the tube. The depth of the concrete in borehole shall be measured at intervals to keep a constant check that the tremie pipe bottom is immersed in concrete.

Concreting in each pile shall be carried out in a continuous operation without stoppages until the pile has been completed. If the bottom of the tremie pipe ceases to be immersed in the body of

the concrete in the pile and the seal is broken, concreting shall cease immediately and such remedial measures as the Engineer may accept or direct shall be carried out. The contractor shall take precautions to ensure that the concrete is free of voids and shall prevent the entry of water and/or collapse of soil into concrete. If any soil or other deleterious or extraneous materials fall into any pile excavation prior to or during concreting it shall be removed immediately. Concreting shall continue until the concrete has reached an elevation five hundred (500) mm higher than the designated pile cut off level shown on the drawings or as otherwise directed by the Engineer.

The concrete shall be placed in one continuous operation from tip of cut-off elevation and shall be carried out in such a manner as to avoid segregation. The method of placing the concrete and the consistency (slump) shall conform to the requirements of concrete or to the satisfaction of the Engineer. No shell or pipe shall be filled with concrete until all adjacent shells, pipes or piles within a radius of three (3) M or five (5) times the pile diameter, whichever is greater, have been driven to the required resistance. After a shell or pipe has been filled with concrete, no pile shall be driven within seven (7) meters thereof until at least seven (7) days have elapsed.

18.1.4.4 Withdrawal of Temporary Casing

If the method of construction involves partial withdrawal of temporary casing as concreting proceeds, a sufficient head of concrete shall be maintained above the bottom of the temporary casing to ensure that no voids are formed within the pile and to prevent the entry of ground water and to prevent the collapse of soil into the concrete.

If such entry or collapse should occur; the temporary casing shall be re driven before the concrete has set and all defective concrete shall be removed or the construction of the pile shall be abandoned, in which case the provision of the clause herein which refers to "Defective Piles" shall apply. The withdrawal of the temporary casing shall be carried out before the adjacent concrete has taken its initial set.

The method and timing of withdrawal must be such as to ensure that the space between the pile and the surrounding ground shall be filled with concrete.

18.1.4.5 Cutting of Piles

Tops of piles shall be embedded in the concrete footing as shown on the drawings.

Concrete piles shall, when approved by the Engineer, be cut off at such a level that at least five (5) cm of undamaged pile can be embedded in the structure above. If a pile is damaged below this level, the Contractor shall repair the pile to the satisfaction of the Engineer. The longitudinal reinforcement of the piles shall be embedded in the structure above to a length equal to at least (40) times the diameter of the main reinforcing bars. The distance from the side of any pile to the nearest edge of the footing shall not be less than twenty (20) cm.

When the cut-off elevation for a precast concrete pile, steel shell, pipe or for a cast-in-place concrete pile is below the elevation of the bottom of the pile cap, the pile may be built up from the butt of the pile to the elevation of the bottom of the cap by means of a reinforced concrete construction according to requirements, if approved by the Engineer.

Cut-offs of structural steel piles shall be made at right angles to the axis of the pile. The cuts shall be made in dean, straight lines and any irregularity due to cutting or burning shall be leveled off with deposits of weld metal prior to placing bearing caps.

18.1.4.6 Test Pile

Test piles which are shown on the Drawings or ordered by the Engineer shall conform to the requirements for piling as specified and shall be so located that they may be cut-off and become a part of the completed structure.

Test piles to be load tested in accordance with 18.1.4.7 shall be driven in locations determined by the Engineer. These piles shall not be utilized in the structure unless otherwise directed.

Test piles driven by the Contractor for his own use in determining the lengths of piles to be furnished may be so located and they may be cut-off and become a part of the completed structure provided that such test piles conform to the requirement for piling in these specifications.

Any pile, which after serving its purpose as a test pile is found unsatisfactory for utilization in the structure, shall be removed if so, ordered by the Engineer, or if approved by the Engineer it shall be cutoff below the ground line and footings, but such approval does not in any way relieve the Contractor of his responsibilities.

Test piles shall generally be driven with the same equipment that is to be used for driving foundation piles. When required, the ground shall be excavated to the elevation of the bottom of the footing before the test pile is driven when diesel hammers are to be used for driving end bearing piles, or friction piles where the bearing capacity shall be checked by pile driving formulas, the Contractor shall in advance carry out test piling or load tests to determine the energy developed by the hammer. The Contractor may elect one of the following methods for the calibration: -

- By test driving the same type of piles successively with diesel hammer and gravity or single acting hammer, or by driving two different piles with diesel hammer and gravity or single acting hammer respectively.
- By driving test piles to a depth determined by the Engineer and load testing the same piles in accordance with 18.1.4.7.
- Calibration tests shall be made at least at two different sites until the results are satisfactory to the Engineer.

Calibration of diesel hammers may not be required if the hammer has been previously calibrated under soil conditions and for the same size and type of pile, provided that the calibration data is accepted by the Engineer.

18.1.4.7 Load Test

A load test shall consist of the application of a load equal to a minimum of 2 times the specified bearing capacity or as otherwise provided for herein or as directed by the Engineer. Load tests shall be made where specified and/or where called for by the Engineer. Unless otherwise permitted by the Engineer, the load tests shall be completed before the remaining piles in the same structure are driven or cast.

Load tests shall be made by methods approved by the Engineer. The Contractor shall submit to the Engineer detailed plans of the loading system and apparatus he intends to use at least three

(3) weeks in advance. The apparatus shall be so constructed as to allow the various increments of the load to be placed gradually without causing vibration to the test piles. Tension anchor piles if used, shall be of a design and driven to a depth satisfactory to the Engineer. Steel shells or piles whose walls are not of adequate strength to withstand the test loading when empty, shall have the required reinforcement and concrete placed before loading. The load test shall not be started until the concrete has attained a minimum compressive strength of ninety-five (95) percent of the design twenty-eight (28) days compressive strength. If he so elects, the Contractor may use high early strength cement in the concrete of the load test pile and the tension piles.

Suitable approved apparatus for determining accurately the load on the pile and the settlement of the pile under each increment of load shall be supplied by the Contractor. The apparatus shall have a working capacity of three times the design load for the pile being tested. Reference points for measurement of pile settlement shall be sufficiently away from the test pile to preclude all possibility of disturbance.

All pile load settlements shall be measured by adequate devices, such as gauges, and shall be checked by means of an Engineers level. Increment of deflection shall be read just after each load increment is applied and at 15-minute intervals thereafter. The safe allowable load shall be considered as 50 percent of the load which, after 48 hours of continuous application, has caused not more than 6 mm of permanent settlement, measured at the top of the pile.

The first load to be applied to the test pile shall be 50%, of the pile design load and the first increment shall be up to the pile design load by applying additional loads in three equal increments. A minimum period of 2 hours shall intervene between the application of each increment, except that no increment shall be added until a settlement of less than one tenth (0.1) mm is observed for a 15-minute interval under the previously applied increment. If there is a question as to whether the test pile will support the test load, the load increments shall be reduced by fifty (50) percent, at the direction of the Engineer. in order that a more closely controlled failure curve may be plotted. The full test load shall remain on the test pile not less than forty-eight (48) hours. The full test load shall then be removed and the permanent settlement read.

When directed by the Engineer load tests shall then be continued beyond the double design load in 10-ton increments to failure or a maximum of three (3) times the design load.

The pile may be considered to have failed when the total permanent settlement exceeds (6) mm.

18.1.4.8 Pile Record

The Contractor shall keep records of the piles driven or installed. A copy of the record shall be given to the Engineer within two (2) days after each pile is driven. The record form to be used shall be approved by the Engineer. The pile records shall give full information on the following: -

Driven Piles	Cast-in- place Piles
Pile Type and dimension	Pile type and nominal dimensions.
Driving equipment, type, weight, reach-and efficiency of hammer etc.	Date of boring commenced, level reached each day and date of casting.
Date of casting (for concrete piles) and driving.	Soil samples taken from pile boring operation and soil test results.
Details of Reinforcement.	Strata and ground water encountered with levels. description shall be in accordance with 8.S.C.P. 2001.
Test results on concrete	Length of finished pile and tip elevation

Depth driven & tip elevation.	Dia of borehole.
For gravity and single-acting hammers: the height of drop.	Elevation of the bottom of borehole.
For double acting hammers: the frequency of blows.	Date of placing concrete; theoretical and actual quantities of concrete used in pile.
Final set for last 20 blows for every 10 piles and when the Engineer so requires the penetration along the whole driven depth shall be recorded.	Lengths and diameter of temporary casing and permanent lining and the elevation of the tip of temporary casing and of permanent lining.
Details of any interruption in driving.	Details of Reinforcement.
Level of pole top immediately after driving, and the level when all piles in the group are driven.	Details of penetration during boring operation or driving of steel shell (driving records as for driven piles).
Details of re-driving.	Quality, consistency and other test results on concrete
Any other relevant information.	Time interval between boring or driving and concreting.
	Any other relevant information.

18.1.4.9 Confirmatory Boring

The contractor shall carry out confirmatory boring at site at locations indicated by the Engineer. Boring shall be carried out with ASTM D 1586 Penetration Test and Split barrel sampling of soil. Additionally, when undisturbed sampling is required. the procedure shall conform to ASTM D 1587. Thin Walled sampling of soil. Diameter of boreholes shall be twenty (20) centimeters cased throughout its length and shall be down to the designated elevation. In-situ standard penetration test shall be carried out at one and half (1.5) meters interval from designated top elevation to the bottom of the hole. Undisturbed samples shall be taken from substratum. If day is encountered, undisturbed samples will be taken at interval of three (3) meters. At least two borings are required at each bridge site. The boring shall extend to a depth of at least three (3) meters below the pile tip elevation as indicated in the drawings.

18.1.5 Measurement and Payment

18.1.5.1 Measurement

The quantities to be paid for shall be the number of linear meters of piles, completed and accepted, measured from the pile tip elevation to the bottom of pile caps, footings or bottom of concrete superstructure in the case of pile bents. In case the bottom of pile caps or footing or bottom of pile bent is above N.S.L and method of fabrication is such that the work above N.S.L is done as that of column, the same shall be measured as concrete and steel for column. No allowance shall be made for cut-offs or the required length of concrete or reinforcement steel placed into the concrete structure as called for on the drawings. My additional pile lengths that may be necessary to suit the Contractors method of operation or for any other reason shall not be included in the measurements. For cast-in-situ piles, helical and vertical steel will be measured in Tons. Pile casing where ever provided will be measured in linear meters. Measurement shall be made for permanently placed pile casing s shown on drawings. If the Contractor likes to use temporary casing for the convenience of preparing of boreholes, the same shall not be measured

whether left at site or withdrawn after completing the boreholes. Test piles when ordered by the Engineer, whether or not utilized as service piles in the structure shall not be included in the above measurements. Accepted test piles will be measured separately as the number of linear meters.

- Pile shoes when called for on the Drawings or by the Engineer shall be measured by the number accepted in place.
- Splicing of piles if not shown on the drawings will not be allowed except that the length of reinforcement is to exceed 12 meter in which case the splicing will not be measured or paid directly but the cost thereof shall be considered as included in the unit price for piling.
- Load tests shall be counted as the number of complete and accepted load tests as described in 18.1.4.7.
- Concrete footings or pile caps shall be measured and paid for as provided under "Structures". Additional quantities of concrete, reinforcement and formwork caused by incorrect location of piles or additional piles necessary to replace defective piles shall be to the Contractor's expense.

18.1.5.2 Payment

- The quantities of piling left in place in the accepted structure measured as provided above shall be paid for at the contract unit price per linear meter of piles of the different types listed below and shown in the Bill of Quantities.
- For cast-in-situ piles, rate per linear meter will include all items except for helical and vertical reinforcement, which will be paid as per steel reinforcement.
- For pre-cast piles, the cost of steel shall be included in the rate per linear meter.

Pile casing will be paid at the contract unit price per linear meter for pile casing. Test piles whether or not used in the completed structure or constructed adjacent to structure as per requirements of the contract document shall be paid for at the contract unit price for pile installation. Load tests shall be paid for at the contract unit price for pile load Tests, either one and half (1.5) times or two (2) times the design load. The unit price for test loading to three (3) times the design load shall include the total load test with all load increments. Payment for tubular steel piles left in place shall include the cost of the concrete core of the specified class of concrete and the steel reinforcement of the said concrete core. The quantity to be paid for confirmatory boring shall be the number of linear meters of the boring completed and accepted. Such prices and payment shall be considered full compensation for furnishing all materials, performing standard penetration and all other relevant laboratory tests, labour, equipment, tools, fuel, welding, if needed and other incidental expenses including splicing, caging providing covers etc. necessary to complete the item as directed by the Engineer.

Pay item No.	Description	Unit of Measurement
18.1.5.2.1	Untreated Timber Piles	M
18.1.5.2.2	Treated Timber Piles	M
18.1.5.2.3	Precast Concrete piles type	M
18.1.5.2.4	Cast-in-place concrete Piles, type	M
18.1.5.2.5	Structural Steel Piles, type_	M
18.1.5.2.6	Pile Shoes Type	Each

18.1.5.2.7	Test Piles Type	M
18.1.5.2.8	Pile Load Tests to 1.5 times the design load	Each
18.1.5.2.9	Pile load tests to 2 times the design load	Each
18.1.5.2.10	Pile load tests to 3 times the design load	Each
18.1.5.2.11	Confirmatory boring	M
18.1.5.2.12	Permanent pile Casing, type	M
18.1.5.2.13	Temporary pile Casing, type	M

18.2 Concrete Load Bearing Piles

18.2.1 Specifications

18.2.1.1 General

- a. All concrete materials and their production, formation, placing, curing and repair under these Specifications shall confirm to the Specifications for Cement Concrete.
- b. All fine and coarse aggregate used for concrete under these Specifications shall confirm to the Specifications for fine and coarse aggregate respectively.

18.2.1.2 Manufacture

All concrete load bearing piles shall be manufactured in accordance with the details shown on the drawings or as directed by the Engineer-in-charge in writing. Piles shall be cast on level; the tight platforms shall be constructed to prevent settlement during the casting and curing operations. All concrete shall be thoroughly compacted by adequate vibration, spading and rodding during the placing operation, and shall be thoroughly worked around the reinforcement and into the corners of the forms. Vibrations shall be applied uniformly over the entire length of the pile and shall be of sufficient duration to ensure a thorough compaction. Pick-up points and date of casting shall be distinctly marked on each pile.

18.2.1.3 Dimensions of Piles

Unless otherwise specified or directed by Engineer-in-charge in writing, the dimensions of the piles shall be as shown on the approved drawings.

18.2.1.4 Placing

Piles shall be driven as accurately as practicable in the correct location, true to line both laterally and longitudinally and to the vertical line as indicated on the drawing. A lateral deviation from the correct location at the cut-off elevation of not more than 3 inches shall be permitted. A variation in slope of not more than 2 inches per 10 feet of longitudinal axis shall only be permitted. The correct relative position of piles shall be maintained by the use of template or by other approved means. Any pile driven out of correct locations shall be pulled out and re-driven by the contractor at no additional cost. No lateral force of any nature or magnitude shall be permitted to pull a pile into correct position or vertical alignment.

18.2.1.5 Driving

Piles shall be driven by means of a steam hammer or an air hammer of a size and type suitable for the work, as approved by the Engineer-in-charge. The weight of the moving parts of the hammer shall not be less than 8000 pounds, unless otherwise authorized by the Engineer-in-charge. The hammer shall be operated at all times at the steam or air pressure and at the speed recommended by the manufacturer. Boiler or compressor capacity shall be sufficient to operate the hammer continuously at full rated speed. During driving, piles shall be protected by a cushion and cap approved by the Engineer-in-charge. Pile drivers shall have firmly supported leads

extending to the lowest point the hammer must reach to drive the piles to cut-off elevation without the use of a follower. Each pile shall be driven continuously and without voluntary interruption till the required depth of penetration has been attained. Deviation from this procedure shall be permitted by the Engineer-in-charge only in case the driving is stopped by causes which could not reasonable have been anticipated. Water jet shall be allowed to be used to assist driving only when specifically authorized by the Engineer-in-charge, who shall grant such permission only where satisfactory driving cannot be obtained otherwise. Where jetting is authorized, the jetting equipment shall be of a type and capacity approved by the Engineer-in-charge. The lowest 3 feet shall, however, be always driven without jetting. Unless otherwise authorized. by the Engineer-in-charge, no pile shall be driven within 100 feet of concrete less than seven days old. Unless otherwise specified or directed by the Engineer-in-charge all pile tops shall be driven to cut-off elevation.

18.2.1.6 Damaged and Misplaced Files

Any pile which is cracked or broken because of internal defects or by improper handling or driving, or which is otherwise injured so as to impair it for its intended use or any pile driven out of proper location, shall be removed and replaced by the contractor it his own expense. The Engineer-in-charge may require the contractor to pull out certain selected piles (up to a maximum of 2% of the total number of the piles driven subject to a minimum or 2 piles) for test and inspection to determine their condition. Any pile so pulled out and found to be damaged to such an extent as, in the opinion of the Engineer-in-charge, would impair its usefulness in the completed structure, shall be remove from the site of the work, and the contractor shall furnish and drive a new pile to replace the damaged one. Piles pulled out and found to be in a sound and satisfactory condition shall be re-driven and in such a case payment for initial driving, pulling out and re-driving shall be made to the contractor.

18.2.1.7 Cut-Off

A pile which cannot be driven to the required depth of penetration because of an underground obstruction shall be pulled out, the obstruction removed, and, the pile re-drive, all at the contractor's expense. If for any reasons it is not possible to drive a pile to the required depth of penetration, the Engineer-in-charge shall determine, whether an acceptable friction bearing capacity has been attained, and, if so, shall permit the contractor to cut the pile off perpendicular to the axis of the pile at the cut-off elevation. Otherwise, the contractor shall continue to drive the pile or pull out and re-drive the pile in order to obtain the required depth of penetration. The cut-off method shall be used in a way that does not damage the portion of the pile to be left in place nor the pile reinforcement.

18.2.1.8 Splicing

- Piles should be lengthened, when so required, by splicing, after getting approval of the Engineer-in-charge. For this purpose, the longitudinal reinforcement of the pile Shall be exposed for a length equal to at least 50-diameters of the bars. If necessary, the concrete shall be cut away to accomplish this. Bars of the same size and of a length sufficient for the required extension shall be fastened to the exposed bars and transverse reinforcement for the pile head; concrete cuts shall be made perpendicular to the axis of the pile; and all

concrete shall be removed above the elevation of the 50-diameter length cut. Bars shall be lapped for the full length of the bars exposed. Alternatively, the splicing can be done by welding the reinforcement bars, if approved by the Engineer-in-charge. In such cases only enough concrete shall be removed to provide adequate working space for the welding operation.

- When reinforcement has been properly placed, by lapping or welding, the top of the pile shall be roughened and the necessary formwork placed. Immediately before pouring concrete, the top of the concrete shall be thoroughly wetted and covered with a thin coat of neat cement mortar. Concrete of the same quality as that used to cast the pile shall then be placed, finished and cured as specified for all piles, except that forms shall remain in place for at least 72 hours after placing the concrete. Driving of a spliced pile shall not be resumed till it is approved by the Engineer-in-charge.

18.2.1.9 Storage and Handling

Storage and handling of the piles shall be executed in a way that does not subject them to over-stress, spalling or other injuries. Piles shall remain undisturbed after casting and shall not be subjected to handling till the specified curing period ends. They shall be lifted by means of a suitable bridle or slings attached to them at the marked pick-up points. Piles which are over-stressed or otherwise injured during curing or handling shall be removed away from the site or work by the contractor at his own expense.

18.2.1.10 Measurement

The length of the piles driven and installed below the cut-off elevation in accordance with the approved drawings and specifications or as directed by the Engineer-in-charge in writing shall be reckoned for the purpose of making payment. The unit of measurement shall be linear foot measured along the axis of the pile.

18.2.1.11 Rate

- a. The rate unit shall include the manufacture, storage, handling, transportation and driving of the concrete piles conforming to above specifications of the works as under.
 - i) At the site of work (to be defined in the conditions of contract).
 - ii) Pulling out, removal and replacement of the damaged piles discovered during the process of testing as stated in these specifications.
 - iii) Culling off any pile which the contractor is unable to drive to the required depth of penetration or pulling it out and re-driving it in order to obtain the required depth of penetration in accordance with the provisions of these specifications.
 - iv) Splicing that may be required under the provisions of these specifications.
- b. The following item shall be paid in addition to the unit per linear foot:
 - i) Piles driven of the cut-off elevations, which are pulled out at the direction of the Engineer-in-charge under the provisions of these specifications and found to be in good conditions, shall be paid for at the unit rate per linear foot for pulling out and at 50% of the unit per linear foot for re-driving.

18.3 Sheet Piling

18.3.1 Description

This item shall consist of furnishing, driving, cutting off and removal, if required, of sheet piles in accordance with the Drawings, or as designated by the Engineer. Sheet piles for cofferdams in connection with foundations for structures shall be included in the unit price for Structural Excavation. Sheet piling shall be a separate pay item only when stated in the Bill of Quantities.

18.3.2 Material Requirement

18.3.2.1 Timber Sheet piles

The timber, unless otherwise definitely noted on the Drawings or in the Special Provisions, may consist of any species, which will satisfactorily stand driving. It shall be sawn or hewn with square corners or with tongue-and-groove joint as directed by the Engineer and shall be free from holes, loose knots, wing shakes, decay or unsound portions, or other defects which might impair its strength or tightness.

18.3.2.2 Concrete sheet piles

Concrete, reinforcement, and manufacture of Concrete Sheet Piles shall conform to the Specifications governing Precast Concrete Piles under - Piling. Joint details shall be as indicated on the Drawings.

18.3.2.3 Steel Sheet Piles

Steel Sheet piles shall be of the type and weight indicated on the Drawings. The steel shall conform to AASHTO M 223 or ASTM A 572. Permanent steel sheet piles shall be coated with red lead paint conforming to AASHTO M 72 as instructed by the Engineer.

18.3.2.4 Bracing

Bracings or anchors for sheet piles shall be made of wood or steel according to the Drawings or as designated by the Engineer. For temporary sheet piling like cofferdams for excavations, the Contractor shall be solely responsible for the design and construction of the bracing. The Drawings shall have the approval of the Engineer, but such approval does not in any way relieve the Contractor of his responsibility.

18.3.3 Construction Requirement

1. Handling of Piles

All piles shall be lifted by means of suitable bridle or sling attached to pile at marked pick up points to avoid damage to piles. They shall be properly loaded and carted to the specified place and unloaded in workman like manner and sorted at specified place(s) for further use. Piles which may have been injured during handling, loading or unloading or carriage by the contractor will be rejected and replaced by the contractor at no cost to the employer.

2. Installation

Timber and concrete sheet piles shall be sharpened at their lowest ends. All sheet piles shall be driven to the elevation shown on the Drawings or as directed by the Engineer. Where it is impossible to drive to the elevation shown on the Drawings due to sub-surface conditions, the piles may be stopped at a higher elevation with the written permission of the Engineer. However, before granting such permission the Engineer shall investigate to ascertain that the Contractor has adequate equipment for the required driving and that the piles cannot be driven to the elevation shown with the proper use of this equipment. The tops of a permanent sheet piling shall be driven or cut-off to a straight line at the elevation indicated on the Drawings.

The requirements governing the installation of sheet piling shall conform to those governing piles as set forth under 18.1.4.3 and 18.1.4.8

3. Removal

Temporary sheet piling shall be removed or cut off at the stream bed or the original ground when directed by the Engineer. In case when the Engineer orders sheet piling to be left in place for erosion protection, the Contractor and the Engineer shall agree on an equitable price.

18.3.3.1 Concrete Sheet Piles

18.3.3.1.1 Specifications

18.3.3.1.2 Placing

Unless otherwise specified or directed by the Engineer-in-charge in writing, concrete sheet piles shall be carefully located as shown on the approved drawings in a plumb position each pile interlocked with adjoining piles for their full length so as to form a continuous diaphragm throughout the length of each run of sheet pile wall. All sheet piles shall be driven as true to the line as practicable by providing suitable temporary walls or guide structure to depths shown on the approved drawing and shall extend to the elevation.

indicated for the top of piles. In case of structure where water tightness is certified to be necessary by the Engineer-in-charge the following procedure shall be adopted.

18.3.3.1.3 Watertight Joints

After driving sheet piles to the specified depth, the joints between them shall be flushed out by a water jet from a pipe long enough to reach the bottom of the piling. The groove shall then be filled with cement grout composed of one part of cement to two parts of sand to ensure a watertight joint.

18.3.3.1.4 Intersection of Existing Pile Lines by New Piling

When new piling intersects existing pipe line, a sufficient quantity of the existing piling shall be extracted to permit the new piling to be installed without a break in continuity or water tightness.

Extraction or the existing piling shall be limited to that required for a workmanlike installation of new piling and shall be duly approved by the Engineer-in-charge.

18.3.3.1.5 Other Respects

In all other respects, concrete sheet piling shall conform to the relevant clauses of the Specifications for Concrete Load Bearing Piles mentioned above.

18.3.3.2 Mild Steel Sheet Piles

18.3.3.2.1 Specifications

18.3.3.2.2 Type

Unless otherwise specified or directed, the type and pattern of mild steel sheet piles shall be, as shown on the approved drawings.

18.3.3.2.3 Tolerance

The minus tolerance on the pile thickness shall not exceed 2½ percent.

18.3.3.2.4 Treatment Prior to Driving

When considered necessary by the Engineer-in-charge, each pile, before driving, shall receive two coats of non-setting cold applied bituminous material of a consistency that does not run or flow and yet can be easily applied into the interlock. Unless otherwise specified or directed in writing by the Engineer-in-charge, the material for these coatings shall be the same as specified in the approved drawings of the sheet piles.

18.3.3.2.5 Dizzying

Unless otherwise specified or directed in writing by the Engineer-in-charge the lay-out of the sheet piled cut-offs shall be as given on the approved drawings. The piles shall be normally driven in pairs with their clutches engaged from their full length and any indication that pile has become bent or a clutch has become disengaged shall require the immediate withdrawal of that pile. The piles shall be given vertically to the alignment shown on the approved drawings to true lines and even planes and to the levels indicated. Deviations shall not be greater than 3 inches from this alignment and one degree from the vertical plane, but the junction piles shall be located within one inch. The junction piles shall be provided at all pints shown on the approved drawings or where rows of piles meet and shall be of the same length as the longer of the rows joined. If there is any defect in the horizontal or vertical alignment of the piling or a break has actually occurred in the continuity of the piling or is suspected to have occurred such a pile or piles, whether defective or not, shall be withdrawn and new piles driven to remedy the defect or suspected defect. If any distortions, creep or fanning occur in the line of piling, steps shall be taken to rectify the defects and where necessary suitably tapered piles shall be driven to the satisfaction of the Engineer-in-charge or his authorized representative. Driving by jetting shall be done only if

approved by the Engineer-in-charge. Care shall be taken to ensure that the jetting does not loosen the soil below the feet of the piles and for the last 3 feet the pile shall be driven without jetting.

18.3.3.2.6 Dimension of Sheet Piles

Unless otherwise specified or directed in writing by the Engineer-in-charge, the sheet piles shall be of the dimensions indicated on the approved drawings.

18.3.3.2.7 Measurements

The mild steel pile shall be measured by weight. The unit of measurement shall be one ton.

18.3.3.2.8 Rate

The unit rate shall include furnishing sheet piles of an approved make and specified length, stacking and driving them as per above Specifications at site of work to be defined in the conditions of contract. No payment shall be made for carrying out remedial measures necessary for driving the sheet piles to the correct depth and in the correct alignment as per above Specifications.

Where the sheet piles are supplied by the Government, the unit rate shall include driving the sheet as per above Specifications at site of work to be defined in the conditions of contract.

18.3.3.3 Timber Sheet Piles

1. Specifications

Timber sheet piles shall be used in temporary structures for shorter spans and braced sheeting in excavation works. Preservative treatment shall be given if it is to be used in permanent structures above water table. It resists light lateral loads. These piles shall mainly connect by tongue and groove joints. Transmission of loads shall take place by frictional resistance of ground and pile surface. Timber used in these piles should from tree like Sal, Teak, Deodar, Babul and Kail etc.

2. Placing

Pile driving machine shall be used to drive these piles in which drop hammer deliver blows on the pile head. Iron ring at the pile top of diameter less than 25mm should be used to prevent brooming of pile head. The lower end should be pointed and provided with a cast iron conical shoe to facilitate driving.

3. Spacing

Piles should not be spaced less than 60 cm c/c as closer spacing destroys frictional resistance.

4. Load

Maximum Load should not exceed 20 tonnes.

5. Length

Length should not be more than twenty times the least sectional dimension.

2. Disadvantage

- These Piles are not suitable in Strata consisting of Gravels and Boulders.
- Life of timber sheet pile is short even after the application of preservative treatment.

18.3.4 Measurement and Payment

18.3.4.1 Measurement

When stated as a separate pay item in the Bill of Quantities, sheet piling will be measured by the square meters of sheet piling or as a Lump Sum as shown on the Drawings or directed in writing by the Engineer, complete in place and accepted. Measurement of piling, which has been delivered according to Drawings and cannot be driven to the directed elevation because of subsurface conditions shall be measured to the driven elevation.

18.3.4.2 Payment

Payment of timber Sheet Piles, Concrete Sheet Piles and Steel Sheet Piles as determined under measurement shall be made at the contract unit price per square meter or as a Lump Sum for the pay items listed below and shown in the Bill of Quantities. Such prices and payment shall be considered full compensation for all materials, labour, equipment, tools paint, bolts, Wales and incidentals necessary to complete the Item. All necessary bracings, whether shown on the drawings or not, shall be included in the contract price. The under mentioned pay items and prices shall not apply to the equitable rate for sheet piling left in place for erosion protection according to requirements of sheet piling.

Pay item No.	Description	Unit of Measurement
18.3.4.2.1	Timber Sheet Piles	SM
18.3.4.2.2	Concrete Sheet Piles	SM
18.3.4.2.3	Steel Sheet Piles	SM

18.4 Well Foundation

18.4.1 Description

This item shall consist of performing all operations in connection with the construction of a well to be used as a foundation for a pier or abutment. The work shall be comprised of five separate main operations: -

- The casting of well kerb in proper position.
- The erection of well steening by stages
- The sinking of the erected kerb and well steening to the required elevation
- The proper plugging of the well.
- The construction of the transom slab all in accordance with specifications and the Drawings or as directed by the Engineer.

18.4.2 Material Requirements

1. Structural Steel

Structural steel shall conform to the requirements of AASHTO M 183 (ASTM Designation: A 36 unless otherwise specified).

2. Reinforcing Steel

Reinforcing steel shall conform to the requirements under Steel Reinforcement.

3. Structural Concrete

Structural concrete shall conform to Class A concrete requirements as specified in Concrete.

4. Brickwork

Brick work shall conform to the requirements as specified in Brick Masonry of these specifications.

5. Fill Sand

Fill sand shall consist of natural sand free from deleterious materials subject to the approval of the Engineer and as specified and shown on the Drawings.

18.4.3 Construction Requirement

18.4.3.1 Construction Equipment

All equipment to be used in construction shall be on the Site in first class working condition and shall have been approved by the Engineer before construction is started. The number of units, the sizes, etc., of all equipment shall be adequate to ensure completion of the work within the time specified in the Contract. No equipment shall be removed from the Site without the written

approval of the Engineer. All equipment, tools and machinery used shall be maintained in a satisfactory working condition throughout the required period of their use.

18.4.3.2 Structural Steel Works

1. Notice of Rolling and Fabrication

The contractor shall give ample advance notice to the Engineer of the beginning of the work at the mill and shop, so that inspection may be provided. No material shall be rolled or fabricated before the Engineer has been notified where the orders have been placed.

2. Facilities for Inspection

The Contractor shall furnish all facilities for the Inspection of materials and workmanship in the mill and shop, and inspector shall be allowed free access to the necessary parts of the premises.

3. Inspection of fabricated work at site

The Engineer may waive shop Inspection and make complete inspection of all fabricated work upon its delivery at the Site of structure. All structural steel works shall conform to the applicable ASTM requirements of Steel Structure, In case these requirements are not met, the material thus fabricated shall be rejected.

4. Handling Members

The field assembling of the component parts of the structure shall be done by the use of twisting, bending or otherwise deforming the metal. No members slightly bent or twisted shall be put in place until their defects are corrected and any members seriously damaged in handling will be rejected.

5. Finish of Structural Steel Works

The workmanship and finish shall be first class and equal to the best practice in modern bridge shops. Shearing and clipping shall be done neatly and accurately and all portion of the work exposed to view shall be neatly finished.

18.4.3.3 Special Construction Operations

1. Casting Well Krebs

The cutting edge of the well kerb will be structural steel pre-fabricated and supplied in segments convenient for Site assembly by bolting together as per lines and dimensions shown on the Drawings. The segments of the cutting edge shall be interchangeable. The fitting together shall be checked at the site of fabrication work by the assembly of at least two complete cutting edges, formed of segments chosen at random before these are accepted for dispatch to the site of work. None of the steel work is to be painted and no surface preparation is called for other than the removal of the rust and loose adhering mill scale. Reinforcing steel work in the cutting edge will

be properly bolted to the steel work and placed and assembled as shown on the Drawings. Structural concrete for the cutting edge will be of the required strength and shall be finished to the form and dimensions shown on the Drawings.

2. Well Steening

Well steening shall be made either of brick work in (1:3) cement mortar or Portland cement concrete of the required strength and of the form and dimensions as shown on the Drawings. Reinforcing steel work will continue from the cutting edge into the well steening with spacers made of structural steel work consisting of mild steel plates of the size and dimension as shown on the Drawings.

3. Well Sinking

Well sinking includes all operations required to sink the well in position and to the required elevation.

i. Positioning

Each well kerb shall be correctly positioned in place and approved by the Engineer before commencement of further work.

ii. Support

Well kerb shall be adequately supported to prevent shift or tilt during the initial operation and on excavation and sinking whether the well has been started on made up ground or in water in excavation.

iii. Excavation of Sinking

The soil from inside the well shall be removed by mechanical grabbing or by other devices as approved by the Engineer. The accuracy of the sinking will be the responsibility of the Contractor.

iv. Dewatering

The Contractor will be required to pump out the water from inside the wells in such a way as shall be approved by the Engineer; but notwithstanding any dewatering aid that the Contractor may use to assist in the operation of sinking the wells, the safety of plant and labour will remain the responsibility of the Contractor.

v. Limits of Tilt and Shift

The limit of departure from true vertical position of any well shall not exceed one unit measured horizontally in a vertical distance of sixty units. The maximum horizontal displacement of any well away from its correct position shall not exceed twenty (20) cm.

vi. Correcting Tilt etc

It will be entirely the responsibility of the Contractor to keep the tilt and shift within the specified tolerances. If the above limits are exceeded, the Contractor will be required to adopt measures to overcome the adverse effects of such shifts and tilts. In any case maximum pressure at the base of foundations after accounting for all shifts and tilts shall remain within the specified limits. The measures taken shall be allowed only after its approval has been received from the Engineer.

vii. Kentledge

The use of rails and other heavy weights is permissible in well sinking and in correcting error of tilt and horizontal displacement. But the Contractor must take care not to damage the well in the process: and in any case he must obtain the approval of the Engineer for his proposed method.

viii. Limits of well sinking

Each and every well shall be sunk to the level indicated on the Drawings. But in no case shall the Contractor stop well sinking unless he has first obtained the approval of the Engineer.

4. Plugging of well

When the well has reached the final elevation to which it is to sink and has been approved by the Engineer, the bottom of the well will be plugged by the depositing concrete of the required strength.

- Concrete Under Water: The concrete deposited under water shall have ten (10) percent excess cement. To prevent segregation, it shall be carefully placed in the final position by means of a dump bucket or other approved method and shall not be disturbed after being deposited. The concrete shall be placed under the supervision of the Engineer.
- Continuous Placing: The concrete shall be placed in one continuous operation.

5. Sand Filling

When the well bottom has been plugged, the well hole will be filled with sand as specified and shown on Drawings. The sand shall be free from deleterious materials.

6. Transom Slab

When the well bottom has been plugged, the well top will be provided with a transom slab made of structural concrete of required strength, and reinforcing steel work, all according to the lines, dimensions and form shown on the Drawings.

18.4.3.4 Sampling and Testing

The Contractor will have adequate arrangements to the satisfaction of the Engineer to collect disturbed samples of soil at every one and half (1.5) meter elevation and at every change of soil stratum and to deliver it in proper bags to the representative of the Engineer. The Contractor will also be required to obtain three samples of the natural soil at the elevation at which the well kerb

has been stopped and another sample three (3) meters below that elevation before he is allowed to plug the well.

18.4.4 Measurement and Payment

18.4.4.1 Measurement

1. General

For the various items of work constructed under this Item, measurement shall be made as narrated under the respective items. The quantity to be paid for shall be the original plan quantity measured as provided for respective items, except where changes have been made by the Engineer and order has been given in writing.

No measurements for or other allowances will be made for work or materials for forms, false works, supports, bracings, kentledge or pumping.

2. Structural Steel

The quantity of structural steel entering into and becoming a part of the completed structure, and accepted by the Engineer shall be the computed weight in metric tons of this material entering into the completed structure of item of work.

The unit of measurement of structural steel work shall be metric tons.

The weights of the rolled shapes, bare plates and pipe railing shall be computed on the basis of nominal weight as given in the manufacturer's hand books, using the dimensions shown on the drawings. The weight shall be computed on the basis of dimensions and ordered overall lengths for all structural shapes. No deductions from the computed weight of rolled steel shall be made for caps, clips, sheared edges, punching borings, drillings, milling or planning and no allowance shall be made for the weight of weld metal or for over run in weight.

3. Reinforcing Steel

For well kerb, steening and transom slab reinforcing steel shall be measured and paid for according to the requirements of Steel reinforcement.

4. Structural Concrete

For well kerb steening, plugging of well and transom slab construction, concrete shall be measured and paid for according to the requirements of concrete. The unit rate includes the cost of ten (10) percent extra cement to be used where required.

5. Brick Work

In (1:3) cement mortar for steening shall be measured and paid for according to the requirements of Brick masonry.

6. Well Sinking

For any item of work carried out under this head, measurement shall be made per linear meter of twin or single well of specified external diameter, sunk below the bed level shown on the Drawings. The unit of measurement shall be one linear meter. The unit rate for sinking twin or single well shall include excavation, pumping, supports, bracings, kentledge, tilt correction soil samples all according to the requirement.

7. Fill Sand

The well hole shall be measured as the volume of well hole required to be filled. The unit of measurements shall be in cubic meters.

18.4.4.2 Payment

Payment will be made in accordance with the unit price in the Bill of Quantities for the various items in accordance with the. Specifications and shall constitute full compensation for furnishing all material, equipment, labour and for performing all operations necessary to complete the work. Provision delivery of materials to site, handling and storage and all incidentals shall be include in unit prices for various items.

Pay Item No.	Description	Unit of Measurement
18.4.4.2.1	Structural Steel	Ton
18.4.4.2.2	Reinforcing Steel	Ton
18.4.4.2.3	Structural Concrete	CM
18.4.4.2.4	Brickwork	CM
18.4.4.2.5	Well Sinking	CM
18.4.4.2.6	Fill Sand	CM

Table of Contents

19	PROTECTION AND DIVERSION WORKS	2
19.1	Scope	2
19.2	Construction Materials	2
19.2.1	Pilchi, Farash or Sarkanda	2
19.2.2	Pitching Stone	2
19.2.3	Gabions	2
19.3	Construction Requirements	3
19.3.1	Pilchi Pitching/Revetment	3
19.3.2	Stone Pitching	3
19.3.3	Gabion Wall	4
19.3.4	Wire Crates & Mattresses (Gabions)	4
19.3.5	Spur and Groyne	7
19.3.6	Construction Program	9
19.4	Measurement and Payment	9
19.4.1	Measurement	9
19.4.2	Payment	10

PROTECTION AND DIVERSION WORKS

19.1 Scope

This chapter shall comprise the specifications for the construction of river protection and diversion works including guide bunds and river diversion works comprising of earthen embankments protected by a stone aprons, stone pitching on the slope and pilchi -pitching etc., all in accordance with these specifications and in conformity with the lines, levels, thickness and typical cross sections shown on the drawings or as directed by the Engineer.

19.2 Construction Materials

19.2.1 Pilchi, Farash or Sarkanda

19.2.1.1 Quality

The pilchi, farash or sarkanda used for pitching shall be of the best quality locally available and duly approved by the Engineer.

It shall be used when it is still green.

19.2.1.2 Dimensions

Unless otherwise specified or directed, pilchi rolls as headers shall be 5 feet (1.5 m) long and 6 inches (150 mm) in diameter and those used as stretchers 30 feet (10 m) long and 6 inches (150 mm) in diameter.

The rolls shall be well-compacted and tightly tied with coarse munjban or binding wire at one foot (300 mm) interval.

19.2.2 Pitching Stone

The pitching stone shall be angular limestone or other approved rock having a specific gravity of not less than 2.6. It shall be hard, dense and durable. For the hand packed courses in the river side slope and noses of the guide bank, no individual stone shall weigh less than 90 lbs or more than 150 lbs and the minimum dimension of any stone shall be 6 inches (150 mm). Rounded stone shall not be accepted.

19.2.3 Gabions

Unless otherwise specified by the Engineer in Charge, the wire for making a gabion basket shall be min. of guage-8. The stone to be used in the gabions should also atleast satisfy the specifications mentioned in para 19.2.2 above.

19.3 Construction Requirements

19.3.1 Pilchi Pitching/Revetment

- a. The inner side of the embankment shall be cut out to accommodate the pitching or pitching shall be done on the surface of the existing bank strictly as specified or directed in writing by the Engineer.
- b. Unless otherwise specified or directed, the pitching shall be started from the ground level.
- c. The first or the lowest layer of rolls shall be laid as headers and as close to each other as possible in order to get one compact layer of pilchi,
- d. The second layer shall consist of stretcher rolls tied down by means of three-foot long pegs at five-foot interval. The stretcher roll shall be so located that it lies just within the inner slope of the embankment.
- e. After laying header and stretcher rolls a layer of good earth shall be placed and thoroughly compacted to make it level with the top of stretcher roll.
- f. The second and subsequent layers of header and stretcher rolls shall then be laid as previously and then process repeated till the pitching has been carried to the specified level.

19.3.2 Stone Pitching

- a. Apron pit shall be excavated, levelled and dressed all according to the lines and levels, shown on the Plan.
- b. The stone pitching in the apron pit shall be laid roughly packed. At intervals of about 200 feet (60 m) measured along the guide bank, the stone pitching in the apron shall be completed to its full height over widths of 5 feet (1.5 m) extending across the full breadth of the apron.
- c. The levels of the tops of the stone in these preliminary works shall be checked and approved by the Engineer before the rest of the pitching stone is built up to the full depth and full breadth of the aprons.
- d. The coursing of the stone on the armoured slopes and noses of the guide banks shall be according to the lines, dimensions and requirements shown on the Plans.
- e. The base course shall consist of 6 inches (150 mm) thick quarry spawls, free from dust and fine stone.
- f. The final course shall be 15 inches (375 mm) thick of hand packed stone, each stone placed and wedged in position with spawls to give an even surface, free from holes and pockets and with no individual stone protruding from its neighbours by more than one inch (25 mm).

- g. The laying of stone pitching on the armoured slope is to proceed after the completion of the stone aprons.

19.3.3 Gabion Wall

Gabion wall is provided in the event that wall has to maintain more than 3 m height. Gabion boxes are made from gabion wire under which the dry stones are placed. Some considerations are required to be made as mentioned below;

- a. The slope of the gabion wall shall be maintained at 1:4 and the foundation at 4:1 slope. Joint of the gabion shall be properly secured by a gabion wire.
- b. Separation shall be maintained between the two horizontal Gabion boxes. When the boxes are filled with dry stones, these shall be closed by gabion cover. Tie wire shall be provided at the middle of the gabion boxes, which acts as bond stone as in the case of dry stone. The upper surface of the boxes shall be covered with 30-50 cm earth.

19.3.4 Wire Crates & Mattresses (Gabions)

Wire crates or Mattresses are generally used for shallow depths or in accessible situations. These wire crates or mattresses are also known as gabions.

- a. Maximum Size of the Wire crate can be about (3 m x 1.5 m x 1.2 m) or as specified on the drawings.
- b. For deep and inaccessible situations, wire crates must be made smaller according to the situation.
- c. Where there is a chance of overturning, the crates shall be divided into compartments.
- d. Wire mattresses built in-situ shall not be larger than 25' x 10' x 2' (7.6 m x 3.0 m x 0.61 m) and smaller than 6' x 3' x 1' (1.83 m x 0.91 m x 0.30 m), but actual size should be according the drawings or as directed by the Engineer in-Charge.
- e. Sides of large mattresses shall be securely stayed with the help of fasteners/binders at intervals of not more than 5 ft (1.5 m) to prevent bulging.
- f. The size of the netting will depend upon the size of the boulders available. The boulders shall be of larger size than the mesh size.

19.3.4.1 Wire Mesh for Gabions

Gabions shall consist of rectangular wire mesh formed containers filled with stones/boulders. Gabions will conform to one of the following mesh types:

Woven Mesh - Non-raveling double twisted hexagonal wire mesh, consisting of two wires twisted together in two 180 degree turns. The cage or tangering shall ordinarily

made of galvanized steel wire woven with maximum size of (6" x 4") hexagonal mesh, depending upon the size of the stones/boulders available to construct the Gabions. For smaller size boulders available, the size of the openings in the mesh can be reduced and shall be according to the dimensions as given in the drawings or as directed by the Engineer in-Charge.

Welded Mesh – Welded wire mesh with a uniform square or rectangular pattern and a resistance weld at each intersection. The welded wire connections shall conform with the requirements of ASTM A1064 / A1064M, including wire smaller than W1.2 (0.124 in.); except that the welded connections shall have a minimum average shear strength of 70% and a minimum shear strength of 60% of the minimum ultimate tensile strength of the wire.

19.3.4.2 *Wire for Gabions*

Steel Wire for fabrication and assembly conforming to ASTM A641 / A641M shall be hot-dipped galvanized. The wire shall have a minimum tensile strength of **60,000 psi** or as per ASTM standard mentioned above. The thickness of the galvanization of the steel wire shall conform to the ASTM A123 / A123M. The steel wire to be used in gabions shall be of minimum size of SWG 8. Minimum 65 lbs. of wire should be used per hundred (100) square feet of netting of (6" x 4") hexagonal mesh.

Fasteners/binders to be used for wire mesh gabions, such as ring fasteners, shall be formed from wire meeting the same quality and coating thickness requirements as specified for the gabions.

19.3.4.3 *Foundation Preparation for Wire Meshed Gabions*

The foundation on which the gabions are to be placed shall be cut or filled and graded to the lines and grades shown on the drawings. Surface irregularities, loose material, vegetation, and all foreign matter shall be removed from foundations. When fill is required, it shall consist of materials conforming to the specified requirements. Gabions shall not be placed until the foundation preparation is completed, and the subgrade surfaces have been inspected and approved by the Engineer in-Charge.

Compaction of bedding or filter material will be required. The surface of the finished material shall be to grade and free of mounds, dips or windrows.

19.3.4.4 *Assembly and Placement of Wire Meshed Gabions*

Unless otherwise specified in the construction plan, the assembly and placement of gabions shall be in accordance with the following procedures:

Assembly - Rotate the gabion panels into position and join the vertical edges with fasteners for gabion assembly. Where lacing wire is used, wrap the wire with alternating single and double half-hitches at intervals between four (4) to five (5) inches. Where spiral fasteners are used for welded-wire mesh, crimp the ends to secure the spirals in

place. Where ring type fasteners are used for basket assembly, install the fasteners at a maximum spacing of 6 inches. Use the same fastening procedures to install interior diaphragms where they are required.

Interior diaphragms will be installed to assure that no open intervals are present that exceed three (3) feet.

Placement - Place the empty gabions on the foundation and interconnect the adjacent gabions along the top, bottom, and vertical edges using lacing wire, spiral fasteners, or ring fasteners. Wrap the wire with alternating single and double half-hitches at intervals between four (4) to six (6) inches. Ring fasteners shall not be spaced more than six (6) inches apart. Spirals are screwed down at the connecting edges, then each end of the spiral is crimped to secure it in place. Lacing wire will be used as needed to supplement the interconnection of welded mesh gabions, and the closing of lids.

Interconnect each layer of gabions to the underlying layer of gabions along the front, back, and sides. Stagger the vertical joints between the gabions of adjacent rows and layers by at least one-half of a cell length.

19.3.4.5 *Filling Operation of Wire Meshed Gabions*

After adjacent empty woven wire gabion units are set to line and grade and common sides properly connected, they shall be placed in straight line tension and stretched to remove any kinks from the mesh and to gain a uniform alignment. Staking of the gabions may be done to maintain the established proper alignment prior to the placement of rock.

Internal connecting cross-tie wires shall be placed in each unrestrained gabion cell greater than 18 inches in height, including gabion cells left temporarily unrestrained. Two internal connecting wires shall be placed concurrently with rock placement, at each 12-inch interval of depth.

In woven mesh gabions, these cross-ties will be placed evenly spaced along the front face and connecting to the back face. All cross-tie wires shall be looped around two mesh openings and each wire end shall be secured by a minimum of five 180 degree twists around itself after looping.

In welded mesh gabions, these cross-ties or stiffeners will be placed across the corners of the gabions (at 12 inches from the corners) providing diagonal bracing. Preformed hooked wire stiffeners will be used.

The gabions shall be carefully filled with rock, either by machine or hand methods, maintaining alignment, avoiding bulges, and providing a compact mass that minimizes voids. Machine placement will require supplementing with hand work to ensure the desired results. The cells in any row shall be filled in stages so that the depth of rock placed in any one cell does not exceed the depth of rock in any adjoining cell by more than 12 inches. Along the exposed faces, the outer layer of stone shall be carefully

placed and arranged by hand to ensure a neat, compact placement with a uniform appearance.

The last layer of rock shall be uniformly overfilled 1-2 inches for gabions to allow for rock settlement. Lids shall be stretched tight over the rock fill using only approved lid closing tools. The use of crowbars or other single point leverage bars for lid closing is prohibited. The lid shall be stretched until it meets the perimeter edges of the front and end panels. The gabion lid shall then be secured to the sides, ends, and diaphragms with spiral binders or lacing wire wrapped with alternating single and double half-hitches in the mesh openings. Ring fasteners spaced not more than six (6) inches apart may be used for lid closure.

Any damage to the wire or coatings during assembly, placement and filling shall be repaired promptly in accordance with the manufacturer's recommendations or as directed by the Engineer in-Charge. Any damaged gabion shall be replaced with undamaged gabion baskets at the sole cost and responsibility of the contractor.

19.3.5 Spur and Groyne

Spur is an obstruction built across a river projecting from the banks, for training the flow and for the formation of berms. The spurs break up the current and stop erosion by causing silting between the spurs and protect the embankment from damage by flow.

- a. In case of emergency, they shall be constructed of 50 to 80 mm diameter stakes or kilas driven in the river bed, 60 to 120 cm apart center to center in a single row for short depths and in two rows of stakes intertwined for deep canals.
- b. The height shall be up to half the height of the bank for temporary spurs and up to full height of the bank for permanent spurs; known as Groyne.
- c. For best results, these structures shall be placed two to three times their length apart.
- d. Brushwood and twigs shall be filled in between the stakes in alternate layers with stones or sand bags. They are quite successful in the case of small streams and where the soil of the bed is firm but in soft soils will cause scouring.
- e. For slow moving overflow floods in that country, stone pitching, combined with spur bunds would be suitable. The spurs or Groyne shall be built either projecting at right angles with the banks or sloping downstream.

19.3.5.1 Groynes

Spurs of permanent nature and obstructions going right across into a channel are generally called Groyne. The word spur is generally restricted to a short protrusion. Earthen embankments are also made covered with stones, projecting into the river in order to head up water.

- a. Groyne shall be generally 3 to 3.5 m wide at the top with side slopes of 3:1 on the upstream side and 2:1 on the downstream side and section so designed as to cover a hydraulic gradient of 1 in 5 to 1 in 7 depending on the soil.
- b. Groyne shall preferably be constructed for the protection of canal masonry structures especially where the bed is sandy.

19.3.5.2 *Trunger Spur*

Trunger spur is a cage or meshed casing made of about 5 mm steel wire or coir rope 12 to 25 mm dia, which in the case of ordinary size spurs, is made about 7.5 m wide and about one metre higher than the depth of water, is used and the spur so constructed is called trunger. The length of the spur depends upon the width of the river and the scour to be controlled. The filling in the trunger casing may be of anything like small trees, brushwood, dry grass weighed with stone, or it may consist wholly or stones, but in that case the trunger shall be made of wires and not of coir rope. These are also called Gabion mattresses or cages.

19.3.5.3 *Stone Spur*

This type of spur consists of solid stones tilled in the trunger throughout. Stones of size six (6) inches to nine (9) inches shall be laid in the form of a trapezoidal bank protruding into the river.

19.3.5.4 *Brushwood Boulder Spur*

This consists of alternate layers of stone and brushwood. The brushwood shall be intertwined on the sides, so that the bottom and the top of each layer of stone forms a continuous lining and the layer.

19.3.5.5 *Brushwood spur*

Wooden poles (bullies) of 100 mm to 230 mm dia. and of length of about 2.5 m more than the depth of water are driven 1m to 1.2 m in the bed of the river to form an enclosure protruding from the bank. The space in between is filled with freshly cut shrubs. The wooden poles are held together by means of coir or synthetic ropes 25-mm to 40 mm thick.

19.3.5.6 *Tree spurs*

This spur is made of trees alone. Trees 6 m to 12m in height and trunk varying between 45 cm to 120 cm girth may be cut and four or five of them tied to stout iron or wooden pole driven about 12 m to 15 m away from the edge of sour, and are hang upside down along the bank of the river. More trees are then tied in a similar manner to these trees by means of coir ropes or steel wire.

19.3.5.7 Log spur

Logs of wood are laid alternatively in longitudinal and cross direction in layers, one above the other and secured by means of ropes passed round them and fixed to the wooden poles on the sides, wooden poles are driven into the ground.

19.3.5.8 Tree Groyne

Tree Groyne is a steel wire rope 12 mm to 30 mm dia. depending on the length of the river is stretched across the river and anchored at its ends. At intermediate points it is supported on tripods formed of wooden poles. The anchors may be of iron rails embedded in concrete or rough logs laid in a pits of 2.5 to 3 m deep with earth filled over the decking. Usually holes are drilled through the trunks of the trees, and the tying wire in passing through the trunks fixes the trees to the wire rope. The trees begin to collect rubbish floating in the water and form permeable barrier which then collects silt and becomes impermeable.

19.3.6 Construction Program

- a. The Contractor shall programme his construction in such a way that the entire work is completed in dry season and before the river begins to rise due to rain or flood.
- b. If the Contractor fails to complete the work before the river commences to rise and any part of the guide bank gets damaged, it shall be made good by the Contractor at his own cost.

19.4 Measurement and Payment

19.4.1 Measurement

The measurements of pilchi pitching/revetment shall be done along the sloping pitched surface of the bank. The unit of measurement shall be per square feet (square meter).

Measurement for stone pitching in apron or armoured slope will be made to the outlines of the stone pitching in places and for the thickness shown on the plans or established by the Engineer within the lines to which regular excavation or the embankment slope have been measured. The stone pitching shall be measured by volume.

The unit of measurement for stone pitching shall be one cubic feet (cubic meter). The above referred unit rate (s) shall be full compensation for supplying, placing and finishing stone pitching including all materials, labour, tools and plants required for the work.

19.4.2 Payment

The payments for the pilchi pitching/revetment and stone pitching shall be made at the unit rate (s) of the relevant items given in Chapter 19 of Composite Schedule of Rates (CSR), or in the Bill of Quantities with Specified Unit Rates, where applicable.

The above referred unit rate (s) for pilchi, farash or sarkanda pitching shall include;

- i. Procurement of green pilchi, farash or sarkanda of approved quality.
- ii. Their cutting and transportation to the site of work by any means of transport approved by the Engineer within one mile. Carriage beyond one mile shall be paid separately.
- iii. Making rolls of special dimensions to be used both as headers and stretchers including binding wire or coarse munjban whichever has been specified.
- iv. Laying header and stretcher rolls in position as per above specifications.
- v. Putting three feet long killas in position as specified above.

The above referred unit rate for stone pitching includes;

- i. Stone pitching for guide banks and river diversion works.

Notes:

The cost of earthwork including excavation and making embankments shall be paid separately.

The unit rate does not include the supply of killas.

Use of farash shall be avoided, if pitch is available in case of pilchi pitching.

Sarkanda shall be used as a last resort. In case of sarkanda mattress or pitching the distance of pegs shall be reduced as directed by the Engineer or his authorized subordinate to check its tendency of floating.

Table of Contents

20	OUTLETS	2
	20.1 Scope	2
	20.2 Construction Materials	2
	20.2.1 Clay Bricks	2
	20.2.2 Cement	2
	20.2.3 Sand	2
	20.2.4 Water	2
	20.2.5 Cement Mortar	2
	20.2.6 Stones	2
	20.2.7 Concrete	3
	20.2.8 Reinforcement	3
	20.2.9 Formwork	3
	20.3 Construction Requirements	3
	20.3.1 Pipe Outlets	3
	20.3.2 Brick Masonry for Outlets	3
	20.3.3 Stone Masonry for Outlets	4
	20.3.4 Concrete work for Outlets	4
	20.3.5 Shutters for Outlets	4
	20.4 Measurement and Payment	4
	20.4.1 Measurement	4
	20.4.2 Payment	4

OUTLETS

20.1 Scope

This chapter comprises of specifications for the Construction of Outlets on canals i.e. distributerries, minors, etc. mainly for coneyance of water for irrigation puposes, as shown on the plans or where otherwise directed by the Engineer and in accordance with the detailed drawings supplied from time to time, in all respects.

20.2 Construction Materials

20.2.1 Clay Bricks

Clay Bricks shall conform to the requirements set forth in relevant sections of Chapter 4 of Book I.

20.2.2 Cement

Cement shall conform to the requirements set forth in relevant sections of Chapter 3 of Book I..

20.2.3 Sand

Sand shall conform to the requirements set forth in relevant sections of Chapter 6 of Book I..

20.2.4 Water

Water shall conform to the requirements set forth in Chapter 2 of Book I..

20.2.5 Cement Mortar

Cement Mortar shall conform to the requirements set forth relevant sections of Chapter 7 (Brick Masonry) of Book II.

20.2.6 Stones

Stones shall conform to the requirements set forth in Chapter 2 of Book I and relevant sections of Chapter 8 (Stone Work) of Book II.

20.2.7 Concrete

The Materials for Concrete shall fulfil the requirements set forth in relevant sections of Chapter 6 (Concrete) of Book II.

20.2.8 Reinforcement

The Materials for Reinforcement shall fulfil the requirements set forth in relevant sections of Chapter 6 (Concrete) of Book II..

20.2.9 Formwork

The Formwork shall fulfil the requirements set forth in relevant sections of Chapter 6 (Concrete) of Book II..

20.3 Construction Requirements

20.3.1 Pipe Outlets

Concrete pipes of specified diameter and wall thickness as per drawings or directed by the Engineer in charge shall conform to the specifications given in relevant section of relevant sections of Chapter 14 (Pipes) of Book I.. Pipe outlets shall be fixed horizontally and at right angles to the centre line of the channel. Normally their axis shall be kept 09 inches below full supply level (FSL) of the channel except in the main canal or branch canal where it will depend on the fluctuations in the water level. R.L. of axis of pipe outlet must be fixed by double levelling. While Constructing a pipe outlet, if exact size is not available then sockets should be fixed on U/S and D/S ends of the pipe barrel. Coefficient of discharge shall be 6.0 for drowned pipe outlet and 5.0 for free fall pipe outlet.

20.3.2 Brick Masonry for Outlets

In general the construction requirments of the Brick Masonry for the outlets, shall conform to the specficatons set forth in relevant sections of Chapter 7 (Brick Masonry) of Book II.. The inside of the walls of an outlet shall be plastered with 1:4 sand cement mortar. At the bottom of Outlets, a proper channel as per drawings shall be constructed in the whole length of the Outlet and along the centerline of the channel or as per drawings. Outlets shall have cement concrete Class - B benching as per drawings/specs.

Outlets along the main canals or branch canals in irrigation drainage System shall also act as overflow structures called weir. There shall be no deviation from the original drawings.

20.3.3 Stone Masonry for Outlets

In general the construction requirements of the Stone Masonry for the outlets, shall conform to the specifications set forth in relevant sections of Chapter 8 (Stone Work) of Book II.. While other requirements shall be as per specifications given in para 20.3.2 above.

20.3.4 Concrete work for Outlets

In general the construction requirements of the concrete work for the outlets, shall conform to the specifications set forth in relevant sections of Chapter 6 (Concrete) of Book II.. The bed of the constricted section called throat in case of open flume (OF) outlets shall be constructed of concrete as per given drawings & specifications.

20.3.5 Shutters for Outlets

The shutters shall be Class - B reinforced cement concrete, fitted with cast iron frame and with cast iron cover or galvanized Mild Steel (MS) shutters (factory made) to be fixed in the steel recesses already embedded in the concrete during construction as per drawings.

20.4 Measurement and Payment

20.4.1 Measurement

Measurements shall be for the actual number of Outlets as shown in BOQs of the appropriate type constructed at the site as per concerned drawings and specifications laid down in this chapter and to the approval of the Engineer.

The Brick work and concrete work done for the construction of outlets shall be measured in cubic feet. Any steel work shall be measured in tons/kg.

20.4.2 Payment

The rate of all items under this section shall cover the cost of all materials, labor, tools, equipment and appliance and performing all operations for laying, fixing and jointing and all work (including transportation of precast concrete outlets from the factory to the site, if any) as specified in accordance with drawings, bill of Quantities and as directed by the Engineer.

The payments for the Outlets shall be made at the unit rate(s) of the relevant items given in Chapter 20 of Composite Schedule of Rates (CSR), or in the Bill of Quantities with Specified Unit Rates, where applicable.

Table of Contents

21	SINKING OF WELLS	2
21.1	Scope	2
21.2	Material Requirements	2
21.2.1	Concrete	2
21.2.2	Steel Reinforcement	2
21.2.3	Structural Steel	2
21.2.4	Timber	2
21.2.5	Bricks	2
21.3	Construction Requirements	2
21.3.1	Shallow Wells	2
21.3.2	Deep Wells	3
21.3.3	Quality of Water	4
21.3.4	Well Curbs	5
21.3.5	Well Steining	6
21.3.6	Well Sinking	6
21.3.7	Measurement and Payment	7

SINKING OF WELLS

21.1 Scope

The, work to be carried out under this section is the construction of a well to be used as source of potable water for small towns, villages and hamlets. It commonly comprises of five separate operations, the casting of a well curb in proper position, the erection of well steining by stages, the sinking of the erected curb and well steining to the required elevation, the proper plugging of the well all according to the lines, dimensions and forms shown on the plan or as directed by the Engineer.

21.2 Material Requirements

21.2.1 Concrete

Concrete shall conform to the requirements set forth in the relevant sections of Chapter 6 (Concrete) of Book II, Part 1..

21.2.2 Steel Reinforcement

Material for steel Reinforcement shall conform to the requirements set forth in the relevant sections of Chapter 6 (Concrete) of Book II, Part 1..

21.2.3 Structural Steel

Structural Steel shall conform to the requirements set forth in the relevant sections of Chapter 25 (Structural Steel Work) of Book II, Part 2.

21.2.4 Timber

Timber shall conform to the requirements set forth in the Chapter 8 (Timber) of Book I..

21.2.5 Bricks

Bricks for masonry works in well foundations shall conform to the requirements set forth in the relevant section of material requirements of relevant sections of Chapter 4 of Book I..

21.3 Construction Requirements

21.3.1 Shallow Wells

These are usually known as draw wells or dug wells, manually dug,. Whether lined (steining) or unlined, with varying diameters from 2 to 6 meters, are constructed in the uppermost layer of the earth surface and obtain their quota of water from the ground

water table which is generally limited and sometimes even dry up in summer. To have these wells deliver reasonably adequate water, the depth of a well is kept below the water table from 6 to 8 meters. The discharge of a shallow well does not exceed 5 liters per second, in any case. However, the water is not reliable and requires purification. Due to uncertain supply of water, these wells are used as source of water supply for small villages, undeveloped municipal towns, isolated buildings, camps etc.

21.3.1.1 Construction Requirements for Shallow Wells

- i) Soil of every 05 feet depth shall be thoroughly analyzed by a Geologist of the contractor, after digging, to judge the type of soil and submit report if steining would be needed.
- ii) If a Shallow well has been extending beyond seven (7) meters depth or when the soil of wall may not stand firm sticking to its surrounding strata, steining shall be provided, the additional cost of which (per foot depth) may be incorporated in the final bill of the contractor by the Engineer In charge, Prior of any steining, a written approval shall be obtained from the engineer incharge.
- iii) The well cleaned from silt and dirt shall be kept disused for drawing water for three days and covered with a lid. On fourth day, sample of water shall be collected from the well by the contractor, labeled and handed over to engineer incharge for test at laboratory
- iv) The tests of water in the laboratory should fall within the range of tolerance tabulated in main paragraph "quality of water" mentioned above.
- v) The sinking of well shall be done 6 to 8 meters below the water table.
- vi) Where soil strata of a well is unstable, steining shall be provided to a required depth
- vii) Water is tested in the laboratory and If pollution found, water treatment measures shall be adopted.
- viii) The collars of the well shall be raised to a height of two feet above the surface level with brick lining and pollution tight lid provided to cover the well mouth.

21.3.2 Deep Wells

They obtain their quota of water from an aquifer below an impervious layer. The water is usually found purified. However, certain salts get dissolved during travel of water from the outcrop thus making the water hard. As such, hardness is required to be treated.

Deep dug wells can be in two to three segments, the upper most much wide open and the succeeding segment is of less diameter for the purpose of subsequent cleaning and desilting. Each segment may be of 50 to 75 feet depth and the lowermost segment stined if required. Accordingly, the uppermost segments may be stined as well with bricks if the strata are weak.

21.3.2.1 Construction Requirments for Deep Wells

The Engineer in charge shall ensure that;

- i) Test of water in the laboratory are within the range tabulated, otherwise water treatment would be done.
- ix) Where soil strata of a well are unstable, steining would need to be provided to a required depth.
- x) Water is tested in the laboratory and if pollution found, water treatment measures are adopted.
- xi) The collars of the well are raised to a height of two feet above the surface level with brick lining and pollution tight lid provided to cover the well mouth.

21.3.3 Quality of Water

- i) Water required for domestic use should possess a high degree of purity and it shall be free from suspended impurities, bacteria etc.
- xii) A tolerance of small degree of hardness in water due to dissolved salts is permissible. However, in particular, that water shall be accepted to be used for domestic and drinking purposes which is clear, odorless and colorless, free from harmful and disease producing bacteria; free from objectionable substances; fresh, palatable and tasty; and shall not cause erosion to pipes and other fittings.
- xiii) It is not possible to find pure water in nature. It may contain bacteria, germs, and chemical impurities. In order to ascertain the quality of water various tests of water, i.e. physical, chemical and bacteriological tests shall be carded out and only drinking water from wells shall be accepted within the permissible ranges tabulated as under.

Tolerances of Quality of water

Table 21-1: Tolerances of Quality of water

Contents present in Water	Maximum Permissible Quantity/Value
Lead	0.3 to 0.5 PPM
Nitrites contents	Zero PPM
Chloride contents	250 PPM
Fluoride contents	1 mg l litre
Iron and Manganese	0.3 PPM
Arsenic	0.05 PPM
Copper	3.0 PPM
Flourine	1.5 PPM
Count of bacteria	100 numbers/cc*
Coliform organism	10/ litre*
Color	Cobalt scale- 10 to 20 PPM *
pH Value	7-8.5%
Hardness Limit	75-115 PPM*
Turbidity	5-10PPM*
Odor	# 3 on Threshold -Scale*

*These tests are not required in the case of tube well water.

21.3.4 Well Curbs

21.3.4.1 Cutting Edge

Cutting edge of the well curb will be of structural steel, prefabricated and supplied in segments convenient for site assembly by bolting together as per lines and dimensions shown on the plan. The segments of the cutting edge shall be interchangeable. The fitting together shall be checked at the fabrications work by the assembly of at least two complete cutting edges, formed of segments chosen at random before these are accepted for dispatch to the site of work.

None of the steel work is to be painted and no surface preparation is called for other than the removal of rust and loose adhering mill scale.

21.3.4.2 Reinforcing Steel Work

Reinforcing steel work in the cutting edge will be properly bolted to the steel work and placed and assembled as shown on the Plan.

21.3.4.3 Providing and laying of R.C.C Well Curb

Portland cement concrete for the well curb shall be laid with nominal concrete mix of ratio as specified on the drawings or as directed by the Engineer and shall be finished to the form and dimensions shown on the plans/drawings.

21.3.5 Well Steining

Well steining shall be made either of brick work in (1:4) cement sand mortar and of the form and dimensions as shown on the drawings or as directed by the Engineer in charge.

Reinforcing steel work will continue from the cutting edge into the well steining with spacers made of structural steel work consisting of mild steel plates of the size and dimensions as shown on the drawings.

21.3.6 Well Sinking

Well sinking process includes all operations required to sink the well in position and to the required elevation.

21.3.6.1 Positioning

Each well curb shall be correctly positioned in place and approved by the Engineer before commencement of further work.

21.3.6.2 Support

Well curbs shall be adequately supported to prevent shift or tilt during the initial operations of excavation and sinking whether the well has been started on made up ground or in water or in excavation.

21.3.6.3 Excavation for Sinking

The soil from inside the well shall be removed by mechanical grabbing or other device as approved by the Engineer. The accuracy of sinking will be the responsibility of the Contractor.

21.3.6.4 Shift and Tilt

The limit of departure from true vertical position of any well shall not exceed one unit measured horizontally in a vertical distance of sixty units. The maximum horizontal displacement of any well away from its correct position shall not exceed six inches (150 mm).

It will be entirely the responsibility of the Contractor to keep the tilt and shift within the specified tolerances. If the above limits are exceeded, the Contractor will be required to carry out at his own cost suitable approved remedial measures to overcome the adverse effects of such tilts and shifts.

21.3.6.5 *Kentledge*

The sinking effort can be augmented by the use of sand bags and other heavy weights and as aid in correcting errors of tilts and horizontal shift. All precautions will have to be taken to prevent damage to well steining during sinking.

21.3.6.6 *Limits of Sinking*

Each and every well shall be sunk to the elevation indicated on the plan or to any other elevation approved by the Engineer according to the nature of soil strata.

21.3.6.7 *Soil Samples*

The Contractor will have adequate arrangements to the satisfaction of the Engineer to collect disturbed samples of soil at every 10 feet (3 m) elevation and at every change of soil strata and to deliver it in proper bags to the representative of the Engineer.

21.3.7 Measurement and Payment

21.3.7.1 *General*

For the various items of work, constructed under this Section, measurement shall be made as specified in the respective sections. The quantity to be paid, for shall be the original plan quantity measured as provided in the respective sections, except where change has been made by the Engineer and order has been given in writing.

No measurements for or other allowances will be made for work or material for forms, false works, supports, bracings, kentledge, pumping etc.

21.3.7.2 *Well Sinking*

The measurement for the sinking of the well shall be made per linear foot (linear meter) of well of the specified external diameter, sunk below the bed level shown on the Plan. The unit of measurement shall be one cubic foot (cubic meter) and the outer dimension of the well shall form the basis for the measurement.

The payment for measured quantity of sinking of well in cu.ft (cu.meter) shall be made at the relevant unit rate (s) given in Chapter 21 of Composite Schedule of Rates (CSR), or in the Bill of Quantities with Specified Unit Rates where applicable. The above referred unit rate (s) shall include cost of excavation, pumping, support, bracing, kentledge, tilt correction and soil samples etc.

21.3.7.3 *Structural Steel for Cutting Edge*

Structural steel work for the cutting edge shall be measured in kg or tons.

The measured quantity of the structural steel work for the cutting edge of the well curb shall be paid at the relevant unit rate given in Chapter 21 of Composite Schedule of Rates (CSR), or in the Bill of Quantities with Specified Unit Rates where applicable.

The above stated unit rate includes the provision and fixing in position of the structural steel cutting edge for the well curb.

21.3.7.4 *Providing and Laying R.C.C Well Curb*

RCC work for well curb and well steining shall be measured in cu.ft (cu.m) and shall be paid at the relevant unit rate given in Chapter 21 of Composite Schedule of Rates (CSR), or in the Bill of Quantities with Specified Unit Rates, where applicable.

21.3.7.5 *Reinforcement Steel Work*

Reinforcement steel work for well curb shall be measured and paid for according to the requirements of relevant section of Chapter 6 (Concrete) of Book II, Part 1.

21.3.7.6 *Brick Work*

Brick Work in (1:4) cement mortar for steining shall be measured and paid for according to the requirements set forth in relevant section of Chapter 7 (Brick Work) of Book II, Part 1.

Table of Contents

22	SURFACE DRAINAGE SYSTEM	2
22.1	Scope	2
22.2	References	2
22.2.1	BS (British Standards)	2
22.2.2	ASTM (American Society for Testing Materials)	2
22.3	Material Requirements	2
22.3.1	Concrete	2
22.3.2	Brick Masonry	2
22.3.3	Stone Masonry	3
22.3.4	R.C.C. Pipes	3
22.4	Construction Requirements	3
22.4.1	Temporary Drainage during Construction	3
22.4.2	Siting of Culverts	3
22.4.3	Excavation	3
22.4.4	Backfilling	4
22.4.5	Compaction	4
22.4.6	Concrete Work	5
22.4.7	Brick Masonry Work	5
22.4.8	Stone Masonry Work	5
22.4.9	R.C.C. Pipe Lines	5
22.4.10	Measurement and Payment	6
22.5	Hume Pipes	

SURFACE DRAINAGE SYSTEM

22.1 Scope

This part of the specifications covers quality control requirements for the installation; testing and maintenance of storm water drains comprising drainage lines, open drains, box culverts, kerb and gutter, and drainage structures. All the construction materials will meet requirements of standards referred in these specifications. Execution of works shall strictly be in accordance with the drawings and shall meet the requirements of these specifications.

22.2 References

22.2.1 BS (British Standards)

BS 5911: Part 2 Pre-cast concrete pipes, fittings and ancillary products. Specification for inspection chambers

22.2.2 ASTM (American Society for Testing Materials)

ASTM C 76 Standard Specification for Reinforced Concrete Culvert, Storm Drain, and Sewer Pipe

ASTM C 14 Standard Specification for Non-reinforced Concrete Sewer, Storm Drain, and Culvert Pipe

ASTM C 443 Standard Specification for Joints for Concrete Pipe and Manholes, Using Rubber Gaskets

22.3 Material Requirements

Specifications and quality requirements of materials used for works related to this part of the specifications are given as under:

22.3.1 Concrete

It shall conform to the requirements set forth in the relevant sections of Chapter 6 (Concrete) of Book II, Part 1.

22.3.2 Brick Masonry

It shall conform to the requirements set forth in the relevant sections of Chapter 7 (Brick Masonry) of Book II, Part 1..

22.3.3 Stone Masonry

It shall conform to the requirements set forth in the relevant sections of Chapter 8 (Stone Work) of Book II, Part 1..

22.3.4 R.C.C. Pipes

It shall conform to the requirements set forth in the relevant sections of chapter 14 of Book I.

22.4 Construction Requirements

22.4.1 Temporary Drainage during Construction

The Contractor shall make adequate provision for runoff flows at drainage works under construction to avoid damage or nuisance due to scour, sedimentation, soil erosion, flooding, diversion of flow, damming, undermining, seepage, slumping or other adverse effects to the Works or surrounding areas and structures as a result of the Contractor's activities.

The Contractor shall not implement any proposals to dam up or divert existing watercourses (either temporarily or permanently) without the prior approval of Engineer by way of approved Drawings or written instruction. The Contractor's material and equipment shall be located clear of watercourses or secured so that they will not cause danger or damage in the event of large runoff flows.

22.4.2 Siting of Culverts

Before commencing construction of any culvert, the Contractor shall set out on site the culvert inlet and outlet positions to the location and levels shown on the Drawings, and shall present this set-out for inspection by the Engineer. The Engineer may amend the inlet or outlet locations or designed levels or the culvert length to suit actual site conditions. Any activity resulting from such amendments by the Engineer shall be deemed to be included as part of the work covered by the Schedule of Rates.

Should the Contractor propose changes to the culvert location, length, designed levels, culvert strength, conditions of installation or cover to suit the construction procedures, the Contractor shall present the proposed culvert set-out in addition to the designed set-out for consideration by the Engineer. No changes shall be made unless the prior written approval of the Engineer is obtained.

22.4.3 Excavation

Before undertaking storm water drainage excavation, topsoil shall be removed in accordance with the Specification for EARTH WORKS in Chapter 3 of Book II, Part 1 of these specifications.

In undertaking trench excavation, the Contractor shall provide any shoring, sheet piling or other stabilisation of the sides necessary to comply with statutory requirements.

Where public utilities exist in the vicinity of storm water drainage works the Contractor shall obtain the approval of the relevant authority/corporation to the method of excavation before commencing excavation.

If excavation by blasting is permitted by Engineer and the concerned civil authorities, the Contractor shall comply with all the requirements concerning blasting operations in the above referred specification for EARTH WORKS and conditions imposed if any by the concerned civil authorities.

Trench or foundation excavation for storm water drainage works shall be undertaken to the planned level for the bottom of the specified bedding or foundation level. All loose material shall be removed by the Contractor.

Any material at the bottom of the trench or at foundation level which the Engineer deems to be unsuitable shall be removed and disposed in accordance with the above referred specification for EARTH WORKS by the Contractor and replaced with backfill material in accordance with the requirements of this Specification and the Specifications for particular culvert types. The bottom of the excavated trench or foundation, after any unsuitable material has been removed and replaced, shall be parallel with the specified level and slope of the culvert.

The excavated material shall be used in the construction of embankments/backfilling or disposed off in accordance with the Specification for EARTH WORKS in Chapter 3 of Book II, Part 1.

22.4.4 Backfilling

Backfilling shall be carried out in accordance with the requirements of the relevant culverts or drainage structures Specifications and to the compaction requirements specified below.

22.4.5 Compaction

Foundations, bedding (other than for pipe drainage) and backfilling shall be compacted to the following requirements when tested in accordance with BS 6031 and AASHTO T-99 for compaction.

	% of Modified AASHTO
i) Foundations or trench base to a depth of 150 mm below foundation levels	95%
ii) Material replacing unsuitable material	95%

iii) Bedding material (other than for pipe drainage)	95%
iv) Selected backfill and ordinary backfill material	97%
At Subgrade level to 300 mm below	100%
In a pavement zone	

All material shall be compacted in layers not exceeding 150 mm compacted thicknesses. Each layer shall be compacted to the relative compaction specified before the next layer is commenced.

At the time of compaction, the moisture content of the material shall be adjusted so as to permit the specified compaction to be attained at a moisture content which, unless otherwise approved by the Superintendent, is neither less than 60 per cent nor more than 95 per cent of the apparent optimum moisture content.

When compacting adjacent to culverts or drainage structures, the Contractor shall adopt compaction methods which will not cause damage or misalignment to any culvert or drainage structure. Any damage caused shall be rectified, and all costs of such rectification shall be borne by the Contractor.

22.4.6 Concrete Work

For all concrete work, the Contractor shall comply with the Specifications set forth in Chapter 6 (Concrete) of Book II, Part 1 of these Specifications in relation to the supply and placement of specified class concrete and steel reinforcement, formwork, tolerances, construction joints, curing and protection.

22.4.7 Brick Masonry Work

For all types brick masonry work involved in the construction of storm water drains, the Contractor shall comply with the Specifications set forth in Chapter 7 (Brick Masonry) of Book II, Part 1 of these Specifications.

22.4.8 Stone Masonry Work

For all types stone masonry work involved in the construction of storm water drains, the Contractor shall comply with the Specifications set forth in Chapter 8 (Stone Work) of Book II, Part 1 of these Specifications.

22.4.9 R.C.C. Pipe Lines

For R.C.C. pipeline work involved in the construction of storm water drains, the Contractor shall comply with the Specifications for "SEWERAGE & RCC PIPE SEWERS", given in relevant sections of Chapter 14 of Book I.

22.4.10 Measurement and Payment

22.4.10.1 Measurement

The activities of excavation, concreting, brickwork, stone masonry and pipelines shall be measured and paid according to the appropriate units given in the relevant chapters of this book.

22.4.10.2 Payment

The payments shall be made for the measured quantities at the unit rate (s) of relevant items given in Chapter 22 of the Composite Schedule of Rates (CSR), or in the Bill of Quantities with Specified Unit Rates, where applicable.

22.5 Hume Pipes

A hume pipe is a concrete tube with reinforced bar. It was invented by the Hume brothers in Australia in 1910. A hume pipe is formed by pouring concrete into a formwork, and axially rotating it, and allowing it to compact using centrifugal force. A hume pipe can withstand internal and external pressure well, and is primarily used for sewer pipes, agricultural waterways, and residential construction. Anti-bacterial concrete is commonly used in hume pipes.

Table of Contents

23	SEWERAGE	3
23.1	Scope	3
23.2	References	3
23.2.1	BS (British Standards)	3
23.2.2	ASTM (American Society for Testing Materials)	3
23.3	Definitions	3
23.3.1	Black water	4
23.3.2	Branch discharge pipe	4
23.3.3	Discharge stack	4
23.3.4	Drain	4
23.3.5	Drainage system	4
23.3.6	Grey water	4
23.3.7	Ventilating pipe	4
23.3.8	Ventilating stack	4
23.3.9	Waste Water	4
23.4	Reinforced Cement Concrete Pipes	4
23.4.1	General	4
23.4.2	Classes of Pipe	5
23.4.3	Basis of Acceptance	5
23.4.4	Materials	5
23.4.5	Mixing of Concrete	6
23.4.6	Pipe Dimensions	6
23.4.7	Lift Holes Not Permitted	6
23.4.8	Delivery of Pipes at Site	6
23.4.9	Joints for Concrete Pipe Sewers	6
23.5	Construction Requirements	7
23.5.1	Handling of Pipes	7
23.5.2	Excavation, Trenching and Backfilling for Laying R.C.C. Pipe Sewers	8
23.5.3	Laying of Sewers in Trenches	8
23.5.4	Pavement Restoration	10

23.5.5 Tests for Infiltration or Ex-filtration	10
23.5.6 Access to Drainage Pipes in Trenches	11
23.5.7 Provision of Access to Drains	11
23.5.8 Manholes	12
23.5.9 Tolerances	13
23.5.10 Joints	13
23.5.11 Soil, Waste, Vent and Anti - syphonic Pipes	14
23.5.12 Floor Traps	16
23.5.13 Measurement and Payment	17

SEWERAGE

23.1 Scope

This part of the specifications covers quality control requirements for providing, installing and testing of sewerage works generally falling outside the building premises including R.C.C. pipe sewers. All the materials including; but not limited to pipes, fittings and installations shall meet requirements of standards referred to in these specifications. Execution of works shall strictly be in accordance with the drawings and shall meet the requirements of these specifications.

23.2 References

23.2.1 BS (British Standards)

BS 5911	Precast concrete pipes, fittings and ancillary products.
BS 2494	Elastomeric seals for joints in pipe work and pipeline
BS 4660	Un-plasticized polyvinyl chloride (UPVC) pipes and fittings of nominal sizes 110 and 160 for below ground drainage and sewage
BS 5481	Un-plasticized PVC pipe and fittings for gravity sewers
BS 6209	Solvent cement for non-pressure thermoplastic pipe systems

23.2.2 ASTM (American Society for Testing Materials)

ASTM C 76	Standard Specification for Reinforced Concrete Culvert, Storm Drain, and Sewer Pipe
ASTM C 14	Standard Specification for Non-reinforced Concrete Sewer, Storm Drain, and Culvert Pipe
ASTM C 443	Standard Specification for Joints for Concrete Pipe and Manholes, Using Rubber Gaskets
ASTM C 1244	Standard Test Method for Concrete Sewer Manholes by the Negative Air Pressure (Vacuum) Test Prior to Backfill

23.3 Definitions

The terminologies used in this chapter and their applications are defined as under.

23.3.1 Black water

Waste water containing faecal matter or urine

23.3.2 Branch discharge pipe

Pipe connecting sanitary appliances to a discharge stack or drain.

23.3.3 Discharge stack

Main (generally vertical) pipe, conveying discharges from sanitary appliances.

23.3.4 Drain

Near horizontal pipe suspended within a building or buried in the ground to which stacks or ground floor appliances are connected.

23.3.5 Drainage system

A system composed of drainage equipment, and other components collecting waste water and discharging by means of gravity.

23.3.6 Grey water

Waste water not containing faecal matter or urine.

23.3.7 Ventilating pipe

Pipe provided to limit the pressure fluctuations within the discharge pipe system.

23.3.8 Ventilating stack

Main vertical ventilating pipe, connected to a discharge stack, to limit pressure fluctuations within the discharge stack.

23.3.9 Waste Water

Water which is contaminated by use and all water discharging into the drainage system, e.g. domestic and trade effluent, condensate water and also rainwater when discharged in a waste water drainage system.

23.4 Reinforced Cement Concrete Pipes**23.4.1 General**

The reinforced concrete pipes furnished and installed under these specifications shall conform to ASTM Designation C-76 "Reinforced Concrete, Culvert, Storm Drain and

Sewer Pipe", using ' structural steel reinforcement, except for R.C.C. pipes of small diameters up to 9 inches which shall conform to B.S 5911. Non-reinforced concrete Sewer, Storm Drain, and Culvert Pipes shall conform to ASTM C-14

23.4.2 Classes of Pipe

The reinforced cement concrete pipes to be furnished and installed under ASTM C-76 shall be of the strength classes II or class III. The design requirements for these classes of reinforced cement concrete pipe shall be as described in ASTM Designation C-76, Tables II and Table III for classes II and III respectively. All reinforced cement concrete pipes under ASTM C-76 shall comply with the Wall B design requirements as set forth in afore said Table II and Table III of this specification.

23.4.3 Basis of Acceptance

Acceptance of reinforced cement concrete pipes will be on the basis of three edge bearing and material tests as per ASTM Designation C-76 and inspection of manufactured pipes for defects and imperfections. The Contractor shall bear the cost of such tests and pay fees etc. and also pay for the carriage of such samples and all other expenses contingent to tests. The manufacture of the pipes at the factory shall be watched and tested by the authorized representative of the Engineer.

23.4.4 Materials

All materials used in the manufacture of reinforced cement concrete pipes for use under these specifications shall conform to ASTM Designation C-76-72a and also with the following requirements;

23.4.4.1 Cement

The Portland cement which is required to be used in the manufacture of reinforced concrete pipes to be furnished and installed under these specifications shall conform to the 'requirements of ASTM Designation C150 latest revision and be in accordance with the provisions of relevant sections of chapter 3 of Book I of these specifications.

23.4.4.2 Aggregate

The coarse / fine aggregate to be used in the manufacture of concrete pipes to be furnished and installed under this contract shall be generally in accordance with the provisions of chapter 6 of Book I of these specifications of these Specifications.

23.4.4.3 Steel Reinforcement

The material will conform to the specifications given in relevant sections of chapter 6 (Concrete) of Book II, Part 1 of these Specifications.

23.4.5 Mixing of Concrete

The proper types and amounts of Portland cement, mineral aggregates and water shall be thoroughly mixed in an approved type of mechanical batch mixer which shall be kept in first class condition. Admixtures in the concrete will not be permitted.

23.4.6 Pipe Dimensions

The internal diameters and wall thickness of reinforced concrete pipes under these specifications shall be as set forth in ASTM Designation C76-72a in Table II and Table III, "Wall B Pipe" as required and shown on the plans.

The lengths of reinforced concrete pipes under these specifications shall be as required to provide the designated laying length in full, and shall not be less than 6 feet, nor more than 8 feet, unless otherwise approved in writing by the Engineer.

23.4.7 Lift Holes Not Permitted

Lift holes in the walls of reinforced cement concrete pipes will not be permitted under these specifications for the purpose of handling and laying. Other approved lifting methods shall be employed.

23.4.8 Delivery of Pipes at Site

The Contractor shall submit, for approval by the Engineer, necessary plans and certified data sheets to provide complete information on all concrete sewer pipes, dimensions, type anti dimensions of pipe ends, joint details, proposed concrete design mix for each different strength class of reinforced or non-reinforced concrete pipe and any other information needed to demonstrate full compliance with these specifications.

No concrete sewer pipe shall be delivered to the work site until the Engineer has formally approved the plans and data sheets and until all test requirements called for in the respective ASTM Standard Specifications C-76-79 and C-14 have been met.

23.4.9 Joints for Concrete Pipe Sewers

23.4.9.1 General

Joints for concrete sewer pipes of more than 150 mm diameter shall be Rubber Gasket joints as provided in the plans. No other types of joints will be permitted under this contract. For pipes below 150 mm including 150 mm internal diameters collar joints will be used.

23.4.9.2 Rubber Gasket Joints

Rubber gasket joints shall be used for either tongue and groove or bell & spigot pipes.

Rubber gasket joints shall be made using specially designed rubber gaskets, made to fit the applicable tongue and groove or bell and spigot pipes and adequately tested under operating conditions. Special care must be taken in the selection and handling of the concrete pipes for use with rubber gasket joints, to ensure that pipe ends shall be smooth and concentric with tolerance which closely conforms to the requirements of the manufacturer of the rubber gaskets. The tongue or spigot end of each pipe shall be specially designed to perform groove or offsets to fit the manufacturer's rubber gasket design.

The rubber gasket joints shall conform to all applicable requirements of the latest revision of ASTM Designation C443, entitled 'Joints for Circular Concrete Sewer and Culvert Pipe using Flexible Watertight Rubber Type Gaskets', except that the test pressure need not exceed 10 feet of head at which the completed sewers shall meet the infiltration or exfiltration limits set forth hereinafter.

The groove end of tongue and groove pipes of either the reinforced or non-reinforced concrete type shall have at least one line of wire reinforcing of 8 gauge size placed in the center of the groove.

The rubber gasket shall be installed on the pipe in accordance with the instructions of the gasket manufacturer. In general, the gaskets shall be pre-assembled to the pipe at the pipe manufacturing plant. The pipes shall be handled with special care at all times to prevent damage to the pipe ends. A lubricant shall be used for jointing the pipes as recommended by the rubber gasket manufacturer. Care shall be taken to avoid contamination of the gasket and lubricated surfaces with earth or other undesirable material during installation.

For either tongue and groove or bell and spigot pipes mechanical means shall be used to pull the pipe home for all sizes of 12 inch or larger diameter in accordance with the recommendations of the rubber gasket manufacturer. Pipes of 8 inch or smaller diameter may be coupled manually using a cross member and bar. Under no circumstances bars be used alone nor shall any motor driven equipment be used to force the pipe home.

23.5 Construction Requirements

23.5.1 Handling of Pipes

Concrete sewer pipes shall be handled with special care at all times during the manufacture, while transporting to the site of work and while installing. Each pipe shall be carefully inspected before being laid and no cracked, broken or defective pipe shall be used in the work. Chipping of the tongue and groove or bell and spigot pipe ends, which in the Engineer's opinion may cause defective joints, shall be sufficient cause for the rejection of any concrete pipe.

23.5.2 Excavation, Trenching and Backfilling for Laying R.C.C. Pipe Sewers

The excavation, trenching and backfilling for laying R.C.C. pipe sewers, water supply pipe lines should conform to the specifications given in relevant sections of Chapter 3 “Earth Works” of Book II, Part 1 of Technical Specifications.

23.5.3 Laying of Sewers in Trenches

Where socket pipes are required to be laid on a granular or sand bed, or directly on a trench bottom, joint holes shall be formed in the bedding material or final excavated surface to ensure that each pipe is uniformly supported throughout the length of its barrel.

Pipes shall be laid on setting blocks only where a concrete bed or cradle is used.

Where pipes are required to be bedded directly on the trench bottom, the final excavated surface shall be trimmed and levelled to provide even bedding for the pipeline and shall be free from all extraneous matter that may damage the pipe, pipe coating, or sleeving. Where rock is encountered, the trench shall be cut at least 150 mm deeper than other ground and made up with well compacted selected fill material.

No protective cap, disc or other appliance on the end of a pipe or fitting shall be removed permanently until the pipe or fitting which it protects is about to be jointed. Pipes and fittings including any lining or sheathing shall be examined for damage and the joint surfaces and components shall be cleaned immediately before laying.

Suitable measures shall be taken to prevent soil or other material from entering pipes, and to anchor each pipe to prevent flotation or other movement before the works are complete. Where cleaning after laying is difficult because of small pipe size, a suitable swab or drag shall be kept in the pipe and pulled forward past each joint immediately after the jointing has been completed.

Where pipeline marker tape is specified, it shall be laid between 100 mm and 300 mm above the pipe.

Trenches shall be kept free from water until the pipe jointing material has set, and pipe shall not be laid when the condition of the trench or the weather condition is unsuitable for such work. At times when work is not in progress, open ends of pipe and fittings shall be securely and satisfactorily closed so that no trench water, earth, or other substance will enter the pipe and fittings.

In addition to the above specifications following aspects shall also be considered while laying the drainage pipes in trenches.

23.5.3.1 Bedding

- a. Bedding for pipes shall be constructed by spreading and compacting granular bedding material over the whole width of the pipe trench. After the pipes have been

laid, additional material shall, if required, be placed and compacted equally on each side of the pipe.

- b. Bedding material shall be in accordance with Table 21.1 unless otherwise specified in the project documentation.

Table 23-1: Bedding Material

Pipe Diameter	Bedding Material
Up to 65 mm	Sand
65 - 100 mm	10 mm single sized aggregate
100 - 200 mm	10 or 14 mm single sized or 14 - 15 mm graded aggregate
Over 200 mm	10, 14 or 20 mm single sized or 15 – 5 or 20 -5 mm graded aggregate

23.5.3.2 Protective Coatings

Coatings, sheathings or wrappings shall be examined for damage, repaired where necessary, and made continuous before trench excavations are backfilled.

23.5.3.3 Concrete Protection to Pipes

- a. Pipes to be bedded on or cradled with concrete shall be supported on precast setting blocks. The top face of each block shall be covered with two layers of compressible packing complying with BS EN ISO 2505
- b. .Rapid hardening cement shall not be used in concrete for the protection of plastics pipe.
- c. Plastic pipes shall be wrapped with a layer of plastic sheeting complying with a composition in accordance with Clause 3 of BS 6076 and a nominal thickness of 125 microns before being surrounded by concrete.

23.5.3.4 Completion of Pipe Surround

Fill material shall, where required, be placed and compacted over the full width of the trench in layers not exceeding 150 mm before compaction, to a finished thickness of 250 mm above the crown of the pipes.

23.5.3.5 Pipes under Buildings

- a. Where a pipe has less than 300 mm of cover under a load bearing slab, it shall be surrounded with concrete as an integral part of the slab. Where possible, the concrete surround shall be poured at the same time as the slab. The surround shall be tied to the slab with nominal steel reinforcement placed vertically with turned over ends.

- b. No provision for pipe flexibility along the concrete surround shall be made, unless an expansion joint is included in the slab.
- c. In normal, stable ground conditions, and with 300 mm or more of cover to the pipeline beneath the slab, a total granular surround can be used as a pipe bedding.
- d. Flexibility shall be incorporated into the pipeline as it leaves any concrete surround.

23.5.3.6 *Crossing of water lines*

Where sewers cross above water line the sewer pipe for a distance of 3 meter (10 feet) each side of the crossing shall be of cast iron steel or other acceptable pressure pipe and with no joint closer than 3 feet (900 mm) to the crossing, or shall be fully encased in concrete of min. 15 cm. (6") thickness.

23.5.4 Pavement Restoration

The contractor shall restore paved surfaces which have been cut for the installation of the sewer pipe line, as part of the work under the excavation items and at no extra cost to the Owner/Client.

23.5.5 Tests for Infiltration or Ex-filtration

23.5.5.1 *General*

All sewers built under these specifications shall be tested for infiltration or ex-filtration as specified below. The Contractor shall furnish labour, materials and equipment required for making the tests with no extra compensation over and above the agreed contract price for laying the sewers. The tests shall be made at times selected or approved by the Engineer. Sections of the completed sewer shall be isolated and measurements of the infiltration or ex-filtration shall be made by approved methods.

23.5.5.2 *Infiltration Tests*

The sewers which are constructed with the ground water level above the crown of the pipe shall be tested for infiltration after the sewers have been installed and backfilling has been substantially completed. The tests and measurement shall be performed by the Contractor in the presence of and in a manner approved by the Engineer. The duration of the tests shall be only long enough to establish the true rate of infiltration. The amount of leakage over a 24 hours period will then be calculated from the result of the measured true rate of infiltration.

23.5.5.3 *Ex-filtration Tests*

The sewers which are constructed with the ground water level below the crown of the pipe shall be tested for ex-filtration by isolating a section of sewers between manholes

by means of approved temporary type of water tight bulk heads. The method of testing for ex-filtration shall be generally as follows:

- a. After isolation of sewer section, it shall be filled with water to a level which is one meter above the crown of the sewer at the higher end of the isolated section under test. The level will not be more than 6 feet above the crown of the sewer pipe at its lower end.
- b. The duration of the ex-filtration test shall be one hour after the filling with water has been completed.
- c. Determination of the amount of ex-filtration shall be made by measuring the total loss of volume of water in the manholes.
- d. The amount of ex-filtration over a 24 hours period will then be calculated from the measured loss of volume during the test observation period.

23.5.5.4 Allowable Infiltration or Ex-filtration

The calculated amount of infiltration or ex-filtration over a 24 hours period shall not exceed 75 litres per mm of pipe diameter per km of sewer, which rate shall be applied to the actual sewer size and length tested to determine the allowable infiltration or ex-filtration over the 24 hours period.

If the measured infiltration or ex-filtration exceeds the specified allowable limit, then the Contractor shall locate the points of leakage and make necessary repairs so as to reduce the leakage to less than permissible maximum stated above.

23.5.6 Access to Drainage Pipes in Trenches

Rodding eyes shall be constructed in pipe work of the same diameter as the drains it serves and should connect to the drain at an angle not steeper than 45° from the horizontal.

23.5.7 Provision of Access to Drains

Every drain length should be accessible for maintenance and rodding. Access should be provided at the head of each run of a drain and at changes in direction, gradient or pipe diameter.

Table 23-2: Maximum Spacing's of Access Points

Distance to	From junction or Branch	From Inspection Chamber	From Manhole
Start of external drain	-	22 m	45 m
Rodding eye	22 m	45 m	45 m

Distance to	From junction or Branch	From Inspection Chamber	From Manhole
Inspection chamber	22 m	45 m	45 m
Manhole	45 m	45 m	90 m

23.5.8 Manholes

23.5.8.1 Location and Spacing

Manholes shall be installed:

- At the end of each line
- At all changes in grade, size, or alignment
- At all intersections
- At distances not greater than 120 m (400 ft) for sewers of 375 mm diameter (NPS-15) or less and 150 m (500 ft) for sewers of 450 mm diameter (NPS-18) to 750 mm diameter (NPS-30), except that distances up to 185 m (600 ft) may be considered in cases where adequate modern cleaning equipment for such spacing is provided.

Greater spacing may be permitted for larger sewers. Cleanouts may be used only for special conditions and should not be substituted for manholes nor installed at the end of laterals greater than 45 m (150 ft) in length.

23.5.8.2 Drop Type

A drop pipe shall be provided for a sewer entering a manhole at an elevation of 610 mm (24 in) or more above the manhole invert. Where the difference in elevation between the incoming sewer and the manhole invert is less than 610 mm (24 in), the invert should be filleted or benched to prevent solids deposition.

Drop manholes shall be constructed with an outside drop connection. Inside drop connections (when necessary) should be secured to the interior wall of the manhole and provide access for cleaning.

The entire outside drop connection should be encased in concrete due to the unequal earth pressures that would result from the backfilling operation in the vicinity of the manhole.

23.5.8.3 Precast Manholes

The jointing material for precast manholes shall be mortar or proprietary bitumen or resin mastic sealant, with the concrete surfaces primed with an appropriate sealant. The jointing material which is extruded inside the manhole shall be trimmed off and joints pointed on completion.

Units which bed onto bases shall be manufactured so that imposed vertical loads are transmitted directly via the full wall thickness of the unit.

For joints underside of slabs, joint profiles shall be capable of withstanding applied loadings from such slabs.

23.5.8.4 Diameter

A minimum access diameter of 610 mm (24 in) should be provided. Large diameters shall be preferable for large diameter sewers.

23.5.8.5 Water Tightness

Manhole adjustment rings should be sealed with no shrinking mortar.

Inlet and outlet pipes should be joined to the manhole with a gasket flexible watertight connection that allows differential settlement of the pipe and manhole wall to take place.

Watertight manhole covers shall to be used wherever the manhole tops may be flooded by street runoff or high water.

23.5.8.6 Access

Manhole steps should be 400 mm (16 in) aluminium or galvanized rungs and should be provided at a spacing of 300 to 400 mm (12 to 16 in).

Safety chains should be provided on the downstream side of manholes for sewers larger than 1200 mm in diameter (NPS-48).

Safety landings shall be provided.

23.5.8.7 Corrosion Protection for Manholes

Where corrosive conditions due to septicity or other causes are anticipated, corrosion protection on the interior of the manholes should be provided.

23.5.9 Tolerances

Tolerances in manufacturing of materials have already been discussed under relevant parts of specifications of construction materials for water supply and sanitation.

23.5.10 Joints

- a. All plain and reinforced concrete pipe shall be free from imperfections of any kind and shall have a smooth and dense finish.
- b. Standard strength pipe and extra strength plain concrete pipes shall conform to the requirements of ASTM C14.

- c. Reinforced concrete sewer pipes shall conform to the requirements of ASTM C-76.
- d. All the joints shall conform to the requirements of ASTM C -443.
- e. Special PVC or clay liner plates, coatings of coal-tar, coal-tar epoxy, vinyl or epoxy mortar may be applied for corrosion protection.

In addition to the above specifications following aspects shall also be considered while jointing the sewer pipes, where required;

- i) The jointing of pipes with collars shall be done first with spun yam rope (dipped in hot maxphalt composition) fitted in between the ends of pipes and pressed together. The dia of rope shall not exceed 19mm (3/4") or as directed by Engineer. The collar shall then be brought in the middle of the joint. Wooden wedges shall be placed at two or three places around the pipe so that the collar may have uniform gap all-round the pipe for pressing pipes together. At a time five or six pipes shall be joined together. After putting bitumen soaked hemp rope suitable jacks and wedges or any other approved method shall be used. The inside of the collar and outside portion of the pipe shall be cleaned with brush and cement mortar of 1:1 proportion shall then be inserted from both ends of the collar. The mortar containing as little quantity of water as possible shall be carefully inserted by hand into the joints and tightly pressed with caulking tool. The mortar shall be finished off on the outside at an angle of 45 degree.
- ii) The wooden wedges shall be carefully removed and mortar filled in the cavity before finishing. The joints shall be protected from weather and maintained wet for at least ten days and shall not be covered with backfill until the joints have been tested and approval given by the Engineers.
- iii) For jointing of pipes with spigot and socket joints, the first pipe shall be bedded with the socket end upstream. The interior surface of the socket shall be carefully cleaned with a wet brush and its lower portion filled with mortar to such a depth as to bring together the inner surfaces of the abutting pipes flush and even. All further joints shall be made in this manner. The remainder of the socket joint shall be filled in with mortar and well pressed with the help of caulking tool. The mortar shall be finished smooth on the outside at an angle of 85 degree. The joints shall be protected and cured as for collar joints.

23.5.11 Soil, Waste, Vent and Anti - syphonic Pipes

- a. Examination and preparation of pipes shall be as for RCC pipes given above.
- b. The pipes shall run exposed or embedded in walls and floors as specified or shown on drawings. Where embedding in walls or floors is required, the necessary instruction and route of pipe work shall be approved by the Engineer. Pipes

running exposed on walls and ceiling shall be properly clamped with Hangers, support and clamps for passage of pipes through masonry wall and RCC beams, slab and walls, pipe sleeves shall be embedded and properly caulked and water proofed.

- c. Horizontal soil and waste pipes unless otherwise specified shall be given a grade of 6.4mm (1/4") and 3.2 mm (1/3 11 lift. respectively. All main vertical soil stacks shall extend full size to above the roof line, except where otherwise indicated. The part of soil stacks carried up as vent pipe shall not have bend or angle except when unavoidable, in which case, the angle shall be as obtuse as possible. The vent stack shall joint the soil stack 'at point not Jess than 3 feet (900 mm) above the highest connection to the soil stack. Horizontal waste lines receiving the discharge from two or more fixtures on the first floor shall be provided with end vents, unless separate venting of fixtures is called for.
- d. Changes in pipe size on soil waste and drain lines shall be made with reducing fittings or recessed reducers. All changes in direction shall be made by the appropriate use of 45 degree Wyes, long or short sweep 3 mm to 1 .5 mm bends etc. or equivalent fittings as approved. Single and double sanitary tees and quarter bends may be used in drainage lines only where the direction of flow is from horizontal to vertical. Short sweep not less than 75 mm (3") in diameter may be used where the change in the direction of flow is either in plan or vertical to horizontal and may be used for making necessary offsets between the ceiling and the next floor above. The use of short sweep bends or fittings, where deemed necessary because of installation conditions, shall be subject to the approval of the Engineer.
- e. Contractor shall provide offsets in the piping where required or directed by the Engineer to avoid interference with other work, or to increase the headroom under piping, or to improve the appearance of the pipe work. Piping shall be installed in such a manner that will permit freedom of movement during expansion and contraction without causing the pipes to be warped and adequately insulated against noise transmission through pipe work in habitable rooms.
- f. All piping shall be installed in such a manner as to prevent delay or interference with the work of others working in the same area. Ali openings in pipes shall be kept closed during construction work with plugs.
- g. Slip joints shall be permitted only in trap seals or on the inlet side of the traps. Tucker or hub drainage fittings shall be used for mating union connections wherever practicable. The use of long screws and bushing is prohibited.
- h. Clean-out shall be of the same size as the pipe except that clean-out-plugs larger than 100 mm (4")) will not be required. Clean-outs installed in connection with cast-iron spigot and socket pipe shall consist of a long sweep 1/4" bend or one or two

1/8" hands extended to any easily accessible place, or, where indicated on the drawings. An extra heavy cast-brass ferrule with outer sunk trap screw cover shall be caulked into the hub of the fitting and shall be flush with the floor. Where clean-outs in connection with threaded pipe are indicated and are acceptable, they shall be cast iron drainage T-pattern 90 degree branch. Fittings with extra-heavy brass screws plugs of the same size as the pipe up to and including 100mm (4"). Test less with cast iron clean-out plugs shall be installed at the footing of all soil, waste, and drain stacks and on each building drain outside-the building. In addition, clean-outs shall be provided at all changes of direction in excess of 45 degree and at distance not exceeding 15 meter (50 feet) in horizontal drain line 100mm (4 ft.) and smaller size, and not exceeding 30.48 meters (100 feet) in drain lines larger than 100 mm (4"). Underground clean-outs shall be extended to an accessible location, to the surface of the floor above or to grade, subject to approval of the Engineer. Panels and plates for access to clean-outs shall be provided.

- i. Each Fixture and piece of equipment, including floor drain, requiring connections to the drainage system shall be equipped with a trap. Traps are to be supplied with the fixtures. Each trap shall be placed as near to the fixtures as possible and no fixture shall be double-trapped. Except as otherwise indicated traps installed on bell and spigot pipe shall be cast iron. Traps installed on threaded pipe shall be recess-drainage pattern.

23.5.12 Floor Traps

- a. Floor traps with gratings shall be made of high grade, strong, tough, and even grained metals, Castings shall be free from blow holes porosity, hard spots, excessive shrinkage cracks, or other defects, shall be smooth and well cleaned both inside and outside. Casting shall not be repaired; plugged, brazed, or burned. The wall thickness of iron casting shall be not less than 6.4mm (1/4").
- b. Joints for Cast Iron soil, waste and vent, +H2 pipes shall be made with lead, jute, hemp or hempen spun yarn. The packing material shall be well placed into the annular space so as to prevent the entrance of lead into the pipe. Run lead joints shall be applied to perfectly dry pies. Under wet condition lead fiber joints shall be y- made both with quantities and depth of jointing materials and by method as per B.S. Code C.P. 301 (1950). The remainder of the space shall be filled with molten lead that is hot enough to show a' rapid change in color when stirred. The lead shall be caulked to form a tight joint without over-straining the bell.

23.5.13 Measurement and Payment

23.5.13.1 Measurement

- a. All pipes and fittings shall be classified according to their types, diameters, jointing and fixing. Pipes of different types and different types of joints shall be taken separately. The diameter shall be the nominal diameter of the internal bore.
- b. Pipes shall be measured in running feet (meters) net as laid or fixed with overall fittings such as bends, junction, etc., which shall not be measured separately. The length shall be measured along the centre line of the pipes and fittings. Testing of pipe line shall be included in the item.
- c. Cutting through walls, floors etc. and making good shall be included with the item.
- d. Manholes and inspection chambers shall be fully described and enumerated. They shall be classified into different groups depending upon the depth, which shall be the distance between the top of the manhole cover and the inverted level of the main drain.
- e. Gully traps, separators, interceptors and clean outs shall be separately measured.

23.5.13.2 Payment

Total length as measured including pipe and specials, etc. shall be paid for the total length at the unit rate (s) of the relevant item (s) given in Chapter 23 of Composite Schedule of Rates (CSR), or in the Bill of Quantities with Specified Unit Rates, where applicable.

Payment for special items shall be made at the applicable unit rate (s) per number given in Chapter 23 of Composite Schedule of Rates (CSR), or in the Bill of Quantities with Specified Unit Rates, where applicable.

Table of Contents

24	TUBE WELLS AND WATER SUPPLY SYSTEM	2
	24.1 Scope	2
	24.2 TUBE WELLS	2
	24.2.1 Construction Materials	2
	24.2.2 Execution of Work for Tube Wells	3
	24.2.3 Measurement and Payment	17
	24.3 WATER SUPPLY SYSTEM	21
	24.3.1 References	21
	24.3.2 Definitions	22
	24.3.3 Submittals/Samples	24
	24.3.4 Quality Assurance and Testing	24
	24.3.5 Material Requirements for Water Supply	30
	24.3.6 Construction Requirements for water supply	37

TUBE WELLS AND WATER SUPPLY SYSTEM

24.1 Scope

The work covered by 1st part of this Chapter of the Specification shall consist of all plant, labour, equipment, appliances, materials etc. as necessary for the drilling of bore hole, installation of materials, tube well completion, development, testing and miscellaneous works required for the satisfactory completion of all works involved with the construction of tube wells for water supply system.

The 2nd part of this chapter covers quality control requirements for the provision, installation and testing of pipes, fittings and accessories such as valves and other equipment for water supply and its distribution. All the materials including, but not limited to pipes, fittings and accessories shall meet requirements of standards referred in these specifications. Execution of works shall strictly be in accordance with the drawings and these specifications or as directed by the Engineer.

24.2 TUBE WELLS

24.2.1 Construction Materials

Specifications and quality requirements of materials used for works related to this part of the specifications are as under.

24.2.1.1 Pump Housing Pipe

Pump Housing Pipe shall be of mild steel of designated diameters and wall thickness indicated in the drawings or given in the Bill of Quantities with Specified Unit Rates, where applicable. The pipes shall be made from steel plates conforming to ASTM Specifications A-53/79.

The pipes shall have bevelled ends. The pipe shall be furnished in standard lengths of 16 ft. (5 m) and shall be painted outside with antirust chemical. All pipes shall be free from dents, injuries, scars and oval ties.

The housing pipe shall be installed to extend a minimum 3' (1 m) above ground level in addition to the housing as specified by the final design below ground level.

24.2.1.2 Well Blind Pipe

Well blind pipes shall be fabricated in conformity to specifications designated here above for pump housing pipes. Well blind pipes shall be of designated diameters as indicated in the drawings.

24.2.1.3 Reducer

For connecting M.S. housing pipe and well blind pipe at depths below ground level a transitional reducer shall be provided and made of the same material and of the same thickness as used for well casing specified above. The ends of the reducer shall be suitable for welding to the pump housing and well blind pipe.

24.2.1.4 Sand Trap

Sand trap shall be of the same material and thickness as followed for well casing. Sand trap shall be provided with a base plate, welded at one end of the pipe. A steel hook bent in the form of 'U' shall be bolted to the base plate to sustain a maximum suspended length of 500 ft. (150 m) of well casing. Sand trap shall be 10 ft. (3 m) long in sizes as indicated in the drawing.

24.2.1.5 Well Screen

Well screen shall be of brass screen suitable for gravel pack tube well and strong enough for location at a depth not exceeding 400 ft. (120 m) below ground level. The strainer shall have minimum open area of 10 percent, minimum wall thickness of 0.25 inch (6 mm) and slot size of 0.04 inch. (1 mm) The slots shall be of a shape that produces an opening of a 'V' form, narrow on the outside and wide on the inside. The openings shall be free from jagged edges, irregularities or anything that will accelerate or contribute to clogging or corrosion of the screen.

24.2.2 Execution of Work for Tube Wells

24.2.2.1 Drilling of Bore Hole

24.2.2.1.1 General

The Contractor shall drill each bore hole for water supply wells at the location established in the field by the Engineer. The Contractor shall prepare the site for the construction of the tube well and shall provide for the disposal of water, cuttings, and refuse from his operations away from the tube well. Bore hole shall be drilled by any of the methods explained below unless otherwise specified by the Engineer.

24.2.2.1.2 Drilling of Bore hole by Percussion Method

In this method, the well hole is made by percussion, i.e. by hammering and cutting. This method is very useful for cutting consolidated rocks from soft clay to hardest rocks, and is generally unsuitable in loose formations, such as unconsolidated sands and gravels or quick sands.

This method becomes ineffective in loose materials, because the loose material slumps and caves around the drilling bit. The drill bit has a chisel sharp edge, which breaks the rocks by impact when alternately lifted and dropped. This drilling bit is connected at the

lowest end of the entire 'falling and rising arrangement' known as string of tools. From top to bottom, the string of tools consists of a rope socket, a set of jars, a drill stem, and the drilling bit.

Tools are made of steel and joined with tapered box and pin screw joints. The entire assembly weights several tonnes. The most important tool of the entire assembly is the drilling bit (or drill) as it does the actual rock cutting. The drill stem is the long steel bar which adds weight and length to the drill, so that it can cut rapidly and vertically.

The set of jars have no direct effect on the drilling. They only loosen the tools when they stick in the hole. A rope or a cable is fastened at the upper end to the rope socket and to a dead man (or a heavy weight) at the lower end.

The entire assembly of tools is suspended from an assembly of a mast and a walking beam, etc. This assembly, known as drilling rig, in turn, is generally mounted on a truck, so as to make it easily portable. The mast should be sufficiently high, so as to allow the longest of tools to be hoisted.

As the drilling proceeds, the tools make 40 to 60 strokes per minute, from a height of 0.4 to 1 m. Water is sometimes added in the hole, so as to form a paste with the cuttings, thus reducing friction on the falling bit. After the bit has cut 1 to 2 m through a formation, the string of tools is lifted out, and the hole is cleaned and cleared of the cuttings by means of a bailer. The process is known as bailing out the hole.

A bailer essentially consists of a pipe with a valve at the bottom and a ring at the top. When lowered into the well, the valve permits the cuttings to enter the bailer but prevents them from escaping the bailer. After it is filled with cuttings, it is lifted up to the surface and emptied.

In unconsolidated formations, casing should be driven down and maintained near the bottom of the hole to avoid caving. Casing is driven down by means of drive clamps fastened to the drill stem. The up and down motion of the tools, striking the top of the casing, protected by a drive head, sinks the casing. On the bottom of the casing, a drive shoe is fastened to protect the casing, as it is being driven.

24.2.2.1.3 Drilling of Bore hole by Direct Rotary Method

This is the fastest method of drilling, and is especially useful in unconsolidated formations. The method involves a continuously rotating hollow bit, through which a mixture of clay and water or mud is forced. The bit cuttings are carried up in the hole by the rising mud.

No casing is required during drilling, because the mud itself makes a lining on the walls of the hole, preventing it from caving.

The drill bit is connected to a hollow steel rod (or drill stem), which, in turn, is connected at the top to a square rod, known as the Kelley. The drill is rotated by a rotating table

which fits closely around the Kelley, and allows the drill rod to slide down, as the hole progresses.

The Rotary drilling rig, consists of a mast, a rotating table, a pump for forcing the mud, a hoist and the engine. The mud, after it emerges out of the hole, is carried to a tank where the cuttings settle out, and the mud can be repumped into the hole.

After the drilling is completed, the casing is lowered into the hole. The clay, deposited in the well-walls during mud pumping, is removed by washing it with water. Water containing some chemicals like sodium hexametaphosphate is forced through the drill rod, and the washings come out through the perforations of the casing. When the washing at one level is completed, the bit is raised and the process repeated.

24.2.2.1.4 Drilling of Bore hole by Reverse Rotary Method

Reverse rotary method is quite useful for making large wells (diameter up to 1.2 m app.) in unconsolidated formations.

The tool usually used for Reverse rotary Method consists of a hollow drill, a drill pipe, and water swivel. In this method, the cuttings are removed by water through a suction pipe called drill pipe. The equipment consists of a mast or a derrick, a centrifugal pump, necessary water and power equipment, and the requisite casing pipe.

The hole is driven by pumping water under pressure through the drill bit, while it is churned up and down. The walls of the hole are supported by hydrostatic pressure acting against a film of fine grained material deposited on the walls by the drilling water. Cuttings are removed by water, and after the mixture (water + cuttings), comes out to the surface, it is passed through a settling tank.

The sand settles out here, but the fine grained particles are recirculated, so as to help in stabilising the walls. After the drilling is completed, the casing is lowered into the hole. The clay, deposited in the well-walls during mud pumping, is removed by washing it with water. Water containing some chemicals like sodium hexametaphosphate is forced through the drill rod, and the washings come out through the perforations of the casing. When the washing at one level is completed, the bit is raised and the process repeated.

24.2.2.1.5 Precautions and Preventive measures during drilling of Bore hole

The bore holes shall be drilled sufficiently straight and plumb so that the pump and tube well casing may be installed concentric with the hole and within the tolerance specified for plumbness of the casing. Waste materials from the drilling operation shall be disposed off in a manner approved by the Engineer.

The Contractor shall be responsible for protecting the tube well from contamination by foreign material until the completion of the tube well. The Contractor shall bear any

expense that may result from damage to any tube well, tools, or equipment that may be caused by caving, washing, or other disturbances within the tube well.

Where necessary to prevent sloughing and caving of surface material, the Contractor shall furnish and install a conductor casing with a minimum diameter 2" (50 mm) greater than the bit diameter not less than 6" (150 mm) above the ground surface up to a sufficient depth to encounter firm material. The conductor casing shall be new or used pipe of adequate strength for the purpose. After the drilling is completed, the conductor casing shall be removed by the Contractor and shall remain his property.

If unstable material is encountered during drilling, the Contractor shall stabilize the material in a manner approved by the Engineer. The use of drilling fluid additives or other suitable materials specially approved by the Engineer may be employed in stabilizing the bore hole. All temporary casing shall be removed by the contractor in 5 to 10 feet (1.5 to 3 m) stages as ground shrouding is placed.

If in the opinion of the Engineer, it is necessary to discontinue work on any bore hole because it is out of line more than the amount specified or on account of jammed tools, caving ground, or because of negligence on the part of the Contractor, the Contractor shall drill another bore hole at an alternative location designated by the Engineer. The Contractor will not be entitled to payment for any work done or materials furnished for bore holes abandoned as a result of his operation or negligence.

24.2.2.1.6 Data and Records

The Contractor shall keep an accurate drilling log or well log of each bore hole including a description of all materials encountered and their location in the bore hole. The fact that the Engineer or his representative may be present and may be keeping a separate record shall not release the Contractor from this responsibility.

In the case of defective or incomplete records the Contractor shall complete the records at his own expense. All records and data shall be kept by the Contractor on forms approved by the Engineer. The Contractor shall deliver to the Engineer the original of all records.

24.2.2.1.7 Sampling

Representative ditch samples or cuttings of the material penetrated shall be taken at every 5' (1.5 m) interval or at each change in lithology encountered whichever is less of the bore hole. Special care shall be exercised to determine the thickness and location of each change in material encountered and to obtain satisfactory samples.

Immediately upon taking each sample, the sample shall be placed in a plastic or cloth bag, partitioned wooden box or other approved container, properly marked for identification, and plainly labelled with the depth of the top and bottom of the section of the bore hole represented. The containers shall be furnished by the Contractor.

The method of obtaining, processing, and storing the samples will be subject to approval by the Engineer. The Contractor shall deliver all samples to the Engineer at the site of the tube wells, except that when requested to do so by the Engineer, the Contractor shall deliver specified samples to the Engineer's field headquarters.

24.2.2.2 Installation of Well Casing and Screens

24.2.2.2.1 General

Installation of casing shall consist of all work required in connection with the installation of casing pipe, comprising mild steel housing pipe, blind pipe, reducer, sand trap and brass screen required for each tube well as specified herein or on the Drawings or as directed by the Engineer and shall include, but not be limited to storing, fabricating and installing all pump housing and tube well casing including concentric reducers.

24.2.2.2.2 Fabrication

The depth of pump housing casing will be established by the Engineer for each tube well depending on the future water levels and draw down anticipated. Lengths of the specified diameter of steel casing shall be provided to extend the pump housing casing from the elevation of the top of the pump housing casing to the depth established by the Engineer.

Adjoining sections of pump housing casing shall be assembled by field welding. The ends of the casing sections shall be lathe turned or otherwise prepared for jointing. All field welding shall be performed by the electric arc method, using heavily coated welding rods suitable for all position welding. After being welded, the welds shall be cleaned of slag and shall show uniform smooth sections, feather edges without overlap, and free from porosity and clinkers. The pump housing casing shall be connected to the tube well casing by means of a concentric tapered reducer having a minimum length of 24 inches (600 mm).

The length and sizes of tube well casing to be installed shall be specified for each tube well by the Engineer and shall be sufficient to extend from the bottom of the housing casing to the bottom of the tube well. The bottom of the tube well casing shall be provided with bail plug as shown on the drawings.

The tube well casing shall consist of slotted sections for installation opposite water yielding formations and plain pipe sections or bail plug opposite non-water yielding formations as directed by the Engineer.

24.2.2.2.3 Installation

The Contractor shall install the entire pump housing and tube well casing assembly straight, plumb, and concentric in the drilled hole to permit the installation of the pump in such a manner that it will operate satisfactorily and without damage. The methods employed by the Contractor in the installation of the casing and in obtaining or

correcting the verticality and straightness of the pump housing casing shall be subjected to the approval of the Engineer.

Centralizers, spacers or other suitable devices shall be attached to the tube well casing so that it will be centered in the drill hole throughout its entire length and held in such position while gravel shrouding is being placed. Centralizers shall be attached to the pipe in a manner that ensures that the pipe is accurately centered in the drill hole. The detail design of centralizers and the method of attachment to the pipe shall be subject to the approval of the Engineer. Unless otherwise directed centralizers shall be spaced at no more than 60 ft (18 m) along the overall length of screen and casing assembly.

The Contractor shall install the pump casing so that the deviation of its axis from the vertical shall not exceed 4 inches at the bottom of the pump housing casing. Measurements for determination of verticality and straightness of the pump housing casing shall be made by the Contractor in the presence of the Engineer upon completion of the gravel shrouding.

Measurements for determining the deviation of the pump housing casing from the vertical shall be made by the use of a circular plumb having a minimum outside diameter of 1 inch less than the inside diameter of the pump housing casing. The plumb shall have vertically and shall be suspended in the centre of the pump housing casing from a point 10 ft. (3 m) above the top of the casing. When the plumb is lowered to the bottom of the pump housing casing, the line from which the plumb is suspended shall not deviate from the centre of the pump housing casing at the top by more than corresponding to a deviation of the plumb 4" (100 mm) at the bottom of the pump housing casing. All deviations shall refer to a vertical line passing through the centre of the pump housing casing to the top of the pump housing casing.

Straightness shall be determined by lowering a section of pipe 40 ft. (12 m) long or a dummy of the same length to the bottom of the pump housing casing. The minimum diameter of the pipe or dummy shall be 1" (25 mm) less than the inside diameter of the pump housing casing. If a dummy is used, it shall consist of a rigid spindle with three cylindrical rings, each ring having a height of at least 12" (300 mm). The rings shall be true cylinders and shall be located at each end and in the centre of the dummy. The central shaft of the dummy shall be rigid so that it will maintain the alignment of the axis of the cylindrical rings. The pump housing casing shall be sufficiently straight so the pipe or dummy can be passed freely throughout the entire length of the pump housing casing. Plumbs, pipes and dummies used in these tests shall be approved by the Engineer.

Any tube well failing to meet the specified requirements for straightness, verticality and concentricity shall be abandoned, and the Contractor shall construct a new well at his own expense at an alternative site designated by the Engineer.

After completion of installation of the pump housing casing and approval of the installation by the Engineer, the Contractor shall paint the letter and number designation of the tube well on that portion of the pump housing casing which projects above the ground surface. All paint, brushes, stencils and other materials required shall be furnished by the Contractor. The characters shall not be less than 6" (150 mm) shall be painted with lines 1" (25 mm) wide, and shall be positioned on the casing in accordance with the Engineer's instructions.

24.2.2.2.4 Gravel Makeup Pipe

A 2" (50 mm) diameter galvanized steel gravel makeup tremie pipe with capped upper end shall be attached to the upper pump house casing to extend from 3 feet (1 m) above ground level to penetrate the full length of the upper grout seal.

The tremie pipe shall be attached to the pump house casing by means of welded straps spaced no less than to provide four support straps spaced over the length of the pipe. Support shall be sufficient to hold the pipe in place until placement of the upper grouted seal has been completed.

The configuration shall be in accordance with the drawings and the pipe shall be located so as to be at 90 degrees to the direction of the pump outlet.

24.2.2.3 Gravel Shrouding

24.2.2.3.1 General

Gravel shrouding shall consist of all work required in connection with supply and placing of gravel shrouding in annular space between the walls of the drilled hole and the outside of the pump casing. The work shall include, but not limited to development of source, excavation, stock piling, grading, washing, storing, transporting and placing of gravel shrouding as specified herein or as directed by the Engineer.

24.2.2.3.2 Gravel Source

The Contractor may obtain gravel from any source or location subject to the approval of the Engineer provided that the gravel meets the requirements of the specifications. The Employer will not be responsible for the amount of work involved or the amount of materials wastage in order to obtain the required amount of gravel of proper gradation.

24.2.2.3.3 Specifications for Gravel

The gravel shrouding shall be clean, washed, water worn, hard, well rounded of siliceous material and without platy particles free from gypsum shale under no circumstances shall contain more than 5% of calcareous material. The gravel supplied shall be subject to inspection and screening in the field to ensure proper gradation suitable to the formation.

The gravel shall be reasonably graded and shall conform to the following requirements:

Table 24-1: Typical Grading

Sieve Size	Percentage passing
3/8 inch	100
No.4	75-100
No.8	35-65
No.14	05-30
No.16	00-15
No.35	00-0

24.2.2.3.4 Placing of Gravel

Gravel shall be placed at constant rate using tremie pipe, hoppers or other similar devices to provide a continuous and uniform gravel flow so as to minimize segregation of particle sizes. When tremie pipe or hoppers are used, gravel shall be introduced in the annular space between the pump-housing and the edge of the hole at two points located 180° apart.

The tremie pipe, when used, shall be of suitable size and lowered to the bottom of the well on two opposite sides of the bore hole and calculated quantity of gravel shall be poured in the pipe through a funnel and the pipe shall be raised by 6 ft. (2 m) interval. In all cases water shall be circulated steadily during gravel placement by inserting the drilling rod into pump housing and operating the circulation pump on the drilling rig. The water level in the annular space outside the pump housing shall be maintained at or above natural ground surface level by return flow from the cutting bit.

Temporary casing, if used, shall be carefully withdrawn in 6 to 10 ft. (2 to 3 m) interval during placement of gravel shrouding and the gravel shall be introduced so that each stage of the hole above bottom of the casing is completely filled before the casing is withdrawn to the next stage. The process of withdrawing the temporary casing shall be continued until the bottom of temporary casing is at least 10 ft. (3 m) above the top of the top most screen. Above this point the temporary casing shall be removed.

24.2.2.4 Grouting of Pump Housing Casing

24.2.2.4.1 General

Grouting of pump housing casing shall cover providing all equipment, labour and doing all work required to seal the annular space between the pump housing casing and the

bore hole face by the introduction of grout as specified herein and on the Drawings according to procedures approved by the Engineer.

24.2.2.4.2 Material

The grouting operation shall be done with 1:2 cement sand mortar. Cement and sand shall conform to the requirements set forth in chapter 6 (Concrete) of Book II, Part 1.

24.2.2.4.3 Placement of Grouting

The grout may be placed by either the tremie method or by being pumped into place provided that both the method and the type of grout are approved by the Engineer prior to the start of the operation.

If the tremie method is selected and approved the grout material shall be placed by tremie pouring, (after water or other drilling fluid has been circulated in the annular space sufficient to clear obstructions).

The tremie method shall be used where there is a minimum annular space of 3 inches (75 mm) only between the upside surface of the inside casing and the inside surface of either the external casing or the borehole. The minimum size tremie pipe utilized shall be 2 inches (50 mm) inside diameter. Where concrete grout is used the minimum size tremie pipe used shall be three inches (75 mm) inside diameter.

When making a tremie pour, the tremie pipe shall be lowered to the bottom of the zone being grouted and raised slowly as the grout material is introduced. The tremie pipe shall be kept full continuously from start to finish of the grouting procedure, with the discharge end of the tremie pipe being continuously submerged in the grout until the zone to be grouted is completely filled.

The minimum curing time before construction may be resumed is 72 hours. If the method of grout placement selected and approved is to be by pumping, the grout shall be injected (after water or other drilling fluid has been circulated in the annular space sufficient to clear obstructions) in the annular space between the inner casing and either the outer casing or the borehole. The annular space must be a minimum of 1-1/2" (38 mm) for sand and cement of neat cement grout, and not less than three times the size of the largest coarse aggregate used.

The grout pipe shall extend from the surface to the bottom of the zone to be grouted. The grout pipe shall have a minimum inside diameter of one inch for sand cement of neat cement grout. It shall have a minimum diameter of 1-1/2" (38 mm) for concrete grout.

Grout shall be placed, from bottom to top, in one continuous operation. The grout pipe may be slowly raised as the grout is placed but the discharge end of the grout pipe must be submerged in the emplaced grout at all times until grouting is completed.

The grout pipe shall be maintained full, to the surface, at all times until the completion of the grouting of the entire specified zone. In the event of interruption in the grouting operation, the bottom of the pipe should be raised above the grout level and should not be re-submerged until all air and water have been displaced from the grout pipe and the pipe flushed clear water. Curing time before construction may be resumed is minimum 72 hours.

24.2.2.4.4 Development of Tube wells

Development shall consist of all work required in connection with the development of each tube well to produce the design capacity of sand free water with a minimum drawdown, and the testing of each tube well to determine the effectiveness of the development operations as specified herein.

Development and testing shall include, but not be limited to surging, backwashing and pumping the tube well at higher than rated capacity; testing the tube well for specific capacity, sand content and degree of development and disinfection and sealing each tube well.

The Contractor shall be required to sound the well, to determine whether excess sand has accumulated in the bottom of the well at the following stages of the work:

- On completion of the casing and screen installation
- Before the starting of the development and
- After completion of development and testing

If it is found at any stage mentioned above that the well contains more than 3 ft. of sand or other material in the bail plug, the Contractor shall clear the well down to a level approximately 3 ft. (1 m) above the bottom plate of the bail plug.

Water obtained in development and testing shall be disposed off by the Contractor in an approved manner. No separate payment will be made for the first 20 hours of development and testing for each tube well. Development and testing ordered by the Engineer in excess of 20 hours per tube well will be paid for at the quoted unit price for this item.

The Contractor shall maintain a complete record of the development operation and shall make regular periodic measurements of discharge rates, sand content and water level measurements. The procedures used shall include back washing and pumping at 1.5 times the rated capacity and may include surging or similar procedures determined by the Contractor. The Contractor shall notify the Engineer following the completion of the 6 hours pumping period that the tube well is ready for testing.

In wells where bentonite or other formation stabilizing agents are used, the Contractor shall undertake a programme of cleaning the well with poly phosphates or other

dispersing agents in a manner and with chemical dosages as approved by the Engineer prior to starting normal development work.

The development procedure and methods used for development of the tube wells shall be established by the Contractor subject to approval by the Engineer. However few commonly adopted Tube well development methods are briefly discussed below:

24.2.2.4.5 Tube well development by surging

In this method, a plunger is worked up and down in the well, so that water is alternately forced out into the surrounding formation and then allowed to flow back into the well. A surge block or surge plunger is the tool, which is used for this purpose.

The above action loosens the fine sand or gravel particles near the screen, and carries fine particles into the well, from where they are removed.

24.2.2.4.6 Tube well development by pumping

In this method, a tube well may be developed either by over pumping or by rewhiding the well.

Over pumping involves heavy pumping of the well to cause heavy drawdown. This is not a very effective method for well development, because the flow of water remains unidirectional, thus not removing bridging of particles.

Rewinding involves starting and stopping of pumping intermittently to produce relatively rapid changes in the head of the well. While this may be done with any type of pump, it is most effectively done with a turbine type of pump installed with a foot valve.

24.2.2.4.7 Tube well development by compressed air

This method is most commonly adopted for developing wells; and may involve either, back washing technique, or surging technique. A combination of both the techniques may sometimes be used for more effective development.

Back washing technique involves forcing of the well water back into the aquifer by means of compressed air introduced into the well through the top of the casing after it has been closed. When the pressure is released, the water will flow back into the well through the screen to bring fine particles from the area surrounding the well, thus ensuring its removal. The process is continued till no sand is brought in.

Surging technique involves the principles of both the pumping method and the surging method described earlier. The inrush of compressed air creates a powerful surge within the well, and loosens the fine material surrounding the perforations, which may then be brought into the well by continuous air injection. The operation is repeated at intervals along the screened section of the well, until sand arrival is stopped. The principle of pumping is the same as described earlier.

24.2.2.4.8 Tube well development by jetting

Jetting with water at high velocity is an effective method of well development. The method involves operating a horizontal water jet inside the well in such a way that the high velocity water streams shoot out through the screen openings. Fine particles are thus washed out of the aquifer, and the turbulence created by the jet brings these fines back into the well through the screen openings above and below the point of operation.

By slowly rotating the jetting tool, and by gradually raising and lowering it, the entire surface of screen can be covered.

24.2.2.5 Testing of Tube wells

The contractor shall test each tube well under the supervision of the Engineer as described herein. Upon completion of the development operations the tube well shall be permitted to recover for a minimum period of one hour. During this recovery period, the tube well shall be sounded. If the comparison of the depth by sounding and the length of the casing string indicate that there is more than 6.00 feet of material in the tube well, it shall be cleaned to within 2.0 feet (600 mm) of the bottom of the casing by bailing.

At the end of the first five minutes of pumping, the sand content of the water shall be determined by using a 40 inches (1000 mm) Imhoff cone or other device approved by the Engineer. The sand content of the water at this time shall be less than 100 mg/l. A second sand content determination shall be made 10 minutes after the start of pumping. The sand content at this time shall be less than 30 mg/l. If the sand content tolerances are exceeded at this time, or at any subsequent time up to the time of final acceptance of the installation, sand content determinations, water level, and discharge measurements during the remainder of the one hour sand test period shall be made as directed by the Engineer.

When the sand test has been satisfactorily completed, the tube well shall be further developed for 4 hours by surging and backwashing with the test pump at five to ten minute intervals. Following the development period, the tube well shall again be pumped for a period of one hour during which time the sand test shall be repeated.

The specific capacity of the tube well shall be determined from the water level measurements and flow rates obtained during the pumping periods. If the specific capacity obtained from the second pump test is found to be more than 10 percent greater than that obtained in the first pump test, the development shall be continued as directed by the Engineer.

Upon satisfactory completion of the above one hour pumping period the tube well shall be permitted to recover for a period of one hour. Upon the completion of this recovery period, a four hour multiple step pump test shall be performed by pumping the tube well for one hour at each of approximately four equal increments.

24.2.2.5.1 Equipment

The Contractor shall furnish all necessary equipment for testing the tube well, including a water lubricated or oil lubricated test pump, a valve for fine adjustment of the discharge, an electric measuring device to determine the drawdown during each stage of the test and Imhoff cones to measure sand content.

If oil lubricated test pumps are used, the contractor shall exercise all reasonable precautions to keep the leakage of lubricating oil into the tube well at a minimum and shall promptly remove all oil which collects on the water surface in the tube well by the addition of detergents or other suitable chemicals and pumping the emulsified oil from the tube well.

In the event the Contractor fails to keep the leakage of oil into the tube well within acceptable limits or to promptly remove oil accumulations from the tube well, the Engineer will order the use of oil lubricated test pumps discontinued and the Contractor shall use water lubricated pumps for testing of the tube wells.

The actual depth of setting for the test pump will be determined by the Engineer after the tube well has been developed. Piping, gauges, orifices, meters, wire boxes or other measuring devices shall be furnished, installed and removed by the Contractor and will remain his property.

All measuring devices and testing equipment shall be subject to approval by the Engineer.

24.2.2.5.2 Measurement and Data

The Contractor shall take drawdown and discharge measurements and other pertinent data during each test at intervals as specified by the Engineer. All such data shall be recorded on forms approved by the Engineer, and the original of such forms shall be delivered to the Engineer at the completion of the development and testing operations.

The contractor shall collect water sample from tube well, after completion of the development and testing. Water samples shall be completely tested from any approved laboratory and result shall be submitted to the engineer at the completion of the tube well.

24.2.2.6 Disinfection and Sterilization

After development and testing of the tube well has been satisfactorily completed, and when approved by the Engineer, the Contractor shall disinfect the tube well by dispersing chlorine solution throughout the entire depth of the well to obtain a minimum chlorine content of 50 mg/l. The procedure and equipment used to introduce and disperse the chlorine in the tube well shall be subject to approval by the Engineer.

24.2.2.7 Sealing of the Well

Upon completion of the tube well the Contractor shall seal the tube well with a 1/4" (6 mm) thick steel plate cap welded to the pump housing at few points using Arc welding, or by some other method approved by the Engineer. Compliance with this requirement will not relieve the Contractor of his responsibility for the safeguarding of any part of the tube well completed until the Certificate of Acceptance is issued for the entire tube well installation.

24.2.2.8 Summary of Development and Testing Procedure

The following is a summary of the development and testing procedure:

Development

Development time	6 hours (minimum)
Recovery	1 hour (minimum)

Testing

Pumping Period	1 hour
Development	4 hour
Pumping period	1 hour
Recovery	1 hour (minimum)
Step pumping	4 hour
Pumping period	2 hours

24.2.2.9 Supply & Installation of Deep Well Turbine Pump & Electric Motor

24.2.2.9.1 Scope of Work

The work covered by this section of the specification includes supply and installation of electric driven Deep Well Turbine Pump along with electric motor of suitable horsepower coupled through hollow shaft, complete with accessories i.e. foot valve with strainer, suction pipe 10 feet long, back valve with bypass connection, sluice valve, pressure gauge with cock and nipple, water meter of suitable size, star delta starter, main switch volt and amp meter etc.

The work shall be executed in accordance with the specifications described herewith

24.2.2.9.2 Design, Manufacture and Supply of Deep Well Turbine Pump & Motor

Pump shall be of the vertical turbine type and shall be suitable for use with vertical, hollow-shaft totally enclosed squirrel cage, induction type motor. The pump shall consist of pump bowl assembly, including water pre-lubrication system or equivalent as required and all other parts and appurtenances to provide a complete operating pump.

24.2.2.9.3 Installation of Pumping Machinery and Equipment

Adequate foundation shall be constructed for pumps and motors for the required performance.

The Contractor shall chain, assemble, align and install the pumps, motors and all equipment and accessories including piping and fittings in good workman like manner and in accordance with the manufacturer's recommendations.

Material and equipment used in all electrical works shall be new, latest standard product of a manufacturer regularly engaged in the production of such material for at least 10 years.

All electrical works including motors, switches and starters etc. shall be grounded as per requirements of Electricity Department. After completion of the installation of deep well turbine pump and electric motor and all equipment, the whole installation shall be put to trial operation and commissioning.

The Contractor shall be responsible for trial maintenance for a period of one month before taking over of the whole installation and works by the Engineer. During this period all the expenses of power, lubricants, skilled and unskilled labour, supervision and all other charges shall be borne by the Contractor. During this period the Contractor shall remove and replace all defective parts of machinery, equipment and other works at his own cost. The performance of the pump, motor and other accessories during this period shall be same as per accepted performance curves supplied by the Contractor along with his tender.

24.2.3 Measurement and Payment

24.2.3.1 Drilling

Measurement and payment for drilling will be made in accordance with the provisions given hereafter.

24.2.3.1.1 Measurement

Measurement for drilling of tube wells will be made of the actual depth in feet (meters) of each bore hole drilled, measured from the top of pump pedestal for the depth of bore hole specified by the Engineer. No measurement will be made of over drilling required because of sloughing, caving ground or for the Contractor's use in setting casing; for tube wells abandoned due to jammed tools, caving ground or negligence on the part of the Contractor; or for tube wells not constructed in accordance with all the requirements of these Specifications.

No measurement for taking soil samples after every 5 ft. (1.5 m) depth. It is included in the relevant rate (s) for drilling of bore hole given in Chapter 24 of Composite Schedule of Rates (CSR) or in Bill of Quantities with Specified Unit Rates where applicable.

Two samples of water shall be taken from each bore hole and submitted to the approved testing laboratory by the Contractor as per relevant item of Chapter 24 of Composite Schedule of Rates (CSR) or in Bill of Quantities with Specified Unit Rates, where applicable.

No measurement for providing and fixing of MS cap to cover the pump housing. It is included in the relevant rate (s) for drilling given in Chapter 24 of the Composite Schedule of Rates (CSR), or in Bill of Quantities with Specified Unit Rates where applicable.

No measurement for providing and fixing MS cap to cover the pump housing and providing and laying block of concrete to house casing. These are also included in the relevant rate (s) for drilling given in Chapter 24 of the Composite Schedule of Rates (CSR), or in Bill of Quantities with Specified Unit Rates, where applicable.

24.2.3.1.2 Payment

Payment will be made for the depth of bore hole per linear foot (linear meter) as per relevant rates given in the Chapter 24 of Composite Schedule of Rates (CSR), or in Bill of Quantities with Specified Unit Rates where applicable and shall constitute full compensation for all the works related to the item.

24.2.3.2 Installation of Tube Well Casing

Measurement and payment for installation shall be made in accordance with the provisions given hereafter.

24.2.3.2.1 Measurement

Measurement for installation of casing will be made of the total length in feet (meter) of pump housing and tube well casing actually provided & installed in the tube well, including length of concentric reducers. The measurement of length will be taken from the elevation of the top of the pump housing casing to the bottom of the tube well casing. For measurement of length, concentric reducers will be considered as casing. No measurement will be made of centralizers, bail plugs or other accessories required for the complete installation.

24.2.3.2.2 Payment

Payment will be made for the actual cased depth at the unit price per foot (per meter) as per relevant rate given in the Chapter 24 of Composite Schedule of Rates (CSR), or in Bill of Quantities with Specified Unit Rates where applicable. and the unit rate shall constitute full compensation for all the works related to the item.

24.2.3.3 Gravel Shrouding

Measurement and payment for gravel shrouding shall be made in accordance with the provisions given hereafter:

24.2.3.3.1 Measurement

Measurement for payment shall be made of the depth in feet (meter) of gravel provided & filled, as shown on the Drawings and as directed by the Engineer.

24.2.3.3.2 Payment

Payment will be made for the actual depth of gravel shrouding at the unit price per linear foot (per linear meter) as per relevant rate given in the Chapter 24 of Composite Schedule of Rates (CSR), or in Bill of Quantities with Specified Unit Rates where applicable, which shall constitute full compensation for all the works related to the item.

24.2.3.4 Grouting of Pump Housing Case

Measurement and payment for grouting shall be made in accordance with the provisions given hereafter:

24.2.3.4.1 Measurement

Measurement for payment will be made for the theoretical volume of grout provided & placed, as shown on the drawings and as directed by the Engineer.

24.2.3.4.2 Payment

Payment will be made for the volume of grout measured as above at the Unit price per linear foot (per linear meter) as per relevant rate given in the Chapter 24 of Composite Schedule of Rates (CSR), or in the Bill of Quantities with Specified Unit Rates where applicable, which shall constitute full compensation for all the works related to the item.

24.2.3.5 Development and Testing

Measurement and payment for development, testing, disinfection and sealing shall be made in accordance with the provision given hereafter.

24.2.3.5.1 Measurement

Measurement for payment for development and testing of the tube well will be made in terms time taken for testing and development of the tube well in hours.

24.2.3.5.2 Payment

Payment for the accepted development, testing disinfection and sealing work shall be made on the basis of total time taken in hours. This price and payment shall constitute full compensation for all operations including furnishing all plant, tools, machinery, material, labour, for the number of hours taken for the development and testing, disinfection and all incidentals to complete the work. Payment shall be made as per relevant rate given in the Chapter 24 of Composite Schedule of Rates (CSR), or in the Bill of Quantities with Specified Unit Rates where applicable.

24.2.3.6 *Supply and Installation of DWT Pump and Electric Motor*

Supply and installation of electric driven Deep Well Turbine (DWT) Pump along with electric motor of suitable horsepower coupled through hollow shaft, complete with accessories i.e. foot valve with strainer, suction pipe 10 feet long (3 m), back valve with bypass connection, sluice valve, pressure gauge with cock and nipple, water meter of suitable size, star delta starter, main switch volt and amp meter etc.

24.2.3.7 *Rate for Payment*

Payment for the supply and installation work as per above mentioned specifications shall be made at the relevant unit rate (s) given in Chapter 24 of the Composite Schedule of Rates (CSR) or in the Bill of Quantities with Specified Unit Rates where applicable. This payment and the above referred unit rate (s) shall constitute full compensation for all operations including furnishing all plant, tools, machinery, material, labour, testing and all incidentals to complete the work.

24.3 WATER SUPPLY SYSTEM

24.3.1 References

24.3.1.1 BS (British Standards)

BS EN 805	Water supply. Requirements for systems and components outside buildings
BS EN 6700	Design, installation testing and maintenance of services supplying water for domestic use within buildings and their cartilages-Specification
BS 750	Underground fire hydrants and surface box frames and covers
BS 5546	Specifications for installations of gas hot water supplies for domestic purposes
BS 1452-3	Plastics piping systems for water supply and for buried and above-ground drainage and sewerage under pressure. Unplasticized poly (vinyl chloride) (PVC U). Fittings
BS 681-1	Elastomeric seals. Material requirements for pipe joint seals used in water and drainage applications. Vulcanized rubber
BS 4346-3	Joints and fittings for use with unplasticized PVC pressure pipes. Specification for solvent cement
BS 598	Ductile iron pipes, fittings, accessories and their joints for sewerage applications. Requirements and test methods
BS EN 969	Ductile iron pipes, fittings, accessories and their joints for gas pipelines. Requirements and test methods
BS EN12201-2	Plastic piping systems for water supply. Polyethylene (PE). Pipes
BS 3505	Specification for un-plasticized polyvinyl chloride (UPVC) pressure pipes for cold potable water
BS EN 1329	Plastics piping systems for soil and waste discharge (low and high temperature) within the building structure. Un-plasticized poly (vinyl chloride) (UPVC), Specifications for pipes, fittings and the system
BS 437	Specification for cast iron spigot and socket drain pipes and fittings
BS 2035	Specification for cast iron flanged pipes and flanged fittings
BS EN 545	Ductile iron pipes, fittings, accessories and their joints for water pipelines. Requirements and test methods

BS 4346	Specifications for Joints and fittings for use with un-plasticized PVC pressure pipes
BS 1211	Specification for centrifugally cast (spun) iron pressure pipes for water, gas and sewage

24.3.2 Definitions

The terminologies used in this chapter and their applications are defined as under;

24.3.2.1 Working pressure

The maximum pressure that the system will operate at, normally measured as the incomings mains pressure after any pressure reducing valve.

24.3.2.2 Backflow

Flow upstream, that is in a direction contrary to the intended direction of flow, within or from a water fitting.

24.3.2.3 Chase

Recess cut into an existing structure.

24.3.2.4 Cistern

Fixed, vented container for holding water at atmospheric pressure.

24.3.2.5 Contamination

Reduction in chemical or biological quality of water due to a change in temperature or the introduction of polluting substances.

24.3.2.6 Direct hot water supply system

Hot water supply system in which the water supplied to draw-off points is heated by a direct source of heat.

24.3.2.7 Distributing pipe

Pipe (other than a warning, overflow or flushing pipe) conveying water from a storage cistern or from hot water apparatus supplied from a cistern and under pressure from that cistern.

24.3.2.8 Duct

Enclosure designed to accommodate water pipes and fittings and other services.

24.3.2.9 Dwelling

Premises, buildings or part of a building providing accommodation, including a terraced house, a semi-detached house, a detached house, a flat in a block of flats, a bungalow, a flat within any non-domestic premises.

24.3.2.10 Indirect hot water supply system

Hot water supply in which the water supplies to draw-off points is heated by an indirect cylinder or calorifier.

24.3.2.11 Overflow pipe

Pipe from a cistern in which water flows only when the level in the cistern exceeds a predetermined level.

24.3.2.12 Pressure relief valve

Pressure-activated valve which opens automatically at a specified pressure to discharge fluid.

24.3.2.13 Servicing valve

Valve for shutting off, for the purpose of maintenance, the flow of water in a pipe connected to a water fitting or appliance.

24.3.2.14 Sleeve

Enclosure of tubular or other section of suitable material designed to provide a space through an obstruction to accommodate a single water pipe and to which access to the interior can be obtained only from either end.

24.3.2.15 Stop valve

Valve, other than servicing valve, used for shutting off the flow of water in a pipe.

24.3.2.16 Storage cistern

Cistern for storing water for subsequent use, not being a flushing cistern.

24.3.2.17 Temperature relief valve

Valve which opens automatically at a specified temperature to discharge fluid.

24.3.2.18 Terminal fitting

Water outlet device.

24.3.2.19 Vent pipe

Pipe, open to the atmosphere, which exposes the system to atmospheric pressure.

24.3.2.20 Warning pipe

Pipe from a cistern in which water flows only when the level in the cistern is about to exceed the predetermined overflow level to warn of impending overflow.

24.3.2.21 Tank

Closed vessel holding water at greater than atmospheric pressure.

24.3.3 Submittals/Samples

- a. The contractor shall provide manufacturer's specifications for all items to be supplied under this part.
- b. The contractor shall provide shop drawings for the installation of piping, pumps, valves, strainers, cisterns etc.
- c. The contractor shall prepare a detailed testing and inspection program, including method statements, and submit it to the Engineer for approval. This program shall identify each item to be tested, the type of test to be performed and the date and time of the test.
- d. Prior to commencement of works on site Contractor shall submit shop drawings for approval to the Engineer.
- e. All drawings shall have plans and sections and shall have sufficient details to clearly reflect the installation of the system. All material specifications shall be provided on the drawings. All information required for preparing suitable foundation, for providing suitable access to the system, for making openings in building structure, for coordination with electrical, air-conditioning and other designs etc., shall be clearly provided.
- f. The contractor shall prepare test record sheets for all tests undertaken. The format of the test record sheet shall be sent for approval from Engineer. On successful completion of a test, the test record sheet shall be signed and stamped by all parties. The Engineer shall retain the original test record sheet.
- g. The submittal shall include catalogue pages, erection descriptions and manufacturers data.

24.3.4 Quality Assurance and Testing

Water supply system shall be installed and tested in accordance with the respective specifications and the requirements specified hereinafter.

24.3.4.1 General Testing Procedure

24.3.4.1.1 Record

Inspections and tests shall be undertaken as installation proceeds, and on completion.

Records of all tests undertaken shall be kept by the Contractor and handed over to the Engineer on completion or as required by the Engineer.

24.3.4.1.2 *Timing of tests*

The timing of tests shall be as follows:

Interim tests: These shall be carried out on completion of the particular section.

Final tests: These shall be carried out on completion of all work on the water system and prior to handing over.

Satisfactory completion of an interim test shall not constitute a final test.

24.3.4.1.3 *Re-tests*

Items failing any test shall be corrected immediately and shall be re-tested before further work proceeds.

24.3.4.1.4 *Inspection*

- a. All pipe work shall be inspected to ensure that it has been securely fixed.
- b. During inspection of underground pipe work, particular attention shall be paid to the pipe bed, the line and level of the pipe, irregularities at joints, the correct fitting of air valves, washout valves, sluice valves and other valves together with any other mains equipment specified, including the correct installation of the thrust blocks where required and it shall be ensured that protective coatings are undamaged.
- c. Trenches shall be inspected to ensure that excavation is to the correct depth.
- d. No part of the pipe trench shall be backfilled until these conditions have been satisfied and the installations seen to conform to the drawings and specifications.

24.3.4.2 *Testing Procedure for Pressure Piping System*

Water supply pressure pipe line system shall be installed and tested in accordance with the requirements of BS EN 805. The testing procedure shall be carried out in the following steps;

24.3.4.2.1 *Flushing*

- a. The Contractor shall provide facilities for flushing the lines. Water for flushing the lines shall be obtained from the potable water supply system. Flushing of line shall be done section by section. For each section of valved water line, the Contractor shall make a temporary hose connection between the water pipe line and the pipe line under test.

- b. Water shall be pumped from the existing system to the section flushed. Other arrangements for storing and pumping of water shall be subject to the approval of the Engineer. Due precaution shall be taken by the Contractor for the disposal of water. The pipe line shall be flushed by keeping all the branching lines open. Flushing shall be continued until clean water starts flowing through the other end. Section by section, the entire pipe line shall be flushed at a minimum velocity of 0.75 meters/sec.

24.3.4.2.2 Leakage Test

- a. Flushing of the pipe line shall be followed by a leakage test. The Contractor shall provide facilities for the performance of leakage test. Water and pumping facilities shall be provided by the Contractor. Before the testing of pipe line, the Contractor shall ensure that concrete backing blocks have been provided where necessary. The test shall be performed only after all the concrete work in contact with the pipe to be tested has set for a minimum of 24 hours. All joints shall be left exposed. The leakage test shall be performed by keeping the end of the pipe line closed by proper plugs blocked to resist 150 percent of the test pressure. While filling the line, all valves and openings shall be kept open and the water shall be filled in slowly.
- b. When the pipe line is completely filled with water and all air expelled, water shall be pumped into the line to a minimum pressure of 6 Kg/cm. square (85 psi) and the test pressure shall be maintained for at least 2 hours. Each and every joint shall be inspected for leaks and for all visible leakage tests, a displacement leakage test shall be performed by the Contractor for the newly laid pipe line. The pipe line shall be filled with water and all the air from the pipe line shall be expelled. A measured quantity of water shall be pumped into the pipe line and the pressure of 6 Kg/sq cm (85 psi) shall be maintained for two hours. No piping installation shall be accepted until the leakage is equal to or less than the number of imperial gallons per hour as determined by the following formula:

$$L = 0.00045 N \times D \times P$$

where,

L = Leakage in imperial gallons

N = Number of joints

D = Nominal diameter of pipe in inches

P = Average test pressure during the test in psi

- c. In the event of pipe line failing the leakage test, the Contractor shall locate and repair the defective pipe, fitting or joint at his expenses. For dewatering the line for repairs, the Contractor shall follow the instructions given by the Engineer for the disposal of water. After repairs of the line, the Contractor shall re-test the line. The

line will not be accepted until it passes the leakage test.

- d. All pipelines in course of or after laying and jointing but before being covered, shall be tested hydraulically, using a test pump fitted with accurate pressure gauge to the approval of the Engineer to 400 feet head of water, or such other test head (at least 50 percent above the working pressure as shall be fixed by the Engineer to suit the particular conditions of the work.
- e. All pipes, specials and fitting with their joints shall remain perfectly water tight under the full test head for a period of not less than one hour after the whole length of the pipe line has, been examined and demonstrated to be water tight.

24.3.4.2.3 Final Test after Backfill

- a. The test as specified above shall be repeated at a time to be determined by the Engineer after the pipelines have been cleaned, inspected and backfilled. The entire line shall be subjected to a leakage test as a whole unit. Particular care must be taken to isolate air valves, etc., not to apply higher pressure than specified at any point on the pipeline and to ensure that the pipelines are adequately anchored before the test is carried out.
- b. The Contractor shall repair the line if it fails to pass the leakage test requirements specified hereinbefore. The test shall be repeated and repairs affected until the pipe line passes the leakage test.

24.3.4.3 Testing Procedure for Domestic & Industrial Piping Systems

The testing procedure of domestic and industrial piping systems shall be as follows as described in BS EN 806-4. The testing procedure is given below;

24.3.4.3.1 Hydraulic Testing

Defects revealed by any of the following tests shall be remedied and the tests shall be repeated until a satisfactory result is obtained.

24.3.4.3.2 Testing of underground pipelines

- a. The installation to be tested shall be inspected for compliance with the drawings and specifications. Significant variations shall be investigated and corrected, if required, before proceedings with the test.
- b. After laying, jointing and anchoring, the underground pipeline shall be slowly and carefully filled with water so that all air is expelled and then tested under pressure depending on the material from which the pipeline is constructed. The system shall be tested to 1.5 times the maximum working pressure that the pipeline would be subjected to under normal operations. Long pipelines shall be tested in sections as the work proceeds.

- c. Final test shall be carried out only when all relevant work is complete.
- d. A higher test pressure shall be required in the case of any pumping main subject to surge, but at no more than 1.5 times the design pressure of the pipeline, for a maximum duration of one hour.

24.3.4.3.3 Testing of installations within buildings

The installation shall be filled slowly with drinking water to allow air to be expelled from the system. The complete installation shall be inspected for leaks. The installation shall be tested hydraulically by subjecting the pipes, pipe fittings and connected appliances to a test pressure of not less than 1.5 times the maximum working pressure, depending on the materials from which the pipeline is constructed. There shall be no visible leakage of water and the pressure shall be maintained for one hour.

24.3.4.3.4 Test Procedure for Rigid Pipes

The pipe work shall be vented, filled slowly with drinking water and subjected to the required test pressure. Where there are significant differences ($>10^{\circ}\text{C}$) between the ambient temperature and the water temperature, there is an initial period of 30 min before the commencement of the test period, to permit temperature equilibrium after the test pressure has been applied. There shall be no visible leakage of water and the pressure shall be maintained for a test period of one hour.

24.3.4.4 Test procedure for plastic pipes

The contractor shall use test procedure A or B for the pressure testing of plastic pipes.

24.3.4.4.1 Test procedure A

- a. Fill the system slowly with drinking water to allow air to be expelled from the system. Raise the pressure in the system to 100kPa. Inspect the complete installations for leaks at this pressure prior to subsequent hydraulic testing. Proceed if there is no visible leakage of water after 45 min.
- b. Test the installation hydraulically by subjecting the pipes, pipe fittings and connected appliances to a test pressure of not less than 1.5 times the maximum working pressure by pumping. Proceed if there is no visible leakage of water after 15 min at this pressure.
- c. Reduce the pressure in the pipe work by bleeding water from the system to one third of the previous test pressure. The test is passed if there is no visible leakage of water and the pressure is maintained for 45 minutes.

24.3.4.4.2 Test procedure B

- a. Fill the system slowly with drinking water to allow air to be expelled from the system. Apply the required test pressure by pumping and maintain by pumping for

a period of 30 min, and note the pressure in the pipeline at the end of the period. Inspect the pipe work to identify any visible leaks in the system. Continue the test without further pumping.

- b. Note the pressure after a further 30 min. If the pressure drop is less than 60 kPa (0.6 bar), the system can be considered to have no obvious leakage. Visually check for leakage and monitor for 120 min. The test criteria are met if the pressure drop in the system is less than 20 kPa (0.2 bar).

24.3.4.5 Pipe Line Disinfecting

24.3.4.5.1 General

The Contractor shall furnish all equipment, labour and material for the proper disinfection of the pipe line. Disinfection shall be accomplished by chlorination after the lines have been connected to the main system. Disinfection of the pipe lines shall be done in the presence of the Engineer's Representative with the equipment approved by him.

24.3.4.5.2 Chlorination

A mixture of chlorine and water shall be supplied by means of a solution feed chlorination device. The chlorine solution shall be applied at one end of the pipe line through a tap in such a manner that all air is expelled from the pipe line and it is filled with water. The dose applied in the water entering the pipe shall be at least 25 mg/l or enough to meet the requirements given hereinafter.

24.3.4.5.3 Retention Period

Chlorinated water shall be retained in the pipe line for a period of at least 24 hours. After the chlorine treated water has been retained for the required time, the chlorine residual at the pipe extremities and at such other representative points shall be at least 10 mg/l. This procedure shall be repeated until the required residual chlorine concentration is obtained.

24.3.4.5.4 Chlorination of Valves

During the process of chlorination of pipes lines, all valves and other appurtenances shall be operated while the pipe line is filled with the heavily chlorinated water.

24.3.4.5.5 Final Flushing

Following complete disinfection of the pipe line, all treated water shall be thoroughly flushed from the pipe line and its extremities. Treated water and water used for the flushing of pipe lines shall be disposed of in a manner instructed by the Engineer. Fresh treated water shall be filled in the pipe line and water tested for presence of coliform. The test result should indicate negative coliform presence. If the test indicates any

positive coliform, the entire process of disinfection shall be repeated until coliform free samples are obtained.

24.3.4.5.6 Sampling and Testing

Disinfection of pipe line and appurtenances shall be the responsibility of the Contractor. The first test of samples will be collected for analysis by the Engineer. Should the sample reveal presence of coliform, the Contractor shall again disinfect the pipe line and appurtenances and shall pay the Employer for sampling and testing for the subsequent re-test until coliform free samples are obtained.

24.3.4.5.7 Clean Up

Upon completion of the installation of the water supply lines and appurtenances, all debris and surplus materials resulting from the work shall be removed and disposed of in a manner satisfactory to the Engineer.

24.3.5 Material Requirements for Water Supply

Cast iron pipes, ductile cast iron pipes, galvanized iron pipes, mild steel pipes and UPVC pipes and their fittings are normally used for the transportation of water. Specifications and quality requirements of these materials are briefly described as under:

24.3.5.1 Cast Iron (grey iron) Pipes and Fittings

Cast Iron pipes are used for pressure mains and laterals where large quantities of water are to be carried. Due to their strength and corrosion resistance, cast iron pipes can be used in soils and for waters of slightly aggressive character. Due to their heavy weight, they pose transportation problems.

The specifications of Cast Iron pipes and their fittings are given at sub-section 14.1 of Book I.

The above specifications are however applicable to cast iron (grey iron) pipes and all special castings with sockets, spigots and flanges as defined therein. They are not applicable to the cast iron soil pipes and their specials used in the building industry.

24.3.5.2 Ductile Iron Pipes and Fittings

Ductile iron pipes and fittings shall comply with the requirements of BS 4772 and ISO Standard 2531. Pipes and fittings shall be coated internally with sulphate-resisting Portland Cement.

Ductile Iron Pipes are used for higher pressure mains for a working pressure of from 350 lbs. per square inch up to 450 lbs. per square inch. The metal is produced by inoculating molten iron of suitable composition with magnesium resulting in a metal structure in which the graphite formation is spheroidal, or nodular, rather than in the

form of graphite flakes obtained with the conventional grey irons. Ductile Iron for this reason is also known as 'spheroidal graphite iron' or nodular iron.

Due to the changed graphitic formation, the characteristics of ductile iron differ from those of grey iron, in that ductile iron possesses the properties of higher mechanical strength and ductility without losing the high resistance to corrosion and good casting qualities inherent in grey iron.

Ductile iron pipe can, therefore offer:

- high tensile strength and ductility;
- carry high working pressures;
- resist severe impact without damage;
- retain sufficient rigidity to carry external loading without serious distortion and can be produced with reduced thickness as compared with grey iron, resulting in reduced weight and increased carrying capacity; and offer resistance to corrosion equal to that of grey iron.

24.3.5.3 Galvanized Iron Pipes and Fittings

Galvanized Pipes shall be medium grade similar to BS 1387 stainless tube tested to a hydraulic pressure of not less than 50 kg/cm². The pipes shall be free from defects such as pinholes and leaks, galvanized internally and externally and obtained from an approved manufacturer, such as Karachi Pipe Mills or equivalent.

The specifications for these pipes and their fittings are given at Appendix 14-2 of Chapter 14.

24.3.5.4 Plastic Pipes and Fittings

24.3.5.4.1 Un-plasticized Polyvinyl Chloride (PVC-U) Pressure Pipes

Un-plasticized Polyvinyl Chloride is the rigid grade of Polyvinyl Chloride suitable for pipelines applications.

The pressure pipes shall, comply with BS 3505 and PS 3501. The fittings for these pressure pipes shall comply with BS 4346 These shall be made from material identical to that of the pipe and shall be capable of withstanding the same maximum sustained pressure as the pipe. Fittings shall be obtained from the same manufacturers as of the pipes to which they will be fitted.

The pressure pipes are classified as Class B (6 bar), Class C (9 bar), Class D (12 bar) and Class E (15 bar). For pressure pipe system these pipes are available in sizes varying from ¾", 1", 2", 3" up to 16". The Pipes and fittings 3 in. and larger sizes shall be Class C. The jointing comprises rubber ring or Z joint and solvent cement joint.

For tube well casing and screen pipes are available in diameter of 4" and 6" (Class D) and in diameters of 8" and 10" (Class C&D). The jointing comprises threaded sockets & solvent cement joint.

The pipes shall be entirely seamless and homogeneous, straight, true and concentric. The ends of the pipes shall be finished square to their axes and prepared externally for accurate jointing.

Pipes manufactured locally by DADEX Karachi or equivalent manufactured by other approved manufacturers shall be accepted for the works.

24.3.5.4.2 Un-plasticized PVC (UPVC) Pipes for Soil Waste & Vent Application

Un-plasticised Polyvinyl Chloride (PVC-U) pipes are also used for soil, waste and vent (SWV) system, these are being used in Pakistan for in-house and industrial discharge systems, due to its excellent physical and chemical properties and ease of installation.

The soil waste and vent pipes are classified as SWV pipe system and are available in diameters of 40mm, 50mm, 75mm, 110mm and 150mm. The jointing comprises rubber rings and solvent cement joint.

The soil waste and vent pipes shall conform to EN 1329 and ISO 3633. The fittings for soil waste and vent pipes shall conform to EN 1329 and ISO 3633. These are generally imported.

Pipes manufactured any approved manufacturer shall be accepted for the works.

The specifications of these pipes and their fittings are given at Chapter 14 of Book I.

24.3.5.4.3 Polypropylene Random (PPR) Pipes

Polypropylene Random (PPR) is a 100% certified food grade material. Its resistance to high temperature has made PPR a popular piping system recommended for hot and cold water installations in the domestic and industrial usage.

The physical and chemical properties of PPR make it a superior and safe piping system for transportation of potable water as well as aggressive fluids.

These pipes conform to DIN 8077 and DIN 8078 and pressure of PN 20. The fittings conform to DIN 16962 with pressure as PN 25

The pipes are available with nominal outside diameters of 20mm, 25mm, 32mm, 40mm, 50mm, 63mm, 75mm, 90mm and 110mm. The jointing of pipes is done by Heat Fusion Method.

These pipes are manufactured by Dadex under brand name of Polydex and are green in colour.

The specifications of these pipes and their fittings are given at Chapter 14 of Book I.

24.3.5.5 Valves

24.3.5.5.1 General

1. All valves shall open by counter clockwise rotation of the valve stem. Unless otherwise indicated in Specifications or on the Drawings, all valves shall be flanged. Stuffing boxes shall be bolted and constructed so as to permit the easy removal of parts for repairs. Buried Section of valves shall have same external protection as the underground pipework with which they are to be used.
2. General specifications for the procurement of sluice and other valves are given in Section 20.7.21 of the next Chapter.

24.3.5.5.2 Sluice valve or Gate Valve

1. Sluice or gate valves are used to regulate the flow of water through the pipes. In large pipe lines, bringing water from source to the city, they are generally located along the pipe line at intervals of 3 to 4 kilometres, so as to divide the pipe line in to different sections. Thus during repairs, only one section can be cut off at a time by closing the gate valves at both ends of that section.
2. The gate valves are usually placed at summits of the pressure conduits, because when so placed they can of relatively cheaper and less stronger materials and also can be operated easily with lesser force.
3. Valves shall be wedge gate valves/check valves confirming to BS 5163. Ends of valves shall be suitable for the type of pipe to which the valves will be commented. The direction of flow shall be marked by arrow on the body of the valve.
4. The valves shall be provided with extension spindles and surface boxes. The extension spindle shall be suitable for a covering depth of up to 1 m. The covering depth is to be read as the distance between the internal pipe top and ground level. The gearing and operating mechanism of all valves shall be fully enclosed.
5. All valves installed above ground shall be provided with a locking device and an operating hand wheel, all included in the unit price of the valve. All pipeline valves installed below ground shall be provided with wrench nuts of standard square head size such that one T-handle key can operate all valves. The Contractor shall provide T-handle keys matching the standard wrench nut.

24.3.5.5.3 Air Valve or Air Relief Valve

These shall be designed to meet the following conditions:

- Expulsion of air during charging of the pipeline
- Admit air during emptying of the pipeline to avoid the occurrence of negative pressure

- Expulsion of air accumulated at summit points along the pipe line under normal operating condition

Air valves shall be fixed on trunk and secondary mains at the highest points, on undulating water mains, on long stretches of nearly level mains, and at summits of all changes of gradient.

The nominal pressure shall be NP-10 for air valves on potable water lines and NP -16 for air valves on fire water lines.

Both double or single orifice air valves shall be used as per requirement. In double orifice valves, the large orifice shall be sealed by a buoyant rigid ball and the chamber housing shall be designed to avoid premature closing of the valve by the air, whilst being discharged. The small orifice shall be sealed by a buoyant ball at all pressures above atmospheric except when air accumulates in the valve chamber. Body ends shall be flanged with raised faces and drilled according to BS 10 for the nominal pressure specified or indicated in the drawings

The materials for the valves shall be, cast iron boy cover and bowl for small orifice, cast iron with gunmetal seat with rubber covered ball or other approved, for large orifice, cast iron with rubber seat and vulcanite covered ball or other approved

24.3.5.5.4 Scour Valve or Blow off valve or Drain Valve

1. These are small gate valves in pressure conduits, which are provided at the bottom of all depressions and dead ends to drain out the waste water or sediment collected. The exact location of scour valve is frequently influenced by appurtenances to dispose off the water. Scour valves are usually 80 to 150mm diameter leading from the main from a flanged tee branch to a ditch with sluice valve control. A combined stop cock and scour valve is frequently used for buildings.
2. When opened, water comes out of these valves quickly under gravity and they are made to discharge water in to some natural drainage channel or into a sump from where the water could be pumped out. In this context it is necessary that there should not be any direct connection between the valve and the sewer or drain so as to avoid the possibility of pollution traveling back to the water pipe line. For safety, two drain valves are generally provided in series, so as to reduce the chances of such pollution reaching the water in the conduit.

24.3.5.5.5 Pressure Relief or Safety Valve

1. These are fixed at the downstream ends of long length of mains or where water hammer is likely to occur, to relieve excessive pressure. These are automatic valves that close when pressure becomes excessive on downstream side. They are heavily weighted spring controlled valves which open under pressure exceeding those for which they are set.

2. They are best connected to the mains with flanged joints so that they can be easily removed, repaired and re-inserted without disturbing the rest of the pipe line.

24.3.5.5.6 Check Valve or Reflux Valve or Non-Return Valve

1. Check valves are sometimes called non-return valves because they prevent water to flow back in the opposite direction. They may be installed on the delivery side of the pumping set, so as to prevent the stored or pumped water, when the pump is stopped. Check valves are also installed on pump discharges to reduce water hammer forces on the pump.
2. Check valves are also required at inter connections between a polluted water system and potable water system, so as to prevent the entry of polluted water in to potable water.
3. A check valve installed at the end of a suction line is called foot valve, which prevents draining out of the suction line when the pump stops. Check valves shall comply with the requirement of BS 5153 or equivalent. The valve shall be of swing type and shall be quick acting single door type.

24.3.5.6 Fire Hydrant

1. A fire hydrant is fixed in water supply distribution lines in populated areas for use of firefighting equipment. It consists of a cast iron barrel with a bell or flange fitting at the bottom to connect to a branch from the water main, a valve of the gate or compression type, a long wall stem terminating in a nut above the barrel and one or more outlets.
2. Fire hydrant shall conform to BS 750 (Type-2) and shall be of screw down streamline pattern.
3. The body shall be best quality, closed grain, grey cast iron with spindle of manganese bronze having tensile strength of not less than 11 t per sq.in . The seating valves and other parts shall be of best quality gun metal with brinell hardness No. 80. The direction of closing shall be clockwise rotation and out shall have fire hose threads for accommodation of 2-1/2" dia hose connection. Inlet flanges of hydrant shall be suitable for jointing with flanges of hydrant bends and tees. All fire hydrants shall be coated with one coat of primer and two of signal red enamel paint of approved manufacturer to give a uniform protective coating of cast iron.
4. The fire hydrant shall be supplied and erected complete with take-off from the main line pipe and an isolating gate valve. Fire hydrant outlets and isolating gate valve shall operate with one and the same key.

24.3.5.7 External Fittings

Bends, elbows collars, split collars, tees, tapers, angle branches, crosses, tail pieces and caps are used in laying water supply distribution system to complete the grid and facilitate the fixing of valves and fire hydrants etc.

24.3.5.8 Service Meter

A Service Meter is used for measuring the consumption of liquid or gas supply. In water supply system, the common type of meter used is called service meter.

24.3.5.9 Internal Fittings

Internal fittings, taps, valves and cocks are termed as internal fittings. These are fixed to control and regulate the flow of liquid or gases. Cocks are commonly screwed down valves. These are fitted with internal plug, a quarter turn of which closes the line. These are usually used to control domestic water supply and gas lines at outlet points, on coolers and for emptying holders.

Following are the different types of taps, valves or cocks commonly used.

24.3.5.10 Bib tap

Bib tap is a draw off tap with a horizontal inlet and free outlet. It is used over sinks to fill cistern or buckets and hospital baths. The common sizes are $\frac{1}{4}$ ", $\frac{3}{8}$ ", $\frac{1}{2}$ ", $\frac{3}{4}$ ", 1" $1\frac{1}{4}$ ", $1\frac{1}{2}$ " and 2" The inlet is kept horizontal and is always fitted with a tail having external paralleled thread.

24.3.5.11 Hose tap

Hose tap is a bib tap with a screw or union on the outlet for the attachment of a flexible pipe.

24.3.5.12 Pillar tap

Pillar tap is a draw off tap with a vertical inlet and a horizontal outlet, the nose of which is kept down to give a vertical discharge. The flanges on the base of the body rest on the top of a bath roll or lavatory shelf and beneath it is a square section fitting the tap holes. From the square portion there is a tail 2" long screwed with a parallel thread riding on which is a backnut for tightening to the ware. The common sizes are $1\frac{1}{2}$ ", $\frac{3}{4}$ ", and 1".

24.3.5.13 Globe tap

Globe tap is a draw off tap with a horizontal inlet and vertical free outlet. It is used in baths or similar apparatus, It is made in sizes $\frac{1}{2}$ ", $\frac{3}{4}$ " and 1". The inlet has internal thread usually connected to a bent tail pipe which passes through and should have a union below the tap hole.

24.3.5.14 Screw down tap or stop valve

Screw down tap or stop valve is a tap or stop valve closed by means of a disc carrying a renewable non-metallic washer which shuts against the water pressure on a seating at right-angles to the axis of the screwed spindle which operates it.

24.3.5.15 Self-closing taps

Self-closing taps are used in factories and schools to avoid waste of water and are fixed vertically or horizontally. These are made in such a manner as when the button head is pressed the water flows and when the hand is removed the spring control causes the head to rise and the water is shut off. These taps are used for low pressure service only except where desired.

24.3.5.16 Stop valve

Stop valve is a valve with suitable means of connection for inertial free outlet. The common sizes are $\frac{1}{4}$ ", $\frac{3}{8}$ ", $\frac{1}{2}$ ", $\frac{7}{8}$ ", $\frac{3}{4}$ ", 1", $1\frac{1}{4}$ ", $1\frac{1}{2}$ " and 2". They are intended for the isolation of pipe lines and individual service connections to sink lavatories, bath and W. C. cisterns and they facilitate repair and replacement of washers. Its tail is made for lead pipe connection with external parallel threads or with one and having external threads and the other having internal thread as desired.

For the specifications of taps, stop cocks, floor traps and gully traps please refer to Sections 20.7.18, 20.7.19 and 20.7.20 of the next Chapter.

24.3.6 Construction Requirements for water supply

24.3.6.1 Excavation, Trenching and Backfilling for Water Supply Pipes

The excavation, trenching and back filling for water supply pipes should conform to the specifications given in the relevant section of Chapter 3 – "Earth Works" of Book II, Part 1 of these Specifications.

24.3.6.2 Installation of Pressure Piping System

Each pipe shall be inspected before being installed. All lumps, blisters and foreign materials shall be removed from the pipes, and the joints shall be brushed clean. Any pipe unit or fitting discovered to be defective either before or after installation shall be removed and replaced with a sound unit. Except as otherwise indicated on the drawings, the pipe shall be supported over its entire length. No pipe or fitting shall be permanently supported on saddles, blocking or stones. All pipe and fittings shall be cleared of all debris, dirt, etc., before being installed and shall be kept clean until accepted in the completed work.

Pipe and fittings shall be installed to the lines and grades indicated on the drawings or as required by the Engineer. Care shall be taken to ensure true alignments and

gradients, and any deviations from the drawing or noticed after completion of the work shall be corrected by the Contractor at his own responsibility and cost.

Before any joint is made, the previously-installed unit shall be checked to assure that a close joint with the adjoining unit has been maintained and that the inverts are matched and conform to the required grade. The pipe shall not be driven down to the required grade by striking it with a shovel handle, timber or other unyielding object.

All joint surfaces shall be cleaned immediately before jointing the pipe; the machined end shall be lubricated in accordance with the manufacturer's recommendations. Each pipe unit shall then be carefully pushed into place without damage to pipe or gasket. Suitable devices, as recommended by the manufacturer, shall be used to force the pipe units together so that they will fit properly according to the manufacturer's recommendations, leaving a recess of about 8 mm for free expansion of pipe, and having tightly-sealed joints. Care shall be taken not to use such force as to split or otherwise damage the coupling or machined ends.

Immediately after the pipe joint is completed, the position of the gasket in the joint shall be inspected to be sure it is properly put together and is right. Joints in which the gasket is damaged or not properly positioned shall be pulled apart and re-made using a new gasket. Where any two pipe units do not fit each other closely enough to enable them to be properly jointed, they shall be removed and replaced with suitable units and gaskets.

Details of gasket installation and joint assembly shall follow the directions of the manufacturers of the joint material and of the pipe, all subject to the approval of the Engineer. The resulting joints shall be watertight and flexible.

Open ends of pipe and branches shall be closed with watertight plugs or stoppers secured in place in a satisfactory manner, subject to the approval of the Engineer.

For trench installation, after each pipe has been properly bedded, enough screened sand shall be placed between the pipe and the sides of the trench and thoroughly compacted to hold the pipe in correct alignment. Coupling holes, provided for jointing, shall be filled with screened sand and compacted and then screened sand shall be placed and compacted to complete the pipe bedding as indicated on the drawings and as specified above. The Contractor shall take every precaution to prevent flotation of the pipe in the trench.

At all times when pipe installation is not in progress, the open ends of the pipe shall be closed with temporary watertight plugs or by other approved means. If water is in the trench when work is to be resumed, the plug shall not be removed until all suitable provisions have been made to prevent the water, earth or other material from entering the pipe. Pipelines shall not be used as means for transportation of trench drainage during construction.

After laying the pipe, it shall be visually inspected by the Engineer and then secured in position for pressure testing as described. Immediately after passing the pressure test, each section of pipeline tested shall be backfilled.

24.3.6.3 Handling & Storage of Pipes

24.3.6.3.1 Pipes in General

The recommendations of the manufacturers must be obtained for safeguards to be applied in transporting, handling, stacking, storing and installation of pipes and fittings. Such recommendations must be followed but, nevertheless, the Contractor is required to ensure that further safeguards are applied if necessary because of the site and climatic conditions. All damaged or distorted pipes and fittings shall be rejected by the Engineer and replaced at the Contractor's expense.

- a. Pipe and accessories shall be handled in such a manner as to ensure their delivery to the trench in 'sound and un-damaged manner. If any pipe or fitting is damaged, the replacement shall be made by the Contractor at his expense.
- b. No other pipe or material of any kind shall be placed inside of a pipe or fittings. Pipe shall be carried into the position and not dragged.
- c. The interior of the pipe and accessories shall be thoroughly cleaned before lowering into the trench and shall be kept clean during laying operations by plugging or other approved method.
- d. Before installation, the pipe shall be inspected for defects. Material found to be defective before or after laying shall be replaced with sound material without additional expense to the Employer.
- e. Rubber gaskets those are not to be installed immediately shall be stored in a cool dark place and protected against the direct rays of the sun.

24.3.6.3.2 Plastic Pipes

Pipes should be stacked on a flat base or level ground or alternatively on timber bearers at spacing not greater than 1.5m while the width of the bottom layer of the stack should not exceed 3 m. Pipe should be stacked not more than 1 m high.

- a. Pipe stacks should contain one diameter size only. If this is not possible then the largest diameter should be stacked at the bottom. Small pipes may be nested inside larger pipes. If pipes are transported one inside the other, the inner pipes should always be removed first.
- b. When stored in the open for long periods or exposed to strong sunlight the stack should be shielded with an opaque material.
- c. Fittings should be stored under cover and kept in their cartons or packing until

required.

- d. Solvent cement solution and cleaning fluid should be stored in a cool dry place, out of direct sunlight and away from any heat source.

24.3.6.4 *Cutting of Pipes*

The pipes shall be cut in a neat workmanship like manner without damage to it. Unless otherwise authorized by the Engineer or recommended by the manufacturer, cutting shall be done with a mechanical cutter of approved type. Wheel cutters shall be used wherever practicable.

24.3.6.5 *Maximum Allowable Deflection*

Maximum allowable deflections from a straight line or grade, as required by the vertical curves, horizontal curves, or offsets, will be 5 degrees from the pipes unless otherwise recommended by the manufacturer.

If the alignment requires deflections in excess of the specified limitations, special bends or shorter lengths of pipe shall be furnished to provide angular deflections within the limit set forth, as approved. Long radius curves in pre-stressed concrete pipes shall be formed by straight pipe in which spigot rings are placed on a bevel.

24.3.6.6 *Laying of Pipes*

Pipes shall be laid to ensure even support throughout their length and shall not rest on their sockets or on bricks, tiles or other makeshift supports. Plastics pipes shall be laid in accordance with CP 312 (all parts) on a bed free from sharp stones.

Pipes in all cases shall be provided with protection from damage by frost, excessive heat, traffic loads, vibration and contamination, or from any other cause.

The normal minimum cover for protecting underground pipe work against frost damage shall be achieved by laying pipe work at a depth of at least 0.75 m but not greater than 1.35 m.

Considerations shall be given to the possibility of future contamination from hydrocarbons (petrol/ diesel/ heating oil) or from any other possible contaminants through permeation.

Where possible pipes shall be laid in continuous lengths avoiding unnecessary joints.

24.3.6.7 *Trench excavations*

The bottom of trench excavations shall be carefully prepared to a firm even surface so that the barrels of the pipes when laid are well bedded for their whole length. Mud, rock projections, boulders, hard spots and local soft spots shall be removed and replaced with selected fill material consolidated to the required level.

Where rock is encountered, the trench shall be cut at least 150 mm deeper than other ground and made up with well-rammed material.

24.3.6.8 *Trench backfilling*

When backfilling trenches, the pipes shall be surrounded with suitable material consolidated to resist subsequent movement of the pipes. No large stones or sharp objects shall be in contact with the pipes.

24.3.6.9 *Ingress of dirt*

Pipes shall be thoroughly cleaned internally before laying and the open ends shall be temporarily capped until jointing takes place. Care shall be taken to keep the joint surfaces clean.

24.3.6.10 *Hydrocarbon permeation risk*

Water fittings laid in ground subject to spillage of hydrocarbons such as oil, petrol shall be resistant to and/or protected from deterioration by exposure to such contaminants.

24.3.6.11 *Protective coating*

Coatings, sheathing or wrapping shall be examined for damage, repaired where necessary before trench excavations are backfilled.

24.3.6.12 *Laying of Pipes Attached to Walls and Ceiling & Sleeve Pipes*

Every pipeline attached to walls, floors, roofs or ceilings shall be supported by galvanized holder bats placed securely into the walls, floors roofs and ceiling at intervals not exceeding 8 feet throughout its length clear of the walls, floors, roofs or ceilings as the case may be as shall be fixed in writing by the Engineer for each particular case in order to facilitate perpendicular painting, coating or if necessary, provision of lagging materials thereto.

Every pipeline laid through any walls, floors, ceilings or roofs shall be arranged to pass through sleeve pipes of ample diameter embedded therein to enable the pipeline to pass easily and freely therein. The length of every such sleeve pipe shall be of the full width or thickness of the wall and in the case of a roof, ceiling or floor shall be at least 1-1/2" longer than the thickness thereof and shall project to that extent above the upper surface thereof unless the Engineer orders to the contrary. Every sleeve pipe shall consist of a single length of British Standard water quality wrought iron or steel pipe or otherwise of a steel or wrought iron pipe not less than 1/4" thick to the approval of the Engineer.

24.3.6.13 *Concealed/Open Installation of Plastic Pipes*

24.3.6.13.1 *Concealed Installations*

The Plastic pipes do not cause any problem when embedded in the wall or floor, because naturally occurring frictional forces prevent the thermal expansion and contraction. Also the characteristic of deformability of the system can absorb expansions in walled installation.

24.3.6.13.2 *Fastening technique for open installation*

Suspended pipelines require compensation for thermal changes and this can be achieved by proper placement of fixed and sliding clamps in the installation network.

24.3.6.14 *Fixed Point*

Fixed clamps help limit the uncontrollable movements of the pipelines and divide them into sections. Fixed point spacing must be performed on the basis of pipe diameter. The material used to perform this operation must possess certain characteristics so that it does not damage the external surface of the pipe.

24.3.6.15 *Sliding Point*

Sliding clamps allow the axial movement of the pipe without damaging it. On locating a sliding clamp it has to be ensured that movements of the pipeline are not hindered by fittings or armatures installed next to them.

Table 24-2: Recommended Clamping Distance

Mm	20°C	30°C	40°C	50°C	60°C	70°C	80°C
20	120	115	109	105	104	100	95
25	140	130	125	121	118	112	108
32	160	158	154	150	145	140	135
40	185	175	168	164	160	155	150
50	200	178	185	175	170	165	155
63	210	205	195	187	180	175	165
75	230	225	215	195	182	180	170

24.3.6.16 *Jointing of Pipes-General*

All joints shall be made in accordance with the manufacturer's instructions. When making joints by welding, brazing or soldering, precautions shall be taken to avoid the risk of fire and care taken to avoid inhalation of fumes from the jointing process. Connection between different types of pipes and accessories shall be made with transition fittings where recommended by the pipe manufacturer.

Ends shall be cut square, all burrs shall be removed from the ends of pipes and any jointing materials used shall be prevented from entering the system. All piping and

fitting shall be cleaned internally and shall be free from debris.

No metal pipe shall be connected to any other pipe or water fitting by means of an adhesive in any case where the metal pipe is:

- Installed in the ground or passes through or under any wall footing or foundation
- Embedded in a wall or solid floor
- Enclosed in a chase or duct
- In a position where access is difficult

New and modified water systems shall be flushed before use. Cutting tools that are in good condition shall be used to limit tube distortion and the tube should be cut square with the axis.

Any tube ends that are distorted shall be re-rounded using a suitable tool prior to the joint assembly.

24.3.6.17 Jointing of C.I. Pipes

24.3.6.18 Spigot and Socket Joints

These joints are preferred over flanged joints for C.I. pipes due to their flexible nature. To make this joint, spigot end of the next pipe is inserted in socket of first pipe. The socket end of pipe is kept against the flow of water. In case of slopes, the socket end shall face upstream.

- a. The spigot and socket joints of the pipes and special castings shall be made with lead and best white Pakistani spun yarn. The joints shall be made by forcing the spigot end of one pipe into the socket end of the preceding one. A gasket of spun yarn is then driven and caulked into the bottom of the joint to keep the pipes concentric. The gasket shall either be driven in complete rings or the length of yarn to form each ring being carefully measured and cut before hand to ensure a good fit or, better still a spiral coil of yarn shall be inserted. In the former case, care shall be taken that the joints of the successive rings do not coincide. Each ring shall be packed with a thin steel "yarning" tool and then lightly hand caulked to ensure that the yarn is solidly packed. No short pieces of yarn forming less than a complete ring shall be used.
- b. The yarn shall be caulked to such a depth as to leave clear the following depths measured from the faces of the sockets given in the table below for the lead joints.

Table 24-3: Depth of Lead Joints

I/d of pipe	Finished depth of lead joints	I/d of pipe	Finished depth of lead joints
2"	1-5/8"	7"	1-3/4"

2-1/2"	1-5/8"	8"	1-7/8"
3"	1-5/8"	9"	1-7/8"
4"	1-5/8"	10"	2"
5"	1-5/8"	12"	2"
6"	1-3/4"		

24.3.6.19 Leading of Joint

- a. The lead for the joint shall be melted in a suitable lead pot in a special grate or "devil" or over a furnace provided close to the joint. The outer end of the socket shall then be closed either by means of a thoroughly kneaded clay gasket stiffened with a core of yarn in the case of small pipes, or by a hinged iron ring or by a clip or asbestos composition ring fitted over the spigot against the face of the socket and pulled up tight by a thumb screw at the top of the pipe, a small "pond" about 5 or 6 square inches in area by about 1 inch in depth being formed in the clay at the summit of the pipe with an outlet into the top of the joint.
- b. The molten lead shall then be run into the joint either from a metal ladle or directly from the lead pot to completely fill up the joint in one operation. Care shall be taken to have sufficient molten lead in the pot for each joint before starting the operation. All partially filled joints shall be cut or melted out and the whole joints shall be refilled completely with lead at one running. To ensure that the joint is completely filled with lead the "pond" at the summit of the pipe shall be kept filled to the brim in the course of pouring the molten lead.
- c. The internal surface of the clay gasket or metal or asbestos ring shall be levelled off to leave a uniform fill of lead projecting on the face of the socket all round to the extent of not less than 1/4 inch.
- d. Before making any joint, care shall be taken, to remove all thick bituminous material or coal-tar from the spigot and from the inside of the socket. Both shall be thoroughly cleaned and dried before the joint is made.
- e. The weight of C.I. pipes of Class 'B' and that of weight of the lead required for jointing are given approximately in the table given below:

Table 24-4: Dimensions of CI pipes Class B

Diameter of Pipes (in)	Length of Pipe (ft)	Thick-ness of Pipes (in)	Weight of Each Pipe (lb)	Total Depth of Socket (in)	Weight of Lead per joint (lb)	Weight of Hemp per Joints (lb)	Depth of Lead (in)
------------------------	---------------------	--------------------------	--------------------------	----------------------------	-------------------------------	--------------------------------	--------------------

1	2	3	4	5	6	7	8
3"	9'	0.38	129	3	4.5	0.25	2.00
4"	9'	0.39	172	3	5.5	0.38	2.00
5"	9'	0.41	228	3½	7.0	0.44	2.50
6"	9'	0.73	286	3½	8.0	0.44	2.40
7"	9'	0.45	345	3½	9.5	0.50	2.40
8"	9'	0.47	416	4	12.0	0.63	2.90
9"	9'	0.49	485	4	13.5	0.69	2.90
10"	12'	0.52	730	4	14.75	0.75	2.90
12"	12'	0.57	930	4	17.0	1.06	2.90
14"	12'	0.61	1163	4½	21.5	1.38	3.25
15"	12'	0.63	1281	4½	23.0	1.50	3.25
16"	12'	0.65	1407	4½	24.25	1.63	3.25
18"	12'	0.69	1685	4½	31.50	2.07	3.10

24.3.6.20 Caulking of Joints

- a. After the lead has solidified in the joint the clay gasket or the ring shall be removed and the joint caulked by hammering up the face of the lead uniformly with a series of at least three special caulking chisels, the thicknesses of the caulking edges of which shall vary from a little less than 1/8" to just under. The width of the lead joint shall be set back by caulking, not less than 1/6th of an inch inside the face of pipe socket.
- b. Each caulking chisel shall be kept perfectly true on the edges and the surface of the working face shall be formed at an angle of about 80° to 85° to the back of the tool.
- c. The finished face of each lead joint shall be smooth and uniform all round and shall not show any tool marks. The caulking hammer shall be of steel with hexagonal or octagonal face, weighing 12 lbs. with short wooden handle.

24.3.6.21 Flanged Joints for C.I. Pipes

- a. Flanged joints are also used with C.I. pipes. These shall be made using 1/8" rubber insertion discs accurately cut. The bolts of the joints are to be tightened up systematically and uniformly in such a manner that the tension in all the bolts shall

be similar and there shall be no tendency to distortion.

- b. No bolt shall be stressed beyond its elastic limit and no spanners other than British Standard pattern shall be allowed nor shall any appliance for lengthening the leverage of any spanner be permitted.
- c. All flanges with their bolts shall be painted with 2 coats of paint or tar before the earth filling is done

24.3.6.22 Jointing of G.I. Pipes

- a. The galvanized iron pipes shall strictly conform to BS 1387 (EN 10255) and shall be of medium grade. All screwed pipes and sockets shall conform BS EN 10241. A complete and uniform adherent coating of zinc white will be provided for galvanized iron pipes and fittings.
- b. All screwed tubes and sockets shall have BS pipes thread in accordance with BS EN 10226. In order to prevent damage to the leading thread, the ends of the sockets shall be chamfered internally.
- c. Depending upon the size of pipe, the number of threads in 25.4mm length, pitch, depth of thread, gauge length etc. are tabulated below:

Table 24-5: Number of threads in 25.4mm length, pitch, depth of thread, gauge length

Nominal size of pipe (internal) diameter (mm)	Minimum Length of threaded end of pipe (mm)	Number of threads in 25.4 mm length	Minimum number of threads in threaded length given in col. (2)	Depth of thread (mm)	Gauge length (mm)
(1)	(2)	(3)	(4)	(5)	(6)
15	19 mm	14	11	1.162	8.2
20	20 mm	14	11	1.162	9.5
25	23 mm	11	10	1.479	10.4
40	26 mm	11	12	1.479	12.7
50	30 mm	11	13	1.479	15.9
100	44 mm	11	19	1.479	25.4

*Gauge length can be taken as length of taper portion of threaded end. This taper is 1 in 16.

- a. Tubes which are bundled shall be secured together by rope or soft iron or other suitable material.
- b. The threads of all tubes shall be effectively covered with good quality grease or

other suitable compound, and each tube above 50 mm nominal bore shall have a protecting ring affixed to the un-socket screwed end.

- c. All pipe fittings up to 75 mm dia. shall conform to BS EN 10226 and shall be of malleable cast iron. Pipe fittings above 75 mm dia. shall be of approved material and specifications as decided by the Engineer.
- d. A complete and uniform adherent coating of zinc will be provided for galvanized pipes.
- e. Tubes which are bundled shall be secured together by rope or soft iron or other suitable material.
- f. The threads of all tubes shall be effectively covered with good quality grease or other suitable compound, and each tube above 50 mm nominal bore shall have a protecting ring affixed to the un-socket screwed end.
- g. All pipe fittings up to 75 mm dia. shall conform to BS EN 10226 and shall be of malleable cast iron. Pipe fittings above 75 mm dia. shall be of approved material and specifications as decided by the Engineer.

24.3.6.23 Jointing of Mild Steel (M.S) Pipes

- a. The water supply pipes shall conform to API 5L wall B Standard ERW Sch. 40.
- b. M.S. short pieces shall be flanged at both ends. The flanges shall conform to BS EN 1092-1. M.S. pipe pieces shall be externally protected by applying two coats of red oxides (of approved quality) and bituminous coating (grade 10/20) at the rate of 0.4 lb/sq.ft.

24.3.6.24 Jointing of Plastic Pipes

24.3.6.24.1 Un-plasticized PVC (UPVC) Pressure Pipes

- a. Mechanical joints
 - Mechanical joints in un-plasticized PVC piping of nominal diameter DN 2 and upwards shall be made in accordance with BS EN 1452-3, by the use of push-fit integral elastomeric sealing rings which are compressed when the plain ended pipes are inserted into the adjoining sockets. The plain pipe ends shall be chamfered and the surfaces cleaned and lubricated.
 - The chamfered pipe end shall be inserted fully into the adjoining socket (except where provision is to be made for expansion) or as far as any locating mark put on the spigot end by the manufacturer. The sealing rings shall conform to BS EN 681-1.
- b. Solvent cement joints

5. Solvent cement joints in un-plasticized PVC piping shall be made using a solvent cement conforming to BS 4346-3 recommended by the manufacturer of the pipe.
- c. Flanged joints
6. Flanged joints used for connections to valves and fittings shall use full-face flanges or stub-flange, both with corrosion resistant or immune backing rings and bolting and where appropriate wrap the joint with an approved protective material.

24.3.6.2.4.2 *Un-plasticized PVC (UPVC) Pipes for Soil Waste & Vent Application*

- a. Solvent Cement Jointing
 7. For jointing pipe to pipe or pipe to fitting with solvent cement, both the parts that are to be jointed must be dry and clean. Chamfer the pipe end and remove any dust or grease from both sides. Apply solvent cement using a paint brush on both the outside of spigot end and the inside of the socket, then insert the spigot end fully into the socket.
 8. Prior to insertion, mark the position of the socket edge with a pencil or felt tip pen on the pipe.
 9. Remove excess solvent cement with dry cloth. The joint may be handled after few minutes and can be tested/ commissioned after 24 hours.
- b. Rubber Ring Push Fit Jointing
 - i. Clean the pipe's spigot end from the outside and the sealing groove of the fitting from inside.
 - ii. Insert rubber ring into the socket end of the pipe/fitting. To avoid dislocation during/ after jointing (pipe to fitting or pipe to pipe) always ensure that the rubber ring is fixed in the right direction.
 - iii. Apply the lubricant (soap solution) uniformly to the spigot end and sealing ring and push the spigot end into the socket containing sealing ring until fully home.
 - iv. Prior to insertion, mark the position of the socket edge with a pencil or felt-tip pen on the pipe and withdraw the pipe from a socket by approximately 10mm to allow for thermal expansion.

24.3.6.2.4.3 *Jointing of Polypropylene Random (PPR) Pipes*

- a. The jointing of Polypropylene Random pipes is carried out by a method called "heat fusion". This is done by means of a welding machine. The male and female parts of pipes and fittings are joined together to form a joint.
- b. The ends of the two parts are heated simultaneously. Once the welding temperature (see table below) is reached, the two end parts (which are in molten form) are pressed together. They are held together till the recommended cooling time. When fully cooled, a permanent leak free joint is formed. Heat fusion is an

irreversible process, hence care should be taken in jointing in order to avoid loss of fittings

24.3.6.25 Welding Process

- Cut the pipe at the right angle with a cutter
- Mark off the welding depth at the pipe end
- Simultaneously heat the pipe ends of both pipe and fittings as per recommended heating time (see table above).
- Push the pipe end in to the fitting and ensure its alignment of assembly with in the specified time period

24.3.6.26 Welding Guidelines

- Always ensure that the welding machine corresponds to the required jointing time.
- Required operating temperature of the welding machine is approximately 260 °C.
- Cut the pipe at right angles by using a cutter.
- Always clean the pipe from burrs, cuttings and chips.
- Remember to mark the welding depths at the end of the pipe before heating.
- Push the end of the pipe in to welding machine up to the marked welding depth and push the fitting in to the welding machine simultaneously.
- Quickly remove the pipe and fitting from the welding machine on completion of the recommended heating time. Continue to press the pipe in to the fitting until the welding depth mark is covered with the bead of the material from the fittings.
- Allow the joint to cool down as per specified cooling time before starting installation.

Estimated Diameter (mm)	Welding Depth (mm)	Heating Time (sec)	Welding Time (Sec)	Cooling Time (min)
20	14.0	7	4	2
25	16.0	7	4	2
32	18.0	8	6	4
40	20.0	12	6	4
50	23.0	18	6	4
63	27.0	24	8	6
75	31.0	30	10	8
90	35.0	40	10	8

100	41.0	50	10	10
-----	------	----	----	----

- Mechanical and compression sleeve joints shall be installed in accordance with manufacturer's instructions.

24.3.6.27 Reaction Backing / Thrust Blocks

- The specials, bends, crosses, tees etc. shall be properly fixed and secured in the trench with concrete reaction backings/thrust blocks so that no risk of movement thereof shall take place due to the thrust of the water. Backing shall be placed between solid ground and the fitting to be anchored. For this purpose a block of cement concrete (1:3:6) length about 2 feet, depth equal to the diameter of the pipe and width being that of the excavation.
- Care shall be taken to ensure that each lead joint or flanged joint is fully exposed so that it can be caulked or re-caulked easily without interference due to the concrete blocks.

24.3.6.28 Setting of Fire Hydrants, Valves and Specials

- Fire hydrants, valves and specials shall be installed at locations as shown on the plans. The installation of these specials shall be in accordance with the recommendations of the manufacturers and as approved by the Engineer.
- All specials shall be installed in chambers constructed as per details shown on the plans. The backfill around the specials shall be thoroughly compacted to the finished grade lines immediately after installation, to obtain beneficial use of these specials as soon as practicable.
- The specials shall be installed as directed and shall be set plumb. The specials shall have the interiors cleaned of all foreign matter before installation.
- All sluice valves, air valves, hydrants and vertical branches shall be fixed perfectly vertical in all cases. All horizontal branches and trees shall be fixed perfectly horizontal.

24.3.6.29 Provision of Valve Chambers and Surface Boxes

- Surface boxes shall be provided to give access to operate valves and hydrants, and shall be supported on concrete or brickwork which shall not be allowed to rest on the pipes and transmits loads to them.
- Alternatively, vertical guard pipes or precast concrete sections shall be provided to enclose the spindles of valves. Brick or concrete hydrant chambers shall be constructed of sufficient dimensions to permit repairs.

24.3.6.30 Branch connections for buildings

24.3.6.30.1 Contamination

- a. Precautions shall be made to avoid contamination of the supply pipe when making a connection.
- b. No pipe shall be laid or installed near a sanitary manhole, cesspool, septic tank, soak away or other feature likely to cause the water to become contaminated or cause deterioration to the pipe material.
- c. Any pipe that crosses over a sewer shall be laid so that there is at least 600 mm clearance between the pipe barrels. Plumbing pipes shall not be laid below sewers.

24.3.6.31 Building entry

- a. Underground pipes entering a building shall do so at the level 0.75m below the ground.
- b. Where a pipe enters a building it shall be accommodated in a sleeve that has previously been solidly built in and the space between the pipe and the sleeve shall be filled with non-hardening, non-cracking, water-resistant material for a minimum length of 150mm at both ends to prevent the passage of water, gas or insects.

24.3.6.32 Pipe work under Buildings

- a. Where a pipe has less than 300 mm of cover under a load bearing slab, it shall be surrounded with concrete as an integral part of the slab. Where possible, the concrete shall be poured at the same time as the slab. The surround shall be tied to the slab with nominal steel reinforcement placed vertically with turned over ends.
- b. No provision for pipe flexibility along the concrete surround shall be made, unless an expansion joint is included in the slab.
- c. In normal, stable ground conditions, and with 300 mm or more of cover to the pipeline beneath the slab, a total granular surround can be used as pipe bedding.
- d. Flexibility shall be incorporated into the pipeline as it leaves any concrete surround.

24.3.6.33 Clean Up

Upon completion of the installation of the water supply lines and appurtenances, all debris and surplus materials resulting from the work shall be removed and disposed of in a manner satisfactory to the Engineer.

24.3.6.34 Measurement and Payment

24.3.6.34.1 Measurement

Measurement for water supply lines shall be made for the actual quantity of the work done in linear foot (meter) on the axis of the piping including all fittings, bends, crosses, tees etc. No deduction will be made for the laying lengths of valves, fire hydrants, specials, etc. installed in the lines.

Measurement for fire hydrants, valves, air release valves, washout valves etc. shall be made in number and shall include all other materials used to complete the work as per plans.

Thrust blocks for bends and fittings shall be measured in number and shall be inclusive of all materials to complete the item as specified.

24.3.6.34.2 Payment

The quantities measured as described above, shall be paid at the relevant unit rate (s) given in Chapter 24 of the Composite Schedule of Rates (CSR) or in the Bill of Quantities with Specified Unit Rates where applicable, and the above referred unit rate (s) and payments for supplying and laying water supply lines shall be the full compensation for all cost of completing the item of work as per provision of this chapter and shall include cost of pipe, its carriage to the site, laying, cutting, joining, testing and disinfecting, etc. and all incidentals to complete the item except fire hydrants, valves and other specials, and backing blocks which shall be paid separately.

The unit rate (s) given in Chapter 24 of the Composite Schedule of Rates (CSR), or in the Bill of Quantities with Specified Unit Rates where applicable, for the supply and installation of fire hydrants, air release valves, sluice/gate valves, washout valves and other specials and backing blocks shall be the full compensation for, supply, installation, testing, commissioning, disinfecting and all incidentals to complete these items of the work as per plans.

The number of chambers and backing block provided will be measured separately for payment.

Table of Contents

25	IRON WORKS	3
25.1	Scope	3
25.2	References	3
25.2.1	ASTM (American Society for Testing and Materials)	3
25.2.2	BS (British Standards)	4
25.2.3	AWS (American Welding Society)	4
25.3	Construction Materials	4
25.3.1	Structural Steel	4
25.3.2	Steel Forging	4
25.3.3	Steel Casting	4
25.3.4	Welding Consumables	4
25.3.5	Common Bolts, Anchor Bolts and Nuts	5
25.3.6	High Strength Bolts	5
25.3.7	Washers	5
25.3.8	Cast Iron	5
25.3.9	Storage of Materials	5
25.4	Construction Requirements	5
25.4.1	Drawings	5
25.4.2	Fabrication	6
25.4.3	Welding	9
25.4.4	Bolted and Screwed Joints	11
25.4.5	Riveting	11
25.4.6	Pins and Rollers	12
25.4.7	Setting Anchor Bolts	13
25.4.8	Erection	14
25.4.9	Correction of Errors	15
25.4.10	Tolerances	16
25.4.11	Protective Coatings	17
25.4.12	Galvanizing	17
25.4.13	Painting	18

25.4.14	Structural Steel Components	20
25.4.15	Shop Connections	23
25.4.16	Machining	24
25.4.17	Tests and Properties	24
25.4.18	Measurement and Payment	25
25.5	Steel Doors and Windows	26
25.5.1	Description	26
25.5.2	Material Requirements	26
25.5.3	Construction Requirements	27
25.5.4	Measurement and Payment	28
25.6	Aluminium Doors and Windows	28
25.6.1	Description	28
25.6.2	General Requirements	28
25.6.3	Material Requirements	29
25.6.4	Submission of Samples	30
25.6.5	Construction Requirements	31
25.6.6	Glazing	32
25.6.7	Measurement and Payment	33
25.7	Miscellaneous Steel Work	33
25.7.1	General	33
25.7.2	Steel Stairs	34
25.7.3	Steel Ladders	34
25.7.4	Steel pipe handrails	34
25.7.5	Steel protection angles	34
25.7.6	Steel Door, Windows, Ventilators, Louvers and Gate Frames	34
25.7.7	Steel Fencing	35
25.7.8	Measurement & Payment of Structural Steel Work	35
25.7.9	Measurement and Payment of Steel Embedded Parts	36
25.7.10	Measurement and Payment of Powder Coated MS Trolley Guard	36
25.7.11	Measurement and Payment of Powder Coated MS Posts & Beams	36

IRON WORKS

25.1 Scope

The works specified in this chapter consist of furnishing, preparing, fabricating, assembling, erection and painting structural steel, wrought iron, castings and forgings, plates and bolts for structures or portions of structures. Such works shall be done in accordance with these specifications and in conformity with the design and the lines, grades, dimensions and notes shown on the relevant drawings or as directed by the Engineer.

25.2 References

25.2.1 ASTM (American Society for Testing and Materials)

ASTM A6 / A6M	Standard Specification for General Requirements for Rolled Steel Plates, Shapes, Sheet Piling and Bars for Structural Use
ASTM A27 / A27M	Standard Specification for Steel Castings, Carbon, for General Application
ASTM A36 / A36M	Standard Specification for Structural Steel
ASTM A48 / A48M - 03	Standard Specification for Gray Iron Castings
ASTM A108	Standard Specification for Steel Bar, Carbon and Alloy, Cold Finished
ASTM A668 / A668M	Standard Specification for Steel Forgings, Carbon and Alloy, for General Industrial Use
ASTM A307	Standard Specification for Carbon Steel Bolts, Studs, and Threaded Rod 60,000 PSI Tensile Strength
ASTM A325/ A325M	Standard Specification for High Strength Bolts for Structural Steel Joints
ASTM F436 / F436M	Standard Specification for Hardened Steel Washers
ASTM A153 / A153M	Standard Specification for Zinc Coating (Hot-Dip) on Iron and Steel Hardware
ASTM A529 / A529M	Standard Specification for High-Strength Carbon-Manganese Steel of Structural Quality
ASTM A570	Standard Specification for Hot-Rolled Carbon Steel Sheet and Strip, Structural Quality

ASTM A709 / A709M Standard Specification for Structural Steel for Bridges

25.2.2 BS (British Standards)

BS EN 485-2 : 2016 Aluminium and aluminium alloys. Sheet, strip and plate.
+ A1:2018 Mechanical properties

BS EN 755-8:2016 Aluminium and aluminium alloys. Extruded rod/bar, tube and
profiles. Porthole tubes, tolerances on dimensions and form

BS 3987-1991 Specification for anodic oxidation coatings on wrought
aluminium for external architectural applications

25.2.3 AWS (American Welding Society)

AWS A5.1/A5.1M Specification for Carbon Steel Electrodes for Shielded Metal Arc
Welding

25.3 Construction Materials

Except otherwise stated in the drawings, the material specifications shall conform to the following sections. Wherever necessary the Contractor may use equivalent alternative material subject to approval of the Engineer.

25.3.1 Structural Steel

Structural steel for structures shall conform to the requirements of ASTM A36 / A36M.

25.3.2 Steel Forging

Steel forging shall conform to the requirements of ASTM A668 / A668M.

25.3.3 Steel Casting

Steel casting shall conform to the requirements of ASTM A27 / A27M.

25.3.4 Welding Consumables

Welding Electrodes for manual shielded metal arc welding shall conform to AWS A5.1 latest edition or the A5.5 latest edition. Equivalent locally manufactured electrodes may be used subject to the approval of the Engineer.

"AWS-Specifications for Mild Steel Arc Welding Electrodes"

25.3.5 Common Bolts, Anchor Bolts and Nuts

Bolts and Nuts shall conform to the requirements of ASTM A307.

25.3.6 High Strength Bolts

High strength carbon steel bolts including nuts and washers shall conform to the requirements of ASTM A325 latest edition.

25.3.7 Washers

Cut Washers shall be of structural grade steel and shall conform to the dimension of the manufacturer's regular standard for plain washers for the size of bolts used.

25.3.8 Cast Iron

It shall conform to the requirements of latest edition of ASTM A48.

25.3.9 Storage of Materials

Structural steel materials shall be stored above the surface of the ground, upon platforms, or other supports and shall be protected as is necessary and practicable, from exposure to conditions producing rust or other surface deterioration. They shall be kept free from accumulations of dirt, oil or other foreign matter. Girders and beams shall be placed upright and shored.

25.4 Construction Requirements

25.4.1 Drawings

- a. Design and drawings shall be prepared by the Engineer and supplied to the Contractor unless specified otherwise in the special provisions of the Contract. These shall contain main dimensions, sizes of members, typical details of joints etc.
- b. The Contractor shall then prepare construction plans, consisting of shop drawings and erection and other working plans showing detail dimensions, sizes of material and other information / data necessary for the complete fabrication and erection of the steel works.
- c. Approval of the Engineer to the construction plans shall be secured before the fabrication of steel work is commenced by the Contractor. Such approval shall constitute approval of design only, and shall not relieve the Contractor of responsibility for accuracy of details. For any deviation from such approved plans the Engineer's written order will be required.
- d. No changes shall be made in any drawing after it has been approved, except by written consent or direction of the Engineer. Substitution of section having different

dimensions than those shown on the Plans shall be made only when approved in writing by the Engineer.

- e. All steel fabricated items shall conform to the drawings, details and instructions of the Engineer. The drawings, materials, fabrication, surface preparation shall conform to the applicable requirements of relevant clauses of these specifications.

25.4.2 Fabrication

Fabrication of structural steel shall be carried out in accordance with the following requirements:

25.4.2.1 Straightening of Material

- a. Before being laid out or worked in any manner, structural material shall be straight and shall be cleaned of all rust and dirt. If straightening is necessary, it shall be done by methods that will not injure the metal. Sharp kinks or bends shall be cause for rejection of the material.

25.4.2.2 Shearing and Cutting

- a. Shearing and cutting shall be performed carefully and all portions of the work which will be exposed to view after completion shall be finished neatly. Re-entrant cuts and copes on beams or channels shall be filleted after cutting where this does not alter the geometry required for proper function.
- b. Cutting torches shall not be used, unless otherwise specifically approved.

25.4.2.3 Holes

- a. All holes in structural steel may be punched to full size unless otherwise specified. If the thickness of the material exceeds the diameter of the hole, then the hole shall be drilled. At the option of the Contractor, holes required to be drilled may be sub-punched and reamed.
- b. All holes shall be clean cut and without torn or ragged edges. All burrs resulting from reaming or drilling shall be removed with a tool making a 2/3" (1.6 mm) bevel.
- c. All holes shall be cylindrical and perpendicular to the member. Where necessary to avoid distortion of the holes, holes close to the points of bend shall be made after bending.

25.4.2.4 Punching

- a. For punching to full size, the diameter of the punch shall be 2/3" (1.6 mm) larger than the nominal diameter of the bolt and the diameter of the die shall not be more than 2/3" (1.6 mm) larger than the diameter of the punch.

- b. For sub-punching, the diameter of the punch shall be 4.8 mm smaller than the nominal diameter of the bolt and the diameter of the die shall be not more than 2.4 mm larger than the diameter of the punch.
- c. Sub-punching for reamed work shall be such that after reaming, no punched surface shall appear in the periphery of the hole. Refill of a limited number of mis-punched holes by welding will be permitted, but only after specific approval of such repairs.
- d. Where approval is given to refill mis-punched holes by welding, the steel adjacent to the holes shall be heated immediately prior to welding. After the holes have been filled by welding, the welded area and the steel adjacent to the welded area shall be heated to relieve stresses; the welded area shall be ground flush; and the holes shall be punched as required.

25.4.2.5 Reaming and Drilling

- a. Where holes are reamed and drilled the diameter of the finished hole shall be not greater than the nominal diameter of the bolt plus 1.6 mm.
- b. Refill of a limited number of mis-reamed or mis-drilled holes by welding will be permitted subject to the same provisions outlined in the preceding paragraph for mis-punched holes.

25.4.2.6 Accuracy of Punching

- a. All holes shall be spaced accurately in accordance with the Contractor's detail drawings and shall be located on the gage lines. The maximum allowable variation in hole spacing from that indicated on the detail drawings for all bolt holes shall be 1/3" (0.8 mm).
- b. Reaming or excessive drifting to match inaccurate holes will not be permitted; poor matching of holes shall be cause for rejection.

25.4.2.7 Shop Assembly

- a. The structures shall be pre-assembled in the shop to such an extent as to ensure field erection. Reaming of inaccurate holes will not be permitted.
- b. A reasonable amount of drifting will be allowed in assembling. Shop-assembled parts shall be completely dismantled for shipment.

25.4.2.8 Cleaning

- a. After the shop works have been completed and accepted, all material to be galvanized according to the Specifications shall be cleaned of rust, loose scale, dirt, oil, grease and other foreign substances.

- b. Particular care shall be taken to clean slag from welded areas. Execution of galvanizing shall conform to ASTM A 123, ASTM A153 and AST A 384.

25.4.2.9 Transportation

- a. The Contractor shall prepare all materials for transportation in a manner as to protect them from damage and corrosion in transit and shall be responsible for and make good any and all damage due to improper preparation or loading for shipment.
- b. On arrival of structural steel parts (such as columns, beams, girders, frames, lintels, railings, chequered plates, etc.) they shall be checked for damages.
- c. Any structural member that has been damaged in the course of shipment or handling to an extent of seriously affecting the properties of the members and cannot be repaired or aligned shall be immediately brought to the Engineer's attention. Should the Engineer determine that any structural member is not repairable, then the Contractor will be notified to furnish a new member.

25.4.2.10 Unloading and Handling

- a. All material shall be carefully handled and stacked to prevent deformation or damage.
- b. All structural steel members shall be carefully stored on substantial timbers and blocking, so arranged so that the steel will be free from the earth and properly drained, preventing any spattering with dirt or the accumulation of water in or about steel.
- c. Care shall be taken to prevent damage to the shop coat of paint and prevent the accumulation of mud, dirt or other foreign matter on the steel.

25.4.2.11 Facilities for Inspection

- a. The Contractor shall furnish all facilities for the inspection of materials and workmanship in the mill and shop, and inspector shall be allowed free access to the necessary parts of the premises.

25.4.2.12 Rejection of Fabricated Work at Site

- a. The Engineer may waive shop inspection and make complete inspection of all fabricated work upon its delivery at the site of the structure.
- b. Whether or not shop inspection is made fabricated steel may be rejected at any time it might be found as not conforming to the plans and specifications.

25.4.2.13 Marking and Shipping

- a. Members weighing more than three tons (3000 kg) shall have the weight marked thereon. Bolts and rivets of one length and diameter, and loose nuts or washers of

each size, shall be packed separately. Pins, small parts, and small packages of bolts, rivets, washers and nuts shall be shipped in boxes, crates, kegs or barrels of convenient sizes. A list and description of the contained material shall be plainly marked on the outside of each shipping container.

- b. The weight of all tools and erection material shall be kept separate.
- c. Anchor bolts washers and other anchorage or grillage materials shall be shipped to suit the requirements of the masonry construction.
- d. The loading transportation and unloading of structural material shall be so conducted that the metal will be kept clean and free from injury by rough handling.

25.4.3 Welding

25.4.3.1 Preparation for welding

- a. All welds shall be made in such a manner that residual stresses will be reduced to a minimum. The weld seams shall, as far as possible, be positioned outside zones of stress concentration.
- b. Full information and specifications of all principal weld seams shall be a part of the design drawings. The drawings shall indicate the type of weld, choice of electrodes, wires and welding powders to be employed. The number of welding passes shall be made in relation to the thickness of the plate, each pass shall be thoroughly de-scaled before the next pass is applied. For complicated parts, the sequence of welding shall be indicated clearly on the respective drawings.
- c. Members and sections to be joined by welding shall be cut accurately to size, with their edges ground or machined to suit the required type of welding and to allow full penetration and fusion of the weld with the base material.
- d. The surface of members or sections to be welded shall be free from rust, grease, mill scale, and other foreign matter for a distance of at least 1-1/4" (30 mm) back from the edge of weld. All painting materials shall be removed well back of the heat-affected zones. Welding over zinc primers shall be avoided.

25.4.3.2 Welding Procedure

- a. The standard of welding works shall be in accordance with AWS.
- b. All welding shall be performed by the Shielded Metal Arc Method (SMAW). The welding procedure shall be selected in consistence with the composition and properties of the base material, type of weld and working stresses of the welded joint. Whenever required, pre-heating and heat treatment of the welding seam shall be applied.
- c. The mechanical properties of the weld shall conform to the base material as specified in the respective standards.

- d. All joining of plates in the principal stress direction shall be carried out using either single-welded or double-welded butt joints. Adjacent plates, carrying high stresses, shall in general not differ more than 1/10" (3 mm) in thickness. If the difference is greater, the thicker plate shall be chamfered maximum 1:4.
- e. Principal welds shall be ground.
- f. Cracked or defective tacks shall be removed before welding.
- g. For double-welded butt joints, the root must be completely removed by grinding or back-gauging before proceeding with the welding on the other side in order to prevent the presence of residues.
- h. Where auxiliary structural members are welded to components for the purpose of assembly and installation, the connecting welds shall be given particular care. Once an installation has been completed, these auxiliary structural members shall be removed by burning them off, followed by grinding the affected areas flush with the plate, without introducing additional local thermal stresses. Knocking-off of such members shall not be permitted.
- i. The electrodes for arc-welding shall be classified on the basis of mechanical properties of the as-welded deposited weld metal, type of covering, hydrogen absorption, welding position of the electrodes and type of current.
- j. Electrodes shall be used only in the positions and under the conditions of intended use in accordance with instructions with each container. Electrodes for manual welding shall be suitable for welding in any position.
- k. During the welding operations the electrodes shall be stored and dried in electric heaters prior to welding, according to the instructions from the manufacturer.
- l. The ignition of welding-electrodes shall not be initiated at the steel surface adjacent to the weld, but at the groove flanks to prevent detrimental increments of local hardness. Where ignition points of electrodes are discovered, they shall be ground appropriately.

25.4.3.3 *Welding of Stainless Steel*

- a. All welding of stainless steel shall be carried out using the inert gas method (TIG/MIG). Pipes shall be locally filled with inert gas during welding.
- b. Butt welds on thin walled pipes shall have a smooth, fully penetrated weld seam in and outside. Partly penetrating, drops or metal sputter shall not be accepted.
- c. All welds and heat affected zones shall be carefully de-scaled and cleaned with a suitable cleaning paste and fresh water if inert gas has not been applied or if the inert-gas method has failed. Carbon-steel tools shall not be used.

25.4.3.4 Heat Treatment

- a. The need for heat treatment shall be determined, taking into account the stress levels and design temperature, material properties including notch toughness, material thickness and forming, welding and inspection procedures according to internationally accepted standards. The shop heat treatment of welded components shall be performed on the completed component prior to final machining.
- b. Procedures for heat treatment shall be submitted to the Engineer for approval.
- c. Heat treatment of site welding shall be performed according to the specifications for the welding procedure for the corresponding parts, which shall be submitted to the Engineer for approval.

25.4.3.5 Quality and Procedure Control

- a. Quality testing and inspection methods, e.g. inspections by non-destructive testing (NDT) means, shall be carried out as directed by the Engineer.

25.4.4 Bolted and Screwed Joints

- a. Bolted joints shall be performed in accordance with good engineering practice and approved standards. All holes shall be made by drilling, reamed where required and otherwise made to fit the bolts with required accuracy.
- b. All bolts shall have washers and locks as required. Members to match accurately shall be fitted with guide pins. Holes for bolts and screws shall in general have the same corrosion protection as the rest of the equipment.
- c. Bolts and screws shall have standard metric threads and be of high quality steel.
- d. All standard-size bolts, studs, nuts and screws (including their washers) shall be protected against corrosion, or made of stainless steel if so specified. Nuts and bolt-heads shall be hexagonal in shape and truly faced.
- e. Bolts and screws with sunk heads such as Hexagon Socket Head Cap Screws or Hexagon Socket Countersunk Head Cap Screws shall be made from stainless steel only unless otherwise approved by the Engineer.

25.4.5 Riveting

- a. Rivets shall be heated uniformly to a light cherry red colour and shall be driven while hot. The points of rivets shall not be heated more than the remainder. When ready for driving they shall be free from slag, scale and other adhering matter, and when driven they shall completely fill the holes.
- b. Burned, burred or otherwise defective rivets, and rivets which throw off sparks when taken from the furnace or forge, shall not be driven. Rivets shall be driven by

power tools. The use of hand tools for riveting will not be permitted unless specifically authorized in writing by the Engineer.

- c. Hand passing throwing of rivets is desirable, but any other method of conveying rivets from the forge to driving point must be approved by the Engineer. No cold rivets shall be driven.
- d. Assembled parts shall be brought into close contact, and drift pins shall be used only for bringing members into position, not to enlarge or distort holes.
- e. Rivets which are loose, burned, badly formed or otherwise defective shall be cut out. Calking and re-cupping of rivet heads shall not be done. In cutting out defective rivets care shall be taken not to injure the adjacent metal and, if necessary, the rivet shank shall be removed by drilling.
- f. Countersinking shall be neatly done and countersunk rivets shall completely fill the holes.

25.4.6 Pins and Rollers

25.4.6.1 General Requirements

- a. Pins and rollers shall be accurately turned to detailed dimensions and shall be smooth, straight and free from flaws; the final surface shall be produced by a finished cut.
- b. Pins and rollers having a diameter greater than 6" (150 mm) shall be forged and annealed.
- c. Pins and rollers larger than 8" (200 mm) in diameter shall have a hole not less than 2" (50 mm) in diameter bored longitudinally through their centers. The hole shall be bored after forging and before annealing. Pins and rollers showing defective interior conditions will be rejected.
- d. Pin holes shall be bored true to detailed dimensions, smooth and straight, straight angles with the axis of the member and parallel with each other unless otherwise required. A finished cut shall always be made.
- e. The length outside to outside of holes in tension members and inside to inside of holes in compression members shall not vary from detailed dimensions more than 1/32 inch (1 mm). Boring of holes in built-up members shall be done after riveting is completed.

25.4.6.2 Pin Clearances

The difference in diameter between the pin and the pin holes shall not be more than 1/32 inch (1 mm).

25.4.6.3 *Screw Threads for Pins*

Screw threads shall make close fits in the nuts and shall be U.S. standard except that for diameters greater than 1/2" (13 mm) they shall be made with six threads to the inch.

25.4.6.4 *Pilot and Driving Nuts*

Two pilot nuts and two driving nuts shall be furnished for each size pin unless otherwise shown on the plans.

25.4.6.5 *Notice of Rolling and Fabrication*

The Contractor shall give ample advance notice to the Engineer of the beginning of work at the mill and shop, so that inspection may be provided. No material shall be rolled or fabricated before the Engineer has been notified where the orders have been placed.

25.4.7 Setting Anchor Bolts

- a. Where the substructure and superstructure are built by different contractors, anchor bolts shall be set by the substructure contractor. It shall, however, be the responsibility of the superstructure contractor to provide the substructure contractor with anchor bolts and correct plans for their setting, and he shall cause the substructure contractor no delay in such work. In any case it shall be the responsibility of superstructure contractor to inspect the setting of anchor bolts at the time the work is being done and, to check the placing of them. Any expense incurred because of any error in setting anchor bolts shall be borne by the superstructure contractor.
- b. The location of the anchor bolts in relation to the slotted holes in expansion shoes shall be varied with the prevailing temperature. The nuts on anchor bolts at the expansion ends of spans shall permit the free movement of the span.
- c. Unless otherwise shown on the Plans anchor bolts shall be set by one of the three methods specified below. Any one of these methods may be used at the option of the Contractor, unless the Engineer designates the methods to be used in any particular case.

25.4.7.1 *Setting Bolts in Drilled Holes*

- a. Anchor bolt holes shall be drilled in correct location, vertically to the plane of the bridge seat and the anchor bolts set in Portland cement mortar therein. The mortar shall consist of one part cement of one part clean, fine grained sand, mixed sufficiently wet to flow freely. Anchor bolts shall first be dropped into the dry holes to assure their proper fit after setting. They shall then be set as follows:
- b. Fill the holes about two thirds full of mortar and by a uniform, even pressure or by light blows with a hammer (flogging and ramming shall not be done) force the bolt

down until the mortar rise to the top of the hole and the anchor bolt nut rests to the top of the holes and the anchor bolt nut rests firmly against the metal show or pedestal. Remove all excess mortar which may have flushed out of the hole, to permit proper 'field painting of the metal surface.

25.4.7.2 *Setting bolts in Formed Holes*

Bolt holes in concrete may be formed by the insertion of oiled wooden plugs or metal pipe sleeves in the fresh concrete. They are subsequently withdrawn after concrete has partially set. When the holes are formed by the latter method they shall be not less than 4" (100 mm) in diameter to allow for horizontal adjustment of the bolts.

25.4.7.3 *Setting bolts directly in concrete*

When setting Bolts directly in Masonry, the anchor bolts are set to the exact location in the concrete when it is placed. In this case great care shall be exercised to insure the proper setting of the bolts, and any inaccuracies which would be detrimental to the structure shall be corrected by suitable means.

25.4.7.4 *Preparation of bearing area and setting shoes and pedestals*

- a. Column bases, truss and girder pedestals and shoes shall have full and uniform bearing on the substructure masonry. Masonry bearing plates shall not be placed on the bridge seat area of piers or abutments which are improperly finished, deformed or irregular.
- b. The shoes and pedestals of truss and girder spans and of L-beam spans, the bases of column, and the center and end bearing of swing spans shall be rigidly and permanently located to correct alignment and elevations.

25.4.8 Erection

- a. Before commencement of erection, the Contractor shall closely inspect the Site and all the foundation and other structures at and on which parts of the work supplied under these Specifications will be installed and he shall check the conformity of the foundation with erection drawings. The result of this check shall be transmitted to the Engineer in sufficient time to allow any errors to be corrected before the commencement of erection.
- b. The Contractor shall be responsible for the accurate establishment and maintenance of building lines, bench marks and required elevations for the proper erection of steel at Site.
- c. Before erection, all parts of the work shall be cleaned of all contamination such as dust, sand, rust; loose mill scale and other dirt.

- d. The Contractor shall provide storage and handling areas for the intermediate storage of part for the structures. The necessary space for these facilities will be provided at Site.
- e. Bolts, pins, packing, tools, insulation materials, electrical parts and parts with electrical devices attached, electrical motors, instruments, welding material and equipment, all small parts and all, parts of the work which have already been finish painted in so far as these require not inordinately large space requirements.
- f. All individual pieces shall be marked with the correct designation shown on the Contractor's detail drawings. Marking shall be done by stamping the marks into the metal before galvanizing, or painting and shall be clearly legible after treatment.
- g. In designing members on shop drawings, the Contractor shall endeavour to use as few designations as possible and each member of identical size and detail shall have the same designation, regardless of its position in the structure.
- h. The erection of the parts of the work shall be properly carried out and in accordance with the erection instructions of the manufacturer or with the currently valid regulations concerning material handling, welding, etc.
- i. Machines and bed plates shall be erected true and grouted in. Any hollows or internal spaces shall be provided with drains.
- j. Hammering that might injure or distort the members shall not be permitted. Members shall not be overstressed during the process of erection. Bearing surfaces to be in permanent contact shall be carefully cleaned before the members are assembled or erected in bolted connections, the bolts shall be drawn tight and secured by lock washers. Erection bolts and pins shall be furnished by the Contractor.
- k. All embedded miscellaneous metalwork shall be set accurately in position and shall be supported rigidly to prevent displacement during the placing of concrete.
- l. All parts of the work are to be protected from the time of delivery until final acceptance of the whole work, against damage of any kind.
- m. Special care shall be taken on to injure the skin on galvanized or specially treated surfaces during erection. Care shall be taken to prevent or remove any rust streaks or foreign matter deposited on galvanized surfaces during storing or transport or after erection.

25.4.9 Correction of Errors

Correction of minor misfits and a reasonable amount of reaming and cutting of excess stock from rivets will be considered as a legitimate part of erection. Any error that may occur in shop work which prevent the proper assembling and fitting of parts by moderate use of drift pins, or a moderate amount of reaming and slight chipping or

cutting shall immediately be called to the attention of the Engineer and approval of the method or procedure of correction shall be obtained or such method or procedure shall not be employed. The use of cutting torches to enlarge or alter bolt or rivet holes shall be prohibited.

25.4.10 Tolerances

Deviations from the theoretical shape on primary structural members shall not exceed the following, unless otherwise specified:

25.4.10.1 Deviation of curved surfaces

Deviation of curved surfaces between measured and theoretical curvature shall not exceed 0.2 % of diameter D, over a chord length of 0.2 D. The pipes or shells shall throughout the entire circumference have a positive curvature with no dents.

25.4.10.2 Fitting and Alignment of Plates

Definition	Principal joints	Secondary joints
Maximum misalignment of centreline of plates	0.1t maximum 3.0 mm	0.1t maximum 3.0 mm
Maximum misalignment of surfaces	0.1t maximum 3.0 mm	0.1t + 1 mm maximum 4.0 mm

Principal joints are perpendicular to the main stresses, secondary stresses parallel.

25.4.10.3 Weld Seam Convexity

	Convexity
t < 12 mm	1.5 mm
13 mm < t < 25 mm	2.5 mm
26 mm < t < 52 mm	3.0 mm

- a. Between the centrelines of principal members:

± 5 mm up to 15 m

± 10 mm over 15 m

Note: The ± 10 mm tolerance shall not be cumulative.

In storey height:

± 5 mm floor to floor.

- b. In plumbness of columns and walls

± 10 mm on any storey or over all the structure

c. Symbols (units in mm):

D = internal diameter of pipes or 2 x radius of curved plates

t = thickness of the plates

L = measured length of pipe, profile, plate.

25.4.11 Protective Coatings

- a. Protective coatings of steel works shall be applied in accordance with the manufacturer's instructions. The requirements for such coatings shall comply with the appropriate clauses in BS 449 and B.S.C.P. 2008.
- b. All surfaces which are to be painted, oiled or otherwise treated shall be dry and thoroughly cleaned to remove all loose scale and loose rust.
- c. Shop contact surfaces need not be painted unless so specified. If so specified, they shall be brought together while the paint is still wet. Surfaces not in contact, but inaccessible after shop assembly, shall receive the full specified protective treatment before assembly. This does not apply to the interior of scaled hollow sections.
- d. In the case of surfaces to be welded, the steel shall not be painted or metal coated within a suitable distance of any edges to be welded if the paint specified or the metal coating would be harmful to welders or impair the quality of the welds.
- e. Welds and adjacent parent metal shall not be painted prior to deslagging, inspection and approval.
- f. Parts to be encased in concrete shall not be painted or oiled.
- g. The specified protective treatment shall be completed after erection. All rivet and bolt heads and site welds after deslagging shall be cleaned. Damaged or deteriorated shop-applied paint surfaces or metal coatings shall be made good with the same type of paint as the shop coat and this coat shall be completed on site so as to be continuous over any welds and site rivets or bolts. Protection may be completed by painting on site subject to approval by the Engineer. Bolts which have been galvanized or similarly treated are exempted from this requirement.
- h. Site painting should not be done in very cold or misty weather or when humidity is such as to cause condensation on the surfaces to be painted.

25.4.12 Galvanizing

Galvanized coatings shall comply with the requirements of BS 729 and shall have a surface coating of zinc of not less than 750 g/m² applied by the hot dip process.

25.4.12.1 Galvanizing of Plates and Shapes

After being cleaned, the material shall be zinc coated (galvanized) in accordance with applicable Standards. Where members are of such lengths that they cannot be dipped on one operation great care shall be exercised to prevent warping.

Finished compression members shall not have lateral variations greater than one-thousandth of the axial lengths between the points which are to be supported laterally. Finished tension members shall not have lateral variations exceeding 3 mm for each 1.50 m of length. Sharp kinks or bends will be cause for rejection of the material. All holes in material shall be free of excess spelter after galvanizing.

25.4.12.2 Galvanizing of Hardware

Bolts, nuts, washers, locknuts and similar hardware shall be galvanized in accordance with the relevant Standards. Excess spelter shall be removed by centrifugal spinning.

25.4.12.3 Straightening After Galvanizing

All plates and shapes which have been warped by the galvanizing process shall be straightened by being re-rolled or pressed. The material shall not be hammered or otherwise straightened in a manner that will injure the protective coating. If the material has been harmfully bent or warped in the process of fabrication or galvanizing, such defects shall be cause for rejection.

25.4.12.4 Repair of Galvanizing

Materials of which galvanizing has been damaged shall be re-dipped unless the damage is local and can be repaired by soldering or by applying a galvanizing repair compound, in which case the compound shall be applied in accordance with the manufacturer's instructions.

Soldering shall be done with a soldering-iron using 50/50 bar solder (tin and lead). Surplus flux or acid shall be washed off promptly and the work shall be performed so as not to damage the adjacent coating or the metal itself. Any member on which the galvanized coating becomes damaged after having been dipped twice shall be rejected.

25.4.13 Painting

25.4.13.1 Primer Paints

The following particulars relate to the priming paints which shall be used:

25.4.13.2 Red Lead Primers

Red lead in linseed oil priming paints for steel shall be to B.S.2521 and B.S.2523 Paints in other types of medium containing mixtures of not less than 50% of red lead with other pigment, such as graphite or red iron oxide, may also be used if approved.

25.4.13.3 Calcium Plumbate Primers

Calcium plumbate priming paints for steel shall be to BS 3698. Two different types mixed in an oil-based medium, which dry rather more rapidly than red lead primers, are acceptable. Quick drying calcium plumbate primers in other media may also be acceptable. The Contractor should consult the Engineer for his ruling.

25.4.13.4 Metallic Lead Primers

Metallic lead primers shall consist of finely divided metallic lead pigment in admixture with other pigment. The metallic lead content of the pigment mixture should be at least 40% by weight, but more than this if the recipient section is to be exposed to severely corrosive conditions. The medium is normally oleoresinous but may be of a chemical-resistant type. The primer shall comply with BS 2521 and 2523, or be as stated for zinc chrome primers.

25.4.13.5 Zinc Chrome Primers

Zinc chrome primers shall consist of zinc chrome pigment to BS 282, types 2 or 3, plus other inert pigment or extenders, or both, in an oleoresinous medium. There is no British Standard for these primers, but Defence Specifications cover two types: DEF 1035-C, which contains at least 15% of zinc chrome and 60% of red iron oxide in the pigment, and DEF 1039, which contains at least 40% of zinc chrome. When used in a coastal environment over a metal coating the DEF 1039 type with the higher zinc chrome content shall be used.

25.4.13.6 Zinc-rich Primer

The metallic zinc pigment in these primers should be bound in a medium of chlorinated rubber, polystyrene or epoxide resin, so as to yield paint suitable in all respects for brush application. The dry paint film should contain not less than 85% by weight of metallic zinc.

25.4.13.7 Bituminous Coating

Bituminous coating solution for cold application shall comply with the requirements of BS 3416 Type 1 or 2, as detailed. Type 1 shall be used for coating general iron or steel work. Type 2 shall be used for coating the inside of drinking water tanks or wherever the metalwork will be in direct contact with water.

25.4.13.8 Sprayed Metal

Sprayed metal coatings shall comply with the requirements of BS 2569: Part 1.

25.4.13.9 Field Painting

- a. After assembly welding spots shall be ground smooth, the first coat shall be repaired and a second coat similar to the above mentioned shall be provided.

- b. Isolation of non-compatible metals shall be provided in all installation by giving the metal a coat of asphalt and an isolation barrier (i.e. asphalt impregnate felt) to prevent contact with dissimilar metals, masonry, concrete or plaster.
- c. Galvanized structural steel parts except girders and gratings shall also be provided as mentioned above.
- d. All field rivets, bolt and welds, and all serious abrasions to the shop coat shall be spot painted with the same material used for the shop coat or an equivalent, and all mud, grime and other firmly attached foreign and objectionable materials shall be removed. Then, a through coat of approved field paint shall be applied to all steel work, except when steel comes in contact with concrete.
- e. After erection, the finish coat of painting on Site shall be carried out in accordance with the painting specifications and any damaged restored.

25.4.13.10 *Steel work/Surfaces not to be painted*

- a. Steel work to be encased / embedded in concrete or surface in coated with contact with concrete or grout shall not be painted, but shall be given a cement wash after sand blasting.
- b. Machined finished surfaces shall not be painted but shall be coated with rust' preventive compound, (approved by the Engineer) immediately after finishing. Such surfaces shall also be protected with wooden pads or other suitable means for transportation. Unassembled pins, keys, and bolt thread shall be greased and wrapped with moisture resistant paper.

25.4.14 Structural Steel Components

25.4.14.1 *Chequered Plates*

- a. Chequered plates for floors and platforms shall be of thickness and locations as indicated on the drawings. Chequered plates that are to be removable shall be provided with two lifting holes, and size of plates shall be such as to afford easy handling; other plates shall be provided with fasteners as shown on the drawings. All plates shall rest flat on their supports without rocking. All edges of plates shall be ground or cut, smooth and straight with 3 mm clearance between plates.
- b. Un-braced chequered plate shall be stiffened with angles where required. Where chequered plates shall be fitted to supporting members, they shall be secured by countersunk, flat-head bolts or screws, or welding. Cut-outs and openings required for chequered plates shall be shop formed and reinforced to dimensions and locations shown on certified drawings or the Engineer instructed requirements.
- c. The Contractor shall furnish banding strips or angles for openings required to be cut in the field, as well as all other necessary accessories for chequered plate required for field installation. Where chequered plate is shown on drawings to be furnished

with grating it shall be securely shop welded. Type of chequered plates will be subject to the Employers/Engineers choice.

25.4.14.2 Welded Steel Grating

- a. Steel gratings shall be welded type rectangular pattern of sizes as indicated on the drawings. Gratings shall be hot-dipped galvanized after fabrication. All grating indicated as removable shall be bolted or clipped to supports. Sizes of grating shall be such as to afford easy handling.
- b. The Contractor shall cut, as shown on all certified drawings, neat, circular or square openings for the passage of pipes, ducts, etc., through gratings. He shall band all openings with 6 mm steel plate of height to match the toe plate height where shown, otherwise with 15 cm width, and weld the band to each intersecting member of grating.
- c. The Contractor shall furnish the necessary material for all other cut-outs or openings to be performed in the field, provide toe plates at all unprotected open sides at ends of grating and where shown on drawings. All gratings shall be arranged so that bars in either direction are in line. Bearing bars shall be of depth required to support the design loads at allowable stresses and a deflection not exceeding 1/250 of span length.

25.4.14.3 Steel Stairs

- a. Stair-work shall be furnished and installed with all stringers, treads, risers, newels, hangers, railings, kick plates and all appurtenance members. Construction shall be rigid and substantial throughout, all joints closely fitted, rivets, bolts and screws concealed where practicable or dressed flush.
- b. Members shall be punched, drilled and tapped as required for installation of furring, applied or abutted materials. Stair construction framed to structural steel supports shall follow the erection of the steel work as closely as practicable and be securely bolted to the steel framing. All stair-work shall be fully protected, during the construction period, by temporary board treads and landing covers.
- c. The Contractor shall furnish and install all walkways, stairs and platforms, (complete with handrails, kick plates, equipment guards, supports and bracing) required for the safe and convenient operation, maintenance and repair of the equipment and accessories.
- d. Walkways, stairs and platforms shall provide a clear width of not less than 3 ft (1.0 m) and shall be complete with kick plates on all sides. Stairs shall be designed for a rise of about 8" (200 mm) and a run of about 9" (230 mm) with successive treads lapped about 3/4" (20 mm) making overall tread width about 10" (250 mm). Vertical clearance for walkways stairs and platforms shall be not less than 84" (2100 mm)

and inclined clearance normal to the slope of the toes of treads not less than 76"(1900 mm) unless otherwise approved by the Engineer.

- e. Floor surfaces of walkways, stairs and platform shall be chequered plate or steel grating designed to support a live load of not less than 500 kg per sq.m. Grating shall be of the open type welded and galvanized with a banded edge and be rectangular pattern. It shall be composed of parallel bearing 1-1/4" x 3/16" (32 mm x 5 mm) at 1-3/16" (30 mm) pitch. Transverse bars shall be of non-slip type at 4" (100 mm) pitch. Deflection should be restricted to 1/250 of span. Walkways, stairs and platforms shall be mounted on resilient material furnished and installed by the Contractor.

25.4.14.4 Treads and Intermediate Landing of Stairs

These shall be formed of steel gratings, sizes as necessary, with angle connections to stringers and with nosing of chequered steel plate or abrasive metal. No riser required. Treads shall have punched and slotted side plates for bolting to stringers and accessories.

25.4.14.5 Plate Girders

- a. Web plates of girders having no cover plates may be detailed with the top edge of the web flush with the backs of the angles. Web plates of girders having cover plates may be 1/2" (13 mm) less in width than the distance, back to back top flange angles.
- b. Where web plates are spliced there shall be not more than 3/8 inch clearance between ends of plates.
- c. End stiffener angles of girders and stiffener angles intended as supports for concentrated loads shall be milled or ground to secure a uniform, even bearing against the flange angles. Intermediate stiffener angles shall fit sufficiently tight to exclude water after being painted.
- d. Web plate plates and fillers under stiffeners shall fit within 1/8" (4 mm) at each end.

25.4.14.6 Stringers

- a. Face and wall stringers shall be fabricated of channel steel sections of size and weight necessary, framed in complete units with all joints welded in the unit channels.
- b. Face stringers shall be carried around intermediate landings with the top not less than 3 inches above the landing surface. Wall stringer shall extend up full flight of stairs, around all intermediate landings, neatly finished at floors. Stringers for grating tread shall be punched to receive tread bolting.

25.4.14.7 Angle or Channel Frame for Floor Openings

Steel angle and/or channel frames shall be provided for all openings in the sizes and shapes indicated. The Contractor shall provide anchors securely welded to each side of the steel frame or as otherwise indicated on the drawings. All corners of frames shall be mitred and continuously flush-welded.

25.4.14.8 Sheet Metal Work

- a. Workmanship shall conform to the best standards of practice in modern sheet metal shop, and the work shall be accurately formed to the dimensions and shapes indicated on the drawings. Formed, moulded, and cut members shall finish with true, straight and sharp lines and angles, and where intercepting each other, shall be coped to an accurate fit and soldered.
- b. Sheet metal work shall be formed, fabricated and installed to provide for expansion and contraction. Exterior work shall be finished water and weather tight, and flat lap seams shall be made in the direction to flow.

25.4.14.9 Bonding of Copper Strips to Steel work

- a. Approved means shall be provided for fixing and bonding copper strips to the steelwork at sufficient points to secure efficient grounding. Grounding connections shall be made to a vertical face clear of the soil; foundation bolts shall not be used for their attachment.
- b. The treatment of copper grounding strips prior to their attachment to steel structures shall be subject to the Engineer's approval.

25.4.15 Shop Connections

- a. For welded connections, the welding electrodes shall conform to "AWS-Specifications for Mild Steel Arc Welding Electrodes" Contractor shall prepare and submit for approval welding procedures for all shop and field welds and shall not proceed with fabrication until Engineer's approval is received.
- b. For welding of any particular type of joint, welder shall be tested and approved by the Engineer. The standard accepted shall be as described in the "Code of Welding in Building Construction" of the American Welding Society or any other code subject to the Engineer's approval.
- c. All full penetration welds shall be ultrasonically tested by qualified personnel out of Contractor's company, (Special testing institutes). Records of all tests shall be submitted to the Engineer by the testing institutes. All steel parts that are required to be galvanized shall not be welded on after galvanizing.
- d. Where bolted shop connections are indicated or allowed ASTM A-325 heavy hexagonal head bolts with heavy semi-finished nuts shall be used. Bolted

connections shall conform to the requirements of AISC Standard friction connections unless otherwise shown on drawings.

25.4.16 Machining

- a. Machining of all parts shall be accurate and to specific dimensions so that replacements made as per design drawings may be readily installed. Like parts and spare parts shall be interchangeable.
- b. All machining shall be performed to secure proper matching of adjoining surfaces. If there are discrepancies between adjoining surfaces, these shall be ground smooth, or machined, to proper alignment. Unfinished surfaces shall be true to the lines and dimensions shown on the drawings, and shall be ground to be free from projections and rough spots.
- c. The surface finish of all parts and components shall conform with the respective strength and service requirements and as per approved drawings. Surface to be finished by machining shall be indicated on the shop drawings by corresponding standard symbols.

25.4.17 Tests and Properties

25.4.17.1 General

- a. All materials to be supplied and installed shall be in accordance with the relevant Standards given in section 13.3 of this chapter.
- b. Selection of samples for testing material will be made by the Engineer.

25.4.17.2 Test Prior to Shipment

- a. Before and during fabrication, the Engineer shall have access to all workshops as and when he so desires. The tests and inspection shall be carried out by an authorized official of the Employer. The Acceptance and test certificates shall be made available to the Engineer in an adequate number of copies.
- b. Castings and forging shall be tested with suitable modern procedures. Tests are to be carried out on the premises of manufacturers of castings and forging on work-pieces in the rough state in order to detect flaws in good time and therefore to avoid delays in delivery as far as possible. After partial machining in the works of the manufacturer further tests may be carried out.
- c. The Contractor shall allow the Engineer access to any and all test reports on request. If necessary, parts of the structure may be provisionally assembled in the assembly shops of the Contractor in order to check the correctness of measurements.

25.4.17.3 Testing on Site

- a. During erection the Contractor shall carry out all necessary inspection checks and tests at suitable intervals in order to guarantee safety on the Site under the given conditions of erection and the orderly execution of the erection in accordance with the Specifications, the drawings and the erection regulations.
- b. After final erection of the structure, inspections, checks and tests shall be carried out by the Contractor in the presence of the Engineer, in order to demonstrate the completeness of the Works, the correctness of the assembly, and evidence of the guaranteed performance values.
- c. To facilitate inspections and maintenance, the structures shall be provided with steps, ladders, handrails, screens, guard and other facilities in approved positions. The Contractor shall also provide to the Engineer all the equipment necessary for inspecting the tightening of high strength bolts:

25.4.18 Measurement and Payment

25.4.18.1 Measurement

Structural steel work shall be measured by net area or by net weights as specified in the unit rate (s) of the relevant item (s) of Chapter 25 of the Composite Schedule of Rates (CSR) or in the Bill of Quantities with Specified Unit Rates where applicable. The unit rate (s) shall cover the complete structure and shall include for supply, erection, protective coatings, etc. as specified. Design and preparation of detailed shop drawings deemed necessary shall be included in the above referred relevant unit rate (s).

- a. The quantity of Structural Steel entering into and becoming a part of the completed structure, and accepted by the Engineer shall be the computed weight in cwt of this material entering into the completed structure of item of work. The length to be used in the calculation shall be detailed length to be paid for and as shown on the plans.
- b. The unit of measurement of structural steel work shall be one kg. Structural steel weights shall be the standard computed weights of the various metals.
- c. The weights of rolled shapes, bars, plates and pipe railings shall be computed on the basis of the nominal weight as given in manufacturer's handbooks, using the dimensions shown on the Plans. The weight shall be computed on the basis of rectangular dimensions and ordered overall lengths for all structural shapes, except that;
 - i. When parts can be economically cut in multiples from material of larger dimensions, the computed weight shall be that of the material from which the parts are cut and,

- ii. All material shall be ordered to produce as little waste as possible when cut and finished by modern shop methods. The weight of shims shown on the Plans shall be included in the quantity of Structural Steel.
- d. No deductions from the computed weight of rolled steel shall be made for caps, clips, sheared edges, punching, borings, drillings, mil-ling or planning and no allowance shall be made for the weight of weld metal or for overrun in weight.
- e. The weights of shop and field rivets and of high-strength bolts, included nuts and washers, all as installed and accepted shall be computed on the basis of average lengths in accordance with the following table;

Diameter of Rivet or Bolt	3/4" (20 mm)	7/8" (22 mm)	1" (25 mm)
Weight in lbs (kg) per 100 Nos.	50(22.7)	100(45.4)	150(68.1)
- f. The quantity to be paid for shall be the original plan quantity, determined as provided above.

25.4.18.2 Rate

- a. The unit rate (s) shall be full compensation for all the work described in this Section, including welding and all paint materials and planning.
- b. No separate payment will be made for false work or other erection expenses.

25.4.18.3 Payment

Payments shall be made as per unit rate (s) for relevant item(s) given in Chapter No. 25 of the Composite Schedule of Rates (CSR), or in the Bill of Quantities with Specified Unit Rates where applicable, and these unit rate (s) shall constitute full compensation for all the works related to the respective item(s).

25.5 Steel Doors and Windows

25.5.1 Description

Providing making and fixing steel doors, windows and ventilators single or double leaf, single shutter or double shutter, fully panelled or partly panelled and include providing and fixing of wire gauze, glazing, all mongery fittings or fixtures if required and shown on drawings or as directed and conforming to the relevant B.S./ASTM Specifications.

25.5.2 Material Requirements

All materials steel sections, etc. shall comply with the specifications given in respective section. The steel sections shall be according to ones shown in the drawings and shall be free from injurious matter air-holes blows wounds spitted grains un-cleaned and blunt rises and crevices.

25.5.3 Construction Requirements

The steel sections shall be thoroughly straightened in the shape by methods that will not injure it before being laid off or worked in any way.

25.5.3.1 Cutting & Forming

All members shall be so cut and formed that they can be accurately assembled without being unduly cracked strained or forced into position.

25.5.3.2 Jointing

The jointing of different parts of the members of mild steel shall be carried out by welding process with the help of electric/hydroxyl flame. Welding points should be made quite smooth by filing them and should conform to the width stipulated in the relevant drawings.

25.5.3.3 Wire Gauze

Unless otherwise specified or directed the 22 gauge, 12x12 mesh wire gauze shall be fixed.

25.5.3.4 Glazing

Glazing shall be strictly according to the specifications given in respective section and shall be fixed as shown on the drawings.

25.5.3.5 Fittings and Fixtures

All mongery fittings fixtures shall be of approved quality and shall be fixed as per standard practice or as per drawings. All the welding points shall be smoothed by filling and the heads of bolts sunken in the frame.

25.5.3.6 Fixing

- a. All the frames of doors and windows shall be fixed at site with the hold fasts of specified size and number and as shown on drawings with proper alignment and plumb.
- b. All finished members must be free from twists bends or open joints and shall strictly be in accordance with drawings.

25.5.3.7 Protection during Construction

- a. Unless otherwise permitted in writing or if shown otherwise on drawings the steel windows shall be placed in position before the work reaches the sill level so that they can be built in as brick work as masonry proceeds. The Contractor shall take care to protect the work from any damage of whatsoever nature during the construction period. In case of any such damage done to the work the Contractor shall remove replace or rectify such work at his own cost.

- b. The windows shall be painted with primary coat of red oxide and good quality of double boiled linseed oil or any approved anticorrosive paint after proper grinding and two coats of synthetic enamel paint of approved make. No extra payment shall be made for such work.

25.5.4 Measurement and Payment

25.5.4.1 Measurement

The measurement shall be made in sq. ft (sq. m) of the actual surfaces completed and approved.

25.5.4.2 Payment

Payments shall be made as per unit rate (s) for relevant item(s) given in Chapter No. 25 the Composite Schedule of Rates (CSR), or in the Bill of Quantities with Specified Unit Rates where applicable.

The above stated unit rate (s) and payments shall constitute full compensation for all materials, equipment, labour including all incidentals, necessary to complete the work.

Note: The above stated unit rate (s) shall deem to be inclusive of glazing, painting, fly proofing and iron mongery etc. No extra payment shall be made for such work.

25.6 Aluminium Doors and Windows

25.6.1 Description

The work covered under this section comprises of the following:

- a. Fixing in position aluminium doors and windows complete with handles, locks, nylon wheels, vinyl weather strips etc. as shown on the drawings and specified hereunder.
- b. Fixing glass of specified quality and thickness to windows and door.

25.6.2 General Requirements

25.6.2.1 Design Requirements

All doors, windows, railings, Handrails, etc. to comply with BS 4873 or equivalent standard in respect of materials, work sizes and manufacture. All sectional dimensions shown on drawings are only indicative. The Contractor shall be responsible to determine the adequacy of these with respect to actual structural and performance requirements. All extrusions shall be of adequate strength, not only to meet the structural performance, but also to minimize the risk of distortion in the finished surfaces.



Figure 25-1: Typical Aluminium Doors & Windows

25.6.2.2 Work Sizes

All dimensions given on drawings are between face of structural openings and/or between finished surface and allowances shall be made for variation due to constructional tolerances. The Contractor shall be responsible to measure actual final dimensions from the Site before fabrication of doors, windows and other assemblies/units.

25.6.2.3 Weather Tightness

Weather tightness and operations shall suit the weather conditions prevailing in the area of installation. All doors and windows will be fabricated as completely air and water tight units including gaskets for glazing, weather stripping, latches, locks, bolts for fixing etc.

25.6.2.4 Air Tightness

The fixed glazed windows shall be as far as possible 100% air tight under all weather conditions.

25.6.2.5 Air Infiltration

Air infiltration for opening windows and doors when fully closed shall not exceed 3m/hr/meter length of opening joint at a test pressure of 498 N/m when tested in accordance with B.S. 4315 part 1.

25.6.2.6 Acoustic Performance

Windows when installed shall provide an average sound reduction of 28 dB over a frequency range of 100-3150Hz.

25.6.3 Material Requirements

25.6.3.1 Aluminium Sections

All Aluminium doors and windows as shown on the drawings shall be fabricated with heavy duty high strength Aluminium extruded sections of Aluminium alloy 6063-TS. Conforming to B.S 1474-1972 and B.S. 1470-1972 Aluminium extrusions to be hard

colour anodized in dark bronze with an average anodic film thickness of 25 microns. The anodic treatment should conform to B.S. 3987:1974. Aluminium sections of ALCO, THERMEC CHAWLA or of approved equivalent make shall be used.

25.6.3.2 *Iron Mongery and Fittings*

Iron mongery, fittings, handles and locks shall be of bronze, stainless steel and Aluminium as shown on the drawings or given in the relevant item (s) of Chapter No. 25 of the Composite Schedule of Rates (CSR), or in the Bill of Quantities with Specified Unit Rates where applicable.

25.6.3.3 *Glazing*

The solar control float glass if specified shall conform to the latest revised B.S. 952. "First grade imported tinted bronze float glass shall be used subject to approval. The quality, kind, thickness and size of the glass shall be as shown on the drawings or given in the relevant item(s) of Chapter No. 25 the Composite Schedule of Rates (CSR), or in the Bill of Quantities with Specified Unit Rates where applicable.

25.6.3.4 *Sealants*

The external joints between the building openings, window frames etc. shall be formed to details shown on drawings and grooves shall be caulked with mastic sealants. External jointing sealants are to be suitable for the type and exposure of building. Material shall not be of a standard lower than one part polysulphide rubber sealant conforming to B.S 5215 and shall be applied strictly in accordance with the manufacturer's instructions. The colour and quality of sealant shall be subject to approval. Where joints to be sealed are deep the sealant must be supported by suitable polythene backing.

25.6.3.5 *Weather Stripping*

All opening section must be weather stripped with Neoprene glazing gaskets or similar approved and polypropylene pile weather stripping around doors to ensure adequate weather proofing. Aluminium glazing beads are to snap on type without visible fixing and must be adjustable to allow for varying thickness of glass. No PVC weather stripping is acceptable.

25.6.4 Submission of Samples

- a. The Contractor shall submit, for approval, samples of each type of door and window showing the quality of materials, workmanship and finish. The samples of iron mongery, fittings and fixtures shall also be got approved before purchases are made by the Contractor.

- b. The samples of glass for each type of glazing along with specifications of the manufacturer of special quality shall be submitted for approval before firm orders are placed for supplies.

25.6.5 Construction Requirements

- a. The Aluminium doors and windows shall be manufactured by an approved manufacturer.
- b. If required, the Contractor shall provide shop drawings based on Architectural drawings for the approval before orders are placed with the manufacturers.
- c. The manufacturer shall use the latest and approved method of jointing employed in the manufacture of high class work viz. mechanical jointing, reinforced with concealed welding shall be used in the manufacture of doors and windows.
- d. The workmanship of metal doors and windows shall conform to applicable provision of B.S. 990:1970 or equivalent standard.

25.6.5.1 Wind Pressure

- a. The Design wind speed to which the various elements of glazing and framing will be subjected to shall be calculated in accordance with B.S. CP-3 and the wind loads are to be taken = 125kg/m².
- b. All assemblies must be of appropriate shape, minimum 4mm thickness and sections, to enable them to resist the loads produced by repeated imposed wind pressures. The maximum deflection over clear span of any member shall be such that it does not induce cracking in glass panels and render the assembly unsafe. No member shall suffer any permanent deformation. No part of the work shall rattle during use.

25.6.5.2 Fixing

The fixing of doors and windows to concrete openings shall be carried out in an approved method as indicated in the drawings or as directed. Provision of necessary groove or rebate and holdfasts in the concrete shall be made in the form work and no holing or drilling shall be allowed in the exposed concrete finishes. These shall be erected in position after the building structure is completed and by using proper holdfasts as shown on drawings or counter sunk bolts and screws as directed in accordance with site requirements.

25.6.5.3 Handling

Care shall be taken in handling metal doors, windows, etc., during transportation and at site. These shall be stored under cover and shall be installed only by skilled mechanics, set plumb, level, in alignment and properly braced to prevent distortion.

25.6.5.4 Protection

- a. The joint between window and door frames and the building should be caulked with approved building mastic for total weather proofing.
- b. After installation, doors, and windows shall be protected from construction hazards that will interfere with their operation or damage their appearance or finish. They shall be cleaned on inside and outside of all mortar, plaster, paint or other foreign matter to present a neat appearance. Hardware and moving parts shall be lubricated.

25.6.6 Glazing

- a. The work of fixing glazing to doors, windows shall be carried out with the type and quality of glass specified for each door and window and as indicated in the drawings or as directed by the Engineer
- b. The glazing of "Antisun" float glass should be in accordance with the recommendations of BS CP 152:1972 and subsequent amendments or of equivalent standard.
- c. The sizes of glass indicated on the drawings are approximate only, and the actual sizes required shall be determined by measuring the frames to receive the glass. All glass shall be factory labelled on each pane and the label shall not be removed until finally approved.
- d. Glass will be fixed with best quality mastic compound of approved make suitable for the type of glass or with special bead or moulding as shown on the drawing or as directed. Special rubber lining and weather proof brush joints for sliding surfaces shall be provided where indicated.
- e. "Anti-sun" float glass shall be fixed using flexible compounds, sealants, performed strips or gaskets as per recommendation of the door/window manufacturer. The design shall allow for an edge clearance of at least 3mm all around unless any dimension exceeds 1500mm when the clearance shall be at least 5mm edge cover shall be adequate to retain the glass in position under the design wind loading.
- f. The rebate depth edge clearance plus edge cover shall not be less than 11mm (7/16") for 6mm glass. The width of the rebate platform must accommodate the glass, the front and back compound, and glazing bead. The bead depth should not be less than the rebate depth. Setting blocks, distance pieces, and location blocks shall be used as appropriate.
- g. Glass shall be protected against damage. After inspection, any labels, and paint spots shall be removed and glass shall be washed clean. Damages or broken glass shall be removed and replaced before acceptance at no extra expense. After the installation of 'Anitsun' float glass it shall be cleaned using a soft cloth with water and mild soap or liquid detergent, followed by rinsing with clean water and drying.

25.6.7 Measurement and Payment

25.6.7.1 Measurement

Payment for doors and windows will be made by measuring clear opening area in brick work or concrete in square feet (square meters).

25.6.7.2 Payment

Payments shall be made as per unit rate (s) for relevant item(s) given in Chapter No. 25 of the Composite Schedule of Rates (CSR), or in the Bill of Quantities with Specified Unit Rates where applicable.

The above stated unit rate (s) and payments shall cover the cost of furnishing all the materials labour, scaffoldings and appliances at Site and performing all operations in connection with their installation in accordance with instructions.

The above stated unit rate (s) for fixing doors and windows etc. shall include fixing of all finished hardware iron mongery fittings such as locks, peg stays, handles, push plates, kicking plates, door closers, glazing, flexible compounds, rubber lining and appliances at site and performing all operations in accordance with the drawings and specifications.

25.7 Miscellaneous Steel Work

25.7.1 General

The work covered shall include furnishing, fabricating and installing miscellaneous steel work including the following:

- Steel stairs.
- Steel Ladders.
- Pipe handrails.
- Steel protection angles.
- Steel doors, windows, gates, ventilators louvers.
- Steel fencing.
- Grating and chequered plate covering.
- Embedded plate, anchor bolts and other miscellaneous items.

Drawings, material, fabrication, surface preparation shall conform to the applicable requirements of section 13.4 above. Any proposed deviation due to field conditions and availability of local material shall be submitted to the Engineer for approval.

25.7.2 Steel Stairs

General: Structural steel stairs complete with grating treads or chequered plate treads, landings, supporting structures, hand rail, supports etc. shall be furnished and installed in accordance with working drawings. All components shall be galvanised to maximum extent practicable as shown on the drawings.

Material: Except otherwise indicated in the working drawings, materials shall conform to the requirements of ASTM A 36-63T (Tentative specifications for structural steel).

25.7.3 Steel Ladders

Steel ladder shall be welded assemblies with or without safety cages fabricated in accordance with the drawings. Material and standard of fabrication shall be the same as specified for stairs.

25.7.4 Steel pipe handrails

Steel pipe handrails consisting of posts, handrail, knee rails and toe rail shall be fabricated in suitable units having two posts or three posts in one unit with erection joints between handrail and knee rails.

Handrails of platforms galleries etc. of considerable length may not be shop fabricated as complete units consisting of posts etc. In case of such handrails the posts may be fabricated of the required height having one end with necessary arrangement for fixing to the platform or floor beams etc. and other end shop prepared to take the top handrail.

Top handrail, knee rail and tow rail may be brought at site in stock length. The same may then be cut and welded at site. Locally manufactured pipes, M.S or G.I may be used for the hand railing. These shall however conform to the requirements of ASTM A 53-65 or shall be of equivalent requirements.

25.7.5 Steel protection angles

Steel protection angles required for the protection of concrete work shall be erected true to line and level. Steel angles shall be fixed in position by using anchors.

25.7.6 Steel Door, Windows, Ventilators, Louvers and Gate Frames

Frames shall be fabricated form locally available hot rolled angle, tee channel or pipe sections as specified in the drawings. Material shall however conform to ASTM A 36.

Shutters: Shall be made of any of the sections noted above with skin plate of at least 18 S.W.G. as shown in the drawings.

Accessories such as hinges, anchors, bolts, locks and handles shall conform to the requirements shown on the drawings or as directed by the Engineer.

After fabrication one coat of zinc chromate or synthetic resin primer in a sight grey colour shall be applied.

25.7.7 Steel Fencing

Steel fencing shall be made from welded wire mesh bolted on the steel angles or channel frame as shown on the drawings or as directed by the Engineer.

25.7.8 Measurement & Payment of Structural Steel Work

25.7.8.1 General

Except otherwise specified herein or elsewhere in the relevant Contract Documents, no measurement and payment will be made for the under mentioned specified works related to the relevant items. The cost thereof shall be deemed to have been included in the quoted unit rate (s) of the respective items of Chapter No. 25 of the Composite Schedule of Rates (CSR), or of the Bill of Quantities with Specified Unit Rates where applicable.

25.7.8.2 Measurement

Measurement of work of structural steel for which the unit rate (s) are based on weight and for which detailed workshop drawing have not been made shall be measured net as installed at site as per sketches and instructions of the Engineer. After measurement the theoretical weight shall be calculated from standard tables of sections and weight in the manner followed in the preparation of Workshop drawings.

Measurement of works of structural steel for which the unit rates are based on weight and for which the detailed workshop drawings have been prepared, measurement shall be made at site to verify whether the items fabricated, supplied and erected in position are in conformity with the workshop drawings of the same and is to the satisfaction of the Engineer, the weights given in workshop drawing shall form basis for payment of bill. Any deviation found during the verification the same shall be checked from design and specifications point of view and shall be incorporated in the workshop drawing and consequently the weights shall be revised.

Measurement of acceptably completed works of all structural steel will be made on the basis of actual weight of structural steel fabricated, erected and installed in position as shown on the drawings or as directed by the Engineer.

25.7.8.3 Payment

Payments shall be made for the acceptable measured quantity as per unit rate (s) for relevant item(s) given in Chapter No. 25 of the Composite Schedule of Rates (CSR), or

in the Bill of Quantities with Specified Unit Rates where applicable, and these unit rate (s) shall constitute full compensation for all the work related to the above item (s).

25.7.9 Measurement and Payment of Steel Embedded Parts

25.7.9.1 Measurement

Measurement of acceptably completed works of steel embedded parts will be made on the basis of number of kg of steel parts provided and embedded in position as shown on the Drawings or as directed by the Engineer.

25.7.9.2 Payment

Payments shall be made for the acceptable measured quantity as per unit rate (s) for relevant item(s) given in Chapter No. 25 of the Composite Schedule of Rates (CSR), or in the Bill of Quantities with Specified Unit Rates where applicable, and these unit rate (s) shall constitute full compensation for all the work related to the above item (s).

25.7.10 Measurement and Payment of Powder Coated MS Trolley Guard

25.7.10.1 Measurement

Measurement of acceptably completed works of powder coated MS trolley guard (floor and wall mounted) will be made on the basis of actual length in running feet (meters) of MS trolley guard provided and embedded in position as shown on the Drawings or as directed by the Engineer.

25.7.10.2 Payment

Payments shall be made for the acceptable measured quantity as per unit rate (s) for relevant item(s) given in Chapter No. 25 of the Composite Schedule of Rates (CSR), or in the Bill of Quantities with Specified Unit Rates where applicable, and these unit rate (s) shall constitute full compensation for all the work related to the above item (s).

25.7.11 Measurement and Payment of Powder Coated MS Posts & Beams

25.7.11.1 Measurement

Measurement of acceptably completed works of powder coated NS posts and beams will be made on the basis of actual length in running meter of MS posts and beams provided and embedded in position as shown on the Drawings or as directed by the Engineer.

25.7.11.2 Payment

Payments shall be made for the acceptable measured quantity of the work as per unit rate (s) for relevant item(s) given in Chapter No. 25 of the Composite Schedule of

Rates (CSR), or in the Bill of Quantities with Specified Unit Rates where applicable, and these unit rate (s) shall constitute full compensation for all the work related to the above work.

The above stated unit rate (s) shall include furnishing of all plant, labour, equipment, appliances and materials and performing of all operations related to water proof treatment to foundations and basement structures complete in strict accordance with this section of the specifications and the applicable drawings and subject to the terms and conditions of the Contract.

Table of Contents

26	SUPPLY AND INSTALLATIONS OF SOLAR BASED PUMPING SYSTEMS, SOLAR BUILDINGS / HOME SYSTEMS, SOLAR STREET LIGHTS	3
	A - SPECIFICATIONS FOR SOLAR SYSTEMS-COMMON PART	3
	26.1 Solar Panels	3
	26.2 Cable & Wiring	5
	26.3 Panel Mounting & Structure	6
	26.4 Earthing / Grounding	7
	26.5 Batteries	8
	26.6 Gel Batteries	9
	26.7 Lead Carbon	9
	26.8 OPzV / OPzS Batteries	9
	26.9 Lithium Batteries (LiFePO4)	9
	26.10 Box / Stand for batteries, SHS-Inverter & Charge Controller	10
	26.11 LED Flood Light	10
	26.12 AC Energy Efficient LED Light Bulbs	11
	26.13 AC Energy Efficient Ceiling Fans	11
	26.14 DC Energy Efficient LED Light Bulbs	11
	26.15 DC Ceiling Fans	12
	26.16 DC Pedestal Fans	12
	26.17 Inverter Based Split AC	12
	26.18 PVC Channel Ducts & Pipes	12
	26.19 Flexible PVC Pipe	13
	26.20 Civil Work	13
	26.21 Reflective / Insulating Paint	13
	26.22 Warranty / After Sale Service	13
	B - SPECIFICATIONS FOR SOLAR PUMPING SYSTEMS	13
	26.23 Pump (Submersible)	13
	26.24 Motor	14
	26.25 Submersible Elate Electric Cable (4-Core)	16
	26.26 Column Pipe	16

26.27 Topset	17
26.28 Solar Pump Inverter / Controller	17
26.29 dV /dT or Sine Filters With Inverter (VFD)	18
26.30 System Design for Pumping System	19
26.31 Pressure Pumps (Up to 5.5 HP)	20
26.32 DC Solar Water Pump-Sets (up to 5.5 HP)	21
26.33 Solar Auto Tracker	21
26.34 PV Mounting Frame with Manual Trakering	22
26.35 Pre-Supply Testing & Inspection	22
26.36 Operation and Maintenance Manual	22
C - SPECIFICATIONS FOR SOLAR HOMES & BUILDING SYSTEMS	23
26.37 Grid Tie Inverter (ON-Grid without battery backup / Hybrid with battery backup)	23
26.38 OFF-Grid / Hybrid Inverter	24
D - SPECIFICATIONS FOR SOLAR STREET LIGHTS	25
26.39 Solar Street / Road Light System Design	25
26.40 LED Solar Road / Street Light Fixture	26
26.41 Solar Charge Controller (for Street / Road Lights)	27
26.42 Battery and Controller Box	28
26.43 Electric Cable	28

SUPPLY AND INSTALLATIONS OF SOLAR BASED PUMPING SYSTEMS, SOLAR BUILDINGS / HOME SYSTEMS, SOLAR STREET LIGHTS

A - SPECIFICATIONS FOR SOLAR SYSTEMS-COMMON PART

26.1 Solar Panels

- a. The PV module(s) shall contain mono crystalline silicon Grade-A Solar cells. (N-Type Mono PV Cell Modules and Bifacial Double Glass Modules due to its better performance will be given preference).
- b. The PV module should Work well with high-voltage input Inverters/ charge controllers (1000 Vdc).
- c. The PV Panel must have clear anodized aluminium frame with Anti-reflective, hydrophobic, low-iron Tempered cover glass.
- d. The Solar Modules shall meet the following valid IEC Standards or latest:
 - IEC 61215-1, IEC 61215-1-1, IEC 61215-2 :2016 (Design Qualification)
 - IEC61730-1:2016 (Safety - Requirements for construction)
 - IEC61730-2:2016 (Safety - Requirements for testing)
 - IEC TS-62804-1. (i.e.: TUV PPP-58042 or Equivalent) Anti-PID Certification.
 - IEC 61701 Salt Mist Corrosion Resistance Test (Latest)
 - IEC 62716 Ammonia Corrosion Resistance Test (Latest)
 - IEC 60068-2-68 Sand and Dust Erosion Resistance Test.
- e. Unique Serial number, Name / Logo of manufacturer and separate date of manufacturing (DD/MM/YYYY) should be laminated inside the module so as to be clearly visible from the front side.
- f. A properly laminated sticker containing the following details should be available at the back side of the module.
 - Name of the manufacturer / distinctive logo.
 - Model Name and Type of Cell Technology.
 - Peak Watt Rating (W_p) and Power Tolerance Range
 - Voltage (V_{mp}) and Current (I_{mp}) at STC
 - Open Circuit Voltage (V_{oc}) and Short Circuit Current (I_{sc})
 - Maximum System Voltage (V_{dc}) (i.e.: This should not be less than 1000 V_{dc})
 - Dimensions of PV Module
 - Test Standard(s) to which the module has been tested and certified.

- g. Following essential technical parameters of solar panel / modules should be provided with each panel supplied as well as in the technical proposal.
- I-V curve for the solar photovoltaic module/panel.
 - Date and year of obtaining IEC PV module standardization qualification certificate.
 - Electrical Data (i.e.: Pmax, Voc/Vmp, Isc/Imp at nominal Cell Operating Temperature (NOCT).
 - PV Module efficiency at STC.
 - Working temperature range of PV Module.
- h. Each panel should have factory equipped weather proof terminal junction box having at least IP67 protection with provision of opening for replacement of DC cables, blocking diodes and easy debugging if necessary.
- i. Limited performance guarantee: panel power, in standard conditions, will not be less than 90% of nominal power by the end of 10 years of operation and at least 80% at the end of 25 years of operation with 25-year limited power warranty.
- j. The PV Module should have at least 10-years warranty for any defects and efficiency as mentioned above. It should be provided On Stamp Paper Signed and Sealed by Contractor at the time of Handing / Taking Over.
- k. The PV Module should have at-least 17.50% Module efficiency with Positive Power Tolerance.
- l. The PV modules offered should not be more than 12 months old from the date of issue of work order.
- m. PV Module should have a Snow Load bearing of 5400 Pa and Wind Load Bearing of at least 2400 pa however if department deem appropriate may go for 3800 pa wind load depending upon their requirement.
- n. The Solar Module should be free from visual and cosmetics defects.
- o. The department/consultant on the expense of contractor/supplier shall verify Flash test reports with serial numbers from manufacturer for each panel (at the time of supply).
- p. All information regarding solar panel with above mentioned featured data should be accessible and verifiable online on the manufacturer website.
- q. IEC accredited lab test for solar panels is mandatory.
- r. EL (Electro-Luminous) test will be performed randomly for each individual project at the cost of contractor/supplier.

26.2 Cable & Wiring

- a. The AC / DC cables should be made of 99.9% copper strands and Flexible.
- b. From PV Panel to Junction Box, XLPE or XLPO insulated & XLPE/PVC Sheathed, UV stabilized single core, Double Insulated. Stranded /flexible cables (Conforming preferably to EN 50618 or IEC FDIS 62930) be used.
- c. From JB to Inverter, the DC cable must have Single Core, double insulated and suitable for minimum 1000 V_{DC} transmission.
- d. From Inverter to batteries, the DC cable can be single insulated, Single Core and suitable for minimum 300 V_{DC} transmission.
- e. DC circuit breakers (not fuse) of \geq Voc of String Voltage and suitable ampere rating (1.25 to 1.50 Times of Rated Current of all strings connected) must be installed between PV modules and controller / inverter.
- f. AC Circuit Breaker (s) of suitable rating (1.25 to 1.50 Times of connected Load) must be installed between Controller / inverter to Load and Grid to Controller / Inverter.
- g. AC / DC breakers should be marked with the manufacturer model number, rated voltage, ampere rating and batch/serial number.
- h. DC / AC breakers rating should be approved from Engineer In-charge before installation at site.
- i. To prevent solar panels from damage an appropriate size of DC Breaker / Fuse should be installed for each PV string and Surge Protection should be installed for combined Array (before Main DC Breaker / Inverter).
- j. DC Breaker, AC Breaker & Change overs should be placed in an enclosure. All Enclosures / Junction boxes should be made from Hot Dipped Galvanized Sheets of minimum 16 SWG.
- k. Cables shall be clearly labelled with essential electrical parameters including manufacturer name, Voltage Range, standards etc.
- l. All DC Wiring shall be aesthetically neat and clean, over all wiring/connection losses shall not exceed 1% of the total rated output power.
- m. All connections/ socket outlet among array, controller, inverters, batteries, and pumping set etc. must be made in junction boxes of adequate protection level.
- n. All wires/cables should be in standard flexible UV-Resistant conduits / HDPE of PN12, SDR 13.6, PE 100 for outdoor installation & (2-3 feet deep) for underground wiring / Cabling and PVC ducts for indoor installation.
- o. The DC Combiner Junction Box should be properly earthed including earthing of door as well.

- p. The DC Combiner should contain proper bus bars of adequate size each for Positive, Negative and Earthing.
- q. The Inverter Junction Box should be properly earthed as well as per vetted design of the Engineer in charge.
- r. All wiring should be in proper conduit of capping casing. Wire should not be hanging loose.
- s. All wires should be terminated properly by using lugs / thimble connectors / sleeves.
- t. Distribution board must be installed with proper screws.
- u. Electrical Hazards Safety Labels should be pasted on DC Combiner NFD Enclosure / Charge Controller / Battery Enclosures.
- v. Following lab tests are mandatory: Conductor resistance test, Insulation resistance test, Pressure test, Spark test.
- w. DC Cable from PV Module to Junction Box / Inverter for each string should be minimum size 6 mm².
- x. DC Cable sizing (For Pumping Schemes) from Junction Box to Inverter as per details below:

Sr.	Nos of Strings	Cable Size (mm ²)	Remarks
1	1	6	If Cable length is >200 ft. (One Sided) than cable size should also be increased accordingly.
2	2	10	
3	3	16	
4	4-5	25	
5	6-8	35	

26.3 Panel Mounting & Structure

- a. The panel mounting and structure should be made of hot dipped (80 microns Average) galvanized steel of minimum thickness of 12 SWG / 2.64 mm Channel / Pipe or 8 SWG / 4.06 mm Angle (Profile of channel and Sketch Attached for Reference).
- b. A sketch of the mounting frame (As per Actual Site Requirements) showing dimensions of the frame parts should be provided at the time of supply.
- c. PV to ground clearance must not be less than 1.5 feet. The height of the upper edge of the structure should not exceed 10 feet above the ground and 6 Feet for Roof Top Installations.
- d. To avoid Shading, Distance between two rows of PV panels and from walls should be maintained at a minimum of 1.6 times the height of structure/walls.

- e. The pit size for concrete works should be minimum 1.5x1.5x2 feet for each individual leg or 1.5x2.5x2 for double leg and the concrete should be extended at least 1 foot above the ground. The concrete ratio should be 1:2:4.
- f. The Surface azimuth angle of PV Module 180° and the Tilt angle (slope) of PV Module should be 33°.
- g. The PV modules will be mounted on metallic structures of adequate strength and appropriate design, which can withstand load of modules and high wind velocities up to 150 km per hour.
- h. Due to land Non-availability or any other problem, Structure design can be modified as per site requirement. Pole Mounted or manual Tracker Structure can be provided with the approval of Engineer In-charge.
- i. Array fasteners (nut/bolts/washers) between PV Module and Structure shall be stainless steel. Washers should be installed on both sides of Module frame.
- j. The minimum space between two PV Modules should be 2.54 cm (1 inch), to avoid air push over PV Modules.
- k. Mechanism / arrangement for cleaning of PV Panels should be provided. i.e. Space and ladder between panels or at the back side of structure, so that the operator can safely climb and clean the panels.
- l. All other array fasteners Structure shall be stainless steel or galvanized steel that provides the required mechanical strength.
- m. The PV modules will be mounted on metallic structures at the inner holes for cantilevered installation, which will evenly distribute the load of the panel around the support structure on both sides and in the middle.

26.4 Earthing / Grounding

- a. The PV Panel frame and structure should be connected by the shortest practical route to an adequate earth contact (of Less than 5 Ohms Resistance) as per requirement of equipment manufacturer and site earth conditions, using an uninterrupted conductor. Grounding can reduce the risks of damage from lightning-induced surges.
- b. The Sizing of Earthing conductor will be done as per NEC Table 250.122
- c. The grounding conductor should be 99% Copper and PVC insulated / Bare Copper if installed underground along a defined path where size & Design shall be approved from Engineer In-charge before installation at site.
- d. Motor, inverter, Battery / Battery Box (if required), Main Distribution Board should be connected to an adequate earth contact / Grounding.

- e. Ground enhancement material (GEM) shall be used below and above the Earthing plate for proper grounding. Gravel or coarse sand shall be pour along with soil in the pit.
- f. Grounding / Earthing plate should be made of Copper plate of 4mm thickness & Size minimum 1.0 x 1.0 Ft.
- g. Grounding / Earthing conductor should be connected to the plate / Rode / GI Pipe by proper connector of minimum depth of 6 feet.
- h. Alternatively Earthing Rod of suitable size and length can be installed. (Instead of Plate). If given / mentioned in the BOQ/Design and Engineer In-Charge Approval.
- i. All nut / bolt and Earthing clamp shall be stainless steel or galvanized steel.

26.5 Batteries

- a. The battery should be Deep Cycle, GEL, OPzV/OPzS, Lithium LiFePO4, Lead Carbon Type or equivalent. (Note: Battery type shall be specified in the bidding documents.)
- b. The battery must ensure safe and reliable operation in the whole range of ambient temperatures from -5°C to + 50°C.
- c. The maximum permissible self-discharge rate should not be more than 5 percent of rated capacity per month at 25°C.
- d. The battery shall have a certificate of compliances, issued by a recognized laboratory.
- e. The Batteries should have three years Comprehensive replacement warranty.
- f. The battery shall meet the requirements and recommendations given in IEC 61427, IEC 60896 21/22 (For VRLA) or equivalent. Lab Test Reports for battery cycle life should be provided.
- g. The Battery must support parallel connection to increase capacity in case of future expansion. Each Battery should have following minimum information printed on battery:
 - Model Number, Serial Number and Type of battery.
 - Rated Voltage and Capacity (AH) at discharge rate of 10 Hours.
 - Origin of made.
 - Manufacturer Name with distinct logo.
- h. The following information must be provided in the data sheet while submitting technical bid.
 - Certification/Test Standard(s) of the battery.
 - Information regarding cycles & self-discharge rate.

- i. In case of rechargeable battery bank (having more than one battery), the interconnection shall be made using lead plated copper bus bars or properly insulated flexible copper conductors.
- j. Battery disconnect switch / breaker of suitable size should be installed between batteries and inverter / charge controller.
- k. The Battery must have Low self-discharge rate, No memory effect and No gassing.

26.6 Gel Batteries

- a. Cycle life of the GEL battery (12V) before 80% capacity of Initial capacity must be minimum 1000 cycles @ 50% depth of discharge (DOD) at discharge rate of 10 Hours
- b. Cycle life of the GEL battery (2V Cell) before 80% capacity of Initial capacity must be minimum 1300 cycles @ 50% depth of discharge (DOD) at discharge rate of 10 Hours

26.7 Lead Carbon

- a. Cycle life of the Lead Carbon battery (12V) before 80% capacity of Initial capacity must be minimum 2000 cycles @ 50% depth of discharge (DOD) at discharge rate of 10 Hours.
- b. Cycle life of the Lead Carbon battery (2V) before 80% capacity of Initial Capacity must be minimum 2500 cycles @ 50% depth of discharge (DOD) at discharge rate of 10 Hours.

26.8 OPzV / OPzS Batteries

- a. Cycle life of the OPzV / OPzS battery (12V) before 80% capacity of Initial capacity must be minimum 2000 cycles @ 50% depth of discharge (DOD) at discharge rate of 10 Hours
- b. Cycle life of the OPzV / OPzS battery (2V Cell) before 80% capacity of Initial capacity must be minimum 2500 cycles @ 50% depth of discharge (DOD) at discharge rate of 10 Hours

26.9 Lithium Batteries (LiFePO₄)

- a. Cycle life of the Lithium LiFePO₄ battery before 80% capacity of Initial capacity must be minimum 5750 cycles @ 50% depth of discharge (DOD) at discharge rate of 10 Hours.

- b. The battery must have Integrated Battery Management System (BMS) to ensure battery safety and reliability.
- c. The BMS of the battery must have the following specifications:
 - Temperature protection
 - Over charge protection
 - Low voltage disconnect
 - High Voltage Disconnect
 - Short circuit alarm function
 - Self-balancing function
- d. The LiFePO4 Battery must have LED status and alarm indication.
- e. The charge and discharge rate of the battery must be designed at 0.2C minimum but capable of handling 0.5C charge and discharge currents.

Note: Product brochure, catalogue and certificates must be attached with the Technical Bid.

26.10 Box / Stand for batteries, SHS-Inverter & Charge Controller

- a. The batteries should be housed in a vented compartment/stand that prevents users from coming in contact with battery terminals. This compartment/stand should be strong enough to accommodate the weight of the battery.
- b. A mechanism to prevent opening and entry of the battery should be provided.
- c. This compartment should be manufactured of mild steel of at least 18 SWG.
- d. The compartment should be powder coated paint.
- e. The entire enclosure/stand must be constructed to last at least twenty years without maintenance and should be protected against corrosion. The enclosure should have a clean and neat appearance. Battery Box /stand should be installed at a place in accordance with user's preference

26.11 LED Flood Light

- a. Solar Based LEDs/ Light fixtures shall conform to the latest IEC/ISO internationally recognized standards.
- b. LEDs/Light fixtures should not be Chip-on-board (COB) single chip type due to their poor heat dissipation.
- c. LEDs/ Light fixtures shall be modular type with proper heat sinks.
- d. Solar based lights (LED fixtures etc.) should provide at least 100 Lumen/watt.
- e. The Colour Rendering Index (CRI) must be equal or greater than 70

- f. LEDs/Light fixtures should be designed to deliver at least 10 years of service.
- g. Complete lightening unit shall be weather proof (Protection Class IP65).
- h. The output from the LEDs/Light fixtures should be constant throughout the duty cycle.

26.12 AC Energy Efficient LED Light Bulbs

Shape	Cap / Fitting / Base Type	Colour	Lumens Per Watt	Colour Temperature	Colour rendering index (CRI)	Life Time of Lamp (Hours)	Power Factor & Rated Voltage
Globe	E27	Cool or Warm White	Min 100W	2700K / 6500K	70	10,000	≥ 0.70 & 220 Vac

Note: LED Light Bulbs should be marked with the manufacturer model number, rated voltage, Wattage

26.13 AC Energy Efficient Ceiling Fans

Sweep		Rated Power	Speed			
Inches	MM	Watts	Rpm			
56	1400	50 Max	≥ 320			

- a. 10% + in Power Consumption is Allowed as per PSQCA Standard
- b. Rated Voltage: 230 V~ (±10V)
- c. Rated Frequency: 50 Hz
- d. Insulation Class: 155 (F) or better
- e. Motor Core: Electrical Steel Sheet
- f. Winding Wire: 99.99% Super Enamelled Copper CA Wire or 99.99% Pure Copper Wire.

Note: Energy efficient fan should be marked with the manufacturer model number, rated voltage, and wattage.

26.14 DC Energy Efficient LED Light Bulbs

- a. The LED lamps must have luminous efficacy of at least 80 lm/W (at 25°C ambient temperature).
- b. The LED lamp must be protected against reversed polarity of the operation voltage.
- c. Base shall be an E-27 thread type.

- d. The emitted light shall be cool or warm white.
- e. The wide angle shall be between 120° to 125°.
- f. Operating Voltage 12Vdc / 24Vdc
- g. Lamps should be marked with the manufacturer model number, rated voltage, wattage and date of manufacture or batch number.

26.15 DC Ceiling Fans

Sweep	Rated Power	Speed	Service Value	Operating Voltage
Inches	Watts	Rpm	Air Delivery/W	V
48 (with Speed Control) Metal Blades	30-36	> =320 RPM	9.54	12/24

26.16 DC Pedestal Fans

Sweep	Rated Power	Speed	Service Value	Operating Voltage
Inches	Watts	Rpm	Air Delivery/W	V
18 Inch (with Speed Control)	18-30 W	1250 RPM (Full Speed)	5.22	12/24

26.17 Inverter Based Split AC

Inverter based AC with both heating and cooling option.

Sr.	Description	Unit	Details
1	Compressor	Type	Multistage Rotary
2	Noise Level (Indoor)	Db (Max)	≤ 50
3	Voltage Range	Volts (Min & Max)	180 to 250 Vac

26.18 PVC Channel Ducts & Pipes

- a. A product of good quality standard material standardized by the provincial standardization committee with suitable size to be provided / used, as per direction/approval of Engineer In-charge.
- b. Ducting must be done with proper steel nails and clips.
- c. All ducting (wiring) must be align.

26.19 Flexible PVC Pipe

- a. The flexible PVC pipe should be of good quality material standardized by the provincial standardization committee with suitable size to be provided / used, as per direction/approval of Engineer In-charge.

26.20 Civil Work

The following Civil Works should be carried out for ground installation of SPV Modules/mounting structures.

- a. Minor Cutting and clearing of trees/plantation to avoid shadows.
- b. Civil work for earthing system as per the statutory requirements.

26.21 Reflective / Insulating Paint

The Roof Paint should be ultra-white, high reflective, 100% acrylic elastomeric roof sealer designed for fixing leaks in roofs the paint should contain heat reflective pigments and additives that provide an excellent, highly protective barrier which reflects the sun's heat and destructive UV rays leaves a brilliant ultra-white finish, reducing surface heat absorption up 20°F.

The Reflective paint should comply with ASTM D6083, Fiber Reinforced for more protection, strength and durability which allows for contraction and expansion, Resists surface fungal growth.

26.22 Warranty / After Sale Service

Three years Comprehensive Free Replacement, Repair and maintenance Warranty at site (Free of Cost) should be provided for all the components of Solar System. (if not mentioned separately otherwise).

B - SPECIFICATIONS FOR SOLAR PUMPING SYSTEMS**26.23 Pump (Submersible)**

Pump should be supplied having standard 150-9906 specifications. The pump must be submersible, made of stainless steel. The characteristic curves (Original from Manufacturer) showing the efficiency at duty point and performance of the pump should be provided in the technical proposal and also at the time of pre-supply testing. The quoted pump should be tested for its performance and certified as per 150-9906 standard. The pump should be suitable for installation and operation in tube wells/dug wells/open well with clear water discharge. Pump shall comprise of bowl assembly and

non-return valve as integral part of pump's parts. Pump and motor shall rigidly couple through NEMA standard coupling. The stage casings of pumps should be connected as per NEMA / ANSI / AWWA / ASTM / BSS standard. Each stage casing must have replaceable wear ring. The impellers shall be secured to the pump shaft with tapered conical sleeves pressed into the taper bore of impeller or impeller secured through chrome plated stainless steel hexagonal sleeves. Suction casing must be between pump and motor with suction strainer as protection of pump against coarse impurities of the liquid handled.

Specification for main components of the pumps

Sr.	Components	Specifications
1	Casing/Diffuser	The Casing/Diffuser should be in fabricated stainless steel AISI 304/316
2	Impellers	Stainless steel AISI 304 / 316
3	Driving Shaft	Stainless steel 304/420/316
4	Sleeves	Stainless steel AISI 329/ 304 / 316
5	Gaskets	Rubber Gaskets
6	Bearings	AISI 329 stainless steel
7	Coupling & Screen + Cable Guard	Stainless steel AISI 316/319/304/420
8	Non-Return Valve / Sluice Valve	As per British standard specifications (BSS), Minimum PN16 (16 Bar) or Above (As Per Site Requirements) PN Value / Bar Capacity of Valves must be more than Installed Pump Max/Shut-off Head Minus Static Water Level of Bore. (Leakages in Valves are NOT Acceptable).
9	Pressure Gauge	As per British standard specifications (BSS), having PSI or Bar scale (4 Inch Size), Liquid Filled, minimum 350 PSI Range, Looped Siphon tube Pipe, Stainless Steel / polypropylene Casing.
10	Clamps	Steel - Pressed
11	Pump Efficiency	Minimum efficiency of the pump (For discharge of 3000 GPH and more) should be 70% ensured at duty point. (Duty Point of the Pump be preferably selected at the peak efficiency point or (Within $\pm 10\%$ of discharge) of Pump Peak efficiency Point)

26.24 Motor

The winding material should be 99.99% copper. The motor should have wet type, water cool rewind-able/repairable stator. The motor should have non-disposable/non-hermetically sealed winding. The insulation class of the winding material should be mentioned. For each model quoted, all the technical parameters such as rated voltage, power factor, efficiency, full load ampere, speed and other similar parameters should be provided at the time of pre-supply testing. The testing report with all basic parameters should also be provided at the time of pre-supply testing. The motor shall be

manufactured in compliance with National Electrical Manufacturer Association (NEMA) standards. The motor shall be three-phase submersible and shall be capable of operating at rated voltage of 380 Volts at 50 Hz. The motor should be capable of operating with variable speed through V/F control. Winding of the motor shall of rewind able type with class - IC40 insulation and IP68 protection. The synchronous speed should be 2850-2950 RPM. Motor shall be capable of operating in well water with temperature normally start from 40°C. Motor should be designed for continuous operation. Motor must be filled with water without any chemical additives hazards to health for cooling. The motor must be properly protected against the entry of well water sand etc by double mechanical seal one is rotating and other stationary and must be made of Silicon carbide/ Tungsten carbide and must be protected with sand protection guards. All supports shall be high grade cast iron and stator outer side jacket body should be in stainless steel in AISI 304. The excessive pressure due to heating up of the filled water must be compensated by a pressure equalizing rubber diaphragm in the lower part of the motor. The axial thrust of the pump shall be countered by oscillating sliding block type thrust bearing. The thrust bearing of the motor should be able to bear a down load thrust force from the water pump and the upward thrust force produced while starting the water pump. Motor in open well / water tank should be installed with cooling jacket / shroud / sleeve and when motor is installed in bore then installing of cooling jacket is also required. Motor shall be capable of maximum of 20 starts in an hour. Motor efficiency of motors 7.5 HP and above should not be less than 75% at Full Load and Motor Rated Voltage.

**Technical specification of rewind-able wet stators, three phase squirrel cage
water filled submersible motor**

Sr.	Components	Specifications
1	Winding	Made of pure electrolyte copper and the winding insulation should be suitable for > 1000 Volts and must full fill resistant tests range.
2	Stator	Energy efficient low-losses electrical magnetic sheet should be fixed in stainless steel casing. M800 or M600 magnetic sheet are preferable to use.
3	Rotor	Energy efficient low-losses electrical magnetic sheet fixed with high grade copper bars. M800 or M600 magnetic sheets are preferable to use.
4	Spline Shaft	AISI 420 stainless steel, flange dimension according to NEMA standard, over size design to ensure stiffness in severs condition.
5	Shaft bearing	Water lubricated guide/general bearings fixed in upper and lower brackets should be made of metal impregnated carbon.
6	Lower thrust bearing	Thrust sliding block bearings, self-aligning Mitchell type, should be able withstand 20000N axial load
7	Mechanical Seal (Stationary & Rotary)	Silicon carbide or tungsten carbide mechanical seal.
8	Cooling filling fluid	Water mixed with non-toxic anti-freeze provide

Sr.	Components	Specifications
		cooling and lubrication also protect and prevent inside parts from corrosion.
9	Degree of protection	IP68
10	Insulation Class	Insulation Class B (130°C) NEMA Insulation Class F (155°C) NEMA or above will be given preference.
11	Voltage Tolerance	+6% to -10%
12	Mounting position	Capable of both Vertical or horizontal Installation
13	Class	IC40
14	Maximum Immersion	150 Meters
15	Starting per hour	20

26.25 Submersible Elate Electric Cable (4-Core)

The Submersible cable (4-Core) should be made of 99.9% copper strands with double PVC insulation for 1000Vac, should be adequately flexible and environment friendly. Stranded and flexible insulated copper wires and cables must be used for all outdoor and indoor installations. The wiring that leads into the building shall be protected in a conduit. The cable must have undergone quality tests as per BSS standards. Cable size should be selected so that the Voltage drop Losses in the drop cable should not be more than 2.5%. Following lab tests are mandatory.

- Conductor resistance test.
- Insulation resistance test.
- Pressure test.
- Spark test.
- Note: The Supplier should provide the quality tests certificates at the time of pre-supply testing and inspection.

26.26 Column Pipe

The column pipe shall be flanged ERW steel pipes conforming to ASTM designation A-53 with a minimum thickness of 3.6 / 4.0 mm (3.6 mm for pipes up to 2.5" dia and 4 mm for pipes above 2.5" dial and shall be painted with corrosion resistance paint of suitable thickness. Flanges thickness of 19-20 mm shall have grooves for cable passage. Each column pipe shall be complete with gaskets, bolts/studs, washers and nuts. All nuts, bolts, and washers shall be made of minimum A2 grade stainless steel.

The column pipe shall be supplied in interchangeable section having an approximate length of 10 feet column pipe shall be flanged perpendicular to the axis of pipe.

Column pipe size should be selected so that the Head Losses in the column pipe should not be more than 5%.

For Reference a table-1 is given below.

HDPE Pipe of ≥ 0.75 Inch diameter, SDR 13.6, PE 100, conforming to ASTM F-2160 Standard without Joints to be installed/ included along with and equal to Column pipe for confirming Water Level testing purpose.

Features

- Manufacturer's pipes should meet international standards like BSEN 10255 & ASTM A 53
- Dimensional accuracy circularity and plan end cut should be observed,
- Weld strength of pipe and mechanical properties or raw material should be tested as per manufacturing standards.
- Pipes should be NDT tested (Non-destructive - Eddy current)
- Pipes should be hydrostatically pressure as per manufacturing standard.
- Pipes should be gone through straightening process to remove bendiness.

26.27 Topset

Top set shall comprise of Bore covers plate, (covering bore hole completely and securely), installation/suspension clamps (2-Nos), sluice valve (BSS/ASTM), reflex valve (BSS/ASTM), Washout Valve approx. 3-4 feet above the ground (T-Connection For Testing Pump's discharge), connector and cable jointing material (Cable connection from motor to switching device shall be joint free), Liquid Filled Pressure gauge minimum 4 Inch diameter suitable / appropriate for the required head pressure and cable ties. Bore Cover Plate should have provision for water level testing facility (i.e: Hole for Sonic Water Level Meter / HDPE Pipe insertion)

For Cleaning of solar Panels, Plastic pressure pipe should be provided of suitable length to reach the furthest / last Solar Panel.

Every Water Supply Scheme should have a non-removable name plate fitted at suitable place / box having essential information and bearing the name of supplier, Consultant and client.

26.28 Solar Pump Inverter / Controller

- a. The solar pump inverter/controller should have built-in advance version of Auto MPPT controller, over load protection, Soft start/Soft Stop Features and Variable Frequency Drive (VFD) with integrated Gate Bipolar Transistors (IGBTs) of European, USA or Japanese origin or atleast equivalent.
- b. The make and origin of the inverter/controller should be clearly mentioned in the catalogue and submitted in the technical proposal.
- c. The inverter offered should comply to or Equivalent standards:

- CE/RoHS
 - Low Voltage Directive 2014/35/EU
 - EMC Directive 2014/30/EU
 - IEC 62109-1 (Safety of Power Converters for use in PV Systems)
- d. The complete datasheet showing all the electrical parameters like input & output voltage ranges should be provided in the technical bid.
- e. All the electrical parameters like input & output voltage ranges, and efficiency should be provided at the time of pre-supply testing and inspection.
- f. Efficiency of inverter should be 96% and above at Rated Capacity.
- g. Efficiency of MPPT should be 98% and above.
- h. The inverter < 25kW Ingress protection of inverter must be minimum IP 65 Rating or above and for inverter \geq 25kW ingress protection of inverter / enclosure will be minimum IP 54 Rating or above.
- i. Inverter / Controller having the capability to run both on AC and DC Power would be given preference.
- j. Inverter should have at least three (3) years product and performance warranty.
- k. The Pump Controller / Inverter should have an ON/OFF Switch/Button to Start and Stop the Pump.
- l. Inverter should have active RS232/485 etc. communication port available, the Data available, through this port can be used for Remote Monitoring.
- m. Inverter circuit must include protection against:
- Over or Low voltages and currents beyond critical level of the inverters circuits.
 - Protection against accidental short circuits & reverse polarity connections.
 - Protection against lightning induced transients.
 - Over load protection.
 - Low RPM Protection (i.e.: Frequency < 30 Hz or as per pump characteristic curve) Motor Should Stop.
 - Dry run protection. (PF / Current Based).

26.29 dV /dT or Sine Filters With Inverter (VFD)

- a. The use of load reactors increases the reliability, performance, and efficiency of VFD systems, extends the life of both drives and motors, and reduces the amount of energy consumed by the motor/drive system.

- b. Output dV/dT or Sine Filters (between VFD and Motor) of appropriate size (for 3-phase $\geq 380\text{Vac}$ Motor of Class B Insulation) should be used where the cable length between motor and inverter is more than Fifty (50) Feet or as advised / recommended by the inverter manufacturer in their Technical Documentation. For cable lengths of more than 150 meters sine filters should be used.
- c. Filter should be enclosed in a vented box.
- d. Filter Efficiency should be minimum 97%.
- e. Filter should have a current rating of equal or greater than Motor FLA Rated Current.
- f. Distance between filter and pumping inverter should not be more than 2 meters.
- g. Motors with Insulation Class F, H or above are exempted from the requirement of dV /dT Filter.

26.30 System Design for Pumping System

- a. Suitable factor of safety should be applied while designing the system in order to have compensations for variations in irradiations.
- b. For Fix Structure and Auto Tracker, the PV panel peak power at STC (Wp) should be 75% more than the Motor basic input power (PV Loss Compensation Factor = 1.75).
- c. For Auto /Manual Tracker, the PV panel peak power at STC (Wp) should be 50% more than the Motor basic input power (PV Loss Compensation Factor = 1.5) as per direction of Engineer In-charge
- d. If Single Axis Auto Tracker Structure is installed on the above factor, then daily operational timings of pumping can be increased by 10-20%, as compared to fixed structure installation.
- e. Total PV Power (Wp) (Imperial Gallons) =
$$\frac{Q \text{ (iGPH)} * \text{TDH (ft)} * 746 * \text{PV Loss Factor}}{60 * 3300 * \eta_{\text{pump}} * \eta_{\text{motor}}}$$
- f. Total PV Power (Wp) (US-Gallons) =
$$\frac{Q \text{ (US-GPH)} * \text{TDH (ft)} * 746 * \text{PV Loss Factor}}{60 * 3960 * \eta_{\text{pump}} * \eta_{\text{motor}}}$$
- g. Total PV Power (Wp) (Metric Units) =
$$\frac{Q \text{ (m}^3\text{/hr)} * \text{TDH (m)} * 9.81 * 1000 * \text{PV Loss Factor}}{3600 * \eta_{\text{pump}} * \eta_{\text{motor}}}$$
- h. Voltage (V_{mp}) of Each String of PV Panels should be as per details given below and String Voltage (V_{mp}) should be within the MPPT range of Inverter.
 - For 380 V_{ac} 3-Phase Motor = $380 * 1.414 * 1.06 = 570$ Vdc String, minimum
 - For 220 V_{ac} 3-Phase Motor = $220 * 1.414 = 310$ Vdc String.

- Small Inverters (i.e.: 3-Phase, 220 Vac) with voltage boost function are exempted from the above string voltage requirements. String can be made as per boost Inverter Controller recommended String DC Voltage and should not be less than 230Vdc in any case.
- i. Details of each PV Panel string should be submitted in Technical proposal (i.e.: Nos of total strings and Nos of PV panels in each string along with wattage and V_{mp} of each PV panel).
- j. Unjustified Oversizing in PV Panels Wattage is not allowed.
- k. To avoid any oversizing, all commercially available PV Panels should be considered.
- l. Solar Pump Inverter should have a kW capacity equal or greater than the Motor Rated Input Power.
- m. Solar Pump Inverter / Controller Size (kW) \geq (Motor Rated Power in kW / Motor Efficiency).
- n. Solar Pump Inverter / Controller should have a current rating of 1.15 Times (minimum) of Motor FLA Rated Current.
- o. Motor should not be loaded more than 90%. (i.e.: Design / Calculated BHP should not be more than 90% of Motor Rated Horse Power)
- p. Along with this specification, contractors should also follow manufacturer's recommendations for all major components of Solar Pumping System.
- q. Requirement of Efficiency for Motor i.e. 75% will not apply on Motors smaller than or equal to 5.5HP and the requirement of efficiency for pump i.e. 70% will not apply on pumps having discharge equal to or lower than 3000 GPH.

26.31 Pressure Pumps (Up to 5.5 HP)

- a. Submersible pump conforming to ISO-9906 Standard.
- b. Pump + AC Motor (3-Phase-220V /380V) or DC Motor and Pump with Display Unit.
- c. Solar pump inverter/controller should be MPPT based and Minimum Ingress Protection of IP65.
- d. In case, where the column pipe diameter is less than or equal to 1.5-inch (For discharge equal or less than 6000 LPH and/or for Motor 4 HP and below), HDPE pipe of at least PN12 / SDR 13.6 / PE100 (For TDH of equal or less than 300 ft.) without joint may be used instead of MS pipe for better economics and to avoid hydraulic losses. However stainless steel rope of minimum diameter of 6 mm (28 mm²) for suspension of pump-set must be supplied with HDPE pipe. (Note: For TDH of more than 300 ft., HDPE Pipe type / thickness may be increased/changed accordingly)

- e. Top set shall comprise of Suitable Galvanized stand (Design should be verified from Engineer In-Charge before start of work)
- f. For Pressure Pumps ≤ 5.5 HP schemes, Solar Module efficiency requirement is minimum 16%. (Only for Cut Cells PV Modules or Cell Size of 5 Inches PV Modules).
- g. Connection to overhead water storage tank. Top bend, S.S Fasteners & Erection clamps.
- h. Civil work to protect borehole i/e foundation.
- i. The pump should operate safely with Sand particles up to (50) gram/m³.

26.32 DC Solar Water Pump-Sets (up to 5.5 HP)

- a. DC Motor can also be provided for Equal or less than 5.5 HP.
- b. Motor should be capable of both AC and DC operation. There must be auto power source recognition feature.
- c. The motor should be brushless, permanent magnet type.
- d. The Controller must have a display Unit, showing all essential parameters (i.e.: Current, Voltage etc.).
- e. The Controller must be of MPPT type. MPPT efficiency should be equal or more than 98%
- f. Pump should have auto and soft start / stop feature.
- g. The pump-set should have following protections
 - Dry Running Protection
 - Reverse Polarity Protection
 - Over phase protection
 - Over Head Protection
 - Lose Phase Protection
 - Electronic Protection
 - Over Current/ Overload Protection

26.33 Solar Auto Tracker

- a. The solar tracker offered should be fully automatic and intelligent, and must be capable of Single axis tracking (from east to West) and should have its own power supply (PV Panel, Battery and Charge Controllers) other than PV Panel used for Pumping Setup.

- b. Individual Auto-Tracker should be ≥ 4 kW each and Tracking Accuracy should be within $\pm 5^\circ$.
- c. The auto Tracker should also have manual control mode to adjust the tracking angle manually. Structure Material Should be Hot Dipped Galvanized Steel (Minimum 80 Microns).
- d. All nuts, bolts, washers and other fasteners for mounting structure shall be made of minimum A2 grade stainless steel.
- e. Foundation and other details will be separately provided.
- f. Three years Comprehensive Free Replacement, Repair and maintenance Warranty (Free of Cost) should be provided for all the components of auto Tracker (including Batteries).

26.34 PV Mounting Frame with Manual Trakering

Suitable for 2.5 or 3.5 KW PV Panels easily movable in multi directions having flanges with bearing balls $\frac{1}{2}$ " and having angle adjustment. Base steel cage $\frac{3}{4}$ ", MS rod 3.5 feet length with nut-bolts system for strong anchoring. Pillar pipe 6 mm with 5.5" dia, base plate 15"x15"x $\frac{1}{2}$ " size with 04 numbers of supports. Support for PV, 5 mm thickness 4" dia pipe and 24"x12"x $\frac{1}{4}$ " side plates. MS Angle side bracing 2"x 2" x $\frac{1}{4}$ ". MS Angle frame 2"x 2" x $\frac{1}{4}$ " for panel mounting. Steel structures/frames shall be powder coated. Galvanized nuts, bolts and washers for tracker fitting. Steel frame shall be properly designed and shall withstand wind speed/load of at least 130 km/hr and tough weather condition.

26.35 Pre-Supply Testing & Inspection

The firm applying for the tender has to provide the recent test bed reports from the pump/motor manufacturer or any other third party as per ISO-9906 standard. Each of the offered pump set models must undergo these test prior to supply and installation, In order to ensure the quality and standard of the equipment contractor may be asked to provide test result conducted by third party for re-verification.

26.36 Operation and Maintenance Manual

An Operation and Maintenance Manual, in English and Urdu language, should be prepared and provided by the contractor with the solar PV pumping system. The Manual should have information about solar energy, photovoltaic, modules, DC/AC motor pump set, tracking system (if any), mounting structures, electronics and switches. It should also have clear instructions about mounting of PV module, DO's and DONT's and on regular maintenance and Trouble Shooting of the pumping system. Name and

address of the person or Centre to be contacted in case of failure or complaint should also be provided.

C - SPECIFICATIONS FOR SOLAR HOMES & BUILDING SYSTEMS

26.37 Grid Tie Inverter (ON-Grid without battery backup / Hybrid with battery backup)

1. UL-1741 Certified or IEC 62109-1 and IEC 62109-2 or Equivalent Certificates.
2. Minimum 95% Conversion Efficiency at Rated Capacity (High Frequency Inverters).
3. Minimum 87% Efficiency for Transformer based inverters (Low frequency Inverters).
4. The inverter should have built-in MPPT controller
5. The Priority of the inverter should be set that load will be running from the solar energy then Grid and in the end will be running from the Battery Backup.
6. Inverter (Hybrid Only) must be capable of configuring for Charging GEL, Lead Carbon, OPzV/OPzS Batteries and Lithium Iron Phosphate batteries (LiFePO₄).
7. Hybrid Inverter (If Quoted along with Lithium Batteries) must be capable of communication with the BMS of Lithium Batteries.
8. Rated output voltage of inverter / Controller shall be pure sine wave AC.
9. Total harmonic distortion (THD) in AC output should not exceed 3% at rated capacity.
10. The degree of protection of the ON-Grid inverter Installation should be IP-65 rated and for indoor Hybrid Inverter installation, the IP rating should be IP-20 or above.
11. Wide input voltage range capability. (i.e.: Voltage Range can be adjustable / selectable)
12. Natural convection cooling for maximum reliability
13. Outdoor enclosure for unrestricted use under any environmental conditions
14. Capability to connect external sensors for monitoring environmental conditions.
15. The output of the inverter must synchronize automatically its AC output to the exact AC voltage and frequency of the grid.
16. The Inverter should have the capability of Parallel operation up to three units. (Only For projects, where more than one inverter should be installed).
17. Inverter should have active RS232/485 etc. communication port, the Data available through this port can be used for Remote Monitoring.

18. Liquid crystal display should at least be provided on the inverters front panel or on separate data logging/display device to display following:
 - a. DC Input Voltage
 - b. DC Input current
 - c. AC Power output (kW)
 - d. Current time and date
 - e. Temperatures (C)
 - f. Converter status
19. Inverter circuit must include protection against:
 - Over or Low voltages and currents beyond critical level of the inverters circuits.
 - Protection against accidental short circuits.
 - Protection against lightning induced transients.
 - Over load protection.

26.38 OFF-Grid / Hybrid Inverter

1. The Inverter must be pure sine wave output suitable for 220 Volt, 50 Hz.
2. Inverter must be capable of configuring for Charging GEL, Lead Carbon, OPzV / OPzS Batteries and Lithium Iron Phosphate batteries (LiFePO₄).
3. The Inverter / system must have a MPPT Solar Charge Controller.
4. Minimum 92% Conversion Efficiency at Rated Capacity (High Frequency Inverters).
5. Minimum 87% Efficiency for Transformer based inverters (Low frequency Inverters).
6. Total harmonic distortion (THD) in AC output should not exceed 3% at rated capacity.
7. The inverter must be user programmable for selecting PV, Grid and Battery Priority as well as Built-in programmed and user defined voltage and current settings of the charge controller for GEL, Lead Carbon, OPzV / OPzS batteries and Lithium Iron Phosphate batteries (LiFePO₄).
8. The Inverter must have Protective function limits for:
 - a. AC under voltage protection
 - b. AC over voltage protection
 - c. Battery under voltage Alarm
 - d. Low Voltage Disconnect

- e. High Voltage Disconnect
 - f. Overload and Short Circuit Protection
 - g. Over Temperature Protection
9. The inverter must be ISO 9001, ISO 14001 and CE Certified.
 10. The inverter must have IEC 62109-1 and IEC 62109-2, or Equivalent Certificates.
 11. The degree of protection of the outdoor inverter Installation should be IP-55 rated and for indoor Inverter installation, the IP rating should be IP-20 or above.
 12. Wide input voltage range capability.
 13. Inverter should have active RS232/485 etc. communication port, the Data available through this port can be used for Remote Monitoring.
 14. Inverter (If Quoted along with Lithium Batteries) must be capable of communication with the BMS of Lithium Batteries.

Note: Product Brochure, Catalogue and certificates must be attached with the Technical Bid.

D - SPECIFICATIONS FOR SOLAR STREET LIGHTS

26.39 Solar Street / Road Light System Design

- a. Assessment of Wattage of the LED Luminaire, Pole Height, Pole thickness, Pole top diameter, Pole base diameter, Base plate size, Base Plate thickness, Stiffener size, Stiffener thickness, Pole arm design, Pole Arm Length, Pole arm thickness, Pole arm diameter, Pole arm Placement / Fixing position, RCC foundation size, Anchor / J-bolt size, Steel Rebars cage (Mesh) and Number of Poles (Pole to Pole distance) should be according to the design provided / approved by the Engineer In-charge.
- b. Round Conical or Octagonal Hot Dipped Galvanized Pole of average 80 Microns should be installed.
- c. All Nuts, Bolts and Washers should be stainless steel.
- d. Pole base plate should be tightened in between two stainless steel nuts and washers (one nut and washer at upper and one nut and washer at lower side of the base plate).
- e. All Anchor / J-bolt shall be in level and align to each other.
- f. All Anchor / J-bolt shall be galvanized.
- g. All Anchor / J-bolt shall have at least 150 mm minimum threads.
- h. All poles shall be installed on levelling nuts secured to the anchor bolts and with locking nuts on the top of the base flange.

- i. The concrete ratio should be 1:2:4 for RCC foundation.
- j. Proper sketches of Pole, base plate, RCC Foundation and Steel Rebars cage (Mesh) should be provided and approved from Engineer In-charge.
- k. In order to focus on winter sun availability and Easy cleaning of Solar panel from dust etc. with Rain water, Solar Panels should be installed at 180° Azimuth Angle and the Tilt angle (slope) of PV Module should be between 45° ±5° (Only for Solar Street Lights).

26.40 LED Solar Road / Street Light Fixture

1. LED Efficacy must be greater than or equal to 130 Lumens/Watt.
2. The fixture must be IP-66 Rated or above.
3. The Colour temperature of the LED should be Pure white in the range of 5000-6000 K.
4. The LED Light distribution must be IESNA Type-II
5. The LED must be suitable for working Temperature from -40 ~ + 60°C with relative humidity of 15% ~ 90%
6. The Colour rendering Index (CRI) must be equal or greater than 70.
7. The LED Light Fixture must be LM79 and LM80 Tested.
8. LEDs/Light fixtures should not be Chip-on-board (COB) single chip type due to their poor heat dissipation.
9. LEDs/Light fixtures shall be modular type with proper heat sinks.
10. The output from the LEDs/Light fixtures should be constant throughout the duty cycle
11. LED Life should be greater or equal to than 50,000 Hours.
12. The LED Light Fixture must have the following certification:
 - ISO 9001
 - ISO 14001
 - CE (EMC and LVD) Certified or equivalent.
 - International standard Certifications

Note: Product Brochure, Catalogue and certificates must be attached with the Technical Bid

26.41 Solar Charge Controller (for Street / Road Lights)

- a. The charge controller must be suitable for the required battery voltage, auto voltage recognition feature and capable of charging OPzV & Lithium Ferrous Phosphate (LiFePO₄) Batteries
- b. The charge controller must be IP-67 rated or above for outdoor installation
- c. The charge controller must be Remote Controlled for parameter setting. The system must have the following feature:
 - Remote Parameter Setting and Monitoring
 - Remote control of the Lights (on/off, timer setting etc.)
- d. The charge controller must have MPPT Technology
- e. The charge controller must have at-least three stage Flexible dimming function (0-100%).
- f. The Maximum power point tracking (MPPT) efficiency should be minimum 97%.
- g. It must have temperature compensation for charging batteries in higher temperatures.
- h. Charge controller must have the following protections:
 - PV Short circuit
 - PV reverse polarity
 - PV over voltage
 - PV over current
 - Battery over charging
 - Battery over discharging
 - Battery reverse polarity protection
 - Load short circuit
 - Load overload protections
- i. It must have proper heat sink to dissipate excessive heat
- j. The charge controller must have protection for reverse flow of current through the PV modules
- k. Controller should have active port for GSM based communication for Remote Monitoring.
- l. Mid Night based timing controller will be preferred.
- m. The Solar Charge controller must have the following certification:
 - ISO 9001
 - CE Certified

Note: Product Brochure, Catalogue and certificates must be attached with the Technical Bid

26.42 Battery and Controller Box

- a. The battery box should be made of Hot Dipped Galvanized Sheet of average 80 Microns.
- b. The battery box must have vented compartment having inverted louvers.
- c. For Pole Mounted batteries Battery boxes must be made of minimum 16 SWG sheet and must have proper locking arrangement for protection against theft.
- d. For underground battery installation, the battery box should be made of minimum 16 SWG sheet and should be properly sealed to ensure protection against water. Proper cable glands and packing material should be used to ensure water proofing of the box.
- e. The battery and Controller Box should be at least IP65 ingress protection.

26.43 Electric Cable

The specifications of Electric cables are as under:

- a. Flexible copper cable of proper size along with MC-4 connectors (TUV Approved) from solar panel to charge controller and charge controller to battery as well as to light fixtures.
- b. The cables should be made of minimum 99.9% Pure copper cable

LIST OF APPROVED MANUFACTURERS (CIVIL WORKS)

(to be signed by the Bidder)

The Contractor should note that only material from those manufacturers specified in the list of approved manufacturers shall be allowed to be used on this Project. The Contractor shall submit literature/catalogue/samples etc. of all the items from each of the specified manufacturers to the Engineer who shall then decide and approve the sample and the manufacturers. Where the item involves any finishes such as paints, external coating, etc. the Contractor shall erect mock-up samples of the specified manufacturers for the selection and approval of the Engineer.

Onus lies with the Contractor for establishing the genuineness of any material/product/item for its make and origin as specified below:

S. No.	Materials	Manufacturer
1	Ceramic Tiles	Stile/ Shabbir, Master
2	Porcelain Tiles	RAK (UAE), Granitto (UAE), Niro Granite (Malaysia)
3	Paints & Varnish	ICI, Berger
4	Door Locks / Door closers	USA/ West European / Japanese Origin
5	Anti-Termite	Termidor, Biflex, Mirage, Tenekil, Termicure
6	Construction Chemicals	MBT, Sika and Fosroc or approved equivalent
7	UPvc Windows of Premium Quality with openable shutters, double glazing with imported locks, hinges and magnets complete in all respect	Germany, Tukey and China Origin
8	Precast Concrete Interlock Pavers	Tuff Pavers, Izhar, Envicrete, Hubcrete, Concrete Wizard
9	Chequered Tiles	Grand Works, Concrete Wizard, Envicrete or approved equivalent
10	False Ceiling including Suspension System complete in all respect	Daiken (Japan), Dampa (Denmark) & OWA (Germany)
11	Bricks for Facing/ Exposed Surfaces	33 trademark or approved equivalent
12	Lamination Board	Formite or approved equivalent.

Authorized Signature & Official Seal: _____

Name: _____

Date: _____

LIST OF APPROVED MANUFACTURERS FOR ITEMS/MATERIALS OF PLUMBING

S. No	ITEM		MANUFACTURER
1.	G.I. Pipe	i. ii. iii.	M/S International Industries Limited M/S Jamal Pipe Industries (Pvt) Limited M/S Bashir Pipe Industries (Pvt.) Limited
2.	G.I. Pipe Fittings	i. ii.	M/S. HE China M/S. TG China
3.	M.S. Pipes & Fittings	i. ii.	M/S Jamal Pipe Industries (Pvt) Limited M/S Haffaz
4.	C.I. Pipe And Fittings	i. ii.	M/S. Super Alpine Steel (Pvt.) Limited M/S. Teepu Supreme Spun Pipes
5.	Sanitary Fixtures	i. ii. iii.	M/S Porta (China) M/S. Asian Standard (China) M/S I.C.L.
6.	Kitchen Sink	i. ii. iii.	M/S Super Asia M/S Master M/S Atlas
7.	Sanitary Fittings	i. ii.	M/S Master M/S Sonex
8.	Valves	i.	M/S SCON Or Approved Equivalent.
9.	Gas Water Heaters	i. ii. iii.	M/S Singer M/S Ambassador M/S Corona
10.	Water Cooler	i. ii. iii.	M/S Mecco M/S Caravell M/S Comfort
11.	C.I. Covers with Frame & Roof Drains	i. ii.	M/S Super Alpine Steel (Pvt.) Limited M/S Teepu
12.	Fire Extinguishers	i.	M/S Haseen Habib Corporation (Pvt.) Ltd.
13.	UPvc Pipe and Fittings	i. ii. iii.	M/S Dadex Enternit Ltd. M/S Shafisons Engineering (Pvt.) Ltd. (Beta Pipes). M/S Vicplas
14.	Ppr Pipe & Fittings	i. ii. iii.	M/S Dadex M/S Shafisons Engineering (Pvt.) Ltd. (Beta Pipes). M/S Plasterm
15.	Water Filters	i. ii.	M/S So-Safe M/S Aqua Safe

Authorised Signature & Official Seal: _____

Name: _____

Date: _____

LIST OF RECOMMENDED MANUFACTURERS / BRANDS OF EQUIPMENT / MATERIALS

This list of recommended manufacturers/suppliers of different equipment/materials with brand names has been provided in order to establish a standard level of performance. The contractor shall provide and fix the equipment/materials of superior quality as indicated below or approved equivalent as per approval of the Engineer.

Sr. No.	EQUIPMENT/ MATERIALS	MANUFACTURERS / BRANDS
1.	LV and Control Cables and Wires (600/1000 V)	Pakistan Cables, Pioneer Cables, Newage Cables, Fast Cables
2.	PVC Conduit & Accessories	Beta, Popular, Galco
3.	Steel Conduit & Accessories	Hilal Industries, IIL, Jamal, Pioneer
4.	MCCBs, MCB Magnetic Contactors	Marlin Gerlin (MG) (France), Siemens (Germany), ABB (Italy), Legrand (France), Terasaki (Japan), Panasonic Green power (Japan), Telemecanique
5.	Relays and Timers	Finder (Italy), Inter (Turkey)
6.	LV Changeover Switch	Socomec (France), ABB (France/Germany), LG, Elcontrol (Italy) & Entus
7.	Voltmeter/Ammeters	Circular (Italy), Revalco (Italy), Inter (Turkey), Entes (Turkey)
8.	Current Transformer/Voltage Transformer	Circular (Italy), Revalco (Italy), Fico
9.	Back Boxes, Pull boxes etc.	Bosch, Milano, Legrand, Clipsal and ABB.
10.	Data Network Accessories and Communication Cable Trays	3 M, Amps, Crosheind, APC, Panduit.
11.	CCTV System	Bosch, Siemens, Honeywell, PELCO, Fike
12.	Fans	Pak., Royal, Climax, GFC
13.	Selector Switches/ Push button / switches / switch socket	Kraus & Naimer, ABB, Legrand, Clipsal Revalco (Italy) Bosch, Milano & Crosehind
14.	Indication Lamps	Legrand (France), Breter (Italy) ABB, Telemecanique
15.	Low Voltage Panel, MCC & ACP	SA Electric Concern, Elmetec, PEL, Bilal Switch Gear Al-Rehman Switchgear, Messi.
16.	DG Sets	Cater Pillar, FG Wilson, Siemens (GermanY), SDMO, Mitsubishi, Cummins power
17.	Terminal Blocks	Legrand (France), ABB, Phoenix, Cabour
18.	Road Light Poles	Jamal Pipe Industries, Bashir Pipe Industries and Lion Steel Industries
19.	Lighting	Philips, Thorn, Pierelite

SPECIAL PROVISION

NSI-I PROVIDING & LAYING OF UPVC PIPE 100 MM DIA

1.1 DESCRIPTION

The work consists of supplying, installing, and commissioning of all material and services of the complete conduits and pipes as specified herein, shown on the Drawings and/or as directed by the Engineer's Representative.

The Contractor shall get the prior approval of the layout from the Engineer's Representative at Site for exact route, location and position of the conduits and pipes.

1.2 GENERAL

The Contractor shall ensure exact location and route of conduit and pipes in coordination with other services as per site requirements and get the approval of Engineer's representative prior to execution of the work.

1.3 APPLICABLE STANDARD/CODES

Latest editions of the following standards/codes shall be applicable for the materials in scope of this Section:

- BS 6099 - PVC Conduits and Accessories
- BS 3595 - PVC Pipes and Accessories
- BS 4346 - Cement Solvent for Jointing

1.4 MATERIAL

1.4.1 uPVC Conduits and Accessories

The heavy gauge uPVC conduits and accessories conforming to BS6099 shall be generally used. The uPVC conduits and accessories of light gauge may be used on the project with the concurrence of the Engineer's Representative.

The uPVC bends, sockets, elbows, couplings etc. shall conform to the same specifications as for the conduits. The uPVC bends shall have enlarged ends to receive conduit without any reduction in the internal diameter at joint. Manufactured smooth bends shall be used where conduit changes direction. Bending of conduits by heating or otherwise will not be allowed in any situation. The use of sharp 90-degree bends and tees will not be allowed.

1.4.2 uPVC Pipe and Accessories

The pipe shall be rigid. All pipes shall be minimum Class D (Working pressure - 12 bar), unless otherwise stated on drawings. The buried uPVC

pipe should be able to withstand the external load acting upon it by continuous movement of heavy duty vehicles such as trucks, cranes, forklift, etc. Where pipe changes direction, manufactured smooth bends shall be used. Bending of pipes by heating or otherwise will be allowed in special cases only. Bending of pipes by heating shall be carried out by first filling the pipe with sand inside and then immediately removing the sand. The use of sharp 90-degree bends and tees will not be allowed. The bends shall conform to same specifications as given for uPVC conduits. For joining of pipe all precautions and procedures recommended by manufacturer shall be followed.

1.5 INSTALLATION

1.5.1 uPVC Pipe

Pipes shall be installed under roads and paved areas, at crossing with other services as shown on the Drawings and/or as directed by the Engineer's Representative. The depth of the pipe shall vary according to the conditions at site, and approval of Engineer's Representative shall be obtained prior to installation. In general, the pipes shall be installed underground at the following depths measured from the top of the pipe and or as directed by the Engineer's representative.

Under roads and paved surface	800 mm below the finished surface
When crossing other services	250-mm vertical clearance for the crossing length 500 mm horizontal clearance with CC protective cover

The trench of required dimensions shall be excavated and the bottom of trench cleaned and leveled. A four-inch thick bed of fine sand shall be provided before lying of uPVC pipes with proper alignment. Where two or more pipes are installed in the same trench the clearance between pipes shall not be less than two inches. After lying of pipe, the trench shall be backfilled with clean-screened earth in layer of four inches. Each layer shall be properly compacted. All joints shall be sealed adequately to prevent entry of foreign elements.

For crossing of major services, the uPVC pipes shall installed in trench of size as shown on drawings or as directed by the Engineer and will be covered with concrete class A as per drawings or as directed by the Engineer.

The installation of pipes shall be completed in all respects including its fixing at terminations, before cabling work is started. All sharp edges and burrs shall be removed by using reamer or any approved device. The pipe shall be thoroughly cleaned of dirt and dust from inside. The pipes shall be installed in proper co-ordination with other works.

501.6 MEASUREMENT AND PAYMENT

Measurement

Measurement shall be made for the number of running meters of pipes acceptably supplied and installed by the Contractor.

Payment

Payment shall be made for the total numbers of meters measured, as provided above, at the Contract unit price. The payment shall constitute full compensation for providing and completion of laying of uPVC pipes including jointing materials and accessories and all incidentals for completion of the work.

Pay Item No.	Description	Unit of Measurement
NSI-I	Providing & Laying of UPVC Pipe 100 mm Dia	M

Khyber Pakhtunkhwa Integrated Tourism Development Enterprise - KITE
Package-02: Upgradation of Mankial – Beda Sarai Road (Length = 22.00 Km)

LIST OF LABORATORY EQUIPMENT TO BE PROVIDED BY THE CONTRACTOR

S.No	Description	Make	Qty.
SIEVE ANALYSIS			
1	S.S. Sieves 12 " dia (Non Magnet) of size 3 " ,2-1/2" ,2" ,1-1/2" , 1" , 3/4 " ,1/2" ,3/8" .# 4 ,Pan and cover (Set comprising of 10 Sieves)	Europe	1
2	8" dia Sieves of size 4, 8,10, 16, 30, 40, 50, 80, 100, 200 & Pan and cover.	Europe	11
3	Wet Washing Sieve 8" dia SS Frame ,4" height (Non Magnet) , Sieve # 200.	Europe	2
4	Wet Washing Sieve 8" dia SS Frame ,4" height (Non Magnet) , Sieve # 200.	KBL	2
5	Sample splitter 2" c/w 3 refilling box & Scoop.	PAK	1
6	Sample splitter 3/4" c/w 3 refilling box & Scoop.	PAK	1
CASAGRANDA APPARATUS			
7	Liquid Limit Set. As per ASTM D-4318 a) Liquid Limit Device Motorized b) Grooving Tool. c) China dish 250 cc d) Spatula 4" e) Glass Cylinder 100 ml f) Moisture Can 70 mm * 25 mm (Set of 12)	PAK.	1
8	Plastic Limit Set As per ASTM D-4318 a) Plastic Limit Plate. b) China Dish c) Spatula 4" d) Glass Cylinder 25 ml e) Moisture Can 50 mm * 25 mm (Set of 12) f) Rod comparator. g) wooden box.	PAK.	1
9	Shrinkage Limit Set As per ASTM D-427. a) Shrinkage Dish 45mm * 12.5mm b) Crystallising Dish 57mm * 31mm c) Shrinkage Prong Plate. d) Evaporating Dish. e) Spatula f) Glass Cylinder 25ml g) wooden box.	PAK.	1
10	Wash Bottle. 500ml	China	3
SOIL COMPACTION TEST SET			
11	Modified Compaction Hammer. Weight 10 lbs ,Fall height 18"	PAK.	2
12	Modified Compaction Mould 6" dia.	PAK.	2
13	Spatula 100mm	PAK.	2
14	Mixing Tray 24" * 24" * 3"	PAK.	2
15	Straight Edge. 300 * 25 * 3mm	PAK.	2
16	Scoop Alu. Large.	PAK.	2
17	Mixing Spoon.	PAK.	2
18	Rubber Mallet Large.	China	2
LABORATORY CBR TEST SET			
19	CBR Machine composed by:- a) Motorized Frame,Capacity 50 KN, Speed 1.27mm/min b) Proving Ring 50KN.(Factor Less Than 4.5kg/Div) c) Penetration Piston d) Penetration Gauge. e) Bracket & Adoter for CBR Penetratin.	TURKEY	1
20	CBR Mould 6" dia with collar and Perforated Base plate.(Galvanized)	PAK	6
21	Swell Plate (Perforated with adjustable stem)	PAK	6

22	Tripod attachment for CBR	PAK	6
23	Swell Gauge 10mm * 0.01mm	Japan	6
24	Surcharge Weight Annular (Galvanized)	PAK	6
25	Surcharge Weight Slotted (Galvanized)	PAK	6
26	Spacer Disc with T handle (Galvanized)	PAK	1
27	Straight Edge.	PAK	1
28	Filter paper 6" dia	Whatman	1
29	CBR Soaking Tank, For 6pcs CBR mould , hard plastic. Size 500 * 700 * 400mm	Turkey	1
FIELD DENSITY TEST SET			
30	Sand cone set complete with the followings:- a) Sand cone 6" dia. b) Steel Base Plate. c) Plastic Bottle.	PAK	1
31	Spoon Large.	PAK	1
32	Polythene Bag 12" * 16". kg	PAK	2
33	Polythene Bag 16" * 22". kg	PAK	2
34	Chisel 12"	PAK	1
35	Hammer 2.2 lbs.	PAK	1
36	Digital Balance 30kg * 1g	PAK	1
37	Wooden Box for Field Digital Balance.	PAK	1
38	Sieve 8" dia of Size 3/4"	PAK	1
39	Sieve 8" dia wire mesh # 16	PAK	1
40	Sieve 8" dia wire mesh # 30	PAK	1
41	Sand Calibration Measure 6". Alu	PAK	1
42	Speedy Moisture Tester 20g ,20% Principal:-Forney, USA.	LA-3405	1
43	Calcium Carbide.450g / Tin.	PAK	2
CONCRETE			
44	Automatic Digital Compression Testing Machine , Capacity 2000KN c/w Distance Pieces	TURKEY	1
45	Curing Tank Heater.	PAK	2
46	Trays (G.I.Sheet) Size 36" * 36" * 4". (Special for Concrete ,16G Sheet Thickness)	PAK	1
47	Cylinder Mould 6" dia, M.S. Pipe, Galvanized	PAK	12
48	Tamping Rod for Cylinders. 16mm * 600mm	PAK	1
49	Spanner for Cylinders.	PAK	2
50	Cylinder capping Device for 6" dia Moulds.	PAK	1
51	Concrete capping compound.Kg	PAK	100
52	Capping Warmer.	PAK	1
53	Retainer SS for 6" dia Cylinder.	PAK	1
54	Pad 6" dia for Cylinders.	PAK	10
55	Slump Test Apparatus. a) Slump Cone dia 4" & 8" ,height 12" (M.S.) 2mm thickness ,Painted b) Steel Base plate. 2mm thickness ,Painted c) Plastic Funnel d) Tamping Rod, 5/8" dia * 24",Galvanized	PAK	3
56	Straight Edge. 300 * 25 * 3mm	PAK	1
57	Dial thermometer 50°C	USA	2
58	Air Entrainment Meter.	USA	1
59	Motorized Concrete Drum mixer, Drum Capacity 210L.	China	1
AGGREGATE			
60	Los Angeles Abrasion Machine composed by:- Digital Los Angeles Abrasion Machine ASTM rotates on its horizontal axis at 31-33 rpm,Digital Counter to stop machine at required count. Abressive charges Set (Stainless Steel) weight 5000g ± 25g , set of 11 Pcs. Receiving Tray Galvanized SS Sieve 12" dia # 12	PAK	1
61	Sand Absorption cone & Tamper.	PAK	1
62	Density Basket, SS , 8" dia * 8" height	PAK	1

63	Flakiness Gauge.	PAK	1
64	Elongation Gauge.	PAK	1
65.A	Unit weight ,5 L ,10L , 14L , 28L	PAK	1
65.B	Tamping Rod.	PAK	1
66	Specific Gravity Apparatus comprises of:-	PAK	1
a)	Buoyancy Balance 15000g *0.1g		1
b)	Frame for Buoyonce Apparatus		1
c)	Density Tank		1
d)	Density Basket. Galvanized, 8" dia * 8" height		1
e)	Cradel.		1
67	Specific Gravity Bottle. 25ml	china	6
68	Specific Gravity Bottle. 50ml	china	6
69	Sand Equivalet set	TURKEY	1
70	Stock Solution.	PAK	2
CEMENT			
71	Flow Table Hand operated complete with Brass Mould Cup.	PAK	1
72	Vicat Apparatus composed by:- Vicat Frame ASTM Mould Initial Needle Final Needle Glass Plate	PAK	1
73	Soundness of Cement.	PAK	1
a)	Le Chattlier Mould.		6
b)	Glass Plate.		6
c)	100 g weight.		6
d)	Plastic Stand		1
f)	Le Chattlier waterbath		1
74.a	Blain Apparatus.	PAK	1
74.b	Standard Refrence Cement.	Europe	2
74.c	Manometer Liquid.	Europe	1
GENERAL LAB EQUIPMENT			
75	Laboratory oven, 120 L capacity, ambient to 200°C, PID digital control system, over temperature protection, fan circulated, stainless steel interior, powder coated exterior, isolated double wall construction, gasket single door, heating elements designed into air channels, 2pcs. adjustable shelves. 220-240V, 50-60 Hz, 1ph.	TURKEY	1
76	Laboratory oven, 250 L capacity, ambient to 200°C, PID digital control system, over temperature protection, fan circulated, stainless steel interior, powder coated exterior, isolated double wall construction, gasket single door, heating elements designed into air channels, 3pcs. adjustable shelves. 220-240V, 50-60 Hz, 1ph.	TURKEY	1
77	Hot plate. 150mm dia	Annex	1
78	Mixing Bowl.8" dia.	PAK	6
79	Mixing Bowl.10" dia.	PAK	6
80	Digital Mini Thermometer -50 to 250°C,	China	6
81	Digital thermometer complete with Probe.	Taiwan	1
82	Digital Balance Capacity 1100g * 0.01g	PAK	1
83	Digital Balance Capacity 15000g * 0.1g	PAK	1
84	Digital Balance Capacity 30Kg * 1g	PAK	1
85	Digital Balance , Capacity 150 Kg, Minium Sensivity 100g, Resolution 10g, Platform size 18" * 18"	PAK	1
86	Stop watch	Q & Q	1
87	Vernier caliper 300mm	Tricycle	1
88	Digital Maximum - minimum thermometer.	China	1
89	Moisture can with cover size 90mm * 55mm	KBL	12
90	Moisture can with cover size 70mm * 45mm	KBL	6
91	Moisture can with cover size 70mm * 25mm	KBL	6
92	Moisture can with cover size 100mm * 75mm	KBL	6
93	Moisture can with cover size 50mm * 25mm	KBL	6
94	Scoop (Alu.) large.	KBL	3

95	Scoop (Alu.) small.	KBL	3
96	Brass Brush	KBL	6
97	Wire Brush ,Coarse	KBL	6
98	Brush ,Fine 2"	KBL	6
99	Trays (G.I.Sheet) Size 9" * 12" * 2"	KBL	3
100	Trays (G.I.Sheet) Size 12" * 12" * 3"	KBL	3
101	Trays (G.I.Sheet) Size 12" * 18" * 3"	KBL	3
102	Trays (G.I.Sheet) Size 18" * 18" * 3"	KBL	3
103	Trays (G.I.Sheet) Size 24" * 24" * 3"	KBL	3
104	Mortar Porcelain 150 mm with pestle.	Local	1
105	Rubber Gloves.	Local	1
106	Asbestos Gloves.	Local	1
107	Leather Gloves.	Local	1
108	Plastic Cylinder 100 ml	Local	1
109	Plastic Cylinder 250 ml	Local	1
110	Plastic Cylinder 500 ml	Local	2
111	Plastic Cylinder 1000 ml	Local	2
112	Glass Cylinder 100 ml	Bomax	2
113	Glass Cylinder 250 ml	Bomax	2
114	Glass Cylinder 500 ml	Bomax	2
115	Glass Cylinder 1000 ml	Bomax	2
116	Sodium Sulphate Anhydrous 1 kg / pack	Imported	1
117	Volumetric Flask 500ml	Bomax	2
118	Spatula 100mm blade (Wooden Handle)	Local	3
119	Spatula 150mm blade (Wooden Handle)	Local	3
120	Spatula 200mm blade (Wooden Handle)	Local	3
121	Glass Beaker 250ml	Bomax	2
122	Glass Beaker 500ml	Bomax	2